

Helios 600GR

SPECIFICATIONS

ursa

FOR INFORMATION, CONTACT US
INFO@URSALIGHTING.COM
TEL: +1 (510) 687-1128
URSALIGHTING.COM



FEATURES

- Advanced 3-PAD COB LED technology
- Mounting bracket included, mounting hooks optional
- Cold forged heatsink core with patented Forging Fit Technology capable of passively cooling up to 600W
- Designed for greenhouse and commercial applications
- Lighting Footprint : 4'x4'
- Waterproof, full IP65 rating
- Optimal Hang Height: 24 - 36 in.
- Durable surface finish to protect against corrosion and high-humidity environments

01

MECHANICAL SPECIFICATIONS

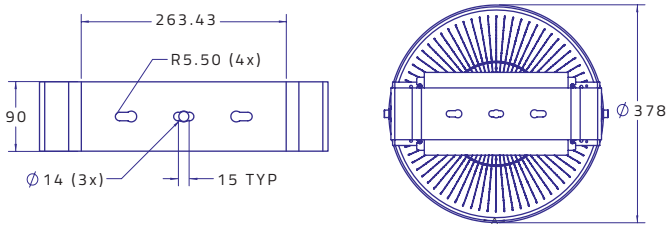
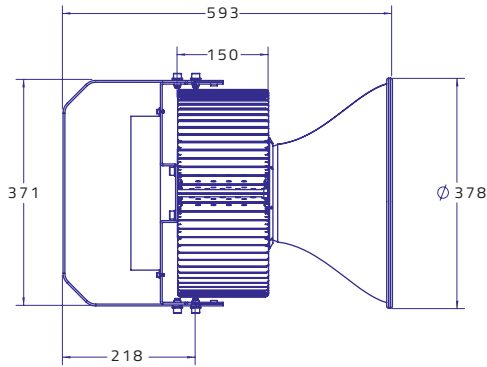

Dimensions (mm)	378 x 371 x 593
Weight	33.1 lbs (15 kg)
Input Voltage	90 - 305 VAC Standard 347V (Option) 480V (Option)
Drive Current	11.2A
Output Voltage	54V
Power Factor	0.98 @ 115 VAC
Operation Temperature	-20°C to 40°C (-4°F to 104°F)

Material	
Heatsink Core	Al 1070
Fins	Al 1050
Reflector	Al 1090
Lens	Tempered Glass
Brackets	Iron / 304 SS

SPECTRUM GRAPH

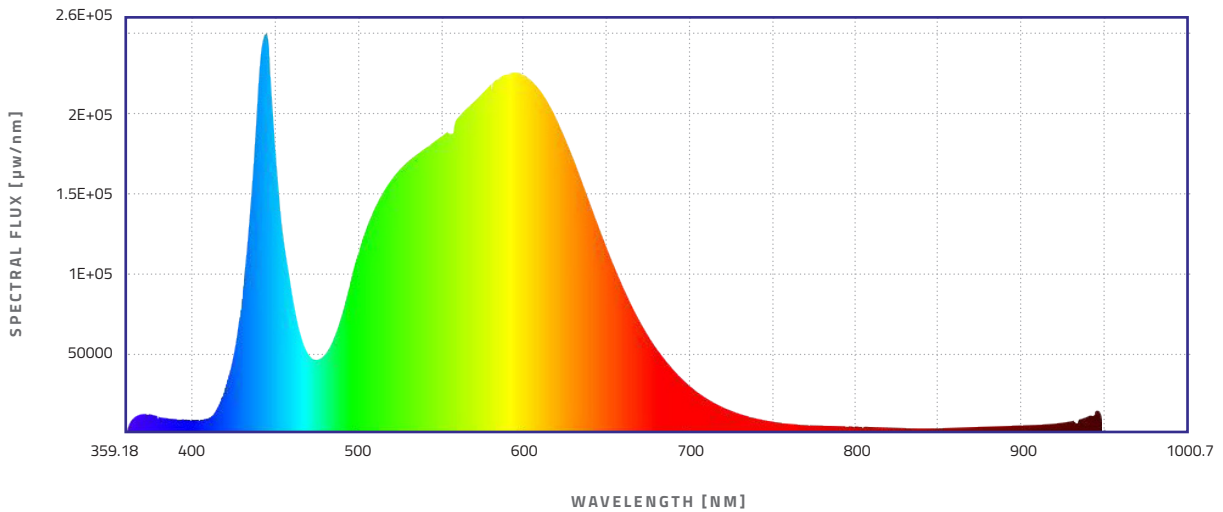

PRODUCT CODE

HS0600A-R604080-THD6

02

PPFD MEASUREMENTS

4' X 4' SINGLE CANOPY DEMONSTRATION

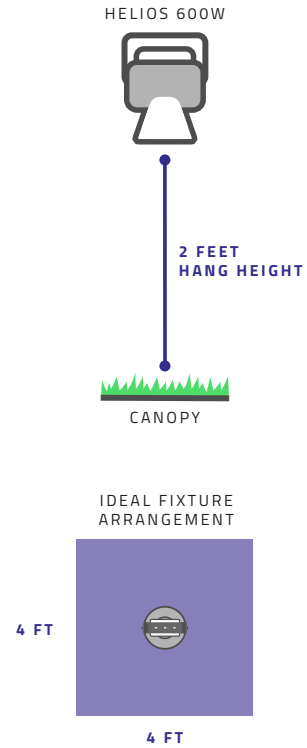
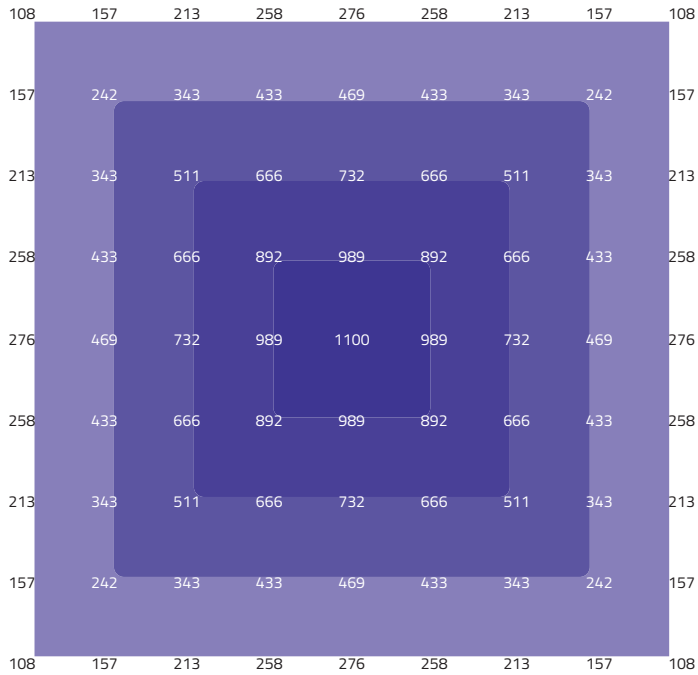

4' X 16' SINGLE-ROW DEMONSTRATION (VERTICAL GROW)

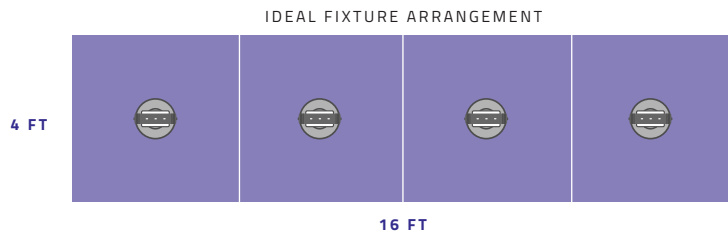
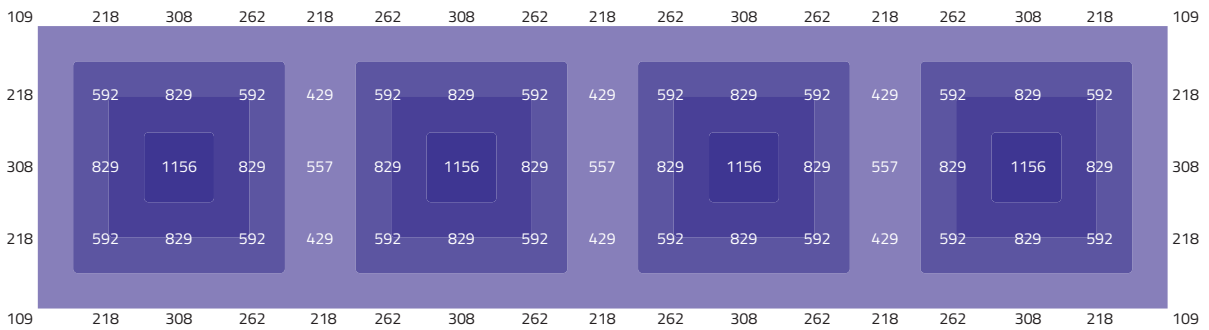

02

PPFD MEASUREMENTS

12' X 16' LARGE CANOPY DEMONSTRATION (COMMERCIAL ROOM)

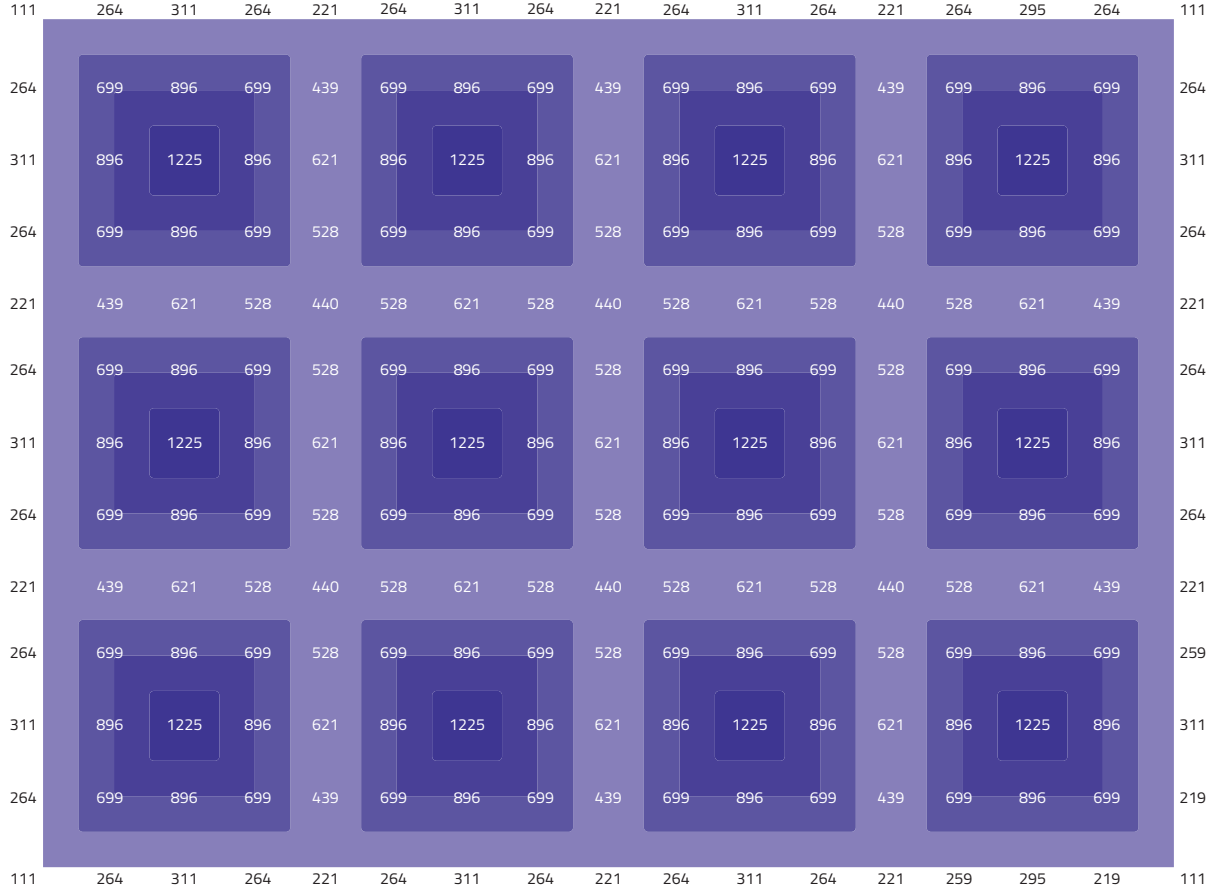

IDEAL FIXTURE ARRANGEMENT

