











- A

X8
- G

X8
- B

X4
- C

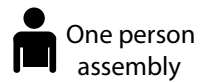
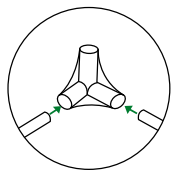
X4
- F

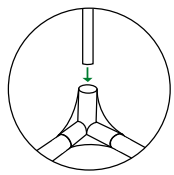
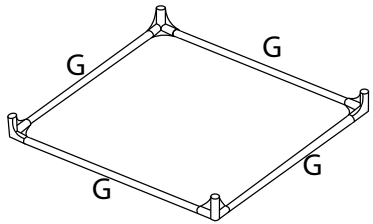
X4
- H

X1
- I

X1
- E

X1
- D

X1

 X16





Step 1



Step 2

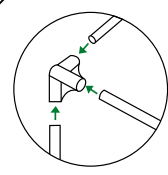
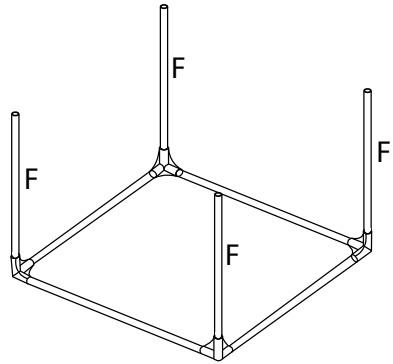

Step 3

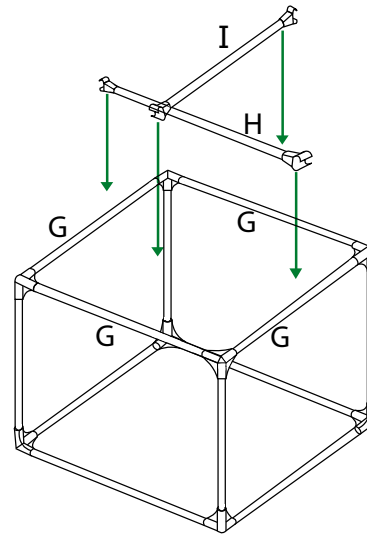

Top Complete

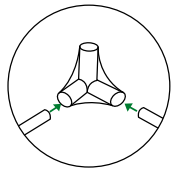
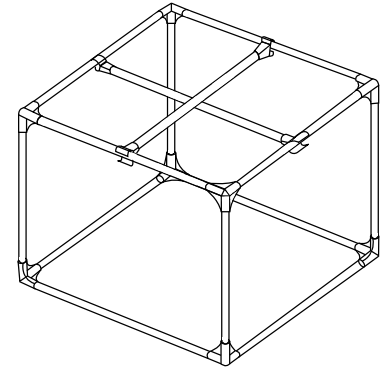

Step 1

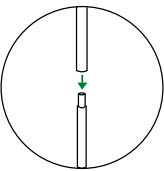
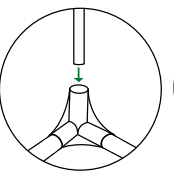
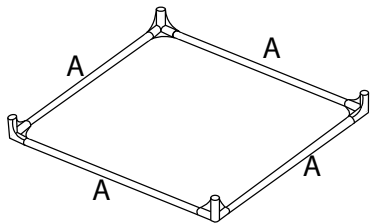

Step 2

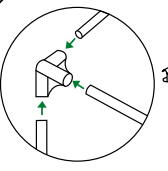
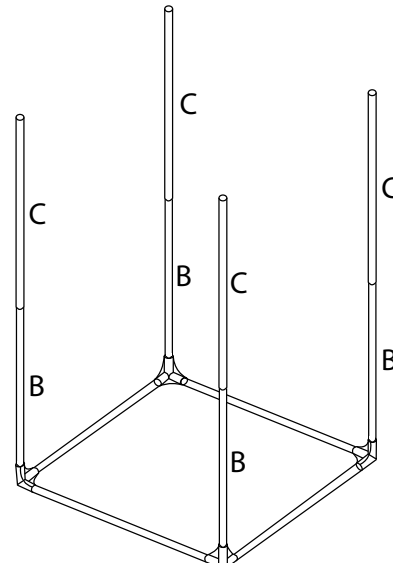

Step 3

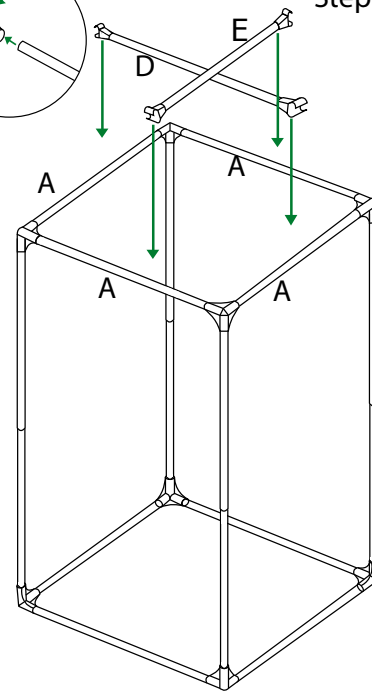

Bottom Complete

