

VERVE CAM VERVE CAM+

Quick Start Guide

For detailed operating instructions, refer to the User Manual which can be downloaded from www.verve.life



Your Camera

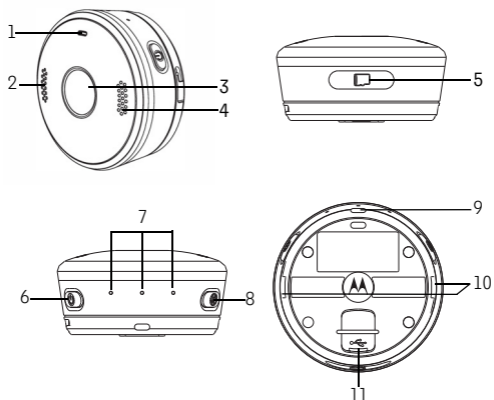

1. Camera LED (Blue / Red)
2. Speakers
3. Camera Lens
4. Microphone
5. micro SD Card* Slot and Reset Button (*micro SD Card is not included.*)
6. Power / Mode Button
7. Mode Indicators (Photo / Video / Streaming)
8. Shutter / Select Button
9. Lanyard Hole
10. Locking Holes
11. micro-USB socket

* supports microSDHC cards up to 32GB.

Accessories included with Verve CAM+

Waterproof Case • Clip Mount • Bumper & lanyard • Universal Mount

Additional accessories for other home or outdoor activities can be purchased separately from www.verve.life

Step 1: Setting up

Charge the Battery

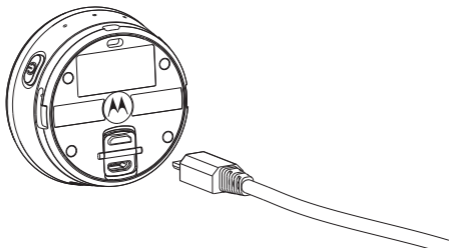

Connect the power adapter to an electrical outlet and insert the plug into the micro-USB socket on the underside of the Camera. Only use the power adapter (5V 1A) with the micro-USB plug.

Note: *If the Camera is OFF, the LED indicator lights up in red when charging and goes off when the battery is fully charged. It takes about 6 hours to fully charge the battery for the first time.*

Power On & Off the Camera

To power ON the Camera, hold down the **POWER / MODE** button  for 3 seconds. The LED indicator lights up in blue.

To power OFF the Camera, hold down the **POWER / MODE** button  for 3 seconds. You will hear a voice prompt indicating that the Camera is powering off before the LED indicator goes off.

Step 2: Connecting Devices

Download & Install *Hubble Connect for VerveCam* app

Download & Install *Hubble Connect for VerveCam* app on your smartphone for free at the App Store[®] or Google Play[™].

Pair the Camera with your Smartphone

1. Run *Hubble Connect for VerveCam* app on your smartphone.
2. Follow the in-app instructions to connect the Camera with your smartphone.
3. The Camera ID is printed on the back of the Camera, and the default password for your Camera is “00000000”.

Please take note of the following minimum system requirements:











Smartphone: iOS 7 (and higher) or Android[™] 4.3 (and higher)

Wi-Fi[®] requirements:

At least 0.6 Mbps upload bandwidth per camera.

Test your Internet speed at: [http://
www.speedtest.net/](http://www.speedtest.net/)

Basic Operation of your Camera

To	Do this
Take photo	<ol style="list-style-type: none">1. Press the POWER / MODE button  repeatedly until the photo mode indicator  lights up.2. Press the SHUTTER/SELECT button  to take photo.
Record Video	<ol style="list-style-type: none">1. Press the POWER / MODE button  repeatedly until the video mode indicator  lights up.2. Press the SHUTTER/SELECT button  to start recording.3. Press the SHUTTER/SELECT button  again to stop recording.
Record Time-lapse video	<ol style="list-style-type: none">1. Run Hubble Connect for VerveCam app on your smartphone and make sure that the Camera is connected.2. In the viewfinder screen, tap to select Time Lapse mode  on the bottom panel.
Start Loop Recording	<ol style="list-style-type: none">1. Run Hubble Connect for VerveCam app on your smartphone and make sure that the Camera is connected.2. In the viewfinder screen, tap to select Loop Record mode  on the bottom panel.
Start Livestream	<ol style="list-style-type: none">1. Run Hubble Connect for VerveCam app on your smartphone and make sure that the Camera is connected.2. In the viewfinder screen, tap to select Livestream mode  on the bottom panel.3. Follow the in-app instructions to setup livestream.
View Photos and Videos	<ol style="list-style-type: none">1. Run Hubble Connect for VerveCam app on your smartphone and make sure that the Camera is connected.2. Go to Camera roll mode .

Transfer files from the Camera to your Computer

Power on the Camera and make sure that the Camera is disconnected from **Hubble Connect for VerveCam** app.

To disconnect the Camera from the app, you can close the app or turn off the Camera and turn it on again.

Connect the Camera to your computer's USB port. Your computer will recognize the Camera as a mass storage device. You can then drag and drop your files, just like other external devices.

To exit mass storage mode, unplug the USB cable.

Help & more

If your product is not working properly....

1. Read this Quick Start Guide or the User Manual.
2. Visit our website: www.verve.life/contact
3. Contact Customer Service at

US and Canada 1-888-331-3383

E-mail: support@verve.life

Consumer Products and Accessories Limited Warranty

Thank you for purchasing this Motorola branded product manufactured under license by Binatone Electronics International LTD ("BINATONE").

What Does this Warranty Cover?

Subject to the exclusions contained below, BINATONE warrants that this Motorola branded product ("Product") or certified accessory ("Accessory") sold for use with this product that it manufactured to be free from defects in materials and workmanship under normal consumer usage for the period outlined below. This Warranty is your exclusive warranty and is not transferable.

Who is covered?

This Warranty extends only to the first consumer purchaser, and is not transferable.

What will BINATONE do?

BINATONE or its authorized distributor at its option and within a commercially reasonable time, will at no charge repair or replace any Products or Accessories that does not conform to this Warranty. We may use functionally equivalent reconditioned/ refurbished/ pre-owned or new Products, Accessories or parts.

What Other Limitations Are There?

ANY IMPLIED WARRANTIES, INCLUDING WITHOUT LIMITATION THE IMPLIED WARRANTIES OF MERCHANTABILITY AND FITNESS FOR A PARTICULAR PURPOSE, SHALL BE LIMITED TO THE DURATION OF THIS LIMITED WARRANTY, OTHERWISE THE REPAIR OR REPLACEMENT PROVIDED UNDER THIS EXPRESS LIMITED WARRANTY IS THE EXCLUSIVE REMEDY OF THE CONSUMER, AND IS PROVIDED IN LIEU OF ALL OTHER WARRANTIES, EXPRESS OR IMPLIED. IN NO EVENT SHALL MOTOROLA OR BINATONE BE LIABLE, WHETHER IN CONTRACT OR TORT (INCLUDING NEGLIGENCE) FOR DAMAGES IN EXCESS OF THE PURCHASE PRICE OF THE PRODUCT OR ACCESSORY, OR FOR ANY INDIRECT, INCIDENTAL, SPECIAL OR CONSEQUENTIAL DAMAGES OF ANY KIND, OR LOSS OF REVENUE OR PROFITS, LOSS OF BUSINESS, LOSS OF INFORMATION OR OTHER FINANCIAL LOSS ARISING OUT OF OR IN CONNECTION WITH THE ABILITY OR INABILITY TO USE THE PRODUCTS OR ACCESSORIES TO THE FULL EXTENT THESE DAMAGES MAY BE DISCLAIMED BY LAW.

Some jurisdictions do not allow the limitation or exclusion of incidental or consequential damages, or limitation on the length of an implied warranty, so the above limitations or exclusions may not apply to you. This Warranty gives you specific legal rights, and you may also have other rights that vary from one jurisdiction to another.

Products Covered	Length of Coverage
Consumer Products	One (1) year from the date of the products original purchase by the first consumer purchaser of the product.
Consumer Accessories	Ninety (90) days from the date of the accessories original purchase by the first consumer purchaser of the product.
Consumer Products and Accessories that are Repaired or Replaced	The balance of the original warranty or for Ninety (90) days from the date returned to the consumer, whichever is longer.

Exclusions

Normal Wear and Tear. Periodic maintenance, repair and replacement of parts due to normal wear and tear are excluded from coverage.

Batteries. Only batteries whose fully charged capacity falls below 80% of their rated capacity and batteries that leak are covered by this Warranty.

Abuse & Misuse. Defects or damage that result from: (a) improper operation, storage, misuse or abuse, accident or neglect, such as physical damage (cracks, scratches, etc.) to the surface of the product resulting from misuse; (b) contact with liquid, water, rain, extreme humidity or heavy perspiration, sand, dirt or the like,

extreme heat, or food; (c) use of the Products or Accessories for commercial purposes or subjecting the Product or Accessory to abnormal usage or conditions; or (d) other acts which are not the fault of MOTOROLA or BINATONE, are excluded from coverage.

Use of Non-Motorola branded Products and Accessories. Defects or damage that result from the use of Non-Motorola branded or certified Products or Accessories or other peripheral equipment are excluded from coverage.

Unauthorised Service or Modification. Defects or damages resulting from service, testing, adjustment, installation, maintenance, alteration, or modification in any way by someone other than MOTOROLA, BINATONE or its authorised service centers, are excluded from coverage.

Altered Products. Products or Accessories with (a) serial numbers or date tags that have been removed, altered or obliterated; (b) broken seals or that show evidence of tampering; (c) mismatched board serial numbers; or (d) nonconforming or non-Motorola branded housings, or parts, are excluded from coverage.

Communication Services. Defects, damages, or the failure of Products or Accessories due to any communication service or signal you may subscribe to or use with the Products or Accessories is excluded from coverage.

How to Obtain Warranty Service or Other Information?

To obtain service or information, please call:

US and Canada 1-888-331-3383

E-mail: support@verve.life

You will receive instructions on how to ship the Products or Accessories at your expense and risk, to a BINATONE Authorized Repair Center.

To obtain service, you must include: (a) the Product or Accessory; (b) the original proof of purchase (receipt) which includes the date, place and seller of the Product; (c) if a warranty card was included in your box, a completed warranty card showing the serial number of the Product; (d) a written description of the problem; and, most importantly; (e) your address and telephone number.

These terms and conditions constitute the complete warranty agreement between you and BINATONE regarding the Products or Accessories purchased by you, and supersede any prior agreement or representations, including representations made in any literature publications or promotional materials issued by BINATONE or representations made by any agent employee or staff of BINATONE, that may have been made in connection with the said purchase.

Regulatory Compliance Information

This device complies with Part 15 of the FCC Rules. Operation is subject to the following two conditions: (1) this device may not cause harmful interference, and (2) this device must accept any interference received, including interference that may cause undesired operation.

WARNING: Changes or modifications, to this equipment not expressly approved by the party responsible for compliance could void the user's authority to operate the equipment.

NOTE: This equipment has been tested and found to comply with the limits for a Class B digital device, pursuant to Part 15 of the FCC Rules. These limits are designed to provide reasonable protection against harmful interference in a residential installation. This equipment generates, uses and can radiate radio frequency energy and, if not installed and used in accordance with the instructions, may cause harmful interference to radio communications. However, there is no guarantee that interference will not occur in a particular installation. If this equipment does cause harmful interference to radio or television reception, which can be determined by turning the equipment off and on, the user is encouraged to try to correct the interference by one or more of the following measures:

- Reorient or relocate the receiving antenna.
- Increase the separation between the equipment and receiver.
- Connect the equipment into an outlet on a circuit different from that to which the receiver is connected.
- Consult the dealer or an experienced radio/TV technician for help.

Specific Absorption Rate (SAR) Information

This device meets the government's requirements for exposure to radio waves. This device is designed and manufactured not to exceed the emission limits for exposure to radio frequency (RF) energy set by the Federal Communications Commission of the U.S. Government. The exposure standard for wireless devices employs a unit of measurement known as the Specific Absorption Rate, or SAR. The SAR limit set by the FCC / by the RSS-102 is 1.6 W/kg. Tests for SAR are conducted using standard operating positions accepted by the FCC with the device transmitting at its highest certified power level in all tested frequency bands. Although the SAR is determined at the highest certified power level, the actual SAR level of the device while operating can be well below the maximum value. This is because the device is designed to operate at multiple power levels so as to use only the power required to reach the network. In general, the closer you are to a wireless base station antenna, the lower the power output. While there may be differences between the SAR levels of various devices and at various positions, they all meet the government requirement.

In general, the closer you are to a wireless base station antenna, the lower the power output. While there may be differences between the SAR levels of various devices and at various positions, they all meet the government requirement.

Industry Canada

This device complies with Industry Canada licence. Operation is subject to the following two conditions: (1) This device may not cause interference, and (2) This device must accept any interference, including interference that may cause undesired operation of the device.

Le présent appareil est conforme aux CNR d'Industrie Canada applicables aux appareils radio exempts de licence. L'exploitation est autorisée aux deux conditions suivantes : (1) l'appareil ne doit pas produire de brouillage, et (2) l'utilisateur de l'appareil doit accepter tout brouillage radioélectrique subi, même si le brouillage est susceptible d'en compromettre le fonctionnement.



www.motorolahome.com
www.verve.life

Manufactured, distributed, or sold by Binatone Electronics International LTD., official licensee for this product. MOTOROLA and the Stylized M Logo are trademarks or registered trademarks of Motorola Trademark Holdings, LLC. and are used under license. Apple logo is a trademark of Apple Inc., registered in the U.S. and other countries. App Store is a service mark of Apple Inc. Google Play and Android are trademarks of Google Inc. All other trademarks are the property of their respective owners. © 2016 Motorola Mobility LLC. All rights reserved.



US_LIN Version 1.0
Printed in China

Model number: CA001