

Operation Guide CT32

Radio(())Thermostat

Radio Thermostat Company of America

The CT32 communicating thermostat operates via a high-quality, easy-to-use touch screen. To set or adjust your CT32, simply touch your finger firmly to the screen. The screen will automatically light up and you will hear a “beep.” Do not use a sharp or metallic device; it will scratch the screen.

To open top and bottom covers, rotate the cover toward the wall. This will expose the battery compartment on the bottom and the wire terminals on the top.

Statement of use: 100% Compatible with all popular residential HVAC systems; 24VAC single, two stage conventional heating systems (gas/oil/electric), heat pumps with up to two stages of heat and two stage auxiliary heat(electric or fossil), zoned forced air and zoned hot water (2 or 3 wire), millivolt systems (with a 12-24 AC or DC source), one or two stage cooling, and hybrid systems.

1209-001-004

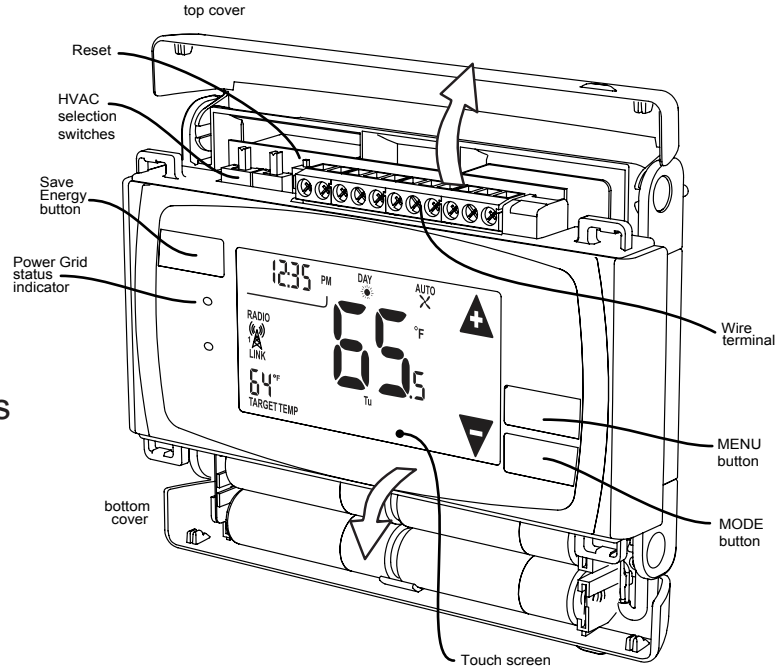

ENGLISH

OPERATION

Control Screens

HOME Screen

Before you operate the CT32 please get familiar with these basic control screens. All the CT32 functions are accessed through these screens: HOME, MENU, and MANUAL. The CT32 touch screen technology allows you to select (by touching) an item and change it using the +/- arrows or the time arrows.

The **HOME** screen is displayed when the unit is operating. Touching the HOME icon  on another screen will always return you to this screen.

To set a Mode:
 Press the mode button on the front. The CT32 will step through the modes HEAT, OFF, COOL, OFF, AUTO, OFF in order.
 When in OFF mode you can touch the OFF to return to the previous mode.

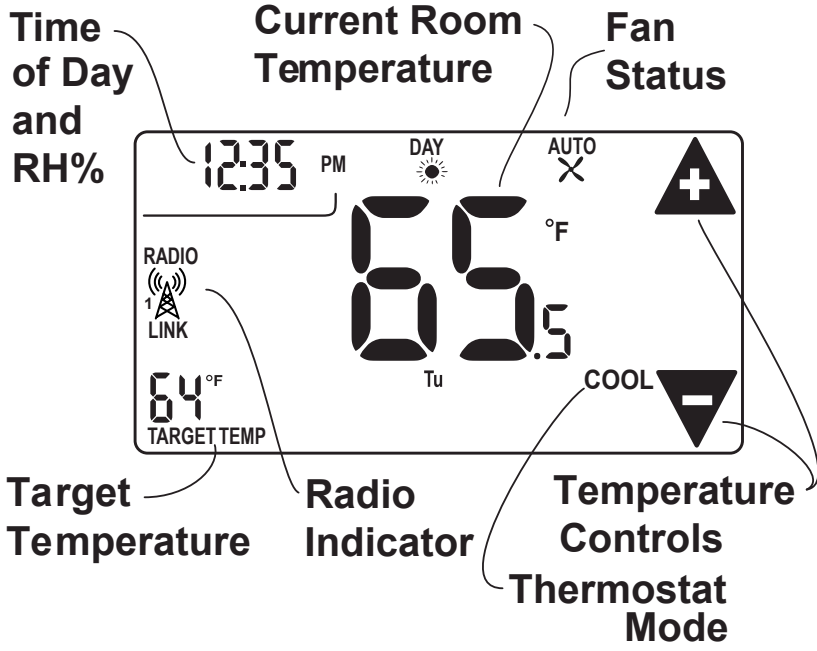

MENU Screen The **MENU** screen is the gateway to many functions or settings of the CT32. It is displayed when you press the MENU button. [See page 9 for details]

Set Time
 Touch this area to set the time of day. Left arrow goes back, right arrow goes forward.

DAY of the week set

Lock Program
 Touch for 5 sec to lock or unlock.

Set °C -°F
 Touch this to set temp display units

Filter timer
RADIO icon
 Shows radio status and connection

Differential to set for 2nd Stage start.

Temperature
 Swing set

Calibration control
 Use this to calibrate your LCD display match to another thermometer

RECOVERY
 FAST or ECON for multi-stage systems.

PROGRAM
 Touch this to set-up a Heating or Cooling schedule.

Chirp set
 Touch this to turn the audible chirp on and off

Return to **HOME** screen.

HVAC SETUP
 Touch this in OFF mode to configure the unit to work with your HVAC system

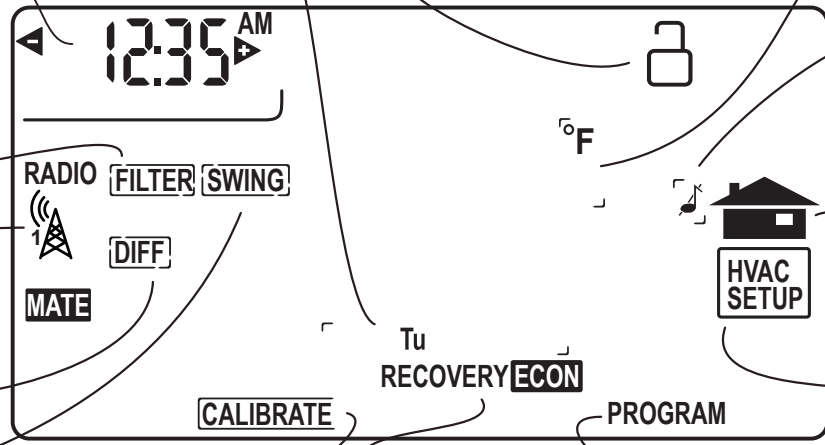

PROGRAM Screen

The stand alone **PROGRAM** screen sets the CT32 control for your home HVAC system without using a remote system. You access this screen from the MENU screen. For Manual control see page 5.

Set Time Slot

Touch this area to set the Time Slot you want to program.

Set Program Time

Touch this area to set the time of day you want each time period to start. Left arrow goes back, right arrow goes forward. [Touch and hold for fast set.]

Copy Touch this area to copy current day's program to the next day.

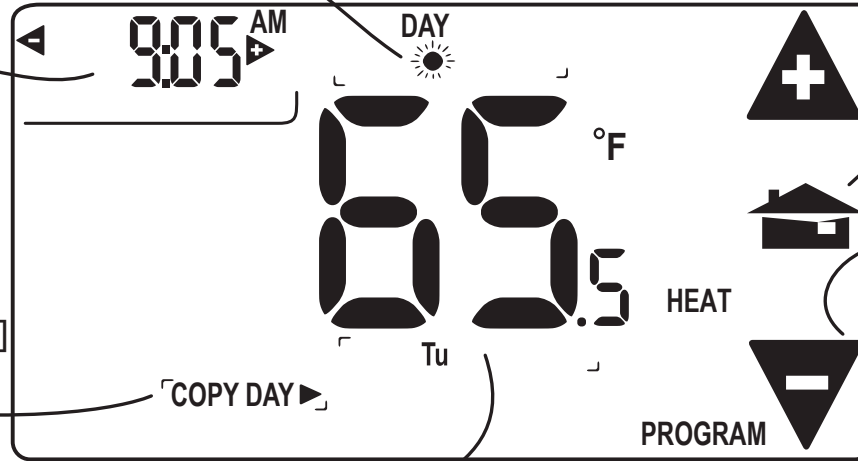

Return HOME When programming is complete touch this to run your program and return to the HOME screen.

Set Program Day Touch this area to set the day of the week you want to program.

Temp Up / Temp Down Touch these to raise and lower each Target Temp. [Touch and hold for fast set.]

MANUAL Screen

The **Manual** control screen is where you can make temporary changes to your CT32's operation. From the HOME screen, touch the main temperature display to use this screen. This temporary change in target will revert to the programmed target at the next time slot. [See page 12 for details]

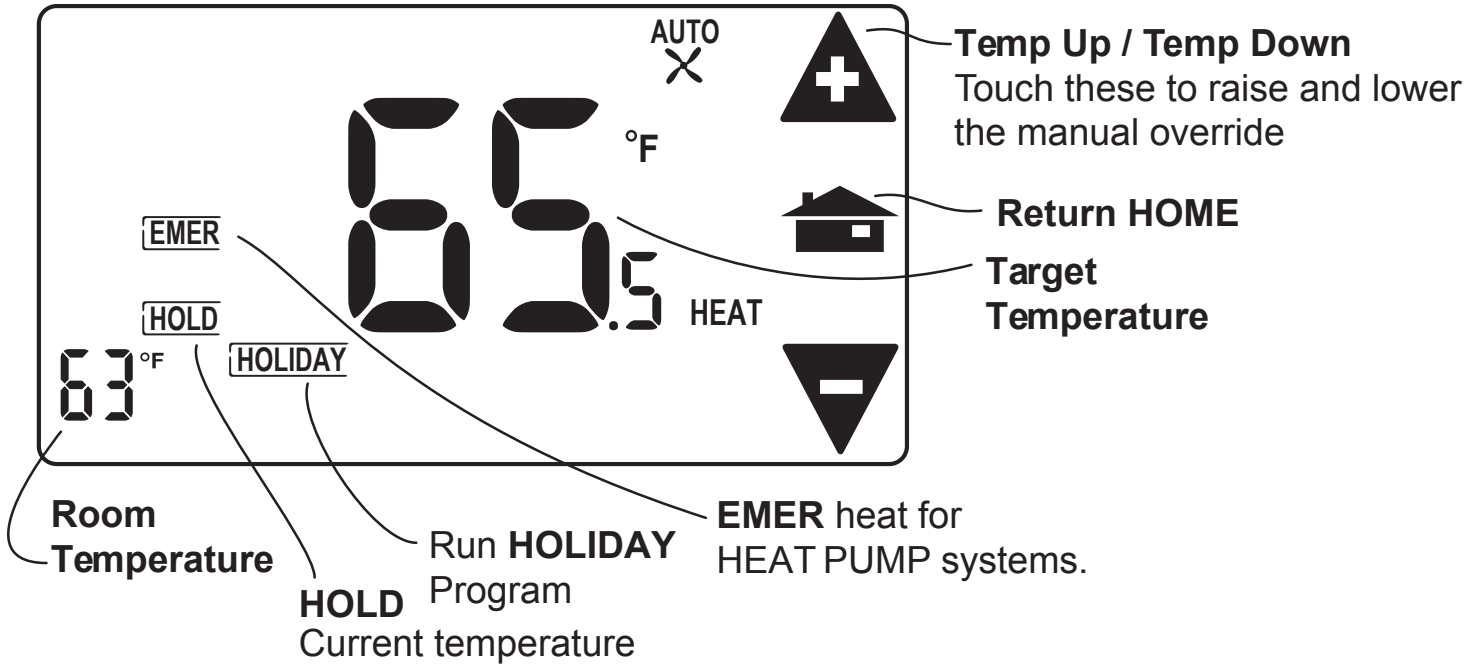

Initial Settings

Press **MENU** to access the following commands (from HOME screen).

Set time of day

Touch the Time of Day arrows to move the time selection forward or backward until it displays the current time. Touch and hold for faster setting.



Set °F-°C display

Touch the °F and it will toggle to °C.



Set audible chirp

Touch the musical note icon to select the chirp or no chirp.

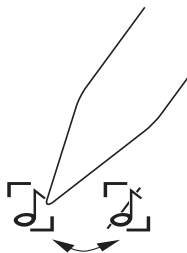

Return **HOME** by touching the home icon.

Run pre-set Program

The CT32 comes pre-programmed with an EPA approved program. This program is recommended by the EPA for energy efficiency. We strongly recommend that you run this program for one week, and see if it works for you. If it does not fit your needs you can always input a custom program.

To run the EPA program, set the mode switch to HEAT or COOL.

Touch the DAY area and advance it to select the present day.

Touch HOME. The unit is now running the program.

EPA	MORN	DAY	EVEN	NIGHT		MORN	DAY	EVEN	NIGHT
HEAT	6:00am	8:00am	6:00pm	10:00pm	COOL	6:00am	8:00am	6:00pm	10:00pm
All Days	70°F	62°F	70°	62°F	All Days	78°F	85°F	78°F	82°F

TO CHANGE THE PROGRAM:

Make sure the CT32 mode is set to either HEAT or COOL, touch **MENU** then touch **PROGRAM**.

This puts you at the **PROGRAM** screen [see page 4]. The programmed start time is displayed in the upper left. The TIME SLOT icon indicates the active TIME SLOT in the default program [MORN, DAY, EVEN, NIGHT]. The programmed Target Temperature is shown on main display.

The HEAT program and the COOL program are separate.

PROGRAM cont.

Select the **day** you want to program.

The day of the week starts at SU - Sunday and can be advanced to the day you want to program.

Touch the day of the week area to cycle through the days of the week to the desired day. The HOLIDAY is at the 8th day position and has two time slots.

Select the **time slot** (period) you want to program (MORN, DAY, EVEN, NIGHT).

Touch the time slot area to cycle through to the desired period.

Select the desired **start time** of that time slot.

Touch the time arrows to select the desired period's starting time. Hold arrow down for fast time scrolling.

Select the desired **target temperature** for that time slot.

Touch the +/- arrows to select the desired period's temperature.

To **COPY** one day's programming to the next day, touch COPY DAY once. The information for the current day will be copied to the next day which will appear on the screen. Holding down COPY for over 3 seconds will copy to all 7 days.

Touch  to return to the Home screen.

MENU Screen Functions

Press MENU to bring up MENU screen.

TIME of DAY

Touch the left (down) or right (up) arrows next to the time display to set the current time (1 minute per touch). Touch and hold the arrow for fast time set (15 minute jumps).

SWING (HVAC cycling rate) This feature allows you to set the desired variance in temperature between the CT32 setting and the room temperature required before the heating or cooling system will turn on—Swing range: 0.5 to 4.0°F (.25 to 2°C). For example, if SWING is set to 2.0°F and the CT32 is set to 70°F Target Temperature, the heat cycle will start when room temperature drops to 68°F. Similarly, the cooling system will start when the room temperature increases to 72°F. The HVAC then runs and will shut off at the Target Temperature.

To set **SWING**:

Touch SWING.

Touch the left/right arrows to set the SWING from 0.5° to 4.0°F (.5 to 2°C).

The HVAC will run more frequently at .5°F and less at 4°F. Default is 1°F.

Touch  to return to the MENU screen.



 **Chirp set** - Touch this to turn the audible chirp sound on or off.



Set - Touch this to switch the temperature display scale from °F to °C .

 **LOCK** (The CT32 has 2 lock modes)

Touch  icon for 5 seconds; the unit will go into the PARTIAL lock mode. The user can temporarily override the CT32 target by 2°F to 9°F with the +/- buttons only. (1 bar)

For FULL lock : Touch the  (1 bar) icon again for 5 seconds to go to full lock. No changes can be made in full lock  (2 bars). Once locked, the CT32 will respond just to **MENU**.

To UNLOCK , Press MENU.

Touch and hold  icon for 5 seconds for 2 bars (if not there already).

Then touch and hold the  icon for another 5 seconds. Each 5 second touch and hold must be separate.

Touch  to return to the Home screen.

FAST RECOVERY **ECON**

For multi-stage systems, recovery from a setback can be set for **FAST** (using multi stages for recovery to target temperature), or **ECON** (uses multi stages to the DIFF and then just the primary stage(s) to the target temperature).

CALIBRATE

Your thermostat was accurately calibrated at the factory to $\pm 1^\circ$ F of actual ambient temperature. You do have the option, however, to change the display temperature to match that of a previous thermostat, or to match another thermostat already in your home. The range of change is from -6° F to $+6^\circ$ F or -3° C to $+3^\circ$ C.

To change your Thermostat Calibration, touch **MENU** and then touch **CALIBRATE**.

Use the + / - to adjust the displayed temperature up or down, as desired.

The DELTA FACTOR that appears on the screen will also automatically increase or decrease for each 0.5° (F or C) adjustment so you can see your change. The large display will show the modified temperature reading that will be displayed on the HOME screen and used as the new room temperature.

Touch  to return to the Home screen.

DIFF (Used for multiple stage systems only, not on screen for single stage)

The differential is the number of degrees between the room temperature and the Target Temperature at which the 2nd stage will be used. Default is 2° F , range is 2° F to 6° F (1° - 3° C).

Touch MENU and then DIFF. Use the arrows to set the DIFF.

Recommend 2° F for very cold climates and the 4° F for warm climates and 6° F for hot climates.

MANUAL Screen Functions

The CT32 has 2 manual override commands. The manual screen is accessed by touching the large current temperature display in the middle of the HOME screen.

IMPORTANT: The Mode must be in HEAT or COOL to access the manual screen.

TEMPERATURE Touch the +/- arrows to select your desired Target Temperature. This temporary change in target will revert to the programmed target at the next time slot . Touch HOME to return to operation.

EMER (in HEAT PUMP type)

If you set your CT32 for HEAT PUMP with auxiliary heat, EMER function is available on the MANUAL screen. If you touch **EMER**, it displays **EMER|ON**. Your HEAT PUMP is disabled and auxiliary heat is your sole source of heat. This manual override stays active until you toggle EMER off. Auxiliary heat is more expensive than the heat pump so use EMER only if the heat pump cannot keep up or is defective.

To use EMER heat automatically - If DIFF is set to 2F and RECOVERY is set to FAST, the CT32 will use EMER heat automatically if the heat pump cannot keep up.

Other Functions

MODE Button - The mode button sets the CT32 to HEAT, COOL, AUTO, or OFF modes. Press it once to step through OFF to the next mode: HEAT -> OFF-> COOL -> OFF -> AUTO, etc. If the CT32 is in OFF and you want to return to the mode you were previously in, touch the OFF indicator on upper left of the screen.

FAN Icon - The fan control is normally in AUTO mode, meaning that the fan operates automatically with the HVAC system and the thermostat. When the fan button is touched the fan goes ON; the fan will run continuously in this manual override until switched back to AUTO by touching the FAN icon again.

[NOTE: Fan **ON** function is available in the OFF mode to allow simple ventilating.]

RESET button - The RESET button re-boots the CT32 processor. It does not effect the target temperatures that have been stored in permanent memory. To reset the unit to factory default settings, go to OFF mode, touch the center of the screen for 6 seconds until 00 appears, then push reset.

Compressor Protection - The CT32 has a minimum cycle time of 4 minutes to protect your compressor in cool and in heat pump (if you have one). The Home screen will show a hour glass and "Please Wait..." during this time and the compressor will not come on until the 4 minute delay is over.

Simple HOME Screen - To make this the default HOME screen for your CT32:

1. Switch the MODE to OFF.
2. Press MENU.
3. Touch and hold the PROGRAM icon for 15 seconds.

This Simple home screen gives you limited access to the CT32's on screen display and no programming capability. It makes the CT32 behave like a simple one setting thermostat. When in SIMPLE SCREEN, the time, day of the week and program are no longer displayed or available.

The simple screen is useful for people who do not want a complex schedule changing their target temperatures each day.

To return to the HOME screen:

1. Go to OFF MODE.
2. Press MENU.
3. Touch and hold the PROGRAM icon for 15 seconds.

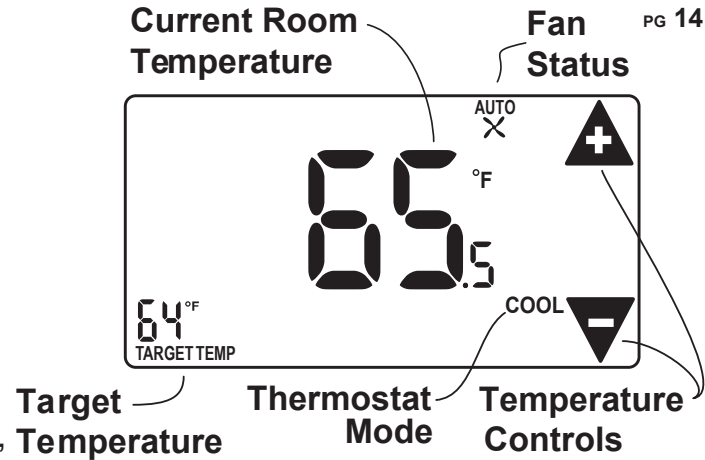

Communicating Thermostat

The CT32 has two USNAP slots to accommodate home automation radios from various systems. Please refer to radio documentation for network for specific installation instructions. The USNAP ports allow you to connect your CT32 to a wireless network. This can give you access to your home's HVAC system even when you are away. It can also give you access to web-based efficient energy management sites that can help you save money and protect the environment.

To Insert a USNAP radio module:

Caution: DO NOT INSERT or REMOVE USNAP radio modules if power is ON. This can damage the thermostat or radio modules. Only one USNAP radio can be used at a time.

1. Power off the CT32.
2. Remove the slot cover and insert radio module in either slot on the back of the CT32. Take care to ensure that the radio mates well with the connection pins on the thermostat.
3. Power up CT32.

TO CONNECT to a network follow the instructions that came with the USNAP module.

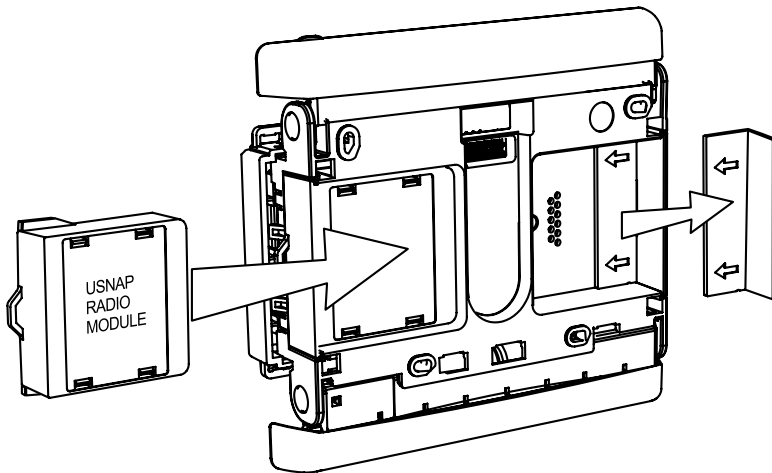

Before you set-up your Wi-Fi Thermostat to connect to the Internet, you will need access to these items:

1. Your favorite Wi-Fi device (iOS device or PC with Wi-Fi connected to the Internet) that is connected to your Wi-Fi network.
2. Your e-mail account to receive verification message.
3. Wi-Fi Thermostat powered from the C-Wire (Wi-Fi connection will not work on batteries-only powering the thermostat. You must have a C-Wire or other 24 VAC power source connected to your thermostat to operate the Wi-Fi radio).

When you have all of these close to the thermostat, please use your browser to go to ...

<http://www.radiothermostat.com/remote/>

You will be given interactive step-by-step instructions on how to connect your Wi-Fi Thermostat to the Internet cloud server. You can do this from a Wi-Fi connected PC or iOS device (Mac or iPhone or iPad). The iOS device usually provides the easiest path for connection to the cloud, but a PC will work fine.

When you go to our website you will be asked to register and create an account on the cloud server for all your thermostats. Once you have this account you can connect as many thermostats as you like to it and organize them by street address.

To verify that you are you, an e-mail will be sent to you that you must respond to. It will have further instructions and a link to complete your registration. You need to verify you are ready to connect to

Wi-Fi. Once we are sure you have the thermostat connected to the HVAC in your location, you will be prompted to download the Wireless Setup Guide for your system (PC or iOS). This guide gives you specific step-by-step instructions to make the connection.

For Android phone users, there is an Android app to control your thermostat. You will need to use another device (PC or iOS) to connect and provision your thermostat. Then the Android app will be able log in to your cloud server account and control your thermostat.

SAFE Screen - When you see this screen the CT32 is in SAFE Screen. This means that the CT32 is undergoing a firmware update. The CT32 is able to accept updated firmware from time to time as supplied by the cloud server. You can initiate an update when they are made available by your cloud service provider. These updates usually take 4-5 minutes to complete.

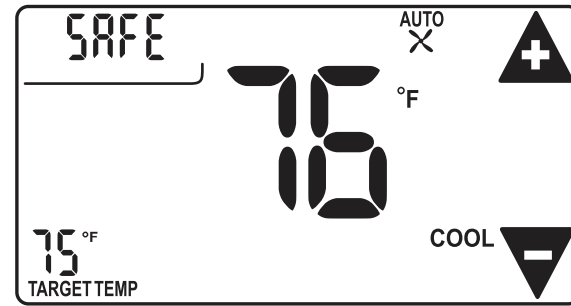

When in SAFE screen the CT32 provides basic thermostatic control for one stage of HEAT and one stage of COOL. [If you have a Heat Pump only AUX HEAT will be available.] It will use default Target Temperatures of Heat 62°F - Cool 82°F. You can adjust Target Temperatures up or down when in SAFE screen. The MODE can be set to HEAT, OFF, or COOL.

After upgrade completes the thermostat will resume full functions as before. Updates are only available using a WiFi radios. Should the update fail the thermostat will remain in SAFE screen and retry three times. If this process fails please contact the cloud service provider for options.