

**NOKIA**

# Nokia 9 PureView User Guide



# About this user guide



**Important:** For important information on the safe use of your device and battery, read “For your safety” and “Product Safety” info in the printed user guide, or at [www.nokia.com/support](http://www.nokia.com/support) before you take the device into use. To find out how to get started with your new device, read the printed user guide.

# Table of Contents

<b>About this user guide</b>	<b>2</b>
<b>Get started</b>	<b>6</b>
Keep your phone up to date	6
Keys and parts	6
Insert or remove the SIM card	8
Charge your phone	8
Switch on and set up your phone	9
Dual SIM settings	10
Setting up fingerprint ID	11
Lock or unlock your phone	11
Use the touch screen	12
<b>Basics</b>	<b>16</b>
Personalize your phone	16
Open and close an app	16
Notifications	17
Control volume	18
Screenshots	19
Battery life	19
Save on data roaming costs	20
Write text	21
Date and time	24
Clock and alarm	24
Calculator	26
Accessibility	26
<b>Connect with your friends and family</b>	<b>28</b>
Calls	28
Contacts	28
Send and receive messages	29
Mail	30
Get social	31
<b>Camera</b>	<b>33</b>

Camera basics	33
Record a video	34
Use your camera like a pro	36
Your photos and videos	37
<b>Internet and connections</b>	<b>40</b>
Activate Wi-Fi	40
Use a mobile data connection	40
Browse the web	41
Close a connection	43
Bluetooth®	44
NFC	46
VPN	47
<b>Organize your day</b>	<b>49</b>
Calendar	49
Notes	49
<b>Maps</b>	<b>51</b>
Find places and get directions	51
Download and update maps	51
Use location services	52
<b>Apps and services</b>	<b>54</b>
Google Play	54
<b>Software updates and backups</b>	<b>56</b>
Update your phone software	56
Back up your data	56
Restore original settings and remove private content from your phone	57
Storage	57
<b>Protect your phone</b>	<b>59</b>
Protect your phone with your fingerprint	59
Change your SIM PIN code	59
Access codes	60
<b>Product and safety information</b>	<b>63</b>
For your safety	63
Network services and costs	66
Emergency calls	67
Take care of your device	67

Recycle	<b>68</b>
Crossed-out wheelie bin symbol	<b>68</b>
Battery and charger information	<b>69</b>
Small children	<b>70</b>
Medical devices	<b>71</b>
Implanted medical devices	<b>71</b>
Hearing	<b>71</b>
Protect your device from harmful content	<b>72</b>
Vehicles	<b>72</b>
Potentially explosive environments	<b>72</b>
Wet or dusty conditions	<b>73</b>
Certification information (SAR)	<b>73</b>
About Digital Rights Management	<b>75</b>
Copyrights and notices	<b>75</b>

# Get started

## Keep your phone up to date

### YOUR PHONE SOFTWARE

Keep your phone up to date and accept available software updates to get new and enhanced features for your phone. Updating the software may also improve your phone's performance.

## Keys and parts

Explore the keys and parts of your new phone.

### YOUR PHONE

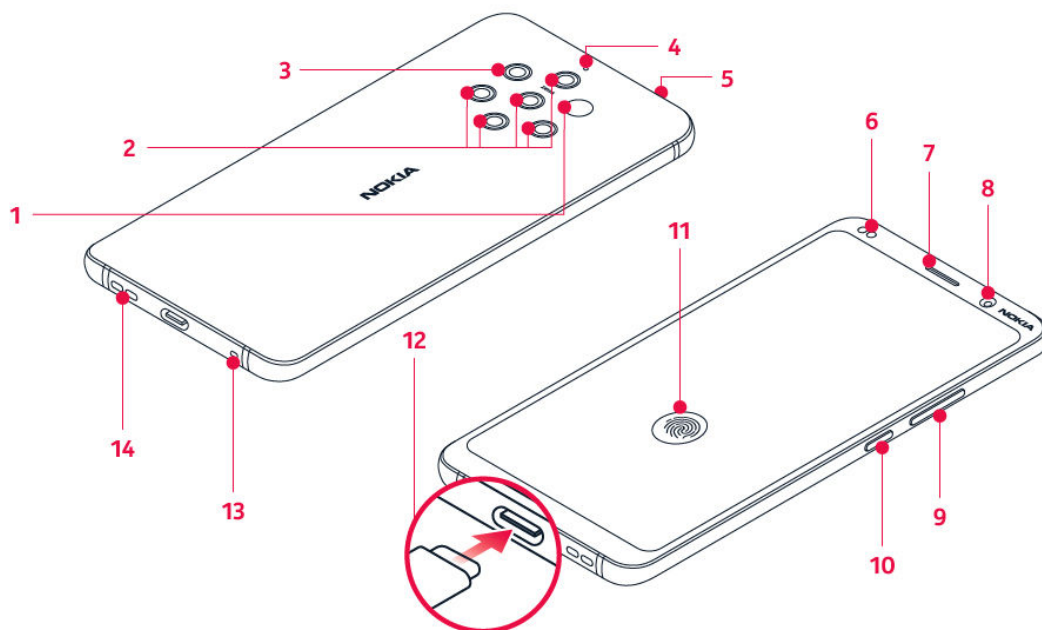

This user guide applies to following models: TA-1087 and TA-1082.

1. Infrared sensor
2. Camera
3. Flash
4. Microphone
5. SIM card slot
6. Proximity sensor
7. Earpiece
8. Front camera
9. Volume keys
10. Power/Lock key
11. Fingerprint sensor. The fingerprint sensor is located on the phone display. Press your finger on  to unlock the phone.
12. Charger and headset connector (USB Type-C audio output)<sup>1</sup>
13. Microphone
14. Loudspeaker

Some of the accessories mentioned in this user guide, such as charger, headset, or data cable, may be sold separately.



**Important:** The device screen and back cover is made of glass. This glass can break if the device is dropped on a hard surface or receives a substantial impact. If the glass breaks, do not touch the glass parts of the device or attempt to remove the broken glass from the device. Stop using the device until the glass is replaced by authorized service personnel.

## USE THE HEADSET ADAPTER

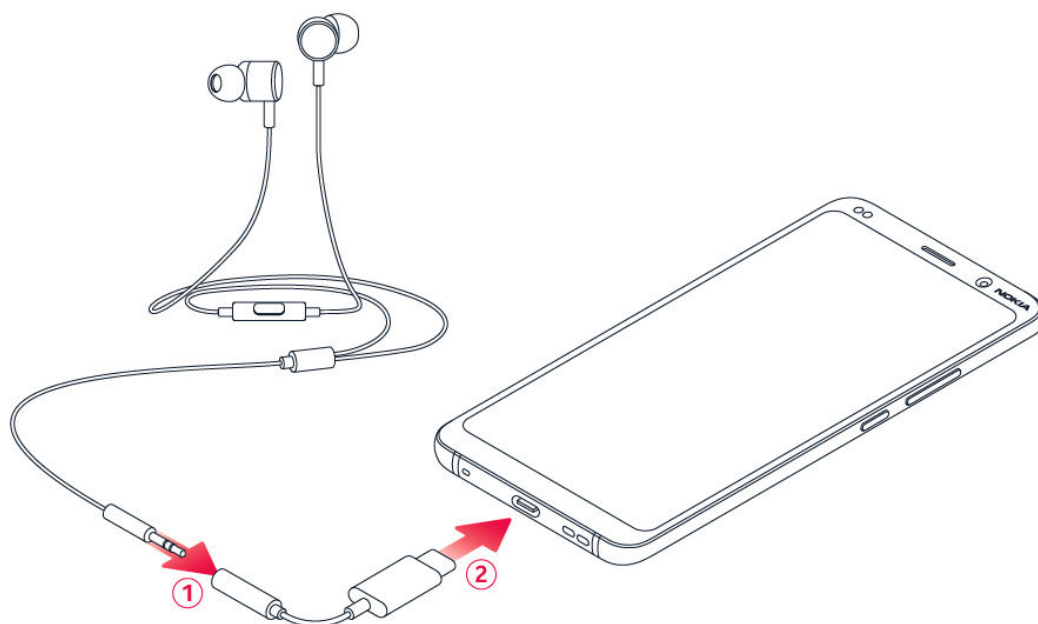

Your phone has a USB Type-C audio output. You can use a regular 3.5mm plug headset with your new phone: just plug the headset in the adapter that came with your phone, and then plug the USB end of the adapter in your phone.

## PARTS AND CONNECTORS, MAGNETISM

Do not connect to products that create an output signal, as this may damage the device. Do not connect any voltage source to the audio connector. If you connect an external device or headset, other than those approved for use with this device, to the audio connector, pay special attention to volume levels.

Parts of the device are magnetic. Metallic materials may be attracted to the device. Do not place credit cards or other magnetic stripe cards near the device for extended periods of time, since the cards may be damaged.

<sup>1</sup>

Your phone supports only digital audio output.

## Insert or remove the SIM card

### INSERT THE SIM CARD

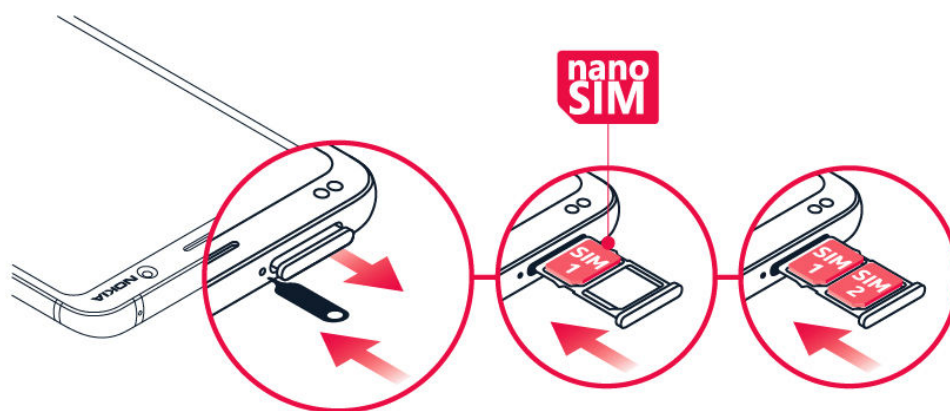

1. Open the SIM card tray: push the tray opener pin in the tray hole and slide the tray out.
2. Put a nano-SIM card on the tray with the contact area face down. If you have a dual-SIM phone, put the second SIM card in slot 2 with the contact area face down.
3. Slide the tray back in the slot. <sup>1</sup>

<sup>1</sup>

Use only original nano-SIM cards. Use of incompatible SIM cards may damage the card or the device, and may corrupt data stored on the card.



## Charge your phone

### CHARGE THE BATTERY



1. Plug a compatible charger into a wall outlet.
2. Connect the cable to your phone.

You can charge your phone using wireless charging. Use only Qi compatible chargers for wireless charging.

Your phone supports the USB-C cable. You can also charge your phone from a computer with a USB cable, but it may take a longer time.

If the battery is completely discharged, it may take several minutes before the charging indicator is displayed.

## Switch on and set up your phone

When you switch your phone on for the first time, your phone guides you to set up your network connections and phone settings.

### SWITCH ON YOUR PHONE

1. To switch on your phone, press and hold the power key until the phone vibrates.
2. When the phone is switched on, choose your language and region.
3. Follow the instructions shown on your phone.

## TRANSFER DATA FROM YOUR PREVIOUS PHONE

You can transfer data from an old phone to your new phone using your Google account.

To back up data on your old phone to your Google account, refer to your old phone's user guide.

1. Tap **Settings** > **Accounts** > **Add account** > **Google** .
2. Select which data you want to restore on your new phone. The sync starts automatically once your phone is connected to the internet.

## RESTORE APP SETTINGS FROM YOUR PREVIOUS ANDROID PHONE

If your previous phone was an Android, and back up to Google account is enabled on it, you can restore your app settings and Wi-Fi passwords.

1. Tap **Settings** > **System** > **Advanced** > **Backup** .
2. Switch **Backup to Google Drive** to **On** .

## Dual SIM settings

If you have a dual SIM variant, you can have 2 SIMs in your phone, for example, one for your work and one for your personal use.

## CHOOSE WHICH SIM TO USE

When, for example, making a call, you can choose which SIM to use by tapping the corresponding SIM 1 or SIM 2 button after you dial the number.

Your phone shows the network status for both SIMs separately. Both SIM cards are available at the same time when the device is not being used, but while one SIM card is active, when, for example, making a call, the other may be unavailable.

## MANAGE YOUR SIMS

Don't want work to interfere with your free time? Or do you have a cheaper data connection on one SIM? You can decide which SIM you want to use.

Tap **Settings** > **Network & Internet** > **SIM Cards** .

## RENAME A SIM CARD

Tap the SIM you want to rename, and type in the name you want.

## SELECT WHICH SIM TO USE FOR CALLS OR DATA CONNECTION

Under **Preferred SIM for** , tap the setting you want to change and select the SIM.

## Setting up fingerprint ID

You can unlock your phone with just a touch of your finger. Set up your fingerprint ID for extra security.

## ADD A FINGERPRINT

1. Tap **Settings** > **Security & Location** > **Fingerprint** . If you don't have screen lock set up on your phone, tap **Set up screen lock** .
2. Select what backup unlocking method you want to use for the lock screen and follow the instructions shown on your phone.

## Lock or unlock your phone

### LOCK YOUR PHONE

If you want to avoid accidentally making a call when your phone is in your pocket or bag, you can lock your keys and screen.

To lock your keys and screen, press the power key.

### UNLOCK THE KEYS AND SCREEN

Press the power key, and swipe up across the screen. If asked, provide additional credentials.

## Use the touch screen

**Important:** Avoid scratching the touch screen. Never use an actual pen, pencil, or other sharp object on the touch screen.

### YOUR PHONE DISPLAY

Leaving the phone screen on with maximum brightness level for a long time may cause the display image to remain on the screen even when the screen switches off or when a new image appears on the screen.

To avoid this:

- Lock your screen when you're not using the phone and set the phone screen to switch off after a short time. Tap **Settings** > **Display** > **Advanced** > **Sleep** and select the time.
- Keep your phone up to date and accept available software updates
- Lower the screen brightness: tap **Settings** > **Display** > **Brightness level** . To adjust the brightness, drag the brightness level slider. Make sure that **Adaptive brightness** is disabled.

## TAP AND HOLD TO DRAG AN ITEM

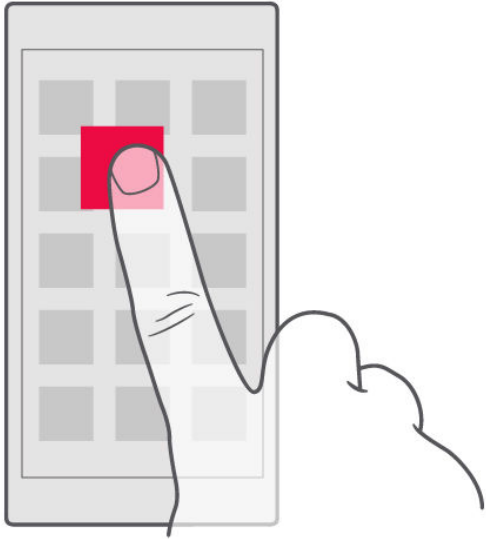

Place your finger on the item for a couple of seconds, and slide your finger across the screen.

## SWIPE

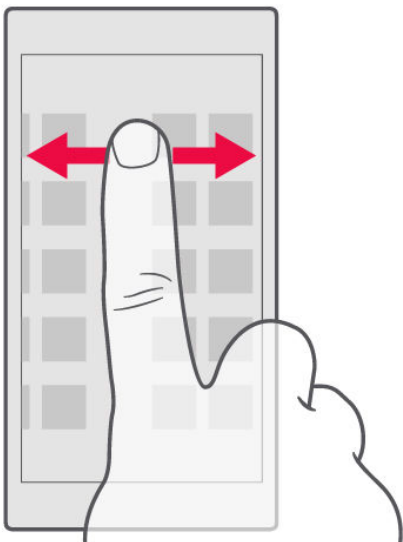

Place your finger on the screen, and slide your finger in the direction you want.

## SCROLL THROUGH A LONG LIST OR MENU

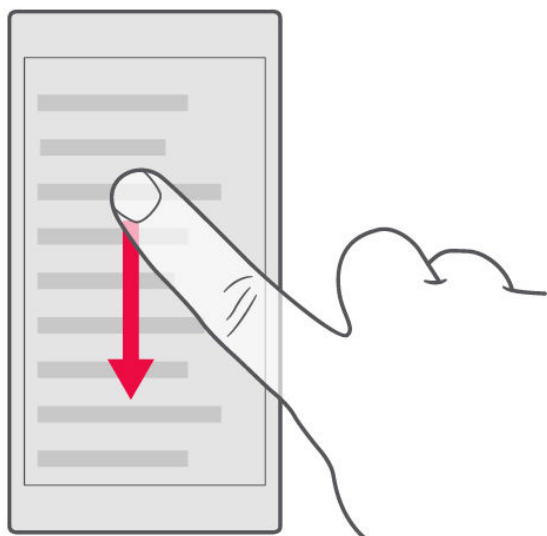

Slide your finger quickly in a flicking motion up or down the screen, and lift your finger. To stop the scrolling, tap the screen.

## ZOOM IN OR OUT

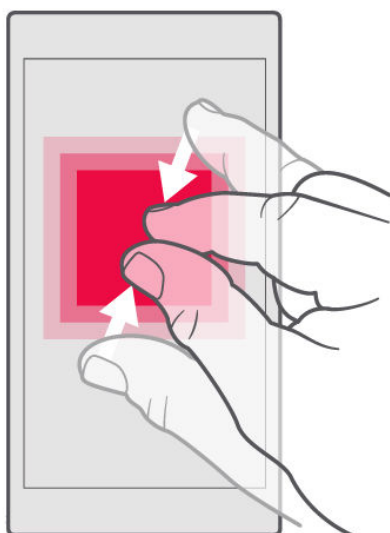

Place 2 fingers on an item, such as a map, photo, or web page, and slide your fingers apart or together.

## LOCK THE SCREEN ORIENTATION

The screen rotates automatically when you turn the phone 90 degrees.

To lock the screen in portrait mode, swipe down from the top of the screen, and tap **Auto-rotate** to switch to **Portrait**.

## USE THE NAVIGATION KEYS

To see which apps you have open, swipe up the home key .

To switch to another app, swipe right.

To close an app, swipe it up.



To go back to the previous screen you were in, tap the back key . Your phone remembers all the apps and websites you've visited since the last time your screen was locked.

To go to the home screen, tap the home key . The app you were in stays open in the background.



Do you want the overview key  back? Tap **Settings** > **System** > **Gestures**. Disable **Swipe up on Home button** and you have the overview key back on the bottom right of your screen.

## OPEN TWO APPS AT ONCE

1. To navigate easier between apps, swipe up the home key .
2. Tap the app icon on top of the app and tap the  icon.
3. Tap another app in the app list to divide the screen between two apps.

To go back to the normal view, tap an app and swipe up.

# Basics

## Personalize your phone

Learn how to personalize the home screen and how to change ringtones.

### **CHANGE YOUR WALLPAPER**

Tap **Settings** > **Display** > **Wallpaper**.

### **CHANGE YOUR PHONE RINGTONE**

1. Tap **Settings** > **Sound**.
2. Tap **Phone ringtone (SIM1)** or > **Phone ringtone (SIM2)** to select the ringtone for respective SIMs.

### **CHANGE YOUR MESSAGE NOTIFICATION SOUND**

Tap **Settings** > **Sound** > **Advanced** > **Default notification sound**.

## Open and close an app

### **OPEN AN APP**

On the home screen, tap an app icon to open it. To open one of the apps running in the background, swipe up the home key  then swipe right and select the app.



## CLOSE AN APP

Swipe up the home key  and swipe up the app you want to close.

## FIND YOUR APPS

Swipe up the home key  and swipe up again to see all your apps.

## CLOSE ALL RUNNING APPS

Swipe up the home key , swipe right through all apps, and tap **CLEAR ALL**.

## Notifications

Stay in touch with what's happening on your phone with notifications.

### USE THE NOTIFICATION PANEL

When you receive new notifications, such as messages or missed calls, indicator icons appear on the status bar at the top of the screen. To see more information about the notifications, drag the status bar down. To close the view, swipe up on the screen.

To open the notification panel, drag the status bar down. To close the notification panel, swipe up on the screen.

To change the notification settings of an app, tap **Settings** > **Apps & notifications** and tap the app name to open the app settings. Tap **Notifications**. You can turn off or on the notifications per each app individually.



**Tip:** To see notification dots, tap **Settings** > **Apps & notifications** > **Notifications** and switch **Allow notification dots** to on. A small dot will appear on the app icon, if you've got a

notification, but haven't attended to it yet. Tap and hold the icon to see available options. You can tap the notification to open it, or swipe to dismiss.

## USE THE QUICK SETTING ICONS

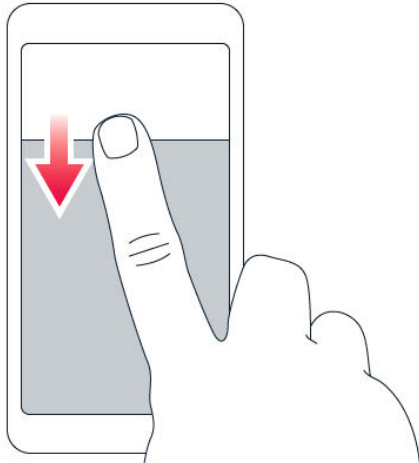

To activate features, tap the quick settings icons on the notification panel. To see more icons, drag the menu down.

To rearrange the icons, tap , tap and hold an icon, and then drag it to another location.

## Control volume

### CHANGE THE VOLUME



If you have trouble hearing your phone ringing in noisy environments, or calls are too loud, you can change the volume to your liking by using the volume keys on the side of your phone.

Do not connect to products that create an output signal, as this may damage the device. Do not connect any voltage source to the audio connector. If you connect an external device or headset, other than those approved for use with this device, to the audio connector, pay special attention to volume levels.

## CHANGE THE VOLUME FOR MEDIA AND APPS

Press a volume key on the side of your phone to see the volume status bar, tap , and drag the slider on the volume bar for media and apps left or right.

## SET THE PHONE TO SILENT

To set the phone to silent, press the volume down key, tap  to set your phone to vibrate only and tap  to set it to silent.



**Tip:** Don't want to keep your phone in silent mode, but can't answer right now? To silence an incoming call, press the volume down key. You can also set your phone to mute the ringing when you pick the phone up: tap [Settings](#) > [System](#) > [Gestures](#) > [Mute on pickup](#), and switch to on.

If you want to be able to reject an incoming call by turning over the phone, tap [Settings](#) > [System](#) > [Gestures](#) > [Turn over to reject call](#), and switch to on.

## Screenshots

### TAKE A SCREENSHOT

To take a screenshot, open the notification panel, and drag the status bar downwards. Tap [Screen capture](#). You can view captured images in [Photos](#).

It is not possible to capture a screenshot while using some apps and features.

## Battery life

Get the most out of your phone while getting the battery life you need. There are steps you can take to save power on your phone.

## EXTEND BATTERY LIFE

To save power:

1. Always charge the battery fully.
2. Mute unnecessary sounds, such as touch sounds. Tap **Settings > Sound > Advanced**, and under **Other sounds and vibrations**, select which sounds to keep.
3. Use wired headphones, rather than the loudspeaker.
4. Set the phone screen to switch off after a short time. Tap **Settings > Display > Advanced > Sleep** and select the time.
5. Tap **Settings > Display > Brightness level**. To adjust the brightness, drag the brightness level slider. Make sure that **Adaptive brightness** is disabled.
6. Stop apps from running in the background: swipe up the home key  and swipe up the app you want to close.
7. Enable **Battery Manager**. Limit battery for apps that you don't use often. The notifications may be delayed for these apps. Tap **Settings > Battery > Battery Manager**.
8. Switch on the power saver: tap **Settings > Battery > Battery saver**, and switch to **On**.
9. Use location services selectively: switch location services off when you don't need them. Tap **Settings > Security & Location > Location**, and disable **Use location**.
10. Use network connections selectively:
  - switch Bluetooth on only when needed.
  - Use a Wi-Fi connection to connect to the internet, rather than a mobile data connection.
  - Stop your phone scanning for available wireless networks. Tap **Settings > Network & Internet > Wi-Fi**, and disable **Wi-Fi**.
  - If you're listening to music or otherwise using your phone, but don't want to make or receive calls, switch the airplane mode on. Tap **Settings > Network & Internet > Advanced > Airplane mode**.

Airplane mode closes connections to the mobile network and switches your device's wireless features off.

## Save on data roaming costs

You can cut data roaming costs and save on your phone bills by changing mobile data settings. To use the optimal connection method, change the Wi-Fi and mobile networks settings.

Data roaming means using your phone to receive data over networks that your network service provider doesn't own or operate. Connecting to the internet when roaming, especially when abroad, can increase data costs substantially.

Using a Wi-Fi connection is generally faster and less expensive than using a mobile data connection. If both Wi-Fi and mobile data connections are available, your phone uses the Wi-Fi connection.

### CONNECT TO A WI-FI NETWORK

1. Tap **Settings** > **Network & Internet** > **Wi-Fi**.
2. Make sure Wi-Fi networking is turned on.
3. Select the connection you want to use.

### CLOSE THE MOBILE DATA CONNECTION

Swipe down from the top of the screen, tap **Mobile data** and switch **Mobile data** off.



**Tip:** To follow your data usage, tap **Settings** > **Network & Internet** > **Data usage**.

### STOP DATA ROAMING

Tap **Settings** > **Network & Internet** > **Mobile network**, and switch **Roaming** off.

## Write text

Learn how to write text quickly and efficiently using your phone's keyboard.

### **USE THE ON-SCREEN KEYBOARD**

Writing with the on-screen keyboard is easy. You can use the keyboard when holding your phone in portrait or landscape mode. The keyboard layout can vary in different apps and languages.

To open the on-screen keyboard, tap a text box.

### **SWITCH BETWEEN UPPER AND LOWER CASE CHARACTERS**

Tap the shift key. To switch caps lock mode on, double-tap the key. To return to normal mode, tap the shift key again.

### **TYPE IN A NUMBER OR SPECIAL CHARACTER**

Tap the numbers and symbols key. Some special character keys bring up more symbols. To see more symbols, tap and hold a symbol or special character.

### **INSERT EMOJIS**

Tap the emoji key, and select the emoji.

### **COPY OR PASTE TEXT**

Tap and hold a word, drag the markers before and after the word to highlight the section you want to copy, and tap **COPY**. To paste the text, tap where you want to paste the text and select **PASTE**.

## ADD AN ACCENT TO A CHARACTER

Tap and hold the character, and tap the accent or the accented character, if supported by your keyboard.

## DELETE A CHARACTER

Tap the backspace key.

## MOVE THE CURSOR

To edit a word you just wrote, tap the word, and drag the cursor to the place you want.

## USE KEYBOARD WORD SUGGESTIONS

Your phone suggests words as you write, to help you write quickly and more accurately. Word suggestions may not be available in all languages.

When you start writing a word, your phone suggests possible words. When the word you want is shown in the suggestion bar, select the word. To see more suggestions, tap and hold the suggestion.



**Tip:** If the suggested word is marked in bold, your phone automatically uses it to replace the word you wrote. If the word is wrong, tap and hold it to see a few other suggestions.

If you do not want the keyboard to suggest words while typing, turn off the text corrections. Tap **Settings** > **System** > **Languages & input** > **Virtual keyboard**. Select the keyboard you normally use. Tap **Text correction** and switch off the text correction methods you do not want to use.

## **CORRECT A WORD**

If you notice that you have misspelled a word, tap it to see suggestions for correcting the word.

## **SWITCH SPELL CHECKER OFF**

Tap **Settings** > **System** > **Languages & input** > **Advanced** > **Spell checker**, and switch **Spell checker** to **Off**.

## Date and time

Keep track of time – learn how to use your phone as a clock, as well as an alarm clock, and how to keep your appointments, tasks, and schedules up to date.

## **SET DATE AND TIME**

Tap **Settings** > **System** > **Date & time**.

## **UPDATE THE TIME AND DATE AUTOMATICALLY**

You can set your phone to update the time, date, and time zone automatically. Automatic update is a network service and may not be available depending on your region or network service provider.

1. Tap **Settings** > **System** > **Date & time**.
2. Switch **Automatic date & time** on.
3. Switch **Automatic time zone** on.

## **CHANGE THE CLOCK TO THE 24-HOUR FORMAT**

Tap **Settings** > **System** > **Date & time**, and switch **Use 24-hour format** on.



## Clock and alarm

Your clock is not just for alarms – learn what else you can do.

### USE THE COUNTDOWN TIMER

No more overcooking – use the countdown timer to measure your cooking times.

1. Tap **Clock** >  **TIMER**.
2. Set the duration of the timer.



### USE THE STOPWATCH

Use the stopwatch to see how you improve on the running track.

Tap **Clock** >  **STOPWATCH**.

### SET AN ALARM

You can use your phone as an alarm clock.

1. Tap **Clock** >  **ALARM**.
2. To add an alarm, tap .
3. To modify an alarm, tap it. To set the alarm to repeat on specific dates, check **Repeat** and highlight the days of the week.

### SNOOZE AN ALARM

If you don't want to get up just yet, when the alarm sounds, swipe the alarm left. To adjust the snooze length, tap **Clock** >  > **Settings** > **Snooze length** and select the length to your liking.

## SWITCH AN ALARM OFF

When the alarm sounds, swipe the alarm right.

## DELETE AN ALARM

Tap **Clock** >  **ALARM**. Select the alarm, and tap  **Delete**.

## Calculator

Forget your pocket calculator – there’s a calculator in your phone.

## USE THE CALCULATOR

Tap **Calculator**.

To use the advanced calculator, swipe the bar from the right edge of the screen to the left.

## Accessibility

You can change various settings to make using your phone easier.

## INCREASE OR DECREASE THE FONT SIZE

Do you want to have larger fonts on your phone?

1. Tap **Settings** > **Accessibility**.
2. Tap **Font size**. To increase or decrease the font size, drag the font size level slider.

## **INCREASE OR DECREASE THE DISPLAY SIZE**



Do you want to make the items on your screen smaller or larger?

1. Tap **Settings** > **Accessibility** .
2. Tap **Display size** and to adjust the display size, drag the display size level slider.

# Connect with your friends and family

## Calls

### MAKE A CALL

1. Tap .
2. Type in a number, or tap  and select a contact you want to call.
3. Tap . If you have a second SIM inserted, tap the corresponding icon to make a call from a specific SIM.

### ANSWER A CALL

When the phone rings, swipe up to answer.



**Tip:** Don't want to keep your phone in silent mode, but can't answer right now? To silence an incoming call, press the volume down key. You can also set your phone to mute the ringing when you pick the phone up: tap [Settings](#) > [System](#) > [Gestures](#) > [Mute on pickup](#), and switch to on.

If you want to be able to reject an incoming call by turning over the phone, tap [Settings](#) > [System](#) > [Gestures](#) > [Turn over to reject call](#), and switch to on.

### REJECT A CALL

To reject a call, swipe down.

## Contacts

Save and organize your friends' and family members' phone numbers.

## SAVE A CONTACT FROM CALL HISTORY

1. In **Phone**, tap  to see call history.
2. Tap the number you want to save.
3. Select if you want to **Create new contact** or **Add to a contact**.
4. Type in the contact information, and tap **Save**.

## ADD A CONTACT

1. Tap **Contacts** > .
2. Fill out the information.
3. Tap **Save**.



## EDIT A CONTACT

1. Tap **Contacts** and tap the contact you want to edit.
2. Tap .
3. Edit the information.
4. Tap **Save**.

## SEARCH FOR A CONTACT

1. Tap **Contacts**.
2. Tap .

## FILTER YOUR CONTACTS LIST

Tap **Contacts** >  >  **Settings**, tap **Sort by** or **Name format** under the Contacts list.

## IMPORT OR EXPORT CONTACTS

Tap **Contacts** >  >  **Settings** > **Import/export**.

## Send and receive messages

Keep in touch with your friends and family members through text messages.

### SEND A MESSAGE

1. Tap **Messages**.
2. Tap **Start chat**.
3. To add a recipient, type their number in a recipients box. To add a contact, start typing their name and tap the contact.
4. To add more recipients, tap **Start group conversation**. After choosing all the recipients, tap **>**.
5. Write your message in the text box.
6. Tap **>**.



**Tip:** If you want to send a photo in a message, tap **Photos**, tap the photo you want to share, and tap **<**. Select **Messages**.

### READ A MESSAGE

1. Tap **Messages**.
2. Tap the message you want to read. You can also read a message from the notification panel. Slide down from the top of the screen and tap the message.

### REPLY TO A MESSAGE

1. Tap **Messages**.
2. Tap the message you want to reply to.
3. Write your reply in the text box below the message and tap **>**.

## Mail

You can use your phone to read and reply to mail when you're on the go.

## ADD A MAIL ACCOUNT



When you use the Gmail app for the first time, you are asked to set up your email account.

1. Tap **Gmail**.
2. You can select the address connected with your Google account or tap **Add an email address**.
3. After adding all the accounts, tap **TAKE ME TO GMAIL**.



## DELETE A MAIL ACCOUNT

1. Tap **Settings** > **Accounts**.
2. Tap the account you want to delete and tap **REMOVE ACCOUNT**.



## SEND MAIL

1. Tap **Gmail**.
2. Tap .
3. In the **To** box, type in an address, or tap  > **Add from Contacts**.
4. Type in the message subject and the mail.
5. Tap .

## READ AND REPLY TO MAIL

1. Tap **Gmail**.
2. Tap the message you want to read.
3. To reply the message, tap , or tap  > **Reply all**.

## DELETE MAIL

1. Tap **Gmail**.
2. Tap the message you want to delete and tap .
3. To delete multiple messages, tap the circle with the recipient's initial to select messages and tap .

## Get social

Want to connect and share stuff with the people in your life? With social apps, you can stay up to date with what's happening with your friends.

### **SOCIAL APPS**

To keep in touch with your friends and family, sign in to your instant messaging, sharing, and social networking services. Select the service you want to use from your Home screen. Social apps are available in the [Google Play Store](#). The available services may vary.



# Camera

## Camera basics

Why carry a separate camera if your phone has all you need for capturing memories? With your phone's camera, you can easily take photos or record videos.



### TAKE A PHOTO

Shoot sharp and vibrant photos – capture the best moments in your photo album.

1. Tap **Camera**.
2. Take aim and focus.
3. Tap .





### TAKE A SELFIE

Need that perfect selfie? Use the phone's front camera to take one.

1. Tap **Camera**.
2. Tap  to switch to the front camera.
3. Take aim and focus.
4. Tap .

### TAKE A BOTHIE

In addition to perfect selfie, you can take a split-screen photo with your phone's camera. Use both front and rear cameras simultaneously.

1. Tap **Camera** and tap .
2. Tap  **Dual** for a split-screen photo. Or, to take a picture-in-picture photo, tap .
3. Take aim and focus.
4. Tap .
5. To go back to the full screen mode, tap  **Single**.







**Tip:** When you take a picture-in-picture photo or record a picture-in-picture video, and want to move the smaller picture, tap and hold it and drag it to the place where you want.

## TAKE PANORAMAS

Tap **Camera** > **Panorama** and follow the instructions on your phone.



## MAKE YOUR PHOTOS COME TO LIFE

Do you want to see your photos become short videos?

1. Tap **Camera** > **Motion off**  > **Motion on** .
2. Take aim and focus.
3. Tap .
4. Select the photo you just took, you can see it in the bottom right corner.
5. Tap  to see your photo come to life.

## Record a video

### RECORD A VIDEO

1. Tap **Camera**.
2. To switch to the video recording mode, swipe to left.
3. Tap  to start recording.
4. To stop recording, tap .
5. To go back to camera mode, swipe to right.

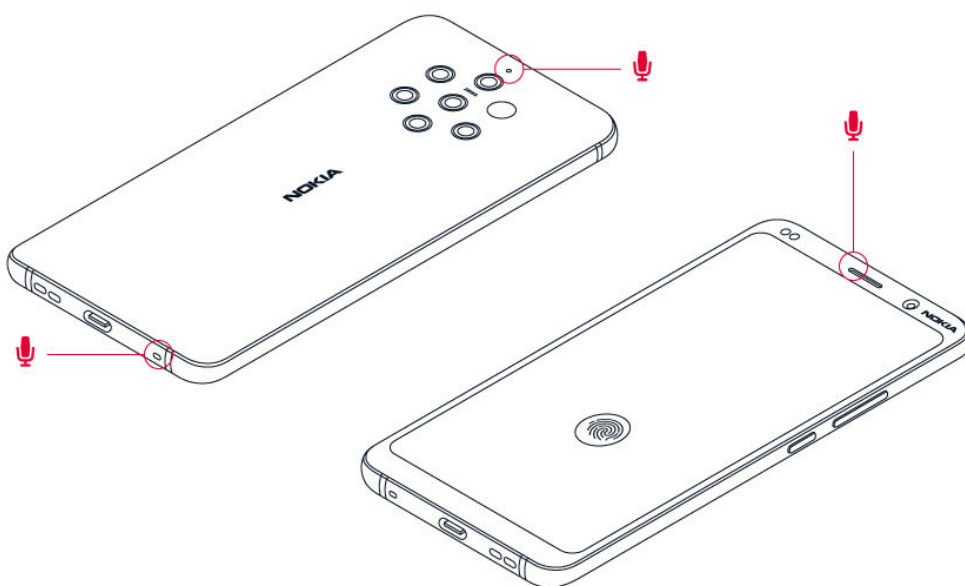

## USE THE FULL 360° SURROUND SYSTEM



With your phone camera, you can easily record videos with a full 360° surround sound.

Tap **Camera** . To switch to the video recording mode, swipe left.





Your phone has three microphones that use OZO Audio technology to record and process audio spatially. In the video recording mode, to change the way audio is recorded, tap .

1. To clearly record what is in front of you, while silencing audio coming from behind, tap  **Front** . Use this setting when you, for example, interview someone.
2. To clearly record your own voice or audio coming from behind you, while silencing audio coming in front, tap  **Rear** .
3. To record audio naturally from all directions, tap  **Surround** .



To optimize the audio quality for your videos, do not cover any of the small microphone holes of your phone while recording a video. To record a full 360° degrees surround sound, keep the phone in a horizontal position, and hold it by the sides.

## RECORD A BOTHIE VIDEO

You can record a split-screen video with your phone. Use both front and rear cameras simultaneously.



1. Tap **Camera**.
2. To switch to the video recording mode, swipe left. Tap .
3. Tap  **Dual** for a split-screen video. Or, to record a picture-in-picture video, tap  **P-I-P**.
4. Tap  to start recording.

## RECORD A SLOW MOTION VIDEO

1. To switch to the video recording mode, swipe left.
2. Tap **Slow Motion**.
3. Tap  to start recording.
4. To stop recording, tap .

## STREAM LIVE VIDEO

With your phone's camera, you can stream live video for social apps.

1. Tap **Camera**. To switch to the video recording mode, swipe left.
2. Tap  and select the social media account you want to use to do live broadcast.
3. Tap  to start live streaming.

## Use your camera like a pro



Use the different modes in you camera to enhance the quality of your photos.

## LEARN ABOUT YOUR CAMERA SETTINGS

In the Camera app, tap  to learn more about each setting.

## USE BOKEH MODE

If you want to be able to change the focus area of your photo after you have taken it, use Bokeh mode when taking a photo.





1. Tap **Camera** > **Bokeh** .
2. Take aim and focus, and tap .
3. Select the photo you just took, you can see it in the bottom right corner.
4. Tap  > **Bokeh Editor** to edit your photo.

## SET THE CAMERA TO PRO MODE

Tap **Camera** > **Pro** .



## ADD DEPTH AND PERSPECTIVE TO YOUR PHOTOS

Do you want to create a sense of depth and perspective in your photos?

1. Tap **Camera** > **Pro** .
2. Tap  > .
3. Take aim and focus, and tap .
4. Select the photo you just took, you can see it in the bottom right corner.
5. Tap  to edit your photo.

## TAKE PHOTOS WITH A TIMER

Want to have time to get in the shot too? Try out the timer.

1. Tap **Camera** .
2. Tap . The button shows the timer setting. To change it, tap it again.
3. Select the duration of the timer.
4. Tap .

## TAKE HIGH QUALITY PHOTOS

In Camera app, tap  > **Resolution** , and set the resolution that you want to.

## Your photos and videos

### VIEW PHOTOS AND VIDEOS ON YOUR PHONE

Want to relive those important moments? View photos and videos on your phone.

Tap **Photos**.

### PLAY A VIDEO

Tap **Photos** and tap the video you want to play.



**Tip:** To pause playback, tap **⏸**. To resume, tap **▶**.

### FAST FORWARD OR REWIND A VIDEO

To fast forward or rewind a video, drag the slider at the bottom of the screen right or left.

### COPY YOUR PHOTOS AND VIDEOS TO YOUR COMPUTER

Do you want to view your photos or videos on a larger screen? Move them to your computer.

You can use your computer's file manager to copy or move your photos and videos to the computer.

Connect your phone to the computer with a compatible USB cable. To set the USB connection type, open the notification panel, and tap the USB notification.

## SHARE YOUR PHOTOS AND VIDEOS

You can share your photos and videos quickly and easily for your friends and family to see.

1. In **Photos**, tap the photo you want to share and tap .
2. Select how you want to share the photo or video.

# Internet and connections

## Activate Wi-Fi

Using a Wi-Fi connection is generally faster and less expensive than using a mobile data connection. If both Wi-Fi and mobile data connections are available, your phone uses the Wi-Fi connection.

### TURN ON WI-FI

1. Tap **Settings** > **Network & Internet** > **Wi-Fi**.
2. Switch Wi-Fi to **On**.
3. Select the connection you want to use.

Your Wi-Fi connection is active when  is shown on the status bar at the top of the screen.

**Important:** Use encryption to increase the security of your Wi-Fi connection. Using encryption reduces the risk of others accessing your data.



**Tip:** If you want to track locations when satellite signals are not available, for example when you're indoors or between tall buildings, switch Wi-Fi on to improve positioning accuracy.

## Use a mobile data connection

### CLOSE THE MOBILE DATA CONNECTION

Swipe down from the top of the screen, tap **Mobile data** and switch **Mobile data** off.



## TURN ON THE MOBILE DATA CONNECTION

Swipe down from the top of the screen, tap **Mobile data** and switch **Mobile data** on.

## USE A MOBILE DATA CONNECTION WHEN ROAMING

Tap **Settings** > **Network & Internet** > **Mobile network**, and switch **Roaming** to **On**.<sup>1</sup>



**Tip:** To follow your data usage, tap **Settings** > **Network & Internet** > **Data usage**.

<sup>1</sup> Connecting to the internet when roaming, especially when abroad, can raise data costs substantially.

## Browse the web

### USE YOUR PHONE TO CONNECT YOUR COMPUTER TO THE WEB

It's simple to use the internet on your laptop on the go. Turn your phone into a Wi-Fi hotspot, and use your mobile data connection to access the internet with your laptop or other device.

1. Tap **Settings** > **Network & Internet** > **Hotspot & tethering**.
2. Switch on the **Wi-Fi hotspot** to share your mobile data connection over Wi-Fi, **USB tethering** to use a USB connection, or **Bluetooth tethering** to use Bluetooth.

The other device uses data from your data plan, which may result in data traffic costs. For info on availability and costs, contact your network service provider.

## START BROWSING

No need for a computer – you can easily browse the internet on your phone. Catch up on the news, and visit your favorite websites. You can use the browser on your phone to view web pages on the internet.

1. Tap **Chrome**.
2. Type a web address and tap →.



**Tip:** If your network service provider doesn't charge you a fixed fee for data transfer, to save on data costs, use a Wi-Fi network to connect to the internet.

## OPEN A NEW TAB

When you want to visit several websites at the same time, you can open new browser tabs and switch between them.

In Chrome,

1. Tap the box next to the address bar.
2. Tap **+**.

## SWITCH BETWEEN TABS

In Chrome,

1. Tap the box next to the address bar.
2. Tap the tab you want.

## CLOSE A TAB

In Chrome,

1. Tap the box next to the address bar.
2. Tap **X** on the tab you want to close.

## SEARCH THE WEB

Explore the web and the outside world with Google search. You can use the keyboard to write your search words.

In Chrome,

1. Tap the search bar.
2. Write your search word in the search box.
3. Tap →.

You can also select a search word from the proposed matches.

## USE YOUR DATA PLAN EFFICIENTLY

If you're worried about your data usage costs, your phone helps you prevent some apps from sending or receiving data when running in the background.

1. Tap **Settings** > **Network & Internet** > **Data usage** > **Data saver**.
2. Switch **Data saver** to **On**.

## Close a connection

### CLOSE INTERNET CONNECTIONS

Save your battery by closing internet connections that are open in the background. You can do it without closing any apps.

1. Tap **Settings** > **Network & Internet** > **Wi-Fi**.
2. Switch **Wi-Fi** to **Off**.

### CLOSE THE MOBILE DATA CONNECTION

Swipe down from the top of the screen, tap **Mobile data** and switch **Mobile data** off.

## TURN ON AIRPLANE MODE

1. Tap **Settings** > **Network & Internet** > **Advanced** .
2. Switch on **Airplane mode** .

Airplane mode closes connections to the mobile network and switches your device's wireless features off. Comply with the instructions and safety requirements given by, for example, an airline, and any applicable laws and regulations. Where allowed, you can connect to a Wi-Fi network to, for example, browse the internet or switch Bluetooth sharing on in airplane mode.

## Bluetooth®

You can connect wirelessly to other compatible devices, such as phones, computers, headsets, and car kits. You can also send your photos to compatible phones or to your computer.

## CONNECT TO A BLUETOOTH ACCESSORY

You can connect your phone with many useful Bluetooth devices. For example, with a wireless headset (sold separately), you can speak on the phone hands-free – you can continue what you're doing, such as working at your computer, during a call. Connecting a phone to a Bluetooth device is called pairing.

1. Tap **Settings** > **Connected devices** > **Connection preferences** > **Bluetooth** .
2. Switch **Bluetooth** to **On** .
3. Make sure the other device is switched on. You may need to start the pairing process from the other device. For details, see the user guide for the other device.
4. To pair your phone and the device, tap the device on the list of discovered Bluetooth devices.
5. You may need to type in a passcode. For details, see the user guide for the other device.

Since devices with Bluetooth wireless technology communicate using radio waves, they do not need to be in direct line-of-sight. Bluetooth devices must, however, be within 10 meters (33 feet) of each other, although the connection may be subject to interference from obstructions such as walls or from other electronic devices.

Paired devices can connect to your phone when Bluetooth is switched on. Other devices can detect your phone only if the Bluetooth settings view is open.

Do not pair with or accept connection requests from an unknown device. This helps to protect your phone from harmful content.

## REMOVE A PAIRING

If you no longer have the device with which you paired your phone, you can remove the pairing.

1. Tap **Settings** > **Connected devices** > **Previously connected devices** .
2. Tap  next to a device name.
3. Tap **FORGET** .

## CONNECT TO YOUR FRIEND'S PHONE WITH BLUETOOTH

You can use Bluetooth to wirelessly connect to your friend's phone, to share photos, and much more.

1. Tap **Settings** > **Connected devices** > **Connection preferences** > **Bluetooth** .
2. Make sure Bluetooth is switched on in both phones.
3. Make sure the phones are visible to each other. You need to be in the Bluetooth settings view for your phone to be visible to other phones.
4. You can see the Bluetooth phones within range. Tap the phone you want to connect to.
5. If the other phone needs a passcode, type in or accept the passcode, and tap **Pair** .

The passcode is only used when you connect to something for the first time.

## SEND YOUR CONTENT USING BLUETOOTH

When you want to share your content or send photos you've taken to a friend, use Bluetooth to send them to compatible devices.

You can use more than one Bluetooth connection at a time. For example, while using a Bluetooth headset, you can still send things to another device.

1. Tap **Settings** > **Connected devices** > **Connection preferences** > **Bluetooth** .

2. Switch **Bluetooth** to **On**.
3. Go to the content you want to send, and tap  > **Bluetooth**.
4. Tap the device to connect to. You can see the Bluetooth devices within range.
5. If the other device needs a passcode, type in the passcode. The passcode, which you can make up, must be typed in on both devices. The passcode in some devices is fixed. For details, see the user guide of the other device.

The location of the received files depends on the other device. For details, see the user guide for the other device.

## NFC

Explore the world around you. If your phone supports Near Field Communication (NFC), you can tap accessories to connect to them, and tap tags to call someone or open a website.

### GET STARTED WITH NFC

Switch on the NFC features in your phone, and start tapping to share stuff or connect to devices. To see if your phone supports NFC, tap **Settings** > **Connected devices** > **Connection Preferences**.

With NFC, you can:

- Connect to compatible Bluetooth accessories that support NFC, such as a headset or a wireless loudspeaker
- Tap tags to get more content for your phone, or to access online services
- Pay with your phone, if supported by your network service provider

The NFC area is on the back of your phone. Tap other phones, accessories, tags, or readers with the NFC area.

1. Tap **Settings** > **Connected devices** > **Connection preferences** > **NFC**.
2. Switch **NFC** to **On**.

Before using NFC, make sure the screen and keys are unlocked.

## READ NFC TAGS

NFC tags can contain info, such as a web address, a phone number, or a business card. The info you want is just a tap away.

To read a tag, tap the tag with the NFC area of your phone.



**Note:** Payment and ticketing apps and services are provided by third parties. HMD Global does not provide any warranty or take any responsibility for any such apps or services including support, functionality, transactions, or loss of any monetary value. You may need to reinstall and activate the cards you have added as well as the payment or ticketing app after repair of your device.

## CONNECT TO A BLUETOOTH ACCESSORY WITH NFC

Hands busy? Use a headset. Or why not listen to music using wireless speakers? You only need to tap the compatible accessory with your phone.

1. Tap the NFC area of the accessory with the NFC area of your phone.<sup>1</sup>
2. Follow the instructions on the screen.

## DISCONNECT THE CONNECTED ACCESSORY

If you don't need to be connected to the accessory anymore, you can disconnect the accessory.

Tap the NFC area of the accessory again.

For more info, see the accessory's user guide.

<sup>1</sup>

Accessories are sold separately. The availability of accessories varies by region.

## VPN

You may need a virtual private network (VPN) connection to access your company resources, such as intranet or corporate mail, or you may use a VPN service for personal purposes.

Contact your company IT administrator for details of your VPN configuration, or check your VPN service's website for additional info.

### USE A SECURE VPN CONNECTION

1. Tap **Settings** > **Network & Internet** > **Advanced** > **VPN**.
2. To add a VPN profile, tap **+**.
3. Type in the profile info as instructed by your company IT administrator or VPN service.

### EDIT A VPN PROFILE

1. Tap  next to a profile name.
2. Change the info as required.

### DELETE A VPN PROFILE

1. Tap  next to a profile name.
2. Tap **FORGET VPN**.



# Organize your day

## Calendar

Keep track of time – learn how to keep your appointments, tasks, and schedules up to date.

### MANAGE CALENDARS

Tap **Calendar** > , and select what type of calendar you want to see.

Calendars are added automatically when you add an account to your phone. To add a new account with a calendar, go to the apps menu and tap **Settings** > **Accounts** > **Add account**.

### ADD AN EVENT

To remember an appointment or an event, add it to your calendar.

1. In **Calendar**, tap **+** and select an entry type.
2. Type in the details you want, and set the time.
3. To make an event repeat on certain days, tap **More options** > **Does not repeat**, and select how often the event should repeat.
4. To edit the reminder time, tap the reminder time, and select the time you need.



**Tip:** To edit an event, tap the event and , and edit the details.

### DELETE AN APPOINTMENT

1. Tap the event
2. Tap  > **Delete**.

## Notes

### **MAKE A NOTE**

Notes on paper are easy to lose. Instead, jot them down with **Keep** app. This way, you always have your notes with you.

1. Tap **Keep** > **Take a note** .
2. Write a note.

Your notes are automatically saved.

# Maps

## Find places and get directions

### FIND A SPOT

Google Maps helps you find specific locations and businesses.

1. Tap **Maps**.
2. Write search words, such as a street address or place name, in the search bar.
3. Select an item from the list of proposed matches as you write, or tap  to search.

The location is shown on the map. If no search results are found, make sure the spelling of your search words is correct.

### SEE YOUR CURRENT LOCATION

Tap **Maps** > .

### GET DIRECTIONS TO A PLACE

Get directions for walking, driving, or using public transport – use your current location or any other place as the start point.

1. Tap **Maps** and enter your destination in the search bar.
2. Tap **Directions**. The highlighted icon shows the mode of transportation, for example . To change the mode, select the new mode under the search bar.
3. If you don't want the starting point to be your current location, tap **Your location**, and search for a new starting point.
4. Tap **START** to start the navigation.

The route is shown on the map, along with an estimate of how long it takes to get there. To see detailed directions, swipe up from the bottom of the screen.

## Download and update maps

### DOWNLOAD A MAP



Save new maps to your phone before a journey, so you can browse the maps without an internet connection when traveling.

1. Tap **Maps** >  > **Offline maps** > **SELECT YOUR OWN MAP** .
2. Select the area on the map and tap **DOWNLOAD** .

### UPDATE AN EXISTING MAP

1. Tap **Maps** >  > **Offline maps** and the map name.
2. Tap **UPDATE** .



**Tip:** You can also set your phone to update the maps automatically. Tap **Maps** >  > **Offline maps** >  and switch **Automatically update offline maps** and **Automatically download offline maps** to **On** .

### DELETE A MAP

1. Tap **Maps** >  > **Offline maps** and the map name.
2. Tap **DELETE** .

## Use location services

Use Maps to find out where you are, attach your location to the photos you take. Location info can be attached to a photo or video, if your location can be determined using satellite or network technology. If you share a photo or video that contains location info, the location info may be shown to those who view the photo or video. Some apps can use your location info to offer you a wider variety of services.

## SWITCH ON LOCATION SERVICES

Your phone shows your location on the map using a satellite positioning system, Wi-Fi, or network (Cell ID) based positioning.

The availability, accuracy and completeness of the location info depend on, for example, your location, surroundings, and third party sources, and may be limited. Location info may not be available, for example, inside buildings or underground. For privacy info related to positioning methods, see the HMD Global Privacy Policy, available at <http://www.nokia.com/phones/privacy>.

Some satellite positioning systems may require transferring small amounts of data over the mobile network. If you want to avoid data costs, for example when traveling, you can switch the mobile data connection off in your phone settings.

Wi-Fi positioning improves positioning accuracy when satellite signals are not available, especially when you are indoors or between tall buildings. If you're in a place where the use of Wi-Fi is restricted, you can switch Wi-Fi off in your phone settings.

Tap **Settings** > **Security & location**, and switch **Location** on.

# Apps and services

## Google Play

Your Android phone can live up to its full potential with Google Play – apps, music, movies and books are all readily available for your entertainment.

### **ADD A GOOGLE ACCOUNT TO YOUR PHONE**

1. Tap **Settings** > **Accounts** > **Add account** > **Google** . If asked, confirm your device lock method.
2. Type in your Google account credentials and tap **Next** , or, to create a new account, tap **Create account** .
3. Follow the instructions on your phone.

### **DOWNLOAD APPS**

Unleash your phone's potential – there are thousands of apps waiting in the Google Play Store to help you with this.<sup>1</sup>

1. Tap **Play Store** .
2. Tap the search bar to look for apps, or select apps from your recommendations.
3. In the app description, tap **INSTALL** to download and install the app.

To see your apps, go to the home screen and swipe up from the bottom of the screen.

### **UPDATE APPS**

Update your **Play Store** apps to get all the latest features and bug fixes.

1. Tap **Play store** > **≡** > **My apps & games** to see available updates.
2. Tap the app with an update available and **UPDATE** .

You can also update all apps at once. In **My apps & games** , tap **UPDATE ALL** .

## REMOVE DOWNLOADED APPS

Tap **Play Store** > **☰** > **My apps & games**, choose an app you want to remove, and tap **UNINSTALL**.

## GET MUSIC, MOVIES, OR BOOKS WITH GOOGLE PLAY

With Google Play, you can gain access to songs, movies, and books.

Tap **Music**, **Movies**, or **Books** to learn more.

<sup>1</sup> You need to have a Google account added to your phone to use Google Play services. Charges may apply to some of the content available in Google Play. To add a payment method, tap **Play Store** > **Menu** > **Account** > **Payment methods**. Always be sure to have a permission from the payment method owner when buying content from Google Play.

# Software updates and backups

## Update your phone software

Stay in step with the beat – update your phone software and apps wirelessly to get new and enhanced features for your phone. Updating the software may also improve your phone performance.

### INSTALL AVAILABLE UPDATES

Tap **Settings** > **System** > **Advanced** > **System updates** > **Update** to check if updates are available.

When your phone notifies you that an update is available, just follow the instructions shown on your phone.

**Warning:** If you install a software update, you cannot use the device, even to make emergency calls, until the installation is completed and the device is restarted.

Before starting the update, connect a charger or make sure the device battery has enough power, and connect to Wi-Fi, as the update packages may use up a lot of mobile data.

## Back up your data

To ensure your data is safe, use the backup feature in your phone. Your device data (such as Wi-Fi passwords and call history) and app data (such as settings and files stored by apps) will be backed up remotely.



## SWITCH ON AUTOMATIC BACKUP

Tap **Settings** > **System** > **Advanced** > **Backup** , and switch back up on.

## Restore original settings and remove private content from your phone

Accidents can happen – if your phone is not working properly, you can restore its settings. Or, if you buy a new phone, or otherwise want to dispose of or recycle your phone, here’s how you can remove your personal info and content. Note that it is your responsibility to remove all private content.

## RESET YOUR PHONE

1. Tap **Settings** > **System** > **Advanced** > **Reset options** > **Erase all data (factory reset)** .
2. Follow the instructions shown on your phone.

## Storage

To check how much memory you have available, tap **Settings** > **Storage** .

## REMOVE DOWNLOADED APPS

Tap **Play Store** > **≡** > **My apps & games** , choose an app you want to remove, and tap **UNINSTALL** .

## DISABLE AN APP

You can't delete some apps that were pre-installed on your device. But you can disable them and they will be hidden from the list of apps on your device. If you disable an app, you can add it back to your device.

1. Tap **Settings** > **Apps & notifications** .
2. Tap the app name.
3. Tap **DISABLE** . You may not be able to disable all apps.

If an installed app depends on a removed app, the installed app may stop working. For details, see the user documentation of the installed app.

## ADD BACK A DISABLED APP

You can add a disabled app back to the list of apps.

1. Tap **Settings** > **Apps & notifications** .
2. Tap the app name.
3. Tap **ENABLE** .

## COPY CONTENT BETWEEN YOUR PHONE AND COMPUTER

You can copy photos, videos, and other content created by you between your phone and computer to show or store them.

1. Connect your phone to a compatible computer with a compatible USB cable.
2. On your computer, open a file manager, and browse to your phone.
3. Drag and drop items from your phone to the computer, or from your computer to the phone.

Make sure you put the files in the right folders on your phone, or you may not be able to see them.

# Protect your phone

## Protect your phone with your fingerprint

You can unlock your phone with just a touch of your finger. Set up your fingerprint ID for extra security.

### **ADD A FINGERPRINT**

1. Tap **Settings** > **Security & Location** > **Fingerprint** . If you don't have screen lock set up on your phone, tap **Set up screen lock** .
2. Select what backup unlocking method you want to use for the lock screen and follow the instructions shown on your phone.

### **UNLOCK YOUR PHONE WITH YOUR FINGER**

Place your registered finger on the sensor. The fingerprint sensor is located on the phone display. Press your finger on  to unlock the phone.

If there is a fingerprint sensor error, and you cannot use alternative sign-in methods to recover or reset the phone in any way, your phone will require service. Additional charges may apply, and all the personal data on your phone may be deleted. For more info, contact the nearest care point for your phone, or your phone dealer.

## Change your SIM PIN code

If your SIM card came with a default SIM PIN code, you can change it to something more secure. Not all network service providers support this.

## SELECT YOUR SIM PIN

You can choose which digits to use for the SIM PIN. The SIM PIN code can be 4-8 digits.

1. Tap **Settings** > **Security & Location** > **Advanced** > **SIM card lock**.
2. Under the selected SIM card, tap **Change SIM PIN**.



**Tip:** If you don't want to protect your SIM with a PIN code, switch **Lock SIM card** to **Off**, and type in your current PIN.

## Access codes

Learn what the different codes on your phone are for.

### PIN OR PIN2 CODE

PIN or PIN2 codes have 4-8 digits.

These codes protect your SIM card against unauthorized use or are required to access some features. You can set your phone to ask for the PIN code when you switch it on.

If you forget the codes or they aren't supplied with your card, contact your network service provider.

If you type in the code incorrectly 3 times in a row, you need to unblock the code with the PUK or PUK2 code.

## **PUK OR PUK2 CODES**

PUK or PUK2 codes are required to unblock a PIN or PIN2 code.

If the codes are not supplied with your SIM card, contact your network service provider.

## **LOCK CODE**

Also known as security code or password.

The lock code helps you protect your phone against unauthorized use. You can set your phone to ask for the lock code that you define. Keep the code secret and in a safe place, separate from your phone.

If you forget the code and your phone is locked, your phone will require service. Additional charges may apply, and all the personal data on your phone may be deleted.

For more info, contact the nearest care point for your phone, or your phone dealer.

## **IMEI CODE**

The IMEI code is used to identify phones in the network. You may also need to give the number to your care point services or phone dealer.

To view your IMEI number, dial `*#06#`.

Your phone's IMEI code is also printed either on your phone or on the SIM tray depending on your phone model. If your phone has a removable back cover, you can find the IMEI code under the cover.

The IMEI is also visible on the original sales box.

## LOCATE OR LOCK YOUR PHONE

If you lose your phone, you may be able to find, lock, or erase it remotely if you have signed in to a Google Account. Find My Device is on by default for phones associated with a Google Account.

To use Find My Device, your lost phone must be:

- Turned on
- Signed in to a Google Account
- Connected to mobile data or Wi-Fi
- Visible on Google Play
- Location turned on
- Find My Device turned on

When Find My Device connects with your phone, you see the phone's location, and the phone gets a notification.

1. Open [android.com/find](https://android.com/find) on a computer, tablet or phone connected to the internet and sign in to your Google Account.
2. If you have more than one phone, click the lost phone at the top of the screen.
3. On the map, see about where the phone is. The location is approximate and may not be accurate.

If your device can't be found, Find My Device will show its last known location, if available. To lock or erase your phone, follow the instructions on the web site.

# Product and safety information

## For your safety

Read these simple guidelines. Not following them may be dangerous or against local laws and regulations. For further info, read the complete user guide.



### **SWITCH OFF IN RESTRICTED AREAS**

Switch the device off when mobile phone use is not allowed or when it may cause interference or danger, for example, in aircraft, in hospitals or near medical equipment, fuel, chemicals, or blasting areas. Obey all instructions in restricted areas.



### **ROAD SAFETY COMES FIRST**

Obey all local laws. Always keep your hands free to operate the vehicle while driving. Your first consideration while driving should be road safety.



## **INTERFERENCE**

All wireless devices may be susceptible to interference, which could affect performance.



## **AUTHORIZED SERVICE**

Only authorized personnel may install or repair this product.



## **BATTERIES, CHARGERS, AND OTHER ACCESSORIES**

Use only batteries, chargers, and other accessories approved by HMD Global Oy for use with this device. Do not connect incompatible products.





## KEEP YOUR DEVICE DRY

If your device is water-resistant, please refer to its IP rating for more detailed guidance.



## GLASS PARTS

The device and/or its screen is made of glass. This glass can break if the device is dropped on a hard surface or receives a substantial impact. If the glass breaks, do not touch the glass parts of the device or attempt to remove the broken glass from the device. Stop using the device until the glass is replaced by authorized service personnel.



## PROTECT YOUR HEARING

To prevent possible hearing damage, do not listen at high volume levels for long periods. Exercise caution when holding your device near your ear while the loudspeaker is in use.



## SAR

This device meets RF exposure guidelines when used either in the normal use position against the ear or when positioned at least 0.2 inches (5 mm) away from the body. The specific maximum SAR values can be found in the Certification Information (SAR) section of this user guide. For more info, go to [www.sar-tick.com](http://www.sar-tick.com).

When a carry case, belt clip or other form of device holder is used for body-worn operation, it should not contain metal and should provide at least the above-stated separation distance from the body. Note that mobile devices may be transmitting even if you are not making a voice call.

## Network services and costs

Using some features and services, or downloading content, including free items, require a network connection. This may cause the transfer of large amounts of data, which may result in data costs. You may also need to subscribe to some features.



**Important:** 4G/LTE might not be supported by your network service provider or by the service provider you are using when traveling. In these cases, you may not be able to make or receive calls, send or receive messages or use mobile data connections. To make sure your device works seamlessly when full 4G/LTE service is not available, it is recommended that you change the highest connection speed from 4G to 3G. To do this, on the home screen, tap **Settings** > **Network & Internet** > **Mobile network**, and switch **Preferred**

network type to 3G.



**Note:** Using Wi-Fi may be restricted in some countries. For example, in the EU, you are only allowed to use 5150–5350 MHz Wi-Fi indoors, and in the USA and Canada, you are only allowed to use 5.15–5.25 GHz Wi-Fi indoors. For more info, contact your local authorities. For more info, contact your network service provider.

## Emergency calls



**Important:** Connections in all conditions cannot be guaranteed. Never rely solely on any wireless phone for essential communications like medical emergencies.

Before making the call:

- Switch the phone on.
- If the phone screen and keys are locked, unlock them.
- Move to a place with adequate signal strength.

On the home screen, tap .

1. Type in the official emergency number for your present location. Emergency call numbers vary by location.
2. Tap .
3. Give the necessary info as accurately as possible. Do not end the call until given permission to do so.

You may also need to do the following:

- Put a SIM card in the phone. If you don't have a SIM, on the lock screen, tap **Emergency**.
- If your phone asks for a PIN code, tap **Emergency**.
- Switch the call restrictions off in your phone, such as call barring, fixed dialling, or closed user group.
- If the mobile network is not available, you may also try making an internet call, if you can access the internet.

## Take care of your device

Handle your device, battery, charger and accessories with care. The following suggestions help you keep your device operational.

- Keep the device dry. Precipitation, humidity, and all types of liquids or moisture can contain minerals that
- Do not drop, knock, or shake the device or the battery. Rough handling can break it.

- corrode electronic circuits.
- Do not use or store the device in dusty or dirty areas.
- Do not store the device in high temperatures. High temperatures may damage the device or battery.
- Do not store the device in cold temperatures. When the device warms to its normal temperature, moisture can form inside the device and damage it.
- Do not open the device other than as instructed in the user guide.
- Unauthorized modifications may damage the device and violate regulations governing radio devices.
- Only use a soft, clean, dry cloth to clean the surface of the device.
- Do not paint the device. Paint can prevent proper operation.
- Keep the device away from magnets or magnetic fields.
- To keep your important data safe, store it in at least two separate places, such as your device, memory card, or computer, or write down important info.

During extended operation, the device may feel warm. In most cases, this is normal. To avoid getting too warm, the device may automatically slow down, close apps, switch off charging, and if necessary, switch itself off. If the device is not working properly, take it to the nearest authorized service facility.

## Recycle



Always return your used electronic products, batteries, and packaging materials to dedicated collection points. This way you help prevent uncontrolled waste disposal and promote the recycling of materials. Electrical and electronic products contain a lot of valuable materials, including metals (such as copper, aluminum, steel, and magnesium) and precious metals (such as gold, silver, and palladium). All materials of the device can be recovered as materials and energy.

## Crossed-out wheelie bin symbol



### **CROSSED-OUT WHEELIE BIN SYMBOL**

The crossed-out wheelie bin symbol on your product, battery, literature, or packaging reminds you that all electrical and electronic products and batteries must be taken to separate collection at the end of their working life. Do not dispose of these products as unsorted municipal waste: take them for recycling. For info on your nearest recycling point, check with your local waste authority.

## Battery and charger information

### **BATTERY AND CHARGER INFO**

To check if your phone has a removable or non-removable battery, see the Get started guide.

#### **Devices with a removable battery**

Use your device only with an original rechargeable battery. The battery can be charged and discharged hundreds of times, but it will eventually wear out. When the talk and standby times are noticeably shorter than normal, replace the battery.

#### **Devices with a non-removable battery**

Do not attempt to remove the battery, as you may damage the device. To replace the battery, take the device to the nearest authorized service facility.

The battery can be charged and discharged hundreds of times, but it will eventually wear out. When the talk and standby times are noticeably shorter than normal, to

replace the battery, take the device to the nearest authorized service facility.

Charge your device with the provided charger. Charger plug type may vary. Charging time can vary depending on device capability.

## **BATTERY AND CHARGER SAFETY INFO**

Once charging of your device is complete, unplug the charger from the device and electrical outlet. Please note that continuous charging should not exceed 12 hours. If left unused, a fully charged battery will lose its charge over time.

Always keep the battery between 15°C and 25°C (59°F and 77°F) for optimal performance. Extreme temperatures reduce the capacity and lifetime of the battery. A device with a hot or cold battery may not work temporarily.

Do not dispose of batteries in a fire as they may explode. Obey local regulations. Recycle when possible. Do not dispose as household waste.

Do not dismantle, cut, crush, bend, puncture, or otherwise damage the battery in any way. If a battery leaks, do not let liquid touch skin or eyes. If this happens, immediately flush the affected areas with water, or seek medical help. Do not modify, attempt to insert foreign objects into the battery, or immerse or expose it to water or other liquids. Batteries may explode if damaged.

Use the battery and charger for their intended purposes only. Improper use, or use of unapproved or incompatible batteries or chargers may present a risk of fire, explosion, or other hazard, and may invalidate any approval or warranty. If you believe the battery or charger is damaged, take it to a service centre or your phone dealer before continuing to use it. Never use a damaged battery or charger. Only use the charger indoors. Do not charge your device during a lightning storm.

Additionally, the following applies if your device has a removable battery:

- Always switch the device off and unplug the charger before removing the battery. To unplug a charger or an accessory, hold and pull the plug, not the cord.
- Accidental short-circuiting can happen when a metallic object touches the metal strips on the battery. This may damage the battery or the other object.

## Small children

Your device and its accessories are not toys. They may contain small parts. Keep them out of the reach of small children.

## Medical devices

Operation of radio transmitting equipment, including wireless phones, may interfere with inadequately shielded medical devices' function. Consult a physician or the medical device's manufacturer to determine if it is adequately shielded from external radio energy.

## Implanted medical devices

To avoid potential interference, manufacturers of implanted medical devices recommend a minimum separation of 15.3 centimeters (6 inches) between a wireless device and the medical device. Persons who have such devices should:

- Always keep the wireless device more than 15.3 centimeters (6 inches) from the medical device.
- Not carry the wireless device in a breast pocket.
- Hold the wireless device to the ear opposite the medical device.
- Switch the wireless device off if there is any reason to suspect that interference is taking place.
- Follow the manufacturer directions for the implanted medical device.

If you have any questions about using your wireless device with an implanted medical device, consult your health care provider.

## Hearing



**Warning:** When you use the headset, your ability to hear outside sounds may be affected. Do not use the headset where it can endanger your safety.

Some wireless devices may interfere with some hearing aids.

## Protect your device from harmful content

Your device may be exposed to viruses and other harmful content. Take the following precautions:

- Be cautious when opening messages. They may contain malicious software or otherwise be harmful to your device or computer.
- Be cautious when accepting connectivity requests, browsing the internet, or downloading content. Do not accept Bluetooth connections from sources you do not trust.
- Only install and use services and software from sources that you trust and that offer adequate security and protection.
- Install antivirus and other security software on your device and any connected computer. Only use one antivirus app at a time. Using more may affect performance and operation of the device and/or computer.
- If you access preinstalled bookmarks and links to third party internet sites, take the appropriate precautions. HMD Global does not endorse or assume liability for such sites.

## Vehicles

Radio signals may affect improperly installed or inadequately shielded electronic systems in vehicles. For more info, check with the manufacturer of your vehicle or its equipment.

Only authorized personnel should install the device in a vehicle. Faulty installation may be dangerous and invalidate your warranty. Check regularly that all wireless device equipment in your vehicle is mounted and operating properly. Do not store or carry flammable or explosive materials in the same compartment as the device, its parts, or accessories. Do not place your device or accessories in the air bag deployment area.



## Potentially explosive environments

Switch your device off in potentially explosive environments, such as near gasoline pumps. Sparks may cause an explosion or fire resulting in injury or death. Note restrictions in areas with fuel; chemical plants; or where blasting operations are in progress. Areas with a potentially explosive environment may not be clearly marked. These usually are areas where you are advised to switch your engine off, below deck on boats, chemical transfer or storage facilities, and where the air contains chemicals or particles. Check with the manufacturers of vehicles using liquefied petroleum gas (such as propane or butane) if this device can be safely used in their vicinity.

## Wet or dusty conditions

This device has been given a rating of IP67 for dust and water resistance based on tests done in standby mode under controlled laboratory conditions. This resistance is not a permanent condition, and may decrease as a result of normal wear.

Water resistance means resistance against cold, clean fresh water only. Do not expose the device to any other type of liquid, (such as sea water, soap water, pool water, detergent, acids or solvents, perfume, adhesive remover, hair dye, lotions, sunscreen or oil). Do not submerge the device in water. If the device has been exposed to water, wipe it off with a dry cloth. If it has been exposed to any other liquid, immediately splash some clean fresh water onto the device. Carefully wipe the device dry. Do not charge the device or connect anything if the connectors are dusty, wet, or damp.

**Important:** Liquid damage is not covered under warranty. To prevent liquid damage, avoid swimming or bathing with the device, exposing it to pressurized or high velocity water (such as when showering, surfing or jet skiing), using the device in a sauna or steam room, intentionally submerging the device in water, or using the device outside the suggested temperature ranges or in high humidity conditions.

**Important:** Accessories for use with this device are not as water-resistant as the device itself. For example, chargers should only be used in dry conditions, never when damp or wet.

## Certification information (SAR)

### **This mobile device meets guidelines for exposure to radio waves.**

Your mobile device is a radio transmitter and receiver. It is designed not to exceed the limits for exposure to radio waves (radio frequency electromagnetic fields), recommended by international guidelines from the independent scientific organization ICNIRP. These guidelines incorporate substantial safety margins that are intended to assure the protection of all persons regardless of age and health. The exposure guidelines are based on the Specific Absorption Rate (SAR), which is an expression of the amount of radio frequency (RF) power deposited in the head or body when the device is transmitting. The ICNIRP SAR limit for mobile devices is 2.0 W/kg averaged over 10 grams of tissue.

SAR tests are carried out with the device in standard operating positions, transmitting at its highest certified power level, in all its frequency bands.

Please refer to [www.nokia.com/phones/sar](http://www.nokia.com/phones/sar) for the maximum SAR value of the device.

This device meets RF exposure guidelines when used against the head or when positioned at least 5/8 inch (1.5 centimetres) away from the body. When a carry case, belt clip or other form of device holder is used for body-worn operation, it should not contain metal and should provide at least the above stated separation distance from the body.

To send data or messages, a good connection to the network is needed. Sending may be delayed until such a connection is available. Follow the separation distance instructions until the sending is finished.

During general use, the SAR values are usually well below the values stated above. This is because, for purposes of system efficiency and to minimize interference on the network, the operating power of your mobile is automatically decreased when full power is not needed for the call. The lower the power output, the lower the SAR value.

Device models may have different versions and more than one value. Component and design changes may occur over time and some changes could affect SAR values.

For more info, go to [www.sar-tick.com](http://www.sar-tick.com). Note that mobile devices may be

transmitting even if you are not making a voice call.

The World Health Organization (WHO) has stated that current scientific information does not indicate the need for any special precautions when using mobile devices. If you are interested in reducing your exposure, they recommend you limit your usage or use a hands-free kit to keep the device away from your head and body. For more information and explanations and discussions on RF exposure, go to the WHO website at [www.who.int/peh-emf/en](http://www.who.int/peh-emf/en).

## About Digital Rights Management

When using this device, obey all laws and respect local customs, privacy and legitimate rights of others, including copyrights. Copyright protection may prevent you from copying, modifying, or transferring photos, music, and other content.

## Copyrights and notices

### **COPYRIGHTS AND OTHER NOTICES**

The availability of products, features, apps and services may vary by region. For more info, contact your dealer or your service provider. This device may contain commodities, technology or software subject to export laws and regulations from the US and other countries. Diversion contrary to law is prohibited.

The contents of this document are provided "as is". Except as required by applicable law, no warranties of any kind, either express or implied, including, but not limited to, the implied warranties of merchantability and fitness for a particular purpose, are made in relation to the accuracy, reliability or contents of this document. HMD Global reserves the right to revise this document or withdraw it at any time without prior notice.

To the maximum extent permitted by applicable law, under no circumstances shall HMD Global or any of its licensors be responsible for any loss of data or income or any special, incidental, consequential or indirect damages howsoever caused.

Reproduction, transfer or distribution of part or all of the contents in this document in any form without the prior written permission of HMD Global is prohibited. HMD

Global operates a policy of continuous development. HMD Global reserves the right to make changes and improvements to any of the products described in this document without prior notice.

HMD Global does not make any representations, provide a warranty, or take any responsibility for the functionality, content, or end-user support of third-party apps provided with your device. By using an app, you acknowledge that the app is provided as is.

Downloading of maps, games, music and videos and uploading of images and videos may involve transferring large amounts of data. Your service provider may charge for the data transmission. The availability of particular products, services and features may vary by region. Please check with your local dealer for further details and availability of language options.

Certain features, functionality and product specifications may be network dependent and subject to additional terms, conditions, and charges.

All specifications, features and other product information provided are subject to change without notice.

HMD Global Privacy Policy, available at <http://www.nokia.com/phones/privacy>, applies to your use of the device.

HMD Global Oy is the exclusive licensee of the Nokia brand for phones & tablets. Nokia is a registered trademark of Nokia Corporation.

ZEISS and the ZEISS logo are registered trademarks of Carl Zeiss AG used under license of Carl Zeiss Vision GmbH.

Google, Android, Google Play and other marks are trademarks of Google LLC.

The 'Qi' symbol is a trademark of the Wireless Power Consortium.

The Bluetooth word mark and logos are owned by the Bluetooth SIG, Inc. and any use of such marks by HMD Global is under license.

## OZO



OZO is a trademark of Nokia Technologies Oy.

## QUALCOMM APTX



Qualcomm and Snapdragon are trademarks of Qualcomm Incorporated, registered in the United States and other countries. aptX is a trademark of Qualcomm Technologies International, Ltd., registered in the United States and other countries.

## HAC NOTICE

Your phone is compliant with the FCC Hearing Aid Compatibility requirements. The FCC has adopted HAC rules for digital wireless phones. These rules require certain phone to be tested and rated under the American National Standard Institute (ANSI) C63.19-2011 hearing aid compatibility standards. The ANSI standard for hearing aid compatibility contains two types of ratings:

M-Ratings: Rating for less radio frequency interference to enable acoustic coupling with hearing aids.

T-Ratings: Rating for inductive coupling with hearing aids in telecoil mode.

Not all phones have been rated, a phone is considered hearing aid compatible under FCC rules if it is rated M3 or M4 for acoustic coupling and T3 or T4 for inductive coupling. These ratings are given on a scale from one to four, where four is the most compatible. Your phone meets the M3/T4 level rating.

However, hearing aid compatibility ratings don't guarantee that interference to your hearing aids won't happen. Results will vary, depending on the level of immunity of your hearing device and the degree of your hearing loss. If your hearing device happens to be vulnerable to interference, you may not be able to use a rated phone successfully. Trying out the phone with your hearing device is the best way to evaluate it for your personal needs.

This phone has been tested and rated for use with hearing aids for some of the wireless technologies that it uses. However, there may be some newer wireless technologies used in this phone that have not been tested yet for use with hearing aids. It is important to try the different features of this phone thoroughly and in different locations, using your hearing aid or cochlear implant, to determine if you hear any interfering noise. Consult your service provider or the manufacturer of this phone for information on hearing aid compatibility. If you have questions about return or exchange policies, consult your service provider or phone retailer.

Hearing devices may also be rated. Your hearing device manufacturer or hearing health professional may help you find this rating. For more information about FCC Hearing Aid Compatibility, please go to <http://www.fcc.gov/cgb/dro>.