

# FABRICUT<sup>®</sup>

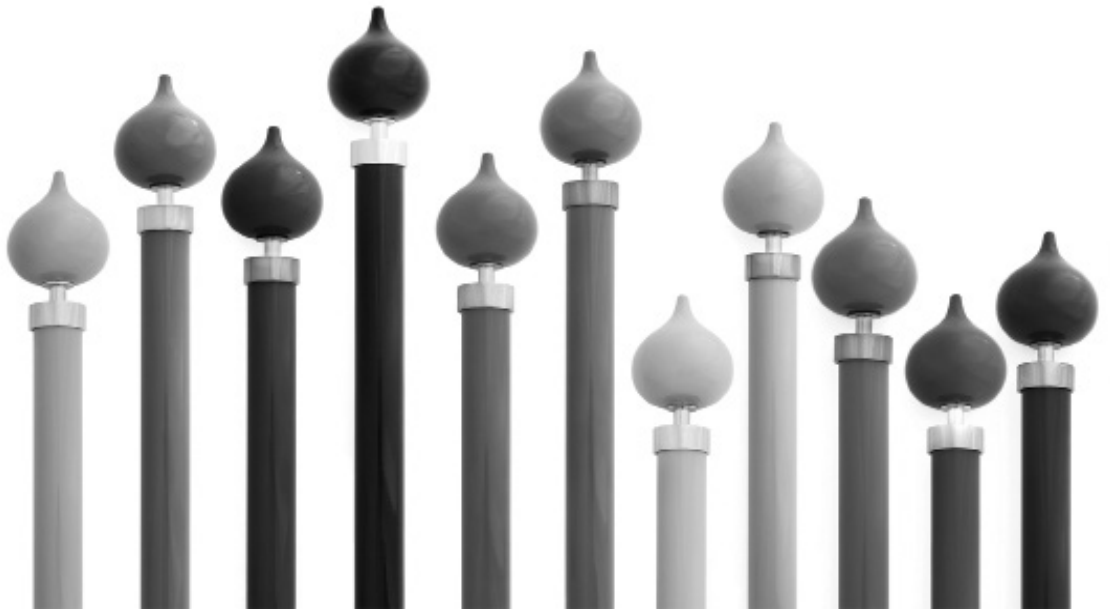

BYRON & BYRON  
DECORATIVE DRAPERY  
HARDWARE

Retail Price List

April 1, 2024



# BYRON & BYRON COLLECTIONS

## TABLE OF CONTENTS

---

GENERAL INFORMATION/TERMS	58-61
PRODUCT AND FINISH MANUAL	62-65

---

### HALO COLLECTION - ACRYLIC

1 3/8" - 35mm	4-5
1 3/4" - 45mm	6-7
2 1/8" - 55mm	8-9

### HALO COLLECTION - WASHED WOOD

1 3/8" - 35mm	10-11
1 3/4" - 45mm	12-13
2 1/8" - 55mm	14-15

### HALO COLLECTION - GLOSS

1 3/8" - 35mm	16-17
1 3/4" - 45mm	18-19
2 1/8" - 55mm	20-21
Wands	21

### BARNWOOD COLLECTION

1 3/8" - 35mm	22-23
1 3/4" - 45mm	24-25
2 1/8" - 55mm	26-27
Wands	26
Holdbacks	27

### RUSTICA COLLECTION

1 3/8" - 35mm	28-29
1 3/4" - 45mm	30-31
2 1/8" - 55mm	32-33
Wands	32
Holdbacks	33

### NEON FLORAL COLLECTION

1 3/8" - 35mm	34-35
1 3/4" - 45mm	36-37
2 1/8" - 55mm	38-39
Wands	38
Holdbacks	39

### ROMANTIC FLORAL COLLECTION





1 3/8" - 35mm	40-41
1 3/4" - 45mm	42-43
2 1/8" - 55mm	44-45
Holdbacks & Wands	46







### BESPOKE COLLECTION

Finish/Colors	47
1 3/8" - 35mm	48-49
1 3/4" - 45mm	50-51
2 1/8" - 55mm	52-53
Wands	52
Holdbacks	53
Banding	54-57

# HALO COLLECTION

## ACRYLIC - 1 3/8" - 35 mm

1 3/8" - 35mm FINIALS & END CAPS					
Item Number	Item Name	Dimensions Inches / Metric	Material	Retail Price Each	
 BYF3510F	Stellar	2 3/4" H x 4 1/2" L 70mm H x 114mm L	Acrylic/Metal	\$308.00	
 BYF3511F	Luna	3 1/8" H x 3 5/8" L 76mm H x 92mm L	Acrylic/Metal	\$222.00	
 BYF3512F	Globus	2 3/4" H x 4" L 68mm H x 100mm L	Acrylic/Metal	\$188.00	
 BYF3513F	Orion	2 7/8" H x 2 7/8" L 74mm H x 72mm L	Acrylic Metal	\$330.00	
 BYF3514F	End Cap	1 3/4" H x 1" L 43mm H x 25mm L	Metal	\$116.00	

1 3/8" - 35mm POLES* & RINGS					
Item Number	Item Name	Dimensions Inches / Metric	Top of Pole to Eyelet	Material	Retail Price Each
 BYHP320F	6.5' Pole* Hollow Acrylic	78 3/4" L 200cm L		Acrylic	\$328.00
 BYHP330F	8' Pole* Hollow Acrylic	96 1/8" L 244cm L		Acrylic	\$460.00
 BYAP321F	6.5' Pole* Solid Acrylic	78 3/4" L 200cm L		Acrylic	\$386.00
 BYAP331F	8' Pole* Solid Acrylic	96 1/8" L 244cm L		Acrylic	\$576.00
 BYR3650F	Metal Ring	2 3/8" OD - 2" ID - 1/4" W 60mm OD - 50mm ID - 6mm W	2 5/8" 67 mm	Metal	\$14.00
 BYR3651F	Metal Passing Ring	2 3/8" OD - 2" ID - 1/4" W 60mm OD - 50mm ID - 6mm W	2 5/8" 67 mm	Metal	\$16.00
 BYR3652F	Acrylic Ring*	2 1/8" OD - 1 3/4" ID - 3/8" W 55mm OD - 45mm ID - 10mm W	2 1/2" 65 mm	Acrylic	\$16.00

\* Splicing not available. Central joining bracket required to join two or more poles together.

\*\* Note: Actual pole lengths are not in full feet.

\*Review Actual pole lengths in inches listed above before ordering.

\* See page 60 for maximum drapery weights.











### HALO ACRYLIC FINISHES

FINIALS	Acrylic/Chrome 841	Acrylic/Burnished Brass 811	Acrylic/Copper 861
METAL END CAPS, BRACKETS & RINGS	Chrome 840	Burnished Brass 810	Copper 860
ACRYLIC RINGS, WAND & POLES	Clear Acrylic 990		



# HALO COLLECTION

## ACRYLIC - 1 3/8" - 35 mm

1 3/8" - 35mm BRACKETS						
Item Number	Item Name	Dimensions Inches / Metric	Projection	Material	Retail Price Each	
	BYB3570F	Standard End 4 3/8" H x 1 1/8" Base x 5 1/2" L 110mm H x 30mm Base x 139mm L	4 1/2" 113mm	Metal	\$230.00	
	BYB3571F	Standard Central 1 5/8" H x 3 1/2" Base x 5 1/2" L 40mm H x 88mm Base x 139mm L	4 1/2" 113mm	Metal	\$230.00	
	BYB3572F	Adjustable Passing 2" H x 2" Base x 5 1/4" L 50mm H x 50mm Base x 133mm L	4 1/2" - 6 1/2" 114mm - 165mm	Metal	\$146.00	
	BYB3573F	Central Joining 1 5/8" H x 3 1/2" Base x 5 1/2" L 40mm H x 88mm Base x 139mm L	4 1/2" 113mm	Metal	\$268.00	
	BYB3574F	Extended End 4 3/8" H x 1 1/8" Base x 7 3/8" L 110mm H x 30mm Base x 186mm L	6 1/4" 160mm	Metal	\$268.00	
	BYB3575F	Extended Central 1 5/8" H x 3 1/2" Base x 7 3/8" L 40mm H x 88mm Base x 186mm L	6 1/4" 160mm	Metal	\$268.00	
	BYB3578F	Inside Mount Open 1 7/8" Base x 1" L 47mm W x 26mm L	1/4" 6mm	Metal	\$116.00	
	BYB3579F	Inside Mount Closed 1 7/8" Base x 1" L 47mm Base x 26mm L	1/4" 6mm	Metal	\$116.00	
	BYB3580F	Extended Central Joining 1 5/8" H x 3 1/2" Base x 7 3/8" L 40mm H x 88mm Base x 186mm L	6 1/4" 160mm	Metal	\$306.00	
	BYB3582F	Adjustable Extended Passing 2" H x 2" Base x 7 1/8" L 50mm H x 50mm Base x 180mm L	6 1/4" - 8 1/4" 160mm - 209mm	Metal	\$194.00	
	BYB3590F	Elbow Bracket 1 3/8" Base x 4 1/4" L from center 35mm Base x 108mm L from center		Acrylic	\$244.00	





Bracket support recommended every 3 ft - 91.44cm for acrylic poles. Every 4 ft - 120cm for wood.







### HALO ACRYLIC FINISHES

FINIALS	Acrylic/Chrome 841	Acrylic/Burnished Brass 811	Acrylic/Copper 861
METAL END CAPS, BRACKETS & RINGS	Chrome 840	Burnished Brass 810	Copper 860
ACRYLIC RINGS, WAND & POLES	Clear Acrylic 990		

# HALO COLLECTION

## ACRYLIC - 1 3/4" - 45 mm

1 3/4" - 45mm FINIALS & END CAPS					
Item Number	Item Name	Dimensions Inches / Metric		Material	Retail Price Each
 BYF4510F	Stellar	3 1/4" H x 5" L 82mm H x 126mm L		Acrylic/Metal	\$332.00
 BYF4511F	Luna	3 3/8" H x 4" L 85mm H x 100mm L		Acrylic/Metal	\$316.00
 BYF4512F	Globus	3" H x 4 3/8" L 75mm H x 110mm L		Acrylic/Metal	\$280.00
 BYF4513F	Orion	3 1/4" H x 3 7/8" L 83mm H x 97mm L		Acrylic Metal	\$390.00
 BYF4514F	End Cap	2 1/8" H x 1 1/8" L 53mm H x 29mm L		Metal	\$128.00

1 3/4" - 45mm POLES* & RINGS						
Item Number	Item Name	Dimensions Inches / Metric		Top of Pole to Eyelet	Material	Retail Price Each
 BYHP420F	6.5' Pole* Hollow Acrylic	78 3/4" L 200cm L			Acrylic	\$504.00
 BYHP430F	8' Pole* Hollow Acrylic	96 1/8" L 244cm L			Acrylic	\$752.00
 BYAP421F	6.5' Pole* Solid Acrylic	78 3/4" L 200cm L			Acrylic	\$634.00
 BYAP431F	8' Pole* Solid Acrylic	96 1/8" L 244cm L			Acrylic	\$944.00
 BYR4650F	Metal Ring	2 3/4" OD - 2 1/4" ID - 1/4" W 70mm OD - 60mm ID - 6mm W		3" 76mm	Metal	\$16.00
 BYR4651F	Metal Passing Ring	2 3/4" OD - 2 1/4" ID - 1/4" W 70mm OD - 60mm ID - 6mm W		3" 76mm	Metal	\$16.00
 BYR4652F	Acrylic Ring*	2 1/2" OD - 2 1/4" ID - 3/8" W 65mm OD - 55mm ID - 10mm W		3" 76mm	Acrylic	\$20.00

\* Splicing not available. Central joining bracket required to join two or more poles together.

\*\* Note: Actual pole lengths are not in full feet. Maximum length in wood is 94 1/2" - 240cm.

\*Review Actual pole lengths in inches listed above before ordering.















\* See page 60 for maximum drapery weights.

### HALO ACRYLIC FINISHES

FINIALS	Acrylic/Chrome 841	Acrylic/Burnished Brass 811	Acrylic/Copper 861
METAL END CAPS, BRACKETS & RINGS	Chrome 840	Burnished Brass 810	Copper 860
ACRYLIC RINGS, WAND & POLES	Clear Acrylic 990		

# HALO COLLECTION

## ACRYLIC - 1 3/4" - 45 mm

1 3/4" - 45mm BRACKETS						
Item Number	Item Name	Dimensions Inches / Metric	Projection	Material	Retail Price Each	
 BYB4570F	Standard End	4 3/8" H x 1 1/8" Base x 5 5/8" L 110mm H x 30mm Base x 144mm L	4 1/2" 113mm	Metal	\$256.00	
 BYB4571F	Standard Central	1 5/8" H x 3 1/2" Base x 5 5/8" L 40mm H x 88mm Base x 144mm L	4 1/2" 113mm	Metal	\$256.00	
 BYB4572F	Adjustable Passing	2" H x 2" Base x 5 1/4" L 50mm H x 50mm Base x 134mm L	4 1/2" - 6 1/2" 114mm - 165mm	Metal	\$162.00	
 BYB4573F	Central Joining	1 5/8" H x 3 1/2" Base x 5 5/8" L 40mm H x 88mm Base x 144mm L	4 1/2" 113mm	Metal	\$296.00	
 BYB4574F	Extended End	4 3/8" H x 1 1/8" Base x 7 1/2" L 110mm H x 30mm Base x 191mm L	6 1/4" 160mm	Metal	\$296.00	
 BYB4575F	Extended Central	1 5/8" H x 3 1/2" Base x 7 1/2" L 40mm H x 88mm Base x 191mm L	6 1/4" 160mm	Metal	\$296.00	
 BYB4576F	Double End (35mm/45mm)	4 3/8" H x 1 1/8" Base x 10" L 110mm H x 30mm Base x 254mm L	5 5/8" - 143mm (BP) 8 3/4" - 223mm (FP)	Metal	\$336.00	
 BYB4577F	Double Central (35mm/45mm)	1 5/8" H x 3 1/2" Base x 10" L 40mm H x 88mm Base x 254mm L	5 5/8" - 143mm (BP) 8 3/4" - 223mm (FP)	Metal	\$336.00	
 BYB4578F	Inside Mount Open	2 1/4" Base x 1 1/8" L 58mm Base x 29mm L	1/4" 6mm	Metal	\$128.00	
 BYB4579F	Inside Mount Closed	2 1/4" Base x 1 1/8" L 58mm Base x 29mm L	1/4" 6mm	Metal	\$128.00	
 BYB4580F	Extended Central Joining	1 5/8" H x 3 1/2" Base x 7 1/2" L 40mm H x 88mm Base x 191mm L	6 1/4" 160mm	Metal	\$340.00	
 BYB4581F	Ext. Central Double Joining (35mm/45mm)	1 5/8" H x 3 1/2" Base x 10" L 40mm H x 88mm Base x 254mm L	5 5/8" - 143mm (BP) 8 3/4" - 223mm (FP)	Metal	\$384.00	
 BYB4582F	Adjustable Extended Passing	2" H x 2" Base x 7 1/4" L 50mm H x 50mm Base x 184mm L	6 1/4" - 8 1/4" 160mm - 209 mm	Metal	\$210.00	
 BYB4590F	Elbow Bracket	1 3/4" Base x 4 3/4" L from center 45mm Base x 120.5mm L from center		Acrylic	\$300.00	

Bracket support recommended every 3 ft - 91.44cm for acrylic poles. Every 4 ft - 120cm for wood.





### HALO ACRYLIC FINISHES

FINIALS	Acrylic/Chrome 841	Acrylic/Burnished Brass 811	Acrylic/Copper 861
METAL END CAPS, BRACKETS & RINGS	Chrome 840	Burnished Brass 810	Copper 860
ACRYLIC RINGS, WAND & POLES	Clear Acrylic 990		







# HALO COLLECTION

## ACRYLIC - 2 1/8" - 55 mm

### 2 1/8" - 55mm FINIALS & END CAPS

Item Number	Item Name	Dimensions Inches / Metric	Material	Retail Price Each
 BYF5510F	Stellar	3 1/2" H x 6 5/8" L 89mm H x 168mm L	Acrylic/Metal	\$458.00
 BYF5512F	Globus	3 1/2" H x 5 3/8" L 90mm H x 135mm L	Acrylic/Metal	\$426.00
 BYF5513F	Orion	4 1/2" H x 5" L 113mm H x 128mm L	Acrylic/Metal	\$532.00
 BYF5514F	End Cap	2 1/2" H x 1 3/8" L 63mm H x 34mm L	Metal	\$140.00

### 2 1/8" - 55mm POLES\* & RINGS

Item Number	Item Name	Dimensions Inches / Metric	Top of Pole to Eyelet	Material	Retail Price Each
 BYHP520F	6.5' Pole* Hollow Acrylic	78 3/4" L 200cm L		Acrylic	\$678.00
 BYHP530F	8' Pole* Hollow Acrylic	96 1/8" L 244cm L		Acrylic	\$1016.00
 BYAP521F	6.5' Pole* Solid Acrylic	78 3/4" L 200cm L		Acrylic	\$848.00
 BYAP531F	8' Pole* Solid Acrylic	96 1/8" L 244cm L		Acrylic	\$1272.00
 BYR5650F	Metal Ring	3 1/8" OD - 2 3/4" ID - 1/4" W 80mm OD - 70mm ID - 8mm	3 3/8" 85mm	Metal	\$22.00
 BYR5651F	Metal Passing Ring	3 1/8" OD - 2 3/4" ID - 1/4" W 80mm OD - 70mm ID - 8mm W	3 3/8" 85mm	Metal	\$26.00
 BYR5652F	Acrylic Ring*	3" OD - 2 1/2" ID - 1/2" W 75mm OD - 65mm ID - 12mm W	3 3/8" 85mm	Acrylic	\$28.00

\* Splicing not available. Central joining bracket required to join two or more poles together.

\*\* Note: Actual pole lengths are not in full feet. Maximum length in wood is 94 1/2" - 240cm.

\*Review Actual pole lengths in inches listed above before ordering.











\* See page 60 for maximum drapery weights.

#### HALO ACRYLIC FINISHES

FINIALS	Acrylic/Chrome 841	Acrylic/Burnished Brass 811	Acrylic/Copper 861
METAL END CAPS, BRACKETS & RINGS	Chrome 840	Burnished Brass 810	Copper 860
ACRYLIC RINGS, WAND & POLES	Clear Acrylic 990		

# HALO COLLECTION

## ACRYLIC - 2 1/8" - 55 mm

2 1/8" - 55mm BRACKETS						
	Item Number	Item Name	Dimensions Inches / Metric	Projection	Material	Retail Price Each
	BYB5570F	Standard End	4 7/8" H x 1 1/8" Base x 6 1/4" L 125mm H x 30mm Base x 160mm	4 7/8" 123mm	Metal	\$280.00
	BYB5571F	Standard Central	2" H x 4 3/8" Base x 6 1/4" L 50mm H x 110mm Base x 160mm L	4 7/8" 123mm	Metal	\$280.00
	BYB5572F	Adjustable Passing	2 1/8" H x 2 1/8" Base x 6" L 55mm H x 55mm Base x 152mm L	4 7/8" - 6 7/8" 123mm - 174mm	Metal	\$176.00
	BYB5573F	Central Joining	2" H x 4 3/8" Base x 6 1/4" L 50mm H x 110mm Base x 160mm L	4 7/8" 123mm	Metal	\$320.00
	BYB5574F	Extended End	4 7/8" H x 1 1/8" Base x 7 3/4" L 125mm H x 30mm Base x 196mm L	6 1/4" 160mm	Metal	\$320.00
	BYB5575F	Extended Central	2" H x 4 3/8" Base x 7 3/4" L 50mm H x 110mm Base x 196mm L	6 1/4" 160mm	Metal	\$320.00
	BYB5578F	Inside Mount Open	2 3/4" Base x 1 3/8" L 69mm Base x 34mm L	1/4" 6mm	Metal	\$146.00
	BYB5579F	Inside Mount Closed	2 3/4" Base x 1 3/8" L 69mm Base x 34mm L	1/4" 6mm	Metal	\$146.00
	BYB5580F	Extended Central Joining	2" H x 4 3/8" Base x 7 3/4" L 50mm H x 110mm Base x 196mm L	6 1/4" 160mm	Metal	\$368.00
	BYB5582F	Adjustable Extended Passing	2 1/8" H x 2 1/8" Base x 7 1/2" L 55mm H x 55mm Base x 190mm L	6 1/4" - 8 1/4" 160mm - 209mm	Metal	\$228.00
	BYB5590F	Elbow Bracket	2 1/8" Base x 5 1/4" L from center 55mm Base x 134mm from center		Acrylic	\$354.00





Bracket support recommended every 3 ft - 91.44cm for acrylic poles. Every 4 ft - 120cm for wood.

### HALO ACRYLIC FINISHES

FINIALS	Acrylic/Chrome 841	Acrylic/Burnished Brass 811	Acrylic/Copper 861
METAL END CAPS, BRACKETS & RINGS	Chrome 840	Burnished Brass 810	Copper 860
ACRYLIC RINGS, WAND & POLES	Clear Acrylic 990		

# HALO COLLECTION

## WASHED WOOD - 1 3/8" - 35 mm

1 3/8" - 35mm FINIALS & END CAPS					
	Item Number	Item Name	Dimensions Inches / Metric	Material	Retail Price Each
	BYF3520F	Stellar	2 3/4" H x 4 1/2" L 70mm H x 114mm L	Wood/Metal	\$276.00
	BYF3521F	Luna	3" H x 3 3/8" L 76mm H x 85mm L	Wood/Metal	\$206.00
	BYF3522F	Globus	2 5/8" H x 3 7/8" L 68mm H x 100mm L	Wood/Metal	\$180.00
	BYF3523F	Orion	2 7/8" H x 2 7/8" L 74mm H x 72mm L	Wood/Metal	\$234.00
	BYF3514F	End Cap	1 3/4" H x 1" L 43mm H x 25mm L	Metal	\$116.00

1 3/8" - 35mm POLES* & RINGS						
	Item Number	Item Name	Dimensions Inches / Metric	Top of Pole to Eyelet	Material	Retail Price Each
	BYHP320F	6.5' Pole* Hollow Acrylic	78 3/4" L 200cm L		Acrylic	\$328.00
	BYHP330F	8' Pole* Hollow Acrylic	96 1/8" L 244cm L		Acrylic	\$460.00
	BYAP321F	6.5' Pole* Solid Acrylic	78 3/4" L 200cm L		Acrylic	\$386.00
	BYAP331F	8' Pole* Solid Acrylic	96 1/8" L 244cm L		Acrylic	\$576.00
	BYSP364F	4' Halo** Wood Pole	47 1/4" L 120cm L		Wood	\$196.00
	BYSP365F	5' Halo** Wood Pole	59" L 150cm L		Wood	\$236.00
	BYSP366F	6' Halo** Wood Pole	70 7/8" L 180cm L		Wood	\$272.00
	BYSP367F	7' Halo** Wood Pole	82 5/8" L 210cm L		Wood	\$316.00
	BYSP368F	8' Halo** Wood Pole	94 1/2" L 240cm L		Wood	\$400.00
	BYR3650F	Metal Ring	2 3/8" OD - 2" ID - 1/4" W 60mm OD - 50mm ID - 6mm W	2 5/8" 67mm	Metal	\$14.00
	BYR3651F	Metal Passing Ring	2 3/8" OD - 2" ID - 1/4" W 60mm OD - 50mm ID - 6mm W	2 5/8" 67mm	Metal	\$16.00
	BYR3652F	Acrylic Ring+	2 1/8" OD - 1 3/4" ID - 3/8" W 55mm OD - 45mm ID - 10mm W	2 1/2" 65mm	Acrylic	\$16.00









Review ACTUAL pole lengths in inches listed above before ordering.

\*\* Note: Actual pole lengths are not in full feet. Maximum length in wood is 94 1/2" - 240cm.

\* See page 60 for maximum drapery weights.

# HALO COLLECTION

## WASHED WOOD - 1 3/8" - 35 mm

1 3/8" - 35mm BRACKETS						
	Item Number	Item Name	Dimensions Inches / Metric	Projection	Material	Retail Price Each
	BYB3570F	Standard End	4 3/8" H x 1 1/8" Base x 5 1/2" L 110mm H x 30mm Base x 139mm L	4 1/2" 113mm	Metal	\$230.00
	BYB3571F	Standard Central	1 5/8" H x 3 1/2" Base x 5 1/2" L 40mm H x 88mm Base x 139mm L	4 1/2" 113mm	Metal	\$230.00
	BYB3572F	Adjustable Passing	2" H x 2" Base x 5 1/4" L 50mm H x 50mm Base x 133mm L	4 1/2" - 6 1/2" 114mm - 165mm	Metal	\$146.00
	BYB3573F	Central Joining	1 5/8" H x 3 1/2" Base x 5 1/2" L 40mm H x 88mm Base x 139mm L	4 1/2" 113mm	Metal	\$268.00
	BYB3574F	Extended End	4 3/8" H x 1 1/8" Base x 7 3/8" L 110mm H x 30mm Base x 186mm L	6 1/4" 160mm	Metal	\$268.00
	BYB3575F	Extended Central	1 5/8" H x 3 1/2" Base x 7 3/8" L 40mm H x 88mm Base x 186mm L	6 1/4" 160mm	Metal	\$268.00
	BYB3578F	Inside Mount Open	1 7/8" W x 1" L 47mm W x 26mm L	1/4" 6mm	Metal	\$116.00
	BYB3579F	Inside Mount Closed	1 7/8" W x 1" L 47mm W x 26mm L	1/4" 6mm	Metal	\$116.00
	BYB3580F	Extended Central Joining	1 5/8" H x 3 1/2" Base x 7 3/8" L 40mm H x 88mm Base x 186mm L	6 1/4" 160mm	Metal	\$306.00
	BYB3582F	Adjustable Extended Passing	2" H x 2" Base x 7 1/8" L 50mm H x 50mm Base x 180mm L	6 1/4" - 8 1/4" 160mm - 209mm	Metal	\$194.00

Bracket support recommended every 3 ft - 91.44cm for acrylic poles. Every 4 ft - 120cm for wood.

### HALO WASHED WOOD FINISHES

#### METAL END CAPS, BRACKETS & RINGS

Chrome 840    Burnished Brass 810    Copper 860

#### ACRYLIC RINGS, WAND & POLES

Clear Acrylic 990

#### FINIALS

Washed Limed Oak/Chrome 842    Washed English Oak/Chrome 843

(Washed Wood w/ Chrome) Washed Smoked Oak/Chrome 844    Washed Toasted Oak/Chrome 845

Washed Chateau Grey/Chrome 846

#### FINIALS

Washed Limed Oak/BB 812

Washed English Oak/BB 813

(Washed Wood w/ Burnished Brass)

Washed Smoked Oak/BB 814

Washed Toasted Oak/BB 815

Washed Chateau Grey/BB 816

#### FINIALS

Washed Limed Oak/Copper 862

Washed English Oak/Copper 863

(Washed Wood w/ Copper) Washed Smoked Oak/Copper 864    Washed Toasted Oak/Copper 865

Washed Chateau Grey/Copper 866

#### POLES

Washed Limed Oak 400

Washed English Oak 401

(Washed Wood)





Washed Smoked Oak 402

Washed Toasted Oak 403

Washed Chateau Grey 404

# HALO COLLECTION

## WASHED WOOD - 1 3/4" - 45 mm

1 3/4" - 45mm FINIALS & END CAPS					
Item Number	Item Name	Item Name	Dimensions Inches / Metric	Material	Retail Price Each
	BYF4520F	Stellar	3 1/4" H x 5" L 82mm H x 126mm L	Wood/Metal	\$312.00
	BYF4521F	Luna	3 1/4" H x 4" L 82mm H x 100mm L	Wood/Metal	\$290.00
	BYF4522F	Globus	3" H x 4 3/8" L 75mm H x 111mm L	Wood/Metal	\$264.00
	BYF4523F	Orion	3 1/4" H x 3 7/8" L 83mm H x 97mm L	Wood/Metal	\$300.00
	BYF4514F	End Cap	2 1/8" H x 1 1/8" L 53mm H x 29mm L	Metal	\$128.00

1 3/4" - 45mm POLES* & RINGS						
Item Number	Item Name	Item Name	Dimensions Inches / Metric	Top of Pole to Eyelet	Material	Retail Price Each
	BYHP420F	6.5' Pole* Hollow Acrylic	78 3/4" L 200cm L		Acrylic	\$504.00
	BYHP430F	8' Pole* Hollow Acrylic	96 1/8" L 244cm L		Acrylic	\$752.00
	BYAP421F	6.5' Pole* Solid Acrylic	78 3/4" L 200cm L		Acrylic	\$634.00
	BYAP431F	8' Pole* Solid Acrylic	96 1/8" L 244cm L		Acrylic	\$944.00
	BYSP464F	4' Halo Pole** Wood	47 1/4" L 120cm L		Wood	\$254.00
	BYSP465F	5' Halo Pole** Washed Wood	59" L 150cm L		Wood	\$318.00
	BYSP466F	6' Halo Pole** Wood	70 7/8" L 180cm L		Wood	\$364.00
	BYSP467F	7' Halo Pole** Wood	82 5/8" L 210cm L		Wood	\$426.00
	BYSP468F	8' Halo Pole** Wood	94 1/2" L 240cm L		Wood	\$514.00
	BYR4650F	Metal Ring	2 3/4" OD - 2 1/4" ID - 1/4" W 70mm OD - 60mm ID - 6mm W	3" 76mm	Metal	\$16.00
	BYR4651F	Metal Passing Ring	2 3/4" OD - 2 1/4" ID - 1/4" W 70mm OD - 60mm ID - 6mm W	3" 76mm	Metal	\$16.00
	BYR4652F	Acrylic Ring*	2 1/2" OD - 2 1/4" ID - 3/8" W 65mm OD - 55mm ID - 10mm W	3" 76mm	Acrylic	\$20.00

Review ACTUAL pole lengths in inches listed above before ordering.





\*\* Note: Actual pole lengths are not in full feet. Maximum length in wood is 94 1/2" - 240cm.

\* See page 60 for maximum drapery weights.



# HALO COLLECTION

## WASHED WOOD - 1 3/4" - 45 mm

1 3/4" - 45mm BRACKETS						
Item Number	Item Name	Dimensions Inches / Metric	Projection	Material	Retail Price Each	
 BYB4570F	Standard End	4 3/8" H x 1 1/8" Base x 5 5/8" L 110mm H x 30mm Base x 144mm L	4 1/2" 113mm	Metal	\$256.00	
 BYB4571F	Standard Central	1 5/8" H x 3 1/2" Base x 5 5/8" L 40mm H x 88mm Base x 144mm L	4 1/2" 113mm	Metal	\$256.00	
 BYB4572F	Adjustable Passing	2" H x 2" Base x 5 1/4" L 50mm H x 50mm Base x 134mm L	4 1/2" - 6 1/2" 114mm - 165mm	Metal	\$162.00	
 BYB4573F	Central Joining	1 5/8" H x 3 1/2" Base x 5 5/8" L 40mm H x 88mm Base x 144mm L	4 1/2" 113mm	Metal	\$296.00	
 BYB4574F	Extended End	4 3/8" H x 1 1/8" Base x 7 1/2" L 110mm H x 30mm Base x 191mm L	6 1/4" 160mm	Metal	\$296.00	
 BYB4575F	Extended Central	1 5/8" H x 3 1/2" Base x 7 1/2" L 40mm H x 88mm Base x 191mm L	6 1/4" 160mm	Metal	\$296.00	
 BYB4576F	Double End (35mm/45mm)	4 3/8" H x 1 1/8" Base x 10" L 110mm H x 30mm Base x 254mm L	5 5/8" - 143 mm (BP) 8 3/4" - 223mm (FP)	Metal	\$336.00	
 BYB4577F	Double Central (35mm/45mm)	1 5/8" H x 3 1/2" Base x 10" L 40mm H x 88mm Base x 254mm L	5 5/8" - 143 mm (BP) 8 3/4" - 223mm (FP)	Metal	\$336.00	
 BYB4578F	Inside Mount Open	2 1/4" Base x 1 1/8" L 58mm Base x 29mm L	1/4" 6mm	Metal	\$128.00	
 BYB4579F	Inside Mount Closed	2 1/4" Base x 1 1/8" L 58mm Base x 29mm L	1/4" 6mm	Metal	\$128.00	
 BYB4580F	Extended Central Joining	1 5/8" H x 3 1/2" Base x 7 1/2" L 40mm H x 88mm Base x 191mm L	6 1/4" 160mm	Metal	\$340.00	
 BYB4581F	Ext. Central Double Joining (35mm/45mm)	1 5/8" H x 3 1/2" Base x 10" L 40mm H x 88mm Base x 254mm L	5 5/8" - 143 mm (BP) 8 3/4" - 223mm (FP)	Metal	\$384.00	
 BYB4582F	Adjustable Extended Passing	2" H x 2" Base x 7 1/4" L 50mm H x 50mm Base x 184mm L	6 1/4" - 8 1/4" 160mm - 209mm	Metal	\$210.00	

Bracket support recommended every 3 ft - 91.44cm for acrylic poles. Every 4 ft - 120cm for wood.

### HALO WASHED WOOD FINISHES

#### METAL END CAPS, BRACKETS & RINGS

Chrome 840    Burnished Brass 810    Copper 860

#### ACRYLIC RINGS, WAND & POLES

Clear Acrylic 990

#### FINIALS

Washed Limed Oak/Chrome 842    Washed English Oak/Chrome 843

(Washed Wood w/ Chrome) Washed Smoked Oak/Chrome 844    Washed Toasted Oak/Chrome 845

Washed Chateau Grey/Chrome 846

#### FINIALS

Washed Limed Oak/BB 812    Washed English Oak/BB 813

(Washed Wood w/ Burnished Brass)

Washed Smoked Oak/BB 814    Washed Toasted Oak/BB 815

Washed Chateau Grey/BB 816

#### FINIALS

Washed Limed Oak/Copper 862    Washed English Oak/Copper 863

(Washed Wood w/ Copper) Washed Smoked Oak/Copper 864    Washed Toasted Oak/Copper 865

Washed Chateau Grey/Copper 866

#### POLES

Washed Limed Oak 400    Washed English Oak 401

(Washed Wood)

Washed Smoked Oak 402    Washed Toasted Oak 403

Washed Chateau Grey 404

# HALO COLLECTION

## WASHED WOOD - 2 1/8" - 55 mm

2 1/8" - 55mm FINIALS & END CAPS					
Item Number	Item Name	Item Name	Dimensions Inches / Metric	Material	Retail Price Each
 BYF5520F	Stellar		3 1/2" H x 5 1/2" L 89mm H x 138mm L	Wood/Metal	\$418.00
 BYF5521F	Luna		3 5/8" H x 4 5/8" L 93mm H x 118mm L	Wood/Metal	\$378.00
 BYF5522F	Globus		3 1/2" H x 5 3/8" L 90mm H x 135mm L	Wood/Metal	\$366.00
 BYF5523F	Orion		4 1/2" W x 5" L 113mm H x 128mm L	Wood/Metal	\$454.00
 BYF5514F	End Cap		2 1/2" H x 1 3/8" L 63mm H x 34mm L	Metal	\$140.00

2 1/8" - 55mm POLES* & RINGS						
Item Number	Item Name	Item Name	Dimensions Inches / Metric	Top of Pole to Eyelet	Material	Retail Price Each
 BYHP520F	6.5' Pole* Hollow Acrylic		78 3/4" L 200cm L		Acrylic	\$678.00
 BYHP530F	8' Pole* Hollow Acrylic		96 1/8" L 244cm L		Acrylic	\$1016.00
 BYAP521F	6.5' Pole* Solid Acrylic		78 3/4" L 200cm L		Acrylic	\$848.00
 BYAP531F	8' Pole* Solid Acrylic		96 1/8" L 244cm L		Acrylic	\$1272.00
 BYSP565F	5' Halo Pole** Washed Wood		59" L 150cm L		Wood	\$434.00
 BYSP566F	6' Halo Pole** Washed Wood		70 7/8" L 180cm L		Wood	\$514.00
 BYSP567F	7' Halo Pole** Washed Wood		82 5/8" L 210cm L		Wood	\$602.00
 BYSP568F	8' Halo Pole** Washed Wood		94 1/2" L 240cm L		Wood	\$654.00
 BYR5650F	Metal Ring		3 1/8" OD - 2 3/4" ID - 1/4" W 80mm OD - 70mm ID - 8mm	3 3/8" 85mm	Metal	\$22.00
 BYR5651F	Metal Passing Ring		3 1/8" OD - 2 3/4" ID - 1/4" W 80mm OD - 70mm ID - 8mm W	3 3/8" 85mm	Metal	\$26.00
 BYR5652F	Acrylic Ring*		3" OD - 2 5/9" ID - 1/2" W 75mm OD - 65mm ID - 12mm W	3 3/8" 85mm	Acrylic	\$28.00

\*Review ACTUAL pole lengths in inches listed above before ordering.

\*\* Note: Actual pole lengths are not in full feet. Maximum length in wood is 94 1/2" - 240cm.

\* See page 60 for maximum drapery weights.

# HALO COLLECTION

## WASHED WOOD - 2 1/8" - 55 mm

2 1/8" - 55mm BRACKETS						
	Item Number	Item Name	Dimensions Inches / Metric	Projection	Material	Retail Price Each
	BYB5570F	Standard End	4 7/8" H x 1 1/8" Base x 6 1/4" L 125mm H x 30mm Base x 160mm L	4 7/8" 123mm	Metal	\$280.00
	BYB5571F	Standard Central	2" H x 4 3/8" Base x 6 1/4" L 50mm H x 110mm Base x 160mm L	4 7/8" 123mm	Metal	\$280.00
	BYB5572F	Adjustable Passing	2 1/8" H x 2 1/8" Base x 6" L 55mm H x 55mm Base x 152mm L	4 7/8" - 6 7/8" 123mm - 174mm	Metal	\$176.00
	BYB5573F	Central Joining	2" H x 4 3/8" Base x 6 1/4" L 50mm H x 110mm Base x 160mm L	4 7/8" 123mm	Metal	\$320.00
	BYB5574F	Extended End	4 7/8" H x 1 1/8" Base x 7 3/4" L 125mm H x 30mm Base x 196mm L	6 1/4" 160mm	Metal	\$320.00
	BYB5575F	Extended Central	2" H x 4 3/8" Base x 7 3/4" L 50mm H x 110mm Base x 196mm L	6 1/4" 160mm	Metal	\$320.00
	BYB5578F	Inside Mount Open	2 3/4" Base x 1 3/8" L 69mm Base x 34mm L	1/4" 6mm	Metal	\$146.00
	BYB5579F	Inside Mount Closed	2 3/4" Base x 1 3/8" L 69mm Base x 34mm L	1/4" 160mm	Metal	\$146.00
	BYB5580F	Extended Central Joining	2" H x 4 3/8" Base x 7 3/4" L 50mm H x 110mm Base x 196mm L	6 1/4" 160mm	Metal	\$368.00
	BYB5582F	Adjustable Extended Passing	2 1/8" H x 2 1/8" Base x 7 1/2" L 55mm H x 55mm Base x 190mm L	6 1/4" - 8 1/4" 160mm - 209mm	Metal	\$228.00





Bracket support recommended every 3 ft - 91.44cm for acrylic poles. Every 4 ft - 120cm for wood.

### HALO WASHED WOOD FINISHES

METAL END CAPS, BRACKETS & RINGS	Chrome 840	Burnished Brass 810	Copper 860
ACRYLIC RINGS, WAND & POLES	Clear Acrylic 990		
FINIALS & POLES	Washed Limed Oak/Chrome 842	Washed English Oak/Chrome 843	
(Washed Wood w/ Chrome)	Washed Smoked Oak/Chrome 844	Washed Toasted Oak/Chrome 845	
	Washed Chateau Grey/Chrome 846		
FINIALS & POLES	Washed Limed Oak/BB 862	Washed English Oak/BB 813	
(Washed Wood w/ Burnished Brass)	Washed Smoked Oak/BB 814	Washed Toasted Oak/BB 815	
	Washed Chateau Grey/BB 816		
FINIALS & POLES	Washed Limed Oak/Copper 861	Washed English Oak/Copper 863	
(Washed Wood w/ Copper)	Washed Smoked Oak/Copper 864	Washed Toasted Oak/Copper 865	
	Washed Chateau Grey/Copper 866		
POLES	Washed Limed Oak 400	Washed English Oak 401	
(Washed Wood)	Washed Smoked Oak 402	Washed Toasted Oak 403	
	Washed Chateau Grey 404		

# HALO COLLECTION

## GLOSS - 1 3/8" - 35 mm

1 3/8" - 35mm FINIALS & END CAPS					
Item Number	Item Name	Dimensions Inches / Metric	Material	Retail Price Each	
 BYF3530F	Stellar	2 3/4" H x 4 1/2" L 70mm W x 114mm L	Wood/Metal	\$234.00	
 BYF3531F	Luna	3" H x 3 3/8" L 76mm W x 85mm L	Wood/Metal	\$172.00	
 BYF3532F	Globus	2 5/8" H x 3 7/8" L 68mm W x 100mm L	Wood/Metal	\$160.00	
 BYF3533F	Orion	2 7/8" H x 2 7/8" L 74mm W x 72mm L	Wood/Metal	\$202.00	
 BYF3514F	End Cap	1 3/4" H x 1" L 43mm W x 25mm L	Metal	\$116.00	

1 3/8" - 35mm POLES* & RINGS					
Item Number	Item Name	Dimensions Inches / Metric	Top of Pole to Eyelet	Material	Retail Price Each
 BYHP320F	6.5' Pole* Hollow Acrylic	78 3/4" L 200cm L		Acrylic	\$328.00
 BYHP330F	8' Pole* Hollow Acrylic	96 1/8" L 244cm L		Acrylic	\$460.00
 BYAP321F	6.5' Pole* Solid Acrylic	78 3/4" L 200cm L		Acrylic	\$386.00
 BYAP331F	8' Pole* Solid Acrylic	96 1/8" L 244cm L		Acrylic	\$576.00
 BYSP374F	4' Halo Pole** Gloss	47 1/4" L 120cm L		Wood	\$174.00
 BYSP375F	5' Halo Pole** Gloss	59" L 150cm L		Wood	\$192.00
 BYSP376F	6' Halo Pole** Gloss	70 7/8" L 180cm L		Wood	\$222.00
 BYSP377F	7' Halo Pole** Gloss	82 5/8" L 210cm L		Wood	\$268.00
 BYSP378F	8' Halo Pole** Gloss	94 1/2" L 240cm L		Wood	\$324.00
 BYR3650F	Metal Ring	2 3/8" OD - 2" ID - 1/4" W 60mm OD - 50mm ID - 6mm W	2 5/8" 67mm	Metal	\$14.00
 BYR3651F	Metal Passing Ring	2 3/8" OD - 2" ID - 1/4" W 60mm OD - 50mm ID - 6mm W	2 5/8" 67mm	Metal	\$16.00
 BYR3652F	Acrylic Ring*	2 1/8" OD - 1 3/4" ID - 3/8" W 55mm OD - 45mm ID - 10mm W	2 1/2" 65mm	Acrylic	\$16.00











Review ACTUAL pole lengths in inches listed above before ordering.

\*\* Note: Actual pole lengths are not in full feet. Maximum length in wood is 94 1/2" - 240cm.

\* See page 60 for maximum drapery weights.

# HALO COLLECTION

## GLOSS - 1 3/8" - 35 mm

1 3/8" - 35mm BRACKETS						
	Item Number	Item Name	Dimensions Inches / Metric	Projection	Material	Retail Price Each
	BYB3570F	Standard End	4 3/8" H x 1 1/8" Base x 5 1/2" L 110mm H x 30mm Base x 139mm L	4 1/2" 113mm	Metal	\$230.00
	BYB3571F	Standard Central	1 5/8" H x 3 1/2" Base x 5 1/2" L 40mm H x 88mm Base x 139mm L	4 1/2" 113mm	Metal	\$230.00
	BYB3572F	Adjustable Passing	2" H x 2" Base x 5 1/8" L 50mm H x 50mm Base x 133mm L	4 1/2" - 6 1/2" 110mm - 165mm	Metal	\$146.00
	BYB3573F	Central Joining	1 5/8" H x 3 1/2" Base x 5 1/2" L 40mm H x 88mm Base x 139mm L	4 1/2" 113mm	Metal	\$268.00
	BYB3574F	Extended End	4 3/8" H x 1 1/8" Base x 7 3/8" L 110mm H x 30mm Base x 186mm L	6 1/4" 160mm	Metal	\$268.00
	BYB3575F	Extended Central	1 5/8" H x 3 1/2" Base x 7 3/8" L 40mm H x 88mm Base x 186mm L	6 1/4" 160mm	Metal	\$268.00
	BYB3578F	Inside Mount Open	1 7/8" Base x 1" L 47mm Base x 26mm L	1/4" 160mm	Metal	\$116.00
	BYB3579F	Inside Mount Closed	1 7/8" Base x 1" L 47mm Base x 26mm L	1/4" 160mm	Metal	\$116.00
	BYB3580F	Extended Central Joining	1 5/8" H x 3 1/2" Base x 7 3/8" L 40mm H x 88mm Base x 186mm L	6 1/4" 160mm	Metal	\$306.00
	BYB3582F	Adjustable Extended Passing	2" H x 2" Base x 7 1/8" L 50mm H x 50mm Base x 180mm L	6 1/4" - 8 1/4" 160mm - 209mm	Metal	\$194.00

Bracket support recommended every 3 ft - 91.44cm for acrylic poles. Every 4 ft - 120cm for wood.

### HALO GLOSS FINISHES

METAL END CAPS, BRACKETS & RINGS      Chrome 840    Burnished Brass 810    Copper 860

ACRYLIC RINGS, WAND & POLES      Clear Acrylic 990

FINIALS (Gloss w/ Chrome)	Snow/Chrome 847	Citrus/Chrome 851	Spring/Chrome 855
	Ash/Chrome 848	Bittersweet/Chrome 852	Artichoke/Chrome 856
	Smoke/Chrome 849	Lipstick/Chrome 853	Azure/Chrome 857
	Mink/Chrome 850	Magenta/Chrome 854	Midnight/Chrome 858





FINIALS (Gloss w/ Burnished Brass)	Ash/BB 818	Snow/BB 817	Citrus/BB 821	Spring/BB 825
		Bittersweet/BB 822	Artichoke/BB 826	
		Smoke/BB 819	Lipstick/BB 823	Azure/BB 827
		Mink/BB 820	Magenta/BB 824	Midnight/BB 828

FINIALS (Gloss w/ Copper)	Snow/Copper 867	Citrus/Copper 871	Spring/Copper 875
	Ash/Copper 868	Bittersweet/Copper 872	Artichoke/Copper 876
	Smoke/Copper 869	Lipstick/Copper 873	Azure/Copper 877
	Mink/Copper 870	Magenta/Copper 874	Midnight/Copper 878

POLES (Gloss)	Snow 405	Citrus 409	Spring 413
	Ash 406	Bittersweet 410	Artichoke 414
	Smoke 407	Lipstick 411	Azure 415
	Mink 408	Magenta 412	Midnight 416

# HALO COLLECTION

## GLOSS - 1 3/4" - 45 mm

1 3/4" - 45mm FINIALS & END CAPS					
Item Number	Item Name	Dimensions Inches / Metric	Material	Retail Price Each	
 BYF4530F	Stellar	3 1/4" H x 5" L 82mm H x 126mm L	Wood/Metal	\$256.00	
 BYF4531F	Luna	3 1/4" H x 4" L 82mm H x 100mm L	Wood/Metal	\$246.00	
 BYF4532F	Globus	3" H x 4 3/8" L 75mm H x 111mm L	Wood/Metal	\$234.00	
 BYF4533F	Orion	3 1/4" H x 3 7/8" L 83mm H x 97mm L	Wood/Metal	\$256.00	
 BYF4514F	End Cap	2 1/8" H x 1 1/8" L 53mm H x 29mm L	Metal	\$128.00	

1 3/4" - 45mm POLES* & RINGS					
Item Number	Item Name	Dimensions Inches / Metric	Top of Pole to Eyelet	Material	Retail Price Each
 BYHP420F	6.5' Pole* Hollow Acrylic	78 3/4" L 200cm L		Acrylic	\$504.00
 BYHP430F	8' Pole* Hollow Acrylic	96 1/8" L 244cm L		Acrylic	\$752.00
 BYAP421F	6.5' Pole* Solid Acrylic	78 3/4" L 200cm L		Acrylic	\$634.00
 BYAP431F	8' Pole* Solid Acrylic	96 1/8" L 244cm L		Acrylic	\$944.00
 BYSP474F	4' Halo Pole** Gloss	47 1/4" L 120cm L		Wood	\$222.00
 BYSP475F	5' Halo Pole** Gloss	59" L 150cm L		Wood	\$260.00
 BYSP476F	6' Halo Pole** Gloss	70 7/8" L 180cm L		Wood	\$298.00
 BYSP477F	7' Halo Pole** Gloss	82 5/8" L 210cm L		Wood	\$372.00
 BYSP478F	8' Halo Pole** Gloss	94 1/2" L 240cm L		Wood	\$420.00
 BYR4650F	Metal Ring	2 3/4" OD - 2 1/4" ID - 1/4" W 70mm OD - 60mm ID - 6mm W	3" 76mm	Metal	\$16.00
 BYR4651F	Metal Passing Ring	2 3/4" OD - 2 1/4" ID - 1/4" W 70mm OD - 60mm ID - 6mm W	3" 76mm	Metal	\$16.00
 BYR4652F	Acrylic Ring*	2 1/2" OD - 2 1/4" ID - 3/8" W 65mm OD - 55mm ID - 10mm W	3" 76mm	Acrylic	\$20.00



Review ACTUAL pole lengths in inches listed above before ordering.

\*\* Note: Actual pole lengths are not in full feet. Maximum length in wood is 94 1/2" - 240cm.

\* See page 60 for maximum drapery weights.

# HALO COLLECTION

## GLOSS - 1 3/4" - 45 mm

1 3/4" - 45mm BRACKETS						
	Item Number	Item Name	Dimensions Inches / Metric	Projection	Material	Retail Price Each
	BYB4570F	Standard End	4 3/8" H x 1 1/8" Base x 5 5/8" L 110mm H x 30mm Base x 144mm L	4 1/2" 113mm	Metal	\$256.00
	BYB4571F	Standard Central	1 5/8" H x 3 1/2" Base x 5 5/8" L 40mm H x 88mm Base x 144mm L	4 1/2" 113mm	Metal	\$256.00
	BYB4572F	Adjustable Passing	2" H x 2" Base x 5 1/4" L 50mm H x 50mm Base x 134mm L	4 1/2" - 6 1/2" 114mm - 165mm	Metal	\$162.00
	BYB4573F	Central Joining	1 5/8" H x 3 1/2" Base x 5 5/8" L 40mm H x 88mm Base x 144mm L	4 1/2" 113mm	Metal	\$296.00
	BYB4574F	Extended End	4 3/8" H x 1 1/8" Base x 7 1/2" L 110mm H x 30mm Base x 191mm L	6 1/4" 160mm	Metal	\$296.00
	BYB4575F	Extended Central	1 5/8" H x 3 1/2" Base x 7 1/2" L 40mm H x 88mm Base x 191mm L	6 1/4" 160mm	Metal	\$296.00
	BYB4576F	Double End (35mm/45mm)	4 3/8" H x 1 1/8" Base x 10" L 110mm H x 30mm Base x 254mm L	5 5/8" - 143mm (BP) 8 3/4" - 223 mm (FP)	Metal	\$336.00
	BYB4577F	Double Central (35mm/45mm)	1 5/8" H x 3 1/2" Base x 10" L 40mm H x 88mm Base x 254mm L	5 5/8" - 143mm (BP) 8 3/4" - 223 mm (FP)	Metal	\$336.00
	BYB4578F	Inside Mount Open	2 1/4" Base x 1 1/8" L 58mm Base x 29mm L	1/4" 6mm	Metal	\$128.00
	BYB4579F	Inside Mount Closed	2 1/4" Base x 1 1/8" L 58mm Base x 29mm L	1/4" 6mm	Metal	\$128.00
	BYB4580F	Extended Central Joining	1 5/8" H x 3 1/2" Base x 7 1/2" L 40mm H x 88mm Base x 191mm L	6 1/4" 160mm	Metal	\$340.00
	BYB4581F	Ext. Central Double Joining (35mm/45mm)	1 5/8" H x 3 1/2" Base x 10" L 40mm H x 88mm Base x 254mm L	5 5/8" - 143mm (BP) 8 3/4" - 223mm (FP)	Metal	\$384.00
	BYB4582F	Adjustable Extended Passing	2" H x 2" Base x 7 1/4" L 50mm H x 50mm Base x 184mm L	6 1/4" - 8 1/4" 160mm - 209 mm	Metal	\$210.00

Bracket support recommended every 3 ft - 91.44cm for acrylic poles. Every 4 ft - 120cm for wood.

### HALO GLOSS FINISHES

METAL END CAPS, BRACKETS & RINGS      Chrome 840    Burnished Brass 810    Copper 860

ACRYLIC RINGS, WAND & POLES      Clear Acrylic 990

FINIALS (Gloss w/ Chrome)	Snow/Chrome 847 Ash/Chrome 848 Smoke/Chrome 849 Mink/Chrome 850	Citrus/Chrome 851 Bittersweet/Chrome 852 Lipstick/Chrome 853 Magenta/Chrome 854	Spring/Chrome 855 Artichoke/Chrome 856 Azure/Chrome 857 Midnight/Chrome 858
------------------------------	--	--	--

FINIALS (Gloss w/ Burnished Brass)	Ash/BB 818	Snow/BB 817 Bittersweet/BB 822 Smoke/BB 819 Mink/BB 820	Citrus/BB 821 Artichoke/BB 826 Lipstick/BB 823 Magenta/BB 824	Spring/BB 825  Azure/BB 827 Midnight/BB 828
---------------------------------------	------------	--	--	--

FINIALS (Gloss w/ Copper)	Snow/Copper 867 Ash/Copper 868 Smoke/Copper 869 Mink/Copper 870	Citrus/Copper 871 Bittersweet/Copper 872 Lipstick/Copper 873 Magenta/Copper 874	Spring/Copper 875 Artichoke/Copper 876 Azure/Copper 877 Midnight/Copper 878
------------------------------	--	--	--





POLES (Gloss)	Snow 405 Ash 406 Smoke 407 Mink 408	Citrus 409 Bittersweet 410 Lipstick 411 Magenta 412	Spring 413 Artichoke 414 Azure 415 Midnight 416
------------------	--	--	--













## HALO COLLECTION

### GLOSS - 2 1/8" - 55 mm

#### 2 1/8" - 55mm FINIALS & END CAPS

Item Number	Item Name	Dimensions Inches / Metric	Material	Retail Price Each
 BYF5530F	Stellar	3 1/2" H x 5 1/2" L 123mm W x 138mm L	Wood/Metal	\$352.00
 BYF5531F	Luna	3 5/8" H x 4 5/8" L 93mm W x 118mm L	Wood/Metal	\$342.00
 BYF5532F	Globus	3 1/2" H x 5 3/8" L 90mm W x 135mm L	Wood/Metal	\$328.00
 BYF5533F	Orion	4 1/2" H x 5" L 113mm W x 128mm L	Wood/Metal	\$404.00
 BYF5514F	End Cap	2 1/2" H x 1 3/8" L 63mm W x 34mm L	Metal	\$140.00

#### 2 1/8" - 55mm POLES\* & RINGS

Item Number	Item Name	Dimensions Inches / Metric	Top of Pole to Eyelet	Material	Retail Price Each
 BYHP520F	6.5' Pole* Hollow Acrylic	78 3/4" L 200cm L		Acrylic	\$678.00
 BYHP530F	8' Pole* Hollow Acrylic	96 1/8" L 244cm L		Acrylic	\$1016.00
 BYAP521F	6.5' Pole* Solid Acrylic	78 3/4" L 200cm L		Acrylic	\$848.00
 BYAP531F	8' Pole* Solid Acrylic	96 1/8" L 244cm L		Acrylic	\$1272.00
 BYSP575F	5' Halo Pole** Gloss	59" L 150cm L		Wood	\$354.00
 BYSP576F	6' Halo Pole** Gloss	70 7/8" L 180cm L		Wood	\$410.00
 BYSP577F	7' Halo Pole** Gloss	82 5/8" L 210cm L		Wood	\$488.00
 BYSP578F	8' Halo Pole** Gloss	94 1/2" L 240cm L		Wood	\$536.00
 BYR5650F	Metal Ring	3 1/8" OD - 2 3/4" ID - 1/4" W 80mm OD - 70mm ID - 8mm	3 3/8" 85mm	Metal	\$22.00
 BYR5651F	Metal Passing Ring	3 1/8" OD - 2 3/4" ID - 1/4" W 80mm OD - 70mm ID - 8mm W	3 3/8" 85mm	Metal	\$26.00
 BYR5652F	Acrylic Ring*	3" OD - 2 1/8" ID - 1/4" W 75mm OD - 65mm ID - 8mm W	3 3/8" 85mm	Acrylic	\$28.00

Review ACTUAL pole lengths in inches listed above before ordering.











\*\* Note: Actual pole lengths are not in full feet. Maximum length in wood is 94 1/2" - 240cm.

\* See page 60 for maximum drapery weights.





# HALO COLLECTION GLOSS - 2 1/8" - 55 mm

## 2 1/8" - 55mm - BRACKETS

Item Number	Item Name	Dimensions Inches / Metric	Projection	Material	Retail Price Each
 BYB5570F	Standard End	4 7/8" H x 1 1/8" Base x 6 1/4" L 125mm H x 30mm Base x 160mm L	4 7/8" 123mm	Metal	\$280.00
 BYB5571F	Standard Central	2" H x 4 3/8" Base x 6 1/4" L 50mm H x 110mm Base x 160mm L	4 7/8" 123mm	Metal	\$280.00
 BYB5572F	Adjustable Passing	2 1/8" H x 2 1/8" Base x 6" L 55mm H x 55mm Base x 152mm L	4 7/8" - 6 7/8" 123mm - 174mm	Metal	\$176.00
 BYB5573F	Central Joining	2" H x 4 3/8" Base x 6 1/4" L 50mm H x 110mm Base x 160mm L	4 7/8" 123mm	Metal	\$320.00
 BYB5574F	Extended End	4 7/8" H x 1 1/8" Base x 7 3/4" L 125mm H x 30mm Base x 196mm L	6 1/4" 160mm	Metal	\$320.00
 BYB5575F	Extended Central	2" H x 4 3/8" Base x 7 3/4" L 50mm H x 110mm Base x 196mm L	6 1/4" 160mm	Metal	\$320.00
 BYB5578F	Inside Mount Open	2 3/4" Base x 1 3/8" L 69mm Base x 34mm L	1/4" 6mm	Metal	\$146.00
 BYB5579F	Inside Mount Closed	2 3/4" Base x 1 3/8" L 69mm Base x 34mm L	1/4" 6mm	Metal	\$146.00
 BYB5580F	Extended Central Joining	2" H x 4 3/8" Base x 7 3/4" L 50mm H x 110mm Base x 196mm L	6 1/4" 160mm	Metal	\$368.00
 BYB5582F	Adjustable Extended Passing	2 1/8" H x 2 1/8" Base x 7 1/2" L 55mm H x 55mm Base x 190mm L	6 1/4" - 8 1/4" 160mm - 209mm	Metal	\$228.00

Bracket support recommended every 3 ft - 91.44cm for acrylic poles. Every 4 ft - 120cm for wood.

## WANDS







Item Number	Item Name	Dimensions Inches / Metric	Material	Retail Price Each
 BYU6036F	WAND	36" L 92cm L	Acrylic	\$48.00
 BYU6048F	WAND	48" L 122cm L	Acrylic	\$54.00







### HALO GLOSS FINISHES

METAL END CAPS, BRACKETS & RINGS	Chrome 840	Burnished Brass 810	Copper 860
ACRYLIC RINGS, WAND & POLES	Clear Acrylic 990		
FINIALS (Gloss w/ Chrome)	Snow/Chrome 847 Ash/Chrome 848 Smoke/Chrome 849 Mink/Chrome 850	Citrus/Chrome 851 Bittersweet/Chrome 852 Lipstick/Chrome 853 Magenta/Chrome 854	Spring/Chrome 855 Artichoke/Chrome 856 Azure/Chrome 857 Midnight/Chrome 858
FINIALS (Gloss w/ Burnished Brass)	Ash/BB 818 Snow/BB 817 Bittersweet/BB 822 Smoke/BB 819 Mink/BB 820	Citrus/BB 821 Artichoke/BB 826 Lipstick/BB 823 Magenta/BB 824	Spring/BB 825 Azure/BB 827 Midnight/BB 828
FINIALS (Gloss w/ Copper)	Snow/Copper 867 Ash/Copper 868 Smoke/Copper 869 Mink/Copper 870	Citrus/Copper 871 Bittersweet/Copper 872 Lipstick/Copper 873 Magenta/Copper 874	Spring/Copper 875 Artichoke/Copper 876 Azure/Copper 877 Midnight/Copper 878
POLES (Gloss)	Snow 405 Ash 406 Smoke 407 Mink 408	Citrus 409 Bittersweet 410 Lipstick 411 Magenta 412	Spring 413 Artichoke 414 Azure 415 Midnight 416

# BARNWOOD COLLECTION

1 3/8" - 35 mm

1 3/8" - 35mm FINIALS & END CAPS					
Item Number	Item Name	Dimensions Inches / Metric	Material	Retail Price Each	
 BYF3000F	End Cap	1 3/4" H x 1 1/8" L 46mm H x 28mm L	Wood	\$42.00	
 BYF3001F	Carbis	2 7/8" H x 4" L 73mm H x 101mm L	Wood	\$78.00	
 BYF3002F	Lamorna	2 7/8" H x 3 1/8" L 72mm H x 78mm L	Wood	\$78.00	
 BYF3003F	Austell	2 7/8" H x 3 1/8" L 73mm H x 79mm L	Wood	\$78.00	
 BYF3004F	Ives	2 3/4" H x 3 5/8" L 71mm H x 91mm L	Wood	\$78.00	
 BYF3005F	Saltash	2 7/8" H x 3 7/8" L 73mm H x 100mm L	Wood	\$78.00	

1 3/8" - 35mm POLES & RINGS						
Item Number	Item Name	Dimensions Inches / Metric	Top of Pole to Eyelet	Material	Retail Price Each	
 BYSP304F	4' Pole*	47 1/4" L 120cm L		Wood	\$140.00	
 BYSP305F	5' Pole*	59" L 150cm L		Wood	\$174.00	
 BYSP306F	6' Pole*	70 7/8" L 180cm L		Wood	\$202.00	
 BYSP307F	7' Pole*	82 5/8" L 210cm L		Wood	\$270.00	
 BYSP308F	8' Pole*	94 1/2" L 240cm L		Wood	\$304.00	
 BYR3600F	Ring	2 1/2" OD - 1 3/4" ID 65mm OD - 45mm ID	2 3/4" 70mm	Wood	\$10.00	













\* Advise when splicing poles for longer lengths. Center support brackets required.  
Review ACTUAL pole lengths in inches listed above before ordering.

## BARNWOOD FINISHES

Calico 906      Natural Stone 914      Barnwood Cream 915      Barnwood White 916  
Dove Grey 940      Barnwood Grey 943      Moss Green 981      Barnwood Green 916

# BARNWOOD COLLECTION

1 3/8" - 35 mm

1 3/8" - 35mm BRACKETS						
Item Number	Item Name	Dimensions Inches / Metric	Projection	Material	Retail Price Each	
 BYB3500F	Cup Bracket	2 3/8" Base x 5 3/8" L 61mm Base x 138mm L	4 1/8" 104mm	Wood	\$48.00	
 BYB3501F	Extended Cup Bracket	2 1/2" Base x 8 5/8" L 63mm Base x 219mm L	7 1/8" 182mm	Wood	\$68.00	
 BYB3502F	Double Cup Bracket (35mm/35mm)	2 3/8" Base x 9 5/8" L 60mm Base x 244mm L L	4 3/4" - 122mm (BP) 8 1/4" - 209mm (FP)	Wood	\$88.00	
 BYB3503F	Inside Mount Bracket	2 1/2" Base x 1 5/8" L 63mm Base x 42mm L	1/4" 6mm	Wood	\$38.00	
 BYB3504F	Double Architrave Bracket (35mm/35mm)	5 7/8" H x 1" Base x 8 7/8" L 150mm H x 26mm Base x 224mm	3 5/8" - 91mm (BP) 7 1/2" - 191mm (FP)	Wood	\$114.00	
 BYB3505F	Closed/Ceiling Bracket	2 1/8" Base x 5 1/2" L 54mm Base x 140mm L	4 1/8" 106mm	Wood	\$50.00	
 BYB3507F	Decorative Architrave Bracket	5 3/4" H x 1" Base x 6" L 146mm H x 26mm Base x 152mm	3 3/8" 85mm	Wood	\$88.00	
 BYB3508F	Architrave Bracket	6 3/4" H x 1" Base x 5 1/2" L 170mm H x 26mm Base x 139mm L	4 1/8" 105mm	Wood	\$78.00	
 BYB3509F	Ext. Architrave Bracket	5 7/8" H x 1" Base x 8 3/4" L 150mm H x 26mm Base x 222mm L	7 3/8" 187mm	Wood	\$114.00	
 BYB3550F	Invisible Bracket*	3 1/4" H x 1 5/8" Base x 6" L 82mm H x 40mm Base x 152mm L	5 1/2" 140mm	Metal	\$106.00	
 BYB3551F	Metal Center Bracket	1 3/8" H x 2 3/8" Base x 3 5/8" L 35mm H x 60mm Base x 91mm L	2 1/4" 56mm	Metal **	\$126.00	
 BYB3552F	Metal End Bracket	5 3/8" H x 1/2" Base x 3 5/8" L 136mm H x 14mm Base x 91mm L	2 1/4" 56mm	Metal **	\$126.00	
 BYB3560F	Elbow Bracket	1 3/4" Base x 3 3/8" L 45mm Base x 85mm L		Wood	\$94.00	

Review ACTUAL pole lengths in inches listed above before ordering.

\*Invisible bracket ONLY available in finish 830 Antique Brass.

Note: Advise when splicing poles for longer lengths. Center support brackets required

## BARNWOOD FINISHES

Calico 906

Natural Stone 914

Barnwood Cream 915

Barnwood White 916

Dove Grey 940

Barnwood Grey 943

Moss Green 981







Barnwood Green 916

\*\* METAL FINISHES: Brass 820 Antique Brass 830 Chrome 840







# BARNWOOD COLLECTION

1 3/4" - 45 mm

## 1 3/4" - 45mm FINIALS & END CAPS

Item Number	Item Name	Dimensions Inches / Metric	Material	Retail Price Each
 BYF4000F	End Cap	2 3/8" H x 1 1/8" L 59mm H x 29mm L	Wood	\$44.00
 BYF4001F	Carbis	3 1/3" H x 4 3/4" L 84mm H x 121mm L	Wood	\$92.00
 BYF4002F	Lamorna	3 1/8" H x 3 1/4" L 80mm H x 83mm L	Wood	\$92.00
 BYF4003F	Austell	3 1/4" H x 3 5/8" L 83mm H x 91mm L	Wood	\$92.00
 BYF4004F	Ives	3 1/8" H x 3 7/8" L 79mm H x 98mm L	Wood	\$92.00
 BYF4005F	Saltash	3 1/3" H x 4 3/4" L 84mm H x 121mm L	Wood	\$92.00

## 1 3/4" - 45mm POLES & RINGS

Item Number	Item Name	Dimensions Inches / Metric	Top of Pole to Eyelet	Material	Retail Price Each
 BYSP404F	4' Pole*	47 1/4" L 120cm L		Wood	\$202.00
 BYSP405F	5' Pole*	59" L 150cm L		Wood	\$250.00
 BYSP406F	6' Pole*	70 7/8" L 180cm L		Wood	\$276.00
 BYSP407F	7' Pole*	82 5/8" L 210cm L		Wood	\$340.00
 BYSP408F	8' Pole*	94 1/2" L 240cm L		Wood	\$366.00
 BYR4600F	Ring	3" OD - 2 1/4" ID 77mm OD - 57mm ID	3" 75mm	Wood	\$14.00

\* Advise when splicing poles for longer lengths. Center support brackets required.

Review ACTUAL pole lengths in inches listed above before ordering.













### BARNWOOD FINISHES

Calico 906	Natural Stone 914	Barnwood Cream 915	Barnwood White 916
Dove Grey 940	Barnwood Grey 943	Moss Green 981	Barnwood Green 916

\*\* METAL FINISHES: Brass 820    Antique Brass 830    Chrome 840

# BARNWOOD COLLECTION

1 3/4" - 45 mm

1 3/4" - 45mm BRACKETS						
Item Number	Item Name	Dimensions Inches / Metric	Projection	Material	Retail Price Each	
 BYB4500F	Cup Bracket	2 7/8" Base x 6 1/8" L 72mm Base x 156mm L	4 3/8" 110mm	Wood	\$50.00	
 BYB4501F	Extended Cup Bracket	2 7/8" Base x 8 3/4" L 73mm Base x 221mm L	7 1/8" 180mm	Wood	\$74.00	
 BYB4502F	Double Cup Bracket (35mm/45mm)	3 1/4" Base x 9 1/2" L 82mm Base x 242mm L	3 1/4" - 82mm (BP) 7 1/2" - 190mm (FP)	Wood	\$92.00	
 BYB4503F	Inside Mount Bracket	3 1/2" Base x 1 3/4" L 90mm Base x 44mm L	1/4" 6mm	Wood	\$44.00	
 BYB4504F	Double Architrave Bracket (35mm/45mm)	5 7/8" H x 1" Base x 8 7/8" L 150mm H x 26mm Base x 224mm L	3 3/4" - 95mm (BP) 7 3/8" - 187mm (FP)	Wood	\$114.00	
 BYB4505F	Closed/Ceiling Bracket	2 7/8" Base x 6 1/8" L 72mm Base x 156mm L	4 3/8" 110mm	Wood	\$50.00	
 BYB4507F	Decorative Architrave Bracket	5 3/4" H x 1" Base x 6" L 146mm H x 26mm Base x 152mm L	3 1/4" 81mm	Wood	\$88.00	
 BYB4508F	Architrave Bracket	6 3/4" H x 1" Base x 5 1/2" L 170mm H x 26mm Base x 139mm L	3 7/8" 99mm	Wood	\$78.00	
 BYB4509F	Ext. Architrave Bracket	5 7/8" H x 1" Base x 8 3/4" L 150mm H x 26mm Base x 222mm L	7 3/8" 187mm	Wood	\$114.00	
 BYB4550F	Invisible Bracket*	3 1/4" H x 1 5/8" Base x 6" L 82mm H x 40mm Base x 152mm L	5 1/2" 140mm	Metal	\$106.00	
 BYB4551F	Metal Center Bracket	1 3/8" H x 2 3/8" Base x 4" L 35mm H x 60mm Base x 100mm L	2 3/8" 60mm	Metal **	\$132.00	
 BYB4552F	Metal End Bracket	5 1/2" H x 1/2" Base x 4" L 136mm H x 14mm Base x 100mm L	2 3/8" 60mm	Metal **	\$132.00	
 BYB4560F	Elbow Bracket	2 1/8" Base x 3 3/4" L 54mm Base x 95mm L		Wood	\$106.00	

Review ACTUAL pole lengths in inches listed above before ordering.

\*Invisible bracket ONLY available in finish 830 Antique Brass.

Note: Advise when splicing poles for longer lengths. Center support brackets required

## BARNWOOD FINISHES

Calico 906

Natural Stone 914

Barnwood Cream 915

Barnwood White 916

Dove Grey 940

Barnwood Grey 943

Moss Green 981







Barnwood Green 916

\*\* METAL FINISHES: Brass 820 Antique Brass 830 Chrome 840







# BARNWOOD COLLECTION

2 1/8" - 55 mm



## 2 1/8" - 55mm FINIALS & END CAPS

Item Number	Item Name	Dimensions Inches / Metric	Material	Retail Price Each
 BYF5000F	End Cap	2 3/4" H x 1 1/8" L 70mm H x 28mm L	Wood	\$82.00
 BYF5001F	Carbis	3 7/8" H x 5 3/8" L 98mm H x 136mm L	Wood	\$174.00
 BYF5002F	Lamorna	3 5/8" H x 4 1/8" L 91mm H x 104mm L	Wood	\$174.00
 BYF5003F	Austell	3 5/8" H x 4 1/2" L 92mm H x 115mm L	Wood	\$174.00
 BYF5004F	Ives	3 1/2" H x 4 1/2" L 90mm H x 115mm L	Wood	\$174.00
 BYF5005F	Saltash	3 3/4" H x 5 1/4" L 96mm H x 133mm L	Wood	\$174.00

## 2 1/8" - 55mm POLES & RINGS

Item Number	Item Name	Dimensions Inches / Metric	Top of Pole to Eyelet	Material	Retail Price Each
 BYSP504F	4' Pole*	47 1/4" L 120cm L		Wood	\$300.00
 BYSP505F	5' Pole*	59" L 150cm L		Wood	\$400.00
 BYSP506F	6' Pole*	70 7/8" L 180cm L		Wood	\$428.00
 BYSP507F	7' Pole*	82 5/8" L 210cm L		Wood	\$518.00
 BYSP508F	8' Pole*	94 1/2" L 240cm L		Wood	\$532.00
 BYR5600F	Ring	3 5/8" OD - 2 5/8" ID 92mm OD - 66mm ID	3 5/8" L 92mm L	Wood	\$16.00

## WANDS

Item Number	Item Name	Dimensions Inches / Metric	Material	Retail Price Each
 BYU9500F	Wand	39 3/5" L 1m L	Wood	\$96.00
 BYU6036F	Wand	36" L 92cm L	Acrylic	\$48.00
 BYU6048F	Wand	48" L 122cm L	Acrylic	\$54.00

\* Advise when splicing poles for longer lengths. Center support brackets required.

Review ACTUAL pole lengths in inches listed above before ordering.













## BARNWOOD FINISHES

Calico 906	Natural Stone 914	Barnwood Cream 915	Barnwood White 916
Dove Grey 940	Barnwood Grey 943	Moss Green 981	Barnwood Green 916





# BARNWOOD COLLECTION

2 1/8" - 55 mm

## 2 1/8" - 55mm BRACKETS

Item Number	Item Name	Dimensions Inches / Metric	Projection	Material	Retail Price Each	
					Finish A	Finish B
 BYB5500F	Cup Bracket	3" Base x 6 1/8" L 76mm Base x 155mm L	4 1/4" 110mm	Wood	\$116.00	
 BYB5501F	Extended Cup Bracket	3 1/4" Base x 8 1/2" L 82mm Base x 217mm L	6 1/2" 164mm	Wood	\$130.00	
 BYB5502F	Double Cup Bracket (35mm/55mm)	3 1/4" Base x 9 1/2" L 82mm Base x 242mm L	3 1/3" - 85mm (BP) 7 1/2" - 190mm (FP)	Wood	\$166.00	
 BYB5503F	Inside Mount Bracket	3 7/8" Base x 1 3/4" L 97mm Base x 44mm L	1/4" 6mm	Wood	\$110.00	
 BYB5504F	Double Architrave Bracket (35mm/55mm)	5 7/8" H x 1" Base x 9 1/4" L 150mm H x 26mm Base x 235mm L	3 7/8" - 99mm (BP) 7 1/2" - 191mm (FP)	Wood	\$166.00	
 BYB5505F	Closed/Ceiling Bracket	3 1/4" Base x 6 1/4" L 81mm Base x 158mm L	4 3/8" 111mm	Wood	\$116.00	
 BYB5507F	Decorative Architrave Bracket	6" H x 1" Base x 6 1/8" L 152mm H x 26mm Base x 156mm L	3 3/8" 86mm	Wood	\$140.00	
 BYB5508F	Architrave Bracket	6 3/4" H x 1" Base x 5 1/2" L 170mm H x 26mm Base x 139mm L	3 7/8" 97mm	Wood	\$126.00	
 BYB5509F	Ext. Architrave Bracket	5 7/8" H x 1" Base x 8 3/4" L 150mm H x 26mm Base x 222mm L	7 3/8" 187mm	Wood	\$166.00	
 BYB5550F	Invisible Bracket*	3 1/4" H x 1 5/8" Base x 6" L 82mm H x 40mm Base x 152mm L	5 1/2" 140mm	Metal	\$106.00	
 BYB5551F	Metal Center Bracket	1 5/8" H x 2 5/8" Base x 4 1/4" L 40mm H x 68mm Base x 107mm L	2 1/2" 64mm	Metal **	\$148.00	
 BYB5552F	Metal End Bracket	5 1/2" H x 5/8" Base x 4 1/4" L 140mm H x 16mm Base x 107mm L	2 1/2" 64mm	Metal **	\$148.00	
 BYB5560F	Elbow Bracket	2 1/2" Base x 4 1/2" L 65mm Base x 113mm L		Wood	\$126.00	

## HOLDBACKS

Item Number	Item Name	Dimensions Inches / Metric	Stem Length	Material	Retail Price Each	
					Finish A	Finish B
 BYH9001F	Classic Holdback	4 3/4" H x 6 1/4" L 120mm H x 159mm L	5 1/2" 140mm	Wood	\$92.00	
 BYH9002F	Decorative Holdback	5 1/2" H x 6 7/8" L 140mm H x 175mm L	5 1/2" 140mm	Resin	\$162.00	
 BYH9003F	Stepped Holdback	3 3/4" H x 5 1/8" L 95mm H x 130mm L	4" 100mm	Wood	\$92.00	
 BYH9004F	French Holdback	3 1/2" H x 7 1/2" L 90mm H x 190mm L	4 3/4" 120mm	Wood	\$140.00	

Review ACTUAL pole lengths in inches listed above before ordering.

\*Invisible bracket ONLY available in finish 830 Antique Brass.

Note: Advise when splicing poles for longer lengths. Center support brackets required

## BARNWOOD FINISHES





Calico 906	Natural Stone 914	Barnwood Cream 915	Barnwood White 916
Dove Grey 940	Barnwood Grey 943	Moss Green 981	Barnwood Green 916

\*\* METAL FINISHES: Brass 820 Antique Brass 830 Chrome 840







# RUSTICA COLLECTION

1 3/8" - 35 mm

## 1 3/8" - 35mm FINIALS & END CAPS

Item Number	Item Name	Dimensions Inches/Metric	Material	Retail Price Each	
				Finish A	Finish B
 BYF3040F	End Cap	1 3/4" H x 1 1/8" L 46mm H x 28mm L	Wood	\$64.00	\$44.00
 BYF3041F	Raphael	2 3/4" H x 3 7/8" L 71mm H x 98mm L	Wood	\$140.00	\$110.00
 BYF3042F	Toulon	2" H x 2 1/4" L 50mm H x 58mm L	Wood	\$92.00	\$72.00
 BYF3043F	Remy	2 7/8" H x 3 1/2" L 73mm H x 89mm L	Wood	\$140.00	\$110.00
 BYF3044F	Lyon	2 7/8" H x 3 7/8" L 72mm H x 99mm L	Wood	\$140.00	\$110.00

## 1 3/8" - 35mm POLES & RINGS

Item Number	Item Name	Dimensions Inches/Metric	Top of Pole to Eyelet	Material	Retail Price Each	
					Finish A	Finish B
 BYSP344F	4' Pole*	47 1/4" 120cm L		Wood	\$194.00	\$166.00
 BYSP345F	5' Pole*	59" L 150cm L		Wood	\$220.00	\$194.00
 BYSP346F	6' Pole*	70 7/8" L 180cm L		Wood	\$250.00	\$214.00
 BYSP347F	7' Pole*	82 5/8" L 210cm L		Wood	\$340.00	\$276.00
 BYSP348F	8' Pole*	94 1/2" L 240cm L		Wood	\$366.00	\$312.00
 BYR3640F	Ring	2 1/2" OD - 1 3/4" ID 65mm OD - 45mm ID	2 3/4" 70mm	Wood	\$14.00	\$12.00

\* Advise when splicing poles for longer lengths. Center support brackets required.

Review ACTUAL pole lengths in inches listed above before ordering.

### RUSTICA FINISHES

Finish A: English Oak 913













Finish B: Limed Oak 912 Smoked Oak 933 Toasted Oak 934 Burnt Oak 935

\*\*METAL FINISHES: Brass 820 Chrome 840 Antique Brass 830



# RUSTICA COLLECTION

1 3/8" - 35 mm

1 3/8" - 35mm BRACKETS							
Item Number	Item Name	Dimensions Inches/Metric	Projection	Material	Retail Price Each		
					Finish A	Finish B	
 BYB3540F	Cup Bracket	2 3/8" Base x 5 3/8" L 61mm Base x 138mm L	4 1/8" 104mm	Wood	\$64.00	\$50.00	
 BYB3541F	Extended Cup Bracket	2 1/2" Base x 8 5/8" L 63mm Base x 219mm L	7 1/8" 182mm	Wood	\$94.00	\$76.00	
 BYB3542F	Double Cup Bracket (35mm/35mm)	2 3/8" Base x 9 5/8" L 60mm H x 244mm L	4 3/4" - 122mm (BP) 8 1/4" - 209mm (FP)	Wood	\$126.00	\$102.00	
 BYB3543F	Inside Mount Bracket	2 1/2" Base x 1 5/8" L 63mm Base x 42mm L	1/4" 6mm	Wood	\$62.00	\$44.00	
 BYB3544F	Double Architrave Bracket (35mm/35mm)	5 7/8" H x 1" Base x 8 7/8" L 150mm H x 26mm Base x 224mm L	3 5/8" - 91mm (BP) 7 1/2" - 191mm (FP)	Wood	\$168.00	\$132.00	
 BYB3545F	Closed/Ceiling Bracket	2 1/8" Base x 5 1/2" L 54mm Base x 140mm L	4 1/8" 106mm	Wood	\$70.00	\$54.00	
 BYB3547F	Decorative Architrave Bracket	5 3/4" H x 1" Base x 6" L 146mm H x 26mm Base x 152mm L	3 3/8" 85mm	Wood	\$126.00	\$100.00	
 BYB3548F	Architrave Bracket	6 3/4" H x 1" Base x 5 1/2" L 170mm H x 26mm Base x 139mm L	4 1/8" 105mm	Wood	\$114.00	\$92.00	
 BYB3549F	Ext. Architrave Bracket	5 7/8" H x 1" Base x 8 3/4" L 150mm H x 26mm Base x 224mm L	7 3/8" 187mm	Wood	\$168.00	\$132.00	
 BYB3550F	Invisible Bracket*	3 1/4" H x 1 5/8" Base x 6" L 82mm H x 40mm Base x 152mm L	5 1/2" 140mm	Metal	\$106.00		
 BYB3551F	Metal Center Bracket	1 3/8" H x 2 3/8" Base x 3 5/8" L 35mm H x 60mm Base x 91mm L	2 1/4" 56mm	Metal **	\$126.00		
 BYB3552F	Metal End Bracket	5 3/8" H x 1/2" Base x 3 3/8" L 136mm H x 14mm Base x 91mm L	2 1/4" 56mm	Metal **	\$126.00		
 BYB3564F	Elbow Bracket	1 3/4" Base x 3 3/8" L 45mm Base x 85mm L		Wood	\$174.00	\$142.00	

Review ACTUAL pole lengths in inches listed above before ordering.

\*Invisible bracket ONLY available in finish 830 Antique Brass.

Note: Advise when splicing poles for longer lengths. Center support brackets required

## RUSTICA FINISHES

Finish A: English Oak 913







Finish B: Limed Oak 912 Smoked Oak 933 Toasted Oak 934 Burnt Oak 935

\*\*METAL FINISHES: Brass 820 Chrome 840 Antique Brass 830







# RUSTICA COLLECTION

1 3/4" - 45 mm

## 1 3/4" - 45mm FINIALS & END CAPS

Item Number	Item Name	Dimensions Inches / Metric	Material	Retail Price Each	
				Finish A	Finish B
 BYF4040F	End Cap	2 3/8" H x 1 1/8" L 59mm H x 29mm L	Wood	\$84.00	\$64.00
 BYF4041F	Raphael	3 1/8" H x 4 3/8" L 79mm H x 110mm L	Wood	\$160.00	\$132.00
 BYF4042F	Toulon	2 1/2" H x 2 3/8" L 62mm H x 59mm L	Wood	\$110.00	\$84.00
 BYF4043F	Remy	3 1/4" H x 3 7/8" L 82mm H x 98mm L	Wood	\$160.00	\$132.00
 BYF4044F	Lyon	3 1/8" H x 4 1/8" L 79mm H x 105mm L	Wood	\$160.00	\$132.00
 BYF4045F	Chantilly	3 5/8" H x 6 1/8" L 92mm H x 154mm L	Wood	\$194.00	\$160.00

## 1 3/4" - 45mm POLES & RINGS

Item Number	Item Name	Dimensions Inches / Metric	Top of Pole to Eyelet	Material	Retail Price Each	
					Finish A	Finish B
 BYSP444F	4' Pole*	47 1/4" L 120cm L		Wood	\$250.00	\$230.00
 BYSP445F	5' Pole*	59" L 150cm L		Wood	\$304.00	\$250.00
 BYSP446F	6' Pole*	70 7/8" L 180cm L		Wood	\$336.00	\$276.00
 BYSP447F	7' Pole*	82 5/8" L 210cm L		Wood	\$402.00	\$352.00
 BYSP448F	8' Pole*	94 1/2" L 240cm L		Wood	\$474.00	\$380.00
 BYR4640F	Ring	3" OD - 2 1/4" ID 77mm OD - 57mm ID	3" 75mm	Wood	\$16.00	\$14.00

\* Advise when splicing poles for longer lengths. Center support brackets required.  
Review ACTUAL pole lengths in inches listed above before ordering.

### RUSTICA FINISHES











Finish A: English Oak 913

Finish B: Limed Oak 912 Smoked Oak 933 Toasted Oak 934 Burnt Oak 935

\*\*METAL FINISHES: Brass 820 Chrome 840 Antique Brass 830

# RUSTICA COLLECTION

1 3/4" - 45 mm

1 3/4" - 45mm BRACKETS							
Item Number	Item Name	Dimensions Inches/Metric	Projection	Material	Retail Price Each		
					Finish A	Finish B	
	BYB4540F	Cup Bracket	2 7/8" Base x 6 1/8" L 72mm Base x 156mm L	4 3/8" 110mm	Wood	\$84.00	\$60.00
	BYB4541F	Extended Cup Bracket	2 7/8" Base x 8 3/4" L 73mm Base x 221mm L	7 1/8" 180mm	Wood	\$106.00	\$82.00
	BYB4542F	Double Cup Bracket (35mm/45mm)	3 1/4" Base x 9 1/2" L 82mm Base x 242mm L	3 1/4" - 82mm (BP) 7 1/2" - 190mm (FP)	Wood	\$126.00	\$114.00
	BYB4543F	Inside Mount Bracket	3 1/2" Base x 1 3/4" L 90mm Base x 44mm L	1/4" 6mm	Wood	\$76.00	\$62.00
	BYB4544F	Double Architrave Bracket (35mm/45mm)	5 7/8" H x 1" Base x 8 7/8" L 150mm H x 26mm Base x 224mm L	3 3/4" - 95mm (BP) 7 3/8" - 187mm (FP)	Wood	\$168.00	\$132.00
	BYB4545F	Closed/Ceiling Bracket	2 7/8" Base x 6 1/8" L 72mm Base x 156mm L	4 3/4" 110mm	Wood	\$88.00	\$62.00
	BYB4547F	Decorative Architrave Bracket	5 3/4" H x 1" Base x 6" L 146mm H x 26mm Base x 152mm L	3 1/4" 81mm	Wood	\$126.00	\$100.00
	BYB4548F	Architrave Bracket	6 3/4" H x 1" Base x 5 1/2" L 170mm H x 26mm Base x 139mm L	3 7/8" 97mm	Wood	\$114.00	\$92.00
	BYB4549F	Ext. Architrave Bracket	5 7/8" H x 1" Base x 8 3/4" L 150mm H x 26mm Base x 224mm L	7 3/8" 187mm	Wood	\$168.00	\$132.00
	BYB4550F	Invisible Bracket*	3 1/4" H x 1 5/8" Base x 6" L 82mm H x 40mm Base x 152mm L	5 1/2" 140mm	Metal	\$106.00	
	BYB4551F	Metal Center Bracket	1 3/8" H x 2 3/8" Base x 4" L 35mm H x 60mm Base x 100mm L	2 3/8" 60mm	Metal **	\$132.00	
	BYB4552F	Metal End Bracket	5 1/2" H x 1/2" Base x 4" L 136mm H x 14mm Base x 100mm L	2 3/8" 60mm	Metal **	\$132.00	
	BYB4564F	Elbow Bracket	2 1/8" Base x 3 3/4" L 54mm Base x 95mm L		Wood	\$194.00	\$162.00

Review ACTUAL pole lengths in inches listed above before ordering.

\*Invisible bracket ONLY available in finish 830 Antique Brass.

Note: Advise when splicing poles for longer lengths. Center support brackets required

## RUSTICA FINISHES

Finish A: English Oak 913





Finish B: Limed Oak 912 Smoked Oak 933 Toasted Oak 934 Burnt Oak 935

\*\*METAL FINISHES: Brass 820 Chrome 840 Antique Brass 830







# RUSTICA COLLECTION

2 1/8" - 55 mm



## 2 1/8" - 55mm FINIALS & END CAPS

Item Number	Item Name	Dimensions Inches/Metric	Content	Retail Price Each	
				Finish A	Finish B
 BYF5040F	End Cap	3" H x 1 1/8" L 76mm Base x 28mm L	Wood	\$100.00	\$80.00
 BYF5042F	Toulon	2 3/4" H x 2 7/8" L 71mm H x 73mm L	Wood	\$140.00	\$110.00
 BYF5044F	Lyon	3 1/4" H x 4 3/8" L 83mm H x 110mm L	Wood	\$194.00	\$146.00
 BYF5045F	Chantilly	3 2/5" H x 6 1/8" L 93mm H x 156mm L	Wood	\$236.00	\$194.00

## 2 1/8" - 55mm POLES & RINGS

Item Number	Item Name	Dimensions Inches / Metric	Top of Pole to Eyelet	Material	Retail Price Each	
					Finish A	Finish B
 BYSP544F	4' Pole*	47 1/4" L 120cm L		Wood	\$350.00	\$292.00
 BYSP545F	5' Pole*	59" L 150cm L		Wood	\$400.00	\$312.00
 BYSP546F	6' Pole*	70 7/8" L 180cm L		Wood	\$474.00	\$362.00
 BYSP547F	7' Pole*	82 5/8" L 210cm L		Wood	\$550.00	\$416.00
 BYSP548F	8' Pole*	94 1/2" L 240cm L		Wood	\$602.00	\$472.00
 BYR5640F	Ring	3 5/8" OD - 2 5/8" ID 92mm OD - 66mm ID	3 5/8" 92mm	Wood	\$20.00	\$16.00

## WAND

Item Number	Item Name	Dimensions Inches / Metric	Material	Retail Price Each
 BYU9504F	Wand	39 3/5" L 1m L	Wood	\$122.00
 BYU6036F	Wand	36" L 92cm L	Acrylic	\$48.00
 BYU6048F	Wand	48" L 122cm L	Acrylic	\$54.00

\* Advise when splicing poles for longer lengths. Center support brackets required.  
Review ACTUAL pole lengths in inches listed above before ordering.

## RUSTICA FINISHES







Finish A: English Oak 913



Finish B: Limed Oak 912 Smoked Oak 933 Toasted Oak 934 Burnt Oak 935

\*\*METAL FINISHES: Brass 820 Chrome 840 Antique Brass 830

# RUSTICA COLLECTION

2 1/8" - 55 mm

2 1/8" - 55mm BRACKETS							
Item Number	Item Name	Dimensions Inches / Metric	Projection	Material	Retail Price Each		
					Finish A	Finish B	
 BYB5540F	Cup Bracket	3 1/4" Base x 6 1/8" L 83mm Base x 156mm L	4 1/4" 108mm	Wood	\$114.00	\$90.00	
 BYB5541F	Extended Cup Bracket	3 1/8" Base x 8 3/8" L 80mm Base x 213mm L	6 1/2" 166mm	Wood	\$190.00	\$150.00	
 BYB5542F	Double Cup Bracket (35mm/55mm)	3 1/4" Base x 9 1/2" L 82mm Base x 242mm L	3 3/8" - 85mm (BP) 7 1/2" - 190mm (FP)	Wood	\$190.00	\$150.00	
 BYB5543F	Inside Mount Bracket	3 7/8" Base x 1 3/4" L 98mm Base x 43mm L	1/4" 6mm	Wood	\$110.00	\$86.00	
 BYB5544F	Double Architrave Bracket (35mm/55mm)	5 7/8" H x 1" Base x 9 1/4" L 150mm H x 26mm Base x 235mm L	3 7/8" - 99mm (BP) 7 1/2" - 191mm (FP)	Wood	\$190.00	\$150.00	
 BYB5545F	Closed/Ceiling Bracket	3 1/4" Base x 6 1/4" L 81mm Base x 158mm L	4 3/8" 111mm	Wood	\$120.00	\$94.00	
 BYB5547F	Decorative Architrave Bracket	6" H x 1" Base x 6 1/8" L 152mm H x 26mm Base x 156mm L	3 3/8" 86mm	Wood	\$162.00	\$126.00	
 BYB5548F	Architrave Bracket	6 3/4" H x 1" Base x 5 1/2" L 170mm H x 26mm Base x 139mm L	3 7/8" 97mm	Wood	\$148.00	\$114.00	
 BYB5549F	Ext. Architrave Bracket	5 7/8" H x 1" Base x 8 3/4" L 150mm H x 26mm Base x 222mm L	7 3/8" 187mm	Wood	\$190.00	\$150.00	
 BYB5550F	Invisible Bracket*	3 1/4" H x 1 5/8" Base x 6" L 82mm H x 40mm Base x 177mm L	5 1/2" 140mm	Metal	\$106.00		
 BYB5551F	Metal Center Bracket	1 5/8" H x 2 5/8" Base x 4 1/4" L 40mm H x 68mm Base x 107mm L	2 1/2" 64mm	Metal **	\$148.00		
 BYB5552F	Metal End Bracket	5 1/2" H x 5/8" Base x 4 1/4" L 140mm H x 16mm Base x 107mm L	2 1/2" 64mm	Metal **	\$148.00		
 BYB5564F	Elbow Bracket	2 1/2" Base x 4 1/2" L 65mm Base x 113mm L		Wood	\$222.00	\$176.00	

HOLDBACKS							
Item Number	Item Name	Dimensions Inches / Metric	Stem Length	Material	Retail Price Each		
					Finish A	Finish B	
 BYH9041F	Classic Holdback	4 3/4" H x 6 1/4" L 120mm H x 159mm L	5 1/2" 140mm	Wood	\$152.00	\$98.00	
 BYH9044F	French Holdback	3 1/2" H x 7 1/2" L 90mm H x 190mm L	4 3/4" 120mm	Wood	\$194.00	\$132.00	

Review ACTUAL pole lengths in inches listed above before ordering.

\*Invisible bracket ONLY available in finish 830 Antique Brass.

Note: Advise when splicing poles for longer lengths. Center support brackets required

## RUSTICA FINISHES

Finish A: English Oak 913







Finish B: Limed Oak 912 Smoked Oak 933 Toasted Oak 934 Burnt Oak 935

\*\*METAL FINISHES: Brass 820 Chrome 840 Antique Brass 830

# NEON FLORAL COLLECTION

1 3/8" - 35 mm

1 3/8" - 35mm FINIALS & END CAPS					
Item Number	Item Name	Dimensions Inches / Metric	Material	Retail Price Each	
 BYF3020F	End Cap	1 3/4" H x 1 1/8" L 46mm H x 28mm L	Wood	\$42.00	
 BYF3021F	Daisy	2 1/2" H x 5 1/8" L 62mm H x 130mm L	Resin	\$98.00	
 BYF3022F	Posy	3 3/4" H x 4 1/8" L 96mm H x 105mm L	Resin	\$120.00	
 BYF3023F	Peony	3 1/4" H x 3 3/8" L 81mm H x 85mm L	Resin	\$98.00	
 BYF3024F	Modern Ball	2 7/8" H x 3 7/8" L 72mm H x 100mm L	Wood	\$82.00	

1 3/8" - 35mm POLES & RINGS						
Item Number	Item Name	Dimensions Inches / Metric	Top of Pole to Eyelet	Material	Retail Price Each	
 BYSP324F	4' Pole*	47 1/4" L 120cm L		Wood	\$152.00	
 BYSP325F	5' Pole*	59" L 150cm L		Wood	\$182.00	
 BYSP326F	6' Pole*	70 7/8" L 180cm L		Wood	\$208.00	
 BYSP327F	7' Pole*	82 5/8" L 210cm L		Wood	\$276.00	
 BYSP328F	8' Pole*	94 1/2" L 240cm L		Wood	\$330.00	
 BYR3620F	Ring	2 1/2" OD - 1 3/4" ID 65mm OD - 45mm ID	2 3/4" 70mm	Wood	\$10.00	

\* Advise when splicing poles for longer lengths. Center support brackets required.  
Review ACTUAL pole lengths in inches listed above before ordering.













## NEON FINISHES

Matte White 900 Yellow 920 Orange 960 Baby Pink 961 Fuchsia 962  
Raspberry 963 Red 964 Aubergine 970 Navy 971 Turquoise 972 Lime Green 980

\*\*METAL FINISHES: Brass 820 Chrome 840 Antique Brass 830

# NEON FLORAL COLLECTION

1 3/8" - 35 mm

1 3/8" - 35mm BRACKETS						
Item Number	Item Name	Dimensions Inches / Metric	Projection	Material	Retail Price Each	
 BYB3521F	Extended Floral Cup Bracket	2 1/2" Base x 8 1/8" L 64mm Base x 206mm L	6 3/4" 172mm	Wood	\$80.00	
 BYB3522F	Double Floral Cup Bracket (35mm/35mm)	2 3/8" Base x 9 5/8" L 60mm Base x 244mm L	4 3/4" - 122mm (BP) 8 1/4" - 209mm (FP)	Wood	\$106.00	
 BYB3523F	Inside Mount Bracket	2 1/2" Base x 1 5/8" L 63mm Base x 42mm L	1/4" 6mm	Wood	\$42.00	
 BYB3524F	Double Architrave Bracket (35mm/35mm)	5 7/8" H x 1" Base x 8 7/8" L 150mm H x 26mm Base x 224mm L	3 3/8" - 91mm (BP) 7 1/2" - 191mm (FP)	Wood	\$126.00	
 BYB3525F	Closed/Ceiling Bracket	2 1/4" Base x 5 3/8" L 58mm Base x 136mm L	4 1/8" 105mm	Wood	\$50.00	
 BYB3526F	Floral Cup Bracket	2 1/4" Base x 5 3/8" L 58mm Base x 136mm L	4 1/8" 104mm	Wood	\$48.00	
 BYB3527F	Decorative Architrave Bracket	5 3/4" H x 1" Base x 6" L 146mm H x 26mm Base x 152mm L	3 3/8" 85mm	Wood	\$94.00	
 BYB3528F	Architrave Bracket	6 3/4" H x 1" Base x 5 1/2" L 170mm H x 26mm Base x 139mm L	4 1/8" 105mm	Wood	\$80.00	
 BYB3529F	Ext. Architrave Bracket	5 7/8" H x 1" Base x 8 3/4" L 150mm H x 26mm Base x 222mm L	7 3/8" 187mm	Wood	\$114.00	
 BYB3550F	Invisible Bracket*	3 1/4" H x 1 5/8" Base x 6" L 82mm H x 40mm Base x 152mm L	5 1/2" 140mm	Metal	\$106.00	
 BYB3551F	Metal Center Bracket	1 3/8" H x 2 3/8" Base x 3 5/8" L 35mm H x 60mm Base x 91mm L	2 1/4" 56mm	Metal **	\$126.00	
 BYB3552F	Metal End Bracket	5 3/8" H x 1/2" Base x 3 5/8" L 136mm H x 14mm Base x 91mm L	2 1/4" 56mm	Metal **	\$126.00	
 BYB3562F	Elbow Bracket	1 3/4" Base x 3 3/8" L 45mm Base x 85mm L		Wood	\$100.00	

Review ACTUAL pole lengths in inches listed above before ordering.

\*Invisible bracket ONLY available in finish 830 Antique Brass.

Note: Advise when splicing poles for longer lengths. Center support brackets required

## NEON FINISHES

Matte White 900 Yellow 920 Orange 960 Baby Pink 961 Fuchsia 962







Raspberry 963 Red 964 Aubergine 970 Navy 971 Turquoise 972 Lime Green 980

\*\*METAL FINISHES: Brass 820 Chrome 840 Antique Brass 830

# NEON FLORAL COLLECTION

1 3/4" - 45 mm

1 3/4" - 45mm FINIALS & END CAPS					
Item Number	Item Name	Dimensions Inches / Metric	Material	Retail Price Each	
 BYF4020F	End Cap	2 3/8" H x 1 1/8" L 59mm H x 29mm L	Wood	\$42.00	
 BYF4021F	Daisy	2 3/4" H x 5 3/5" L 70mm H x 142mm L	Resin	\$110.00	
 BYF4022F	Posy	3 3/4" H x 4 1/4" L 96mm H x 108mm L	Resin	\$142.00	
 BYF4023F	Peony	3 3/8" H x 3 3/4" L 86mm H x 95mm L	Resin	\$110.00	
 BYF4024F	Modern Ball	3 3/8" H x 4 7/8" L 85mm H x 125mm L	Wood	\$94.00	
 BYF4025F	Rose	4 3/4" H x 4 3/4" L 122mm H x 122mm L	Resin	\$142.00	

1 3/4" - 45mm POLES & RINGS					
Item Number	Item Name	Dimensions Inches / Metric	Top of Pole to Eyelet	Material	Retail Price Each
 BYSP424F	4' Pole*	47 1/4" L 120cm L		Wood	\$194.00
 BYSP425F	5' Pole*	59" L 150cm L		Wood	\$230.00
 BYSP426F	6' Pole*	70 7/8" L 180cm L		Wood	\$276.00
 BYSP427F	7' Pole*	82 5/8" L 210cm L		Wood	\$340.00
 BYSP428F	8' Pole*	94 1/2" L 240cm L		Wood	\$380.00
 BYR4620F	Ring	3" OD - 2 1/4" ID 77mm OD - 57mm ID	3" 75mm	Wood	\$16.00

\* Advise when splicing poles for longer lengths. Center support brackets required.  
Review ACTUAL pole lengths in inches listed above before ordering.













## NEON FINISHES

Matte White 900 Yellow 920 Orange 960 Baby Pink 961 Fuchsia 962  
Raspberry 963 Red 964 Aubergine 970 Navy 971 Turquoise 972 Lime Green 980  
\*\*METAL FINISHES: Brass 820 Chrome 840 Antique Brass 830



# NEON FLORAL COLLECTION

1 3/4" - 45 mm

1 3/4" - 45mm BRACKETS						
Item Number	Item Name	Dimensions Inches / Metric	Projection	Material	Retail Price Each	
 BYB4521F	Extended Floral Cup Bracket	2 7/8" Base x 8 3/4" L 73mm Base x 221mm L	7 1/8" 180mm	Wood	\$80.00	
 BYB4522F	Double Floral Cup Bracket (35mm/45mm)	3 1/4" Base x 9 1/2" L 82mm Base x 242mm L	3 1/4" - 82mm (BP) 7 1/2" - 190mm (FP)	Wood	\$84.00	
 BYB4523F	Inside Mount Bracket	3 1/2" Base x 1 3/4" L 90mm Base x 44mm L	1/4" 6mm	Wood	\$50.00	
 BYB4524F	Double Architrave Bracket (35mm/45mm)	5 7/8" H x 1" Base x 8 7/8" L 150mm H x 25mm Base x 224mm L	3 3/4" - 95mm (BP) 7 3/8" - 187mm (FP)	Wood	\$132.00	
 BYB4525F	Closed/Ceiling Bracket	2 3/4" Base x 6 1/4" L 70mm Base x 160mm L	4 7/8" 123mm	Wood	\$56.00	
 BYB4526F	Floral Cup Bracket	2 5/8" Base x 6 1/8" L 68mm Base x 154mm L	4 7/8" 123mm	Wood	\$54.00	
 BYB4527F	Decorative Architrave Bracket	5 3/4" H x 1" Base x 6" L 146mm H x 26mm Base x 152mm L	3 1/4" 81mm	Wood	\$94.00	
 BYB4528F	Architrave Bracket	6 3/4" H x 1" Base x 5 1/2" L 170mm H x 26mm Base x 139mm L	3 7/8" 97mm	Wood	\$88.00	
 BYB4529F	Ext. Architrave Bracket	5 7/8" H x 1" Base x 8 3/4" L 150mm H x 26mm Base x 222mm L	7 3/8" 187mm	Wood	\$114.00	
 BYB4550F	Invisible Bracket*	3 1/4" H x 1 5/8" Base x 6" L 82mm H x 40mm Base x 152mm L	5 1/2" 140mm	Metal	\$106.00	
 BYB4551F	Metal Center Bracket	1 3/8" H x 2 3/8" Base x 4" L 35mm H x 60mm Base x 100mm L	2 3/8" 60mm	Metal **	\$132.00	
 BYB4552F	Metal End Bracket	5 1/2" H x 1/2" Base x 4" L 136mm H x 14mm Base x 100mm L	2 3/8" 60mm	Metal **	\$132.00	
 BYB4562F	Elbow Bracket	2 1/8" Base x 3 3/4" L 54mm Base x 95mm L		Wood	\$112.00	

Review ACTUAL pole lengths in inches listed above before ordering.

\*Invisible bracket ONLY available in finish 830 Antique Brass.

Note: Advise when splicing poles for longer lengths. Center support brackets required

## NEON FINISHES





Matte White 900 Yellow 920 Orange 960 Baby Pink 961 Fuchsia 962  
Raspberry 963 Red 964 Aubergine 970 Navy 971 Turquoise 972 Lime Green 980

\*\*METAL FINISHES: Brass 820 Chrome 840 Antique Brass 830







# NEON FLORAL COLLECTION

2 1/8" - 55 mm



## 2 1/8" - 55mm FINIALS & END CAPS

Item Number	Item Name	Dimensions Inches / Metric	Material	Retail Price Each
 BYF5020F	End cap	3" H x 1 1/8" L 76mm H x 28mm L	Wood	\$60.00
 BYF5022F	Posy	4 1/4" H x 4 7/8" L 108mm H x 124mm L	Resin	\$182.00
 BYF5024F	Modern Ball	3 7/8" H x 5 1/4" L 98mm H x 133mm L	Wood	\$116.00
 BYF5025F	Rose	5 3/8" H x 4 7/8" L 135mm H x 125mm L	Resin	\$182.00

## 2 1/8" - 55mm POLES & RINGS

Item Number	Item Name	Dimensions Inches / Metric	Top of Pole to Eyelet	Material	Retail Price Each
 BYSP524F	4' Pole*	47 1/4" L 120cm L		Wood	\$250.00
 BYSP525F	5' Pole*	59" L 150cm L		Wood	\$276.00
 BYSP526F	6' Pole*	70 7/8" L 180cm L		Wood	\$324.00
 BYSP527F	7' Pole*	82 5/8" L 210cm L		Wood	\$422.00
 BYSP528F	8' Pole*	94 1/2" L 240cm L		Wood	\$450.00
 BYR5620F	Ring	3 5/8" OD - 2 5/8" ID 92mm OD - 66mm ID	3 5/8" 92mm	Wood	\$20.00

## WAND

Item Number	Item Name	Dimensions Inches / Metric	Material	Retail Price Each
 BYU9502F	Wand	39 3/5" L 1m L	Wood	\$106.00
 BYU6036F	Wand	36" L 92cm L	Acrylic	\$48.00
 BYU6048F	Wand	48" L 122cm L	Acrylic	\$54.00

\* Advise when splicing poles for longer lengths. Center support brackets required.

Review ACTUAL pole lengths in inches listed above before ordering.

## NEON FINISHES





Matte White 900 Yellow 920 Orange 960 Baby Pink 961 Fuchsia 962  
Raspberry 963 Red 964 Aubergine 970 Navy 971 Turquoise 972 Lime Green 980

\*\*METAL FINISHES: Brass 820 Chrome 840 Antique Brass 830





# NEON FLORAL COLLECTION

2 1/8" - 55 mm

## 2 1/8" - 55mm BRACKETS

Item Number	Item Name	Dimensions Inches / Metric	Projection	Material	Retail Price Each
 BYB5521F	Extended Floral Cup Bracket	3 1/8" Base x 8 3/8" L 80mm Base x 213mm L	6 1/2" 166mm	Wood	\$132.00
 BYB5522F	Double Floral Cup Bracket (35mm/55mm)	3 1/4" Base x 9 1/2" L 82mm Base x 242mm L	3 3/8" - 85mm (BP) 7 1/2" - 190mm (FP)	Wood	\$146.00
 BYB5523F	Inside Mount Bracket	3 7/8" Base x 1 3/4" L 98mm Base x 43mm L	1/4" 6mm	Wood	\$78.00
 BYB5525F	Closed/Ceiling Bracket	3" Base x 6 1/4" L 76mm Base x 158mm L	4 3/8" 111mm	Wood	\$84.00
 BYB5526F	Floral Cup Bracket	3" Base x 6 1/4" L 75mm Base x 160mm L	4 3/8" 110mm	Wood	\$80.00
 BYB5528F	Architrave Bracket	6 3/4" H x 1" Base x 5 1/2" L 170mm H x 26mm Base x 139mm L	3 7/8" 97mm	Wood	\$106.00
 BYB5550F	Invisible Bracket*	3 1/4" H x 1 5/8" Base x 6" L 82mm H x 40mm Base x 152mm L	5 1/2" 140mm	Metal	\$106.00
 BYB5551F	Metal Center Bracket	1 5/8" H x 2 5/8" Base x 4 1/4" L 40mm H x 68mm Base x 107mm L	2 1/2" 64mm	Metal **	\$148.00
 BYB5552F	Metal End Bracket	5 1/2" H x 5/8" Base x 4 1/4" L 140mm H x 16mm Base x 107mm L	2 1/2" 64mm	Metal **	\$148.00
 BYB5562F	Elbow Bracket	2 1/2" Base x 4 1/2" L 65mm Base x 113mm L		Wood	\$120.00

## HOLDBACKS

Item Number	Item Name	Dimensions Inches / Metric	Stem Length	Material	Retail Price Each
 BYH9021F	Classic Holdback	4 3/4" H x 6 1/4" L 120mm H x 159mm L	5 1/2" 140mm	Wood	\$92.00
 BYH9022F	Decorative Holdback	5 1/2" H x 6 7/8" L 140mm H x 175mm L	5 1/2" 140mm	Resin	\$162.00
 BYH9023F	Stepped Holdback	3 3/4" H x 5 1/8" L 95mm H x 130mm L	4" 100mm	Wood	\$92.00
 BYH9024F	French Holdback	3 1/2" H x 7 1/2" L 90mm H x 190mm L	4 3/4" 120mm	Wood	\$132.00

Review ACTUAL pole lengths in inches listed above before ordering.

\*Invisible bracket ONLY available in finish 830 Antique Brass.

Note: Advise when splicing poles for longer lengths. Center support brackets required

### NEON FINISHES





Matte White 900 Yellow 920 Orange 960 Baby Pink 961 Fuchsia 962  
Raspberry 963 Red 964 Aubergine 970 Navy 971 Turquoise 972 Lime Green 980

\*\*METAL FINISHES: Brass 820 Chrome 840 Antique Brass 830







# ROMANTIC FLORAL COLLECTION

1 3/8" - 35 mm

## 1 3/8" - 35mm FINIALS & END CAPS

Item Number	Item Name	Dimensions Inches / Metric	Material	Retail Price Each
 BYF3030F	End Cap	1 3/4" H x 1 1/8" L 46mm H x 28mm L	Wood	\$50.00
 BYF3031F	Daisy	2 1/2" H x 5 1/8" L 62mm H x 130mm L	Resin	\$120.00
 BYF3032F	Posy	3 3/4" H x 4 1/8" L 96mm H x 105mm L	Resin	\$152.00
 BYF3033F	Peony	3 1/4" H x 3 3/8" L 81mm H x 85mm L	Resin	\$120.00
 BYF3034F	Modern Ball	2 7/8" H x 3 7/8" L 72mm H x 100mm L	Wood	\$94.00

## 1 3/8" - 35mm POLES & RINGS

Item Number	Item Name	Dimensions Inches / Metric	Top of Pole to Eyelet	Material	Retail Price Each
 BYSP334F	4' Pole	47 1/4" L 120cm L		Wood	\$166.00
 BYSP335F	5' Pole*	59" L 150cm L		Wood	\$230.00
 BYSP336F	6' Pole*	70 7/8" L 180cm L		Wood	\$250.00
 BYSP337F	7' Pole*	82 5/8" L 210cm L		Wood	\$330.00
 BYSP338F	8' Pole*	94 1/2" L 240cm L		Wood	\$380.00
 BYR3630F	Ring	2 1/2" OD - 1 3/4" ID 65mm OD - 45mm ID	2 3/4" 70mm	Wood	\$14.00

\* Advise when splicing poles for longer lengths. Center support brackets required.

Review ACTUAL pole lengths in inches listed above before ordering.

### ROMANTIC FINISHES













Cream Gold 903    New White 904    Golden Pearl 910    Burnished Gold 921

Antiqued Gold 925    Burnished Silver 945    Dark Pearl 949    Jet Black 952

\*\* METAL FINISHES:    Brass 820    Chrome 840    Antique Brass 830

# ROMANTIC FLORAL COLLECTION

1 3/8" - 35 mm

1 3/8" - 35mm BRACKETS						
Item Number	Item Name	Dimensions Inches / Metric	Projection	Material	Retail Price Each	
 BYB3531F	Extended Floral Cup Bracket	2 1/2" Base x 8 1/8" L 64mm Base x 206mm L	6 3/4" 172mm	Wood	\$80.00	
 BYB3532F	Double Floral Cup Bracket (35mm/35mm)	2 3/8" Base x 9 5/8" L 60mm Base x 244mm L	4 3/4" - 122mm (BP) 8 1/4" - 209mm (FP)	Wood	\$106.00	
 BYB3533F	Inside Mount Bracket	2 1/2" Base x 1 5/8" L 63mm Base x 42mm L	1/4" 6mm	Wood	\$50.00	
 BYB3534F	Double Architrave Bracket (35mm/35mm)	5 7/8" H x 1" Base x 8 7/8" L 150mm H x 26mm Base x 224mm L	3 5/8" - 91mm (BP) 7 1/2" - 191mm (FP)	Wood	\$134.00	
 BYB3535F	Closed/Ceiling Bracket	2 1/4" Base x 5 3/8" L 58mm Base x 136mm L	4 1/8" 105mm	Wood	\$56.00	
 BYB3536F	Floral Cup Bracket	2 1/4" Base x 5 3/8" L 58mm Base x 136mm L	4 1/8" 104mm	Wood	\$54.00	
 BYB3537F	Decorative Architrave Bracket	5 3/4" H x 1" Base x 6" L 146mm H x 26mm Base x 152mm L	3 3/8" 85mm	Wood	\$100.00	
 BYB3538F	Architrave Bracket	6 3/4" H x 1" Base x 5 1/2" L 170mm H x 26mm Base x 139mm L	4 1/8" 105mm	Wood	\$92.00	
 BYB3539F	Ext. Architrave Bracket	5 7/8" H x 1" Base x 8 3/4" L 150mm H x 26mm Base x 222mm L	7 3/8" 187mm	Wood	\$132.00	
 BYB3550F	Invisible Bracket*	3 1/4" H x 1 5/8" Base x 6" L 82mm H x 40mm Base x 152mm L	5 1/2" 140mm	Metal	\$106.00	
 BYB3551F	Metal Center Bracket	1 3/8" H x 2 3/8" Base x 3 5/8" L 35mm H x 60mm Base x 91mm L	2 1/4" 56mm	Metal **	\$126.00	
 BYB3552F	Metal End Bracket	5 3/8" H x 1/2" Base x 3 5/8" L 136mm H x 14mm Base x 91mm L	2 1/4" 56mm	Metal **	\$126.00	
 BYB3563F	Elbow Bracket	1 3/4" Base x 3 3/8" L 45mm Base x 85mm L		Wood	\$116.00	

Review ACTUAL pole lengths in inches listed above before ordering.

\*Invisible bracket ONLY available in finish 830 Antique Brass.

Note: Advise when splicing poles for longer lengths. Center support brackets required

## ROMANTIC FINISHES

Cream Gold 903    New White 904    Golden Pearl 910    Burnished Gold 921







Antiqued Gold 925    Burnished Silver 945    Dark Pearl 949    Jet Black 952

\*\*METAL FINISHES: Brass 820    Chrome 840    Antique Brass 830

# ROMANTIC FLORAL COLLECTION

1 3/4" - 45 mm

1 3/4" - 45mm FINIALS & END CAPS					
Item Number	Item Name	Dimensions Inches / Metric	Material	Retail Price Each	
 BYF4030F	End Cap	2 3/8" H x 1 1/8" L 59mm H x 29mm L	Wood	\$50.00	
 BYF4031F	Daisy	2 3/4" H x 5 3/5" L 70mm H x 142mm L	Resin	\$132.00	
 BYF4032F	Posy	3 3/4" H x 4 1/4" L 96mm H x 108mm L	Resin	\$166.00	
 BYF4033F	Peony	3 3/8" H x 3 3/4" L 86mm H x 95mm L	Resin	\$132.00	
 BYF4034F	Modern Ball	3 3/8" H x 4 7/8" L 85mm H x 125mm L	Wood	\$116.00	
 BYF4035F	Rose	4 3/4" H x 4 3/4" L 122mm H x 122mm L	Resin	\$160.00	

1 3/4" - 45mm POLES & RINGS						
Item Number	Item Name	Dimensions Inches / Metric	Top of Pole to Eyelet	Material	Retail Price Each	
 BYSP434F	4' Pole*	47 1/4" L 120cm L		Wood	\$208.00	
 BYSP435F	5' Pole*	59" L 150cm L		Wood	\$270.00	
 BYSP436F	6' Pole*	70 7/8" L 180cm L		Wood	\$292.00	
 BYSP437F	7' Pole*	82 5/8" L 210cm L		Wood	\$360.00	
 BYSP438F	8' Pole*	94 1/2" L 240cm L		Wood	\$414.00	
 BYR4630F	Ring	3" OD - 2 1/4" ID 77mm OD - 57mm ID	3" 75mm	Wood	\$18.00	

\* Advise when splicing poles for longer lengths. Center support brackets required.

Review ACTUAL pole lengths in inches listed above before ordering.

## ROMANTIC FINISHES













Cream Gold 903    New White 904    Golden Pearl 910    Burnished Gold 921

Antiqued Gold 925    Burnished Silver 945    Dark Pearl 949    Jet Black 952

\*\*METAL FINISHES:    Brass 820    Chrome 840    Antique Brass 830

# ROMANTIC FLORAL COLLECTION

1 3/4" - 45 mm

1 3/4" - 45mm BRACKETS						
Item Number	Item Name	Dimensions Inches / Metric	Projection	Material	Retail Price Each	
 BYB4531F	Extended Floral Cup Bracket	2 7/8" Base x 8 3/4" L 73mm Base x 221mm L	7 1/8" 180mm	Wood	\$88.00	
 BYB4532F	Double Floral Cup Bracket (35mm/45mm)	3 1/4" Base x 9 1/2" L 82mm Base x 242mm L	3 1/4" - 82mm (BP) 7 1/2" - 190mm (FP)	Wood	\$100.00	
 BYB4533F	Inside Mount Bracket	3 1/2" Base x 1 3/4" L 90mm Base x 44mm L	1/4" 6mm	Wood	\$56.00	
 BYB4534F	Double Architrave Bracket (35mm/45mm)	5 7/8" H x 1" Base x 8 7/8" L 150mm H x 26mm Base x 224mm L	3 3/4" - 95mm (BP) 7 3/8" - 187mm (FP)	Wood	\$134.00	
 BYB4535F	Closed/Ceiling Bracket	2 3/4" Base x 6 1/4" L 70mm Base x 160mm L	4 7/8" 123mm	Wood	\$62.00	
 BYB4536F	Floral Cup Bracket	2 5/8" Base x 6 1/8" L 68mm Base x 154mm L	4 7/8" 123mm	Wood	\$58.00	
 BYB4537F	Decorative Architrave Bracket	5 3/4" H x 1" Base x 6" L 146mm H x 26mm Base x 152mm L	3 1/4" 81mm	Wood	\$100.00	
 BYB4538F	Architrave Bracket	6 3/4" H x 1" Base x 5 1/2" L 170mm H x 26mm Base x 139mm L	3 7/8" 97mm	Wood	\$92.00	
 BYB4539F	Ext. Architrave Bracket	5 7/8" H x 1" Base x 8 3/4" L 150mm H x 26mm Base x 222mm L	7 3/8" 187mm	Wood	\$132.00	
 BYB4550F	Invisible Bracket*	3 1/4" H x 1 5/8" Base x 6" L 82mm H x 40mm Base x 152mm L	5 1/2" 140mm	Metal	\$106.00	
 BYB4551F	Metal Center Bracket	1 3/8" H x 2 3/8" Base x 4" L 35mm H x 60mm Base x 100mm L	2 3/8" 60mm	Metal **	\$132.00	
 BYB4552F	Metal End Bracket	5 1/2" H x 1/2" Base x 4" L 136mm H x 14mm Base x 100mm L	2 3/8" 60mm	Metal **	\$132.00	
 BYB4563F	Elbow Bracket	2 1/8" Base x 3 3/4" L 54mm Base x 95mm L		Wood	\$132.00	

Review ACTUAL pole lengths in inches listed above before ordering.

\*Invisible bracket ONLY available in finish 830 Antique Brass.

Note: Advise when splicing poles for longer lengths. Center support brackets required

## ROMANTIC FINISHES

Cream Gold 903    New White 904    Golden Pearl 910    Burnished Gold 921







Antiqued Gold 925    Burnished Silver 945    Dark Pearl 949    Jet Black 952

\*\*METAL FINISHES:    Brass 820    Chrome 840    Antique Brass 830

# ROMANTIC FLORAL COLLECTION

2 1/8" - 55 mm

2 1/8" - 55mm FINIALS & END CAPS					
Item Number	Item Name	Dimensions Inches / Metric	Material	Retail Price Each	
 BYF5030F	End Cap	3" H x 1 1/8" L 76mm H x 28mm L	Wood	\$68.00	
 BYF5032F	Posy	4 1/4" H x 4 7/8" L 108mm H x 124mm L	Resin	\$186.00	
 BYF5034F	Modern Ball	3 7/8" H x 5 1/4" L 98mm H x 133mm L	Wood	\$128.00	
 BYF5035F	Rose	5 3/8" H x 4 7/8" L 135mm H x 125mm L	Resin	\$186.00	

2 1/8" - 55mm POLES & RINGS						
Item Number	Item Name	Dimensions Inches / Metric	Top of Pole to Eyelet	Material	Retail Price Each	
 BYSP534F	4' Pole*	47 1/4" L 120cm L		Wood	\$292.00	
 BYSP535F	5' Pole*	59" L 150cm L		Wood	\$316.00	
 BYSP536F	6' Pole*	70 7/8" L 180cm L		Wood	\$362.00	
 BYSP537F	7' Pole*	82 5/8" L 210cm L		Wood	\$448.00	
 BYSP538F	8' Pole*	94 1/2" L 240cm L		Wood	\$472.00	
 BYR5630F	Ring	3 5/8" OD - 2 5/8" ID 92mm OD - 66mm ID	3 5/8" 92mm	Wood	\$20.00	

\* Advise when splicing poles for longer lengths. Center support brackets required.  
Review ACTUAL pole lengths in inches listed above before ordering.



## ROMANTIC FINISHES

Cream Gold 903    New White 904    Golden Pearl 910    Burnished Gold 921  
Antiqued Gold 925    Burnished Silver 945    Dark Pearl 949    Jet Black 952  
\*\*METAL FINISHES:    Brass 820    Chrome 840    Antique Brass 830



# ROMANTIC FLORAL COLLECTION

2 1/8" - 55 mm

2 1/8" - 55mm BRACKETS						
Item Number	Item Name	Dimensions Inches / Metric	Projection	Material	Retail Price Each Finish A    Finish B	
 BYB5531F	Extended Cup Bracket	3 1/8" Base x 8 3/8" L 80mm Base x 213mm L	6 1/2" 166mm	Wood	\$150.00	
 BYB5532F	Double Cup Bracket (35mm/55mm)	3 1/4" Base x 9 1/2" L 82mm Base x 242mm L	3 3/8" - 85mm (BP) 7 1/2" - 190mm (FP)	Wood	\$152.00	
 BYB5533F	Inside Mount Bracket	3 7/8" Base x 1 3/4" L 98mm Base x 43mm L	1/4" 6mm	Wood	\$86.00	
 BYB5535F	Closed/Ceiling Bracket	3" Base x 6 1/4" L 76mm Base x 158mm L	4 3/8" 111mm	Wood	\$94.00	
 BYB5536F	Floral Cup Bracket	3" Base x 6 1/4" L 75mm Base x 160mm L	4 3/8" 110mm	Wood	\$90.00	
 BYB5538F	Architrave Bracket	6 3/4" H x 1" Base x 5 1/2" L 170mm H x 26mm Base x 139mm L	3 7/8" 97mm	Wood	\$120.00	
 BYB5550F	Invisible Bracket*	3 1/4" H x 1 5/8" Base x 6" L 82mm H x 40mm Base x 152mm L	5 1/2" 140mm	Metal	\$106.00	
 BYB5551F	Metal Center Bracket	1 5/8" H x 2 5/8" Base x 4 1/4" L 40mm H x 68mm Base x 107mm L	2 1/2" 64mm	Metal **	\$148.00	
 BYB5552F	Metal End Bracket	5 1/2" H x 5/8" Base x 4 1/4" L 140mm H x 16mm Base x 107mm L	2 1/2" 64mm	Metal **	\$148.00	
 BYB5563F	Elbow Bracket	2 1/2" Base x 4 1/2" L 65mm Base x 113mm L		Wood	\$142.00	

Review ACTUAL pole lengths in inches listed above before ordering.

\*Invisible bracket ONLY available in finish 830 Antique Brass.

Note: Advise when splicing poles for longer lengths. Center support brackets required

## ROMANTIC FINISHES





Cream Gold 903    New White 904    Golden Pearl 910    Burnished Gold 921

Antiqued Gold 925    Burnished Silver 945    Dark Pearl 949    Jet Black 952



\*\*METAL FINISHES: Brass 820    Chrome 840    Antique Brass 830

# ROMANTIC FLORAL COLLECTION

## HOLDBACKS

Item Number	Item Name	Dimensions Inches / Metric	Projection	Material	Retail Price Each
 BYH9031F	Classic Hold back	4 ¾" Base x 6 ¼" L 120mm Base x 159mm L	5 1/2" 140mm	Wood	\$98.00
 BYH9032F	Decorative Hold back	5 ½" Base x 6 ⅞" L 140mm Base x 175mm L	5 1/2" 140mm	Resin	\$170.00
 BYH9033F	Stepped Hold back	3 ¾" Base x 5 ⅞" L 95mm Base x 130mm L	4" 100mm	Wood	\$98.00
 BYH9034F	French Hold back	3 ½" Base x 7 ½" L 90mm Base x 190mm L	4 3/4" 120mm	Wood	\$140.00

## WAND

Item Number	Item Name	Dimensions Inches / Metric	Material	Retail Price Each
 BYU9503F	Wand	39 ⅝" L 1m L	Wood	\$122.00
 BYU6036F	Wand	36" L 92cm L	Acrylic	\$48.00
 BYU6048F	Wand	48" L 122cm L	Acrylic	\$54.00

\* Advise when splicing poles for longer lengths. Center support brackets required.  
Review ACTUAL pole lengths in inches listed above before ordering.

## ROMANTIC FINISHES

Cream Gold 903    New White 904    Golden Pearl 910    Burnished Gold 921  
Antiqued Gold 925    Burnished Silver 945    Dark Pearl 949    Jet Black 952  
\*\*METAL FINISHES:    Brass 820    Chrome 840    Antique Brass 830

## BESPOKE COLLECTION

### Finish Groups and Colors

Retail Price Finish	Finish
A	Ivory Scratched 901
	Heavily Antiqued White 902
	Antique Cream 905
	Cherrywood 930
	Mahogany 931
	Dark Oak 932
	Chateau Grey 941
B	Red Distressed Gilt 924*
	Antique Gilt 926
	French Grey Antiqued 942
	Florentine Grey 944
	Red Distressed Silver 948*
	Antique Silver 950
	Florentine Black 951
C	Gilt Leaf Mecca 923
	Silver Leaf Mecca 946
	Sand and Silver Distressed 947*

#### RING FINISHES

\* 3 Finishes in our Bespoke collection are NOT offered on the rings due to the fine detailing required to create these finishes. To compliment these finishes, the rings offered for each are as follows: (see page 135 of catalog for images)

- A. Red Distressed Gilt we will supply [Antiquities Gilt Rings](#)
- B. Red Distressed Silver we will supply [Antiquities Silver Rings](#)
- C. Sand & Silver Distressed Gilt we will supply [Silver Leaf Metro Rings](#)

Note: Antiquities Gilt, Antiquities Silver and Silver Leaf Metro are NOT included in our catalog, as these finishes are used on the rings shown in the images. All standard finishes can be found in this catalog.







#### ADDITIONAL BANDING ACCENT CHOICES

BANDING (Bespoke Only)	Gilt (Gold Leaf)
	Silver Leaf
	Satin Black

# BESPOKE COLLECTION

## 1 3/8" - 35 mm

1 3/8" - 35mm FINIALS & END CAPS							
Item Number	Item Name (Banding Code 1 or 2)	Dimensions Inches / Metric	Material	Retail Price Each			
				Finish A	Finish B	Finish C	
 BYF3107F	Aercolaneum <sup>1</sup>	3" H x 4 1/2" L 75mm H x 115mm L	Wood	\$80.00	\$94.00	\$122.00	
 BYF3108F	Artichoke <sup>2</sup>	3 7/8" H x 4 3/4" L 100mm H x 120mm L	Resin	\$130.00	\$152.00	\$200.00	
 BYF3109F	Fluted Ball <sup>2</sup>	3" H x 4 1/2" L 75mm H x 115mm L	Resin	\$130.00	\$152.00	\$200.00	
 BYF3111F	Fluted Button <sup>2</sup>	2 3/4" H x 3 1/8" L 70mm H x 80mm L	Resin	\$130.00	\$152.00	\$200.00	
 BYF3112F	Globe <sup>1</sup>	2 1/2" H x 3 7/8" L 65mm H x 100mm L	Wood	\$80.00	\$94.00	\$122.00	
 BYF3113F	Paestum <sup>1</sup>	2 1/2" H x 4 1/2" L 65mm H x 115mm L	Wood	\$80.00	\$94.00	\$122.00	
 BYF3114F	Pomegranate <sup>2</sup>	2 3/4" H x 4 1/2" L 70mm H x 115mm L	Resin	\$130.00	\$152.00	\$200.00	
 BYF3115F	Pompeii <sup>1</sup>	3 1/2" H x 3 1/2" L 90mm H x 90mm L	Wood	\$80.00	\$94.00	\$122.00	
 BYF3116F	Siena <sup>2</sup>	2" H x 3 1/2" L 52mm H x 90mm L	Resin	\$130.00	\$152.00	\$200.00	
 BYF3117F	Sintra <sup>2</sup>	2 1/8" H x 5 1/8" L 54mm H x 129mm L	Resin	\$130.00	\$152.00	\$200.00	
 BYF3118F	Modern Ball <sup>1</sup>	2 7/8" H x 3 7/8" L 72mm H x 100mm L	Wood	\$80.00	\$94.00	\$122.00	
 BYF3119F	End Cap <sup>1</sup>	2" H x 1 1/8" L 52mm H x 30mm L	Wood	\$40.00	\$48.00	\$62.00	

1 3/8" - 35mm POLES & RINGS							
Item Number	Item Name	Dimensions Inches / Metric	Top of Pole to Eyelet	Material	Retail Price Each		
					Finish A	Finish B	Finish C
 BYSP314F	4' Pole*	47 1/4" L 120cm L		Wood	\$140.00	\$168.00	\$220.00
 BYSP315F	5' Pole*	59" L 150cm L		Wood	\$174.00	\$206.00	\$268.00
 BYSP316F	6' Pole*	70 7/8" L 180cm L		Wood	\$206.00	\$246.00	\$320.00
 BYSP317F	7' Pole*	82 5/8" L 210cm L		Wood	\$244.00	\$292.00	\$378.00
 BYSP318F	8' Pole*	94 1/2" L 240cm L		Wood	\$274.00	\$332.00	\$432.00
 BYR4610F	Ring	3" OD - 2 1/4" ID 77mm OD - 57mm ID	3" 75mm	Wood	\$12.00	\$14.00	\$18.00









(For Information on Banding codes <sup>1&2</sup> see page 54, and Finish Groups A, B & C, see page 47)

\* Advise when splicing poles for longer lengths. Center support brackets required.

Review ACTUAL pole lengths in inches listed above before ordering.

# BESPOKE COLLECTION

1 3/8" - 35 mm

1 3/8" - 35mm BRACKETS								
Item Number	Item Name (Banding Code 1 or 2)	Dimensions Inches / Metric	Projection	Material	Retail Price Each			
					Finish A	Finish B	Finish C	
	BYB3510F Cup Bracket <sup>1</sup>	2 3/8" Base x 6 1/4" L 60mm Base x 160mm L	4 3/4" 120mm	Wood	\$68.00	\$80.00	\$104.00	
	BYB3511F Extended Cup Bracket <sup>1</sup>	2 3/8" Base x 8 5/8" L 60mm Base x 220mm L	7 1/8" 180mm	Wood	\$74.00	\$90.00	\$114.00	
	BYB3512F Double Cup Bracket <sup>1</sup> (35mm/35mm)	2 3/8" Base x 9 5/8" L 60mm Base x 244mm L	4 3/4" - 122mm (BP) 8 1/4" - 209mm (FP)	Wood	\$94.00	\$114.00	\$146.00	
	BYB3513F Inside Mount Bracket	2 1/2" Base x 1 5/8" L 63mm Base x 42mm L	1/4" 6mm	Wood	\$40.00	\$48.00	\$60.00	
	BYB3514F Double Architrave Bracket (35mm/35mm)	5 7/8" H x 1" Base x 8 7/8" L 150mm H x 26mm Base x 224mm L	3 5/8" - 91mm (BP) 7 1/2" - 191mm (FP)	Wood	\$144.00	\$174.00	\$224.00	
	BYB3515F Closed/Ceiling Bracket <sup>1</sup>	2 3/8" Base x 6 1/8" L 60mm Base x 155mm L	4 7/8" 123mm	Wood	\$74.00	\$90.00	\$114.00	
	BYB3518F Architrave Bracket	6 3/4" H x 1" Base x 5 1/2" L 170mm H x 26mm Base x 139mm L	4 1/8" 105mm	Wood	\$94.00	\$112.00	\$144.00	
	BYB3519F Ext. Architrave Bracket	5 7/8" H x 1" Base x 8 3/4" L 150mm H x 26mm Base x 222mm L	7 3/8" 187mm	Wood	\$144.00	\$174.00	\$224.00	
	BYB3550F Invisible Bracket*	3 1/4" H x 1 5/8" Base x 6" L 82mm H x 40mm Base x 152mm L	5 1/2" 140mm	Metal	\$106.00			
	BYB3551F Metal Center Bracket	1 3/8" H x 2 3/8" Base x 3 5/8" L 35mm H x 60mm Base x 91mm L	2 1/4" 56mm	Metal **	\$126.00			
	BYB3552F Metal End Bracket	5 3/8" H x 1/2" Base x 3 5/8" L 136mm H x 14mm Base x 91mm L	2 1/4" 56mm	Metal **	\$126.00			
	BYB3561F Elbow Bracket	1 3/4" Base x 3 3/8" L 45mm Base x 85mm L		Wood	\$124.00	\$138.00	\$162.00	

(For Information on Banding codes <sup>1&2</sup> see page 54, and Finish Groups A, B & C, see page 47)

Review ACTUAL pole lengths in inches listed above before ordering.

\*Invisible bracket ONLY available in finish 830 Antique Brass.





Note: Advise when splicing poles for longer lengths. Center support brackets required

\*\*METAL FINISHES: Brass 820 Chrome 840 Antique Brass 830

# BESPOKE COLLECTION

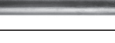
## 1 3/4" - 45 mm

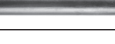
1 3/4" - 45mm FINIALS & END CAPS							
Item Number	Item Name (Banding Code 1 or 2)	Dimensions Inches / Metric	Material	Retail Price Each			
				Finish A	Finish B	Finish C	
 BYF4107F	Aercolaneum <sup>1</sup>	3" H x 5 1/8" L 75mm H x 130mm L	Wood	\$80.00	\$94.00	\$122.00	
 BYF4108F	Artichoke <sup>2</sup>	3 7/8" H x 4 3/4" L 100mm H x 120mm L	Resin	\$130.00	\$152.00	\$200.00	
 BYF4109F	Fluted Ball <sup>2</sup>	3" H x 4 1/2" L 75mm H x 115mm L	Resin	\$130.00	\$152.00	\$200.00	
 BYF4111F	Fluted Button <sup>2</sup>	2 3/4" H x 3 1/8" L 70mm H x 80mm L	Resin	\$130.00	\$152.00	\$200.00	
 BYF4112F	Globe <sup>1</sup>	2 1/2" H x 4 1/2" L 65mm H x 115mm L	Wood	\$80.00	\$94.00	\$122.00	
 BYF4113F	Paestum <sup>1</sup>	2 3/4" H x 5 1/8" L 70mm H x 130mm L	Wood	\$80.00	\$94.00	\$122.00	
 BYF4114F	Pomegranate <sup>2</sup>	2 3/4" H x 4 1/2" L 70mm H x 115mm L	Resin	\$130.00	\$152.00	\$200.00	
 BYF4115F	Pompeii <sup>1</sup>	3 1/2" H x 4 1/8" L 90mm H x 105mm L	Wood	\$80.00	\$94.00	\$122.00	
 BYF4116F	Siena <sup>2</sup>	2 1/3" H x 4 3/8" L 60mm H x 112mm L	Resin	\$160.00	\$194.00	\$252.00	
 BYF4117F	Sintra <sup>2</sup>	2 1/2" H x 6 1/8" L 62mm H x 154mm L	Resin	\$160.00	\$194.00	\$252.00	
 BYF4118F	Modern Ball <sup>1</sup>	3 3/8" H x 4 7/8" L 85mm H x 125mm L	Wood	\$80.00	\$94.00	\$122.00	
 BYF4119F	End Cap <sup>1</sup>	2 1/2" H x 1 1/8" L 65mm H x 28mm L	Wood	\$40.00	\$48.00	\$62.00	

1 3/4" - 45mm POLES & RINGS							
Item Number	Item Name	Dimensions Inches / Metric	Top of Pole to Eyelet	Material	Retail Price Each		
					Finish A	Finish B	Finish C
 BYSP414F	4' Pole*	47 1/4" L 120cm L		Wood	\$200.00	\$236.00	\$306.00
 BYSP415F	5' Pole*	59" L 150cm L		Wood	\$238.00	\$284.00	\$370.00
 BYSP416F	6' Pole*	70 7/8" L 180cm L		Wood	\$272.00	\$332.00	\$426.00
 BYSP417F	7' Pole*	82 5/8" L 210cm L		Wood	\$332.00	\$398.00	\$518.00
 BYSP418F	8' Pole*	94 1/2" L 240cm L		Wood	\$392.00	\$466.00	\$604.00
 BYR4610F	Ring	3" OD - 2 1/4" ID 77mm OD - 57mm ID	3" 75mm	Wood	\$12.00	\$14.00	\$18.00











(For Information on Banding codes <sup>1&2</sup> see page 54, and Finish Groups A, B & C, see page 47)

\* Advise when splicing poles for longer lengths. Center support brackets required.

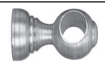
Review ACTUAL pole lengths in inches listed above before ordering.

# BESPOKE COLLECTION

1 3/4" - 45 mm

1 3/4" - 45mm BRACKETS								
Item Number	Item Name (Banding Code 1 or 2)	Dimensions Inches / Metric	Projection	Material	Retail Price Each			
					Finish A	Finish B	Finish C	
 BYB4510F	Cup Bracket <sup>1</sup>	2 7/8" Base x 6 1/2" L 74mm Base x 165mm L	4 5/8" 116mm	Wood	\$74.00	\$88.00	\$114.00	
 BYB4511F	Extended Cup Bracket <sup>1</sup>	3 1/8" Base x 8 5/8" L 80mm Base x 220mm L	7 1/8" 180mm	Wood	\$84.00	\$100.00	\$132.00	
 BYB4512F	Double Cup Bracket <sup>1</sup> (35mm/45mm)	3 1/4" Base x 9 1/2" L 82mm Base x 242mm L	3 1/4" - 82mm (BP) 7 1/2" - 190mm (FP)	Wood	\$118.00	\$140.00	\$182.00	
 BYB4513F	Inside Mount Bracket	3 1/2" Base x 1 3/4" L 90mm Base x 44mm L	1/4" 6mm	Wood	\$52.00	\$58.00	\$78.00	
 BYB4514F	Double Architrave Bracket (35mm/45mm)	7" H x 1" Base x 8 7/8" L 176mm H x 26mm Base x 224mm L	3 3/4" - 95mm (BP) 7 3/8" - 187mm (FP)	Wood	\$144.00	\$172.00	\$224.00	
 BYB4515F	Closed/Ceiling Bracket <sup>1</sup>	2 7/8" Base x 6 1/4" L 74mm Base x 160mm L	4 5/8" 118mm	Wood	\$74.00	\$88.00	\$114.00	
 BYB4518F	Architrave Bracket	6 3/4" H x 1" Base x 5 1/2" L 170mm H x 25mm Base x 139mm L	3 7/8" 97mm	Wood	\$94.00	\$112.00	\$144.00	
 BYB4519F	Ext. Architrave Bracket	5 7/8" H x 1" Base x 8 3/4" L 150mm H x 26mm Base x 222mm L	7 3/8" 187mm	Wood	\$144.00	\$172.00	\$224.00	
 BYB4550F	Invisible Bracket*	3 1/4" H x 1 5/8" Base x 6" L 82mm H x 40mm Base x 152mm L	5 1/2" 140mm	Metal	\$106.00			
 BYB4551F	Metal Center Bracket	1 3/8" H x 2 3/8" Base x 4" L 35mm H x 60mm Base x 100mm L	2 3/8" 60mm	Metal **	\$132.00			
 BYB4552F	Metal End Bracket	5 1/2" H x 1/2" Base x 4" L 136mm H x 14mm Base x 100mm L	2 3/8" 60mm	Metal **	\$132.00			
 BYB4561F	Elbow Bracket	2 1/8" Base x 3 3/4" L 54mm Base x 95mm L		Wood	\$124.00	\$144.00	\$172.00	

(For Information on Banding codes <sup>1&2</sup> see page 54, and Finish Groups A, B & C, see page 47)

Review ACTUAL pole lengths in inches listed above before ordering.

\*Invisible bracket ONLY available in finish 830 Antique Brass.

Note: Advise when splicing poles for longer lengths. Center support brackets required

\*\*METAL FINISHES: Brass 820 Chrome 840 Antique Brass 830







# BESPOKE COLLECTION

2 1/8" - 55 mm



## 2 1/8" - 55mm FINIALS & END CAPS

Item Number	Item Name (Banding Code 1 or 2)	Dimensions Inches / Metric	Material	Retail Price Each		
				Finish A	Finish B	Finish C
 BYF5116F	Siena <sup>2</sup>	2 7/8" H x 5 1/8" L 72mm H x 130mm L	Resin	\$232.00	\$272.00	\$358.00
 BYF5117F	Sintra <sup>2</sup>	3 1/8" H x 7 1/8" L 80mm H x 180mm L	Resin	\$214.00	\$256.00	\$328.00
 BYF5118F	Modern Ball <sup>1</sup>	3 7/8" H x 5 1/4" L 98mm H x 133mm L	Wood	\$166.00	\$200.00	\$260.00
 BYF5119F	End Cap <sup>1</sup>	3" H x 1" L 75mm H x 26mm L	Wood	\$100.00	\$124.00	\$160.00
 BYF5126F	Clandon <sup>1</sup>	4 3/8" H x 7 3/8" L 110mm H x 187mm L	Wood	\$232.00	\$278.00	\$358.00
 BYF5128F	Hardwick <sup>1</sup>	4 1/4" H x 4 3/8" L 108mm H x 110mm L	Wood	\$166.00	\$200.00	\$260.00
 BYF5129F	Heathcote <sup>1</sup>	4 1/8" H x 7" L 105mm H x 177mm L	Wood	\$232.00	\$278.00	\$358.00
 BYF5130F	Alton <sup>1</sup>	4 7/8" H x 5 3/8" L 125mm H x 136mm L		\$232.00	\$278.00	\$358.00

## 2 1/8" - 55mm POLES & RINGS

Item Number	Item Name	Dimensions Inches / Metric	Top of Pole to Eyelet	Material	Retail Price Each		
					Finish A	Finish B	Finish C
 BYSP514F	4' Pole*	47 1/4" L 120cm L		Wood	\$214.00	\$260.00	\$332.00
 BYSP515F	5' Pole*	59" L 150cm L		Wood	\$278.00	\$332.00	\$438.00
 BYSP516F	6' Pole*	70 7/8" L 180cm L		Wood	\$324.00	\$386.00	\$502.00
 BYSP517F	7' Pole	82 5/8" L 210cm L		Wood	\$307.00	\$438.00	\$582.00
 BYSP518F	8' Pole	94 1/2" L 240cm L		Wood	\$426.00	\$502.00	\$662.00
 BYR5610F	Ring	3 5/8" OD - 2 5/8" ID 92mm OD - 66mm ID	3 5/8" 92mm	Wood	\$14.00	\$18.00	\$20.00

## WANDS

Item Number	Item Name	Dimensions Inches / Metric	Material	Retail Price Each		
				Finish A	Finish B	Finish C
 BYU9501F	Wand	39 3/5" L 1m L	Wood	\$100.00	\$116.00	\$150.00
 BYU6036F	Wand	36" L 92cm L	Acrylic	\$48.00		
 BYU6048F	Wand	48" L 122cm L	Acrylic	\$54.00		

(For Information on Banding codes <sup>1&2</sup> see page 54, and Finish Groups A, B & C, see page 47)

\* Advise when splicing poles for longer lengths. Center support brackets required.

Review ACTUAL pole lengths in inches listed above before ordering.

\*\* METAL FINISHES: Brass 820 Chrome 840 Antique Brass 830







## BESPOKE COLLECTION

2 1/8" - 55 mm

### 2 1/8" - 55mm BRACKETS

Item Number	Item Name (Banding Code 1 or 2)	Dimensions Inches / Metric	Projection	Material	Retail Price Each		
					Finish A	Finish B	Finish C
 BYB5510F	Cup Bracket <sup>1</sup>	3 1/8" Base x 6 1/4" L 80mm Base x 160mm L	4 3/4" 110mm	Wood	\$82.00	\$100.00	\$126.00
 BYB5511F	Extended Cup Bracket <sup>1</sup>	3 1/8" Base x 8 3/8" L 80mm Base x 213mm L	6 1/2" 166mm	Wood	\$94.00	\$106.00	\$140.00
 BYB5512F	Double Cup Bracket <sup>1</sup> (35mm/55mm)	3 1/4" Base x 9 1/2" L 82mm Base x 242mm L	3 3/8" - 85mm (BP) 7 1/2" - 190mm (FP)	Wood	\$140.00	\$166.00	\$214.00
 BYB5513F	Inside Mount Bracket	3 7/8" Base x 1 3/4" L 98mm Base x 43mm L	1/4" 6mm	Wood	\$58.00	\$68.00	\$88.00
 BYB5514F	Double Architrave Bracket (35mm/55mm)	6 7/8" H x 1" Base x 10 1/4" L 176mm H x 26mm Base x 261mm L	4 3/8" - 112mm (BP) 8 5/8" - 218mm (FP)	Wood	\$214.00	\$252.00	\$332.00
 BYB5515F	Closed/Ceiling Bracket <sup>1</sup>	3" Base x 6 1/8" L 76mm Base x 155mm L	4 3/8" 110mm	Wood	\$82.00	\$100.00	\$126.00
 BYB5518F	Architrave Bracket	6 3/4" H x 1" Base x 5 1/2" L 170mm H x 26mm Base x 139mm L	3 7/8" 97mm	Wood	\$94.00	\$106.00	\$140.00
 BYB5519F	Ext. Architrave Bracket	5 7/8" H x 1" Base x 8 3/4" L 150mm H x 26mm Base x 222mm L	7 3/8" 187mm	Wood	\$214.00	\$252.00	\$332.00
 BYB5550F	Invisible Bracket*	3 1/4" H x 1 5/8" Base x 6" L 82mm H x 40mm Base x 152mm L	5 1/2" 140mm	Metal	\$106.00		
 BYB5551F	Metal Center Bracket	1 5/8" H x 2 5/8" Base x 4 1/4" L 40mm H x 68mm Base x 107mm L	2 1/2" 64mm	Metal **	\$148.00		
 BYB5552F	Metal End Bracket	5 1/2" H x 5/8" Base x 4 1/4" L 140mm H x 16mm Base x 107mm L	2 1/2" 64mm	Metal **	\$148.00		
 BYB5561F	Elbow Bracket	2 1/2" Base x 4 1/2" L 65mm Base x 113mm L		Wood	\$132.00	\$172.00	\$200.00

### HOLDBACKS

Item Number	Item Name (Banding Code 1 or 2)	Dimensions Inches / Metric	Stem Length	Material	Retail Price Each		
					Finish A	Finish B	Finish C
 BYH9014F	Model O (French) Hold Back <sup>1</sup>	3 1/2" H x 7 1/2" L 90mm H x 190mm L	4 3/4" 120mm	Wood	\$126.00	\$146.00	\$174.00
 BYH9015F	Model M (Rd Acanthus Leaf) <sup>1</sup> Hold Back	5 5/8" H x 6 7/8" L 140mm H x 175mm L	5 1/2" 140mm	Resin	\$174.00	\$200.00	\$238.00
 BYH9016F	Model A <sup>1</sup> Hold Back	4 3/4" H x 6 1/4" L 120mm H x 160mm L	5 1/2" 140mm	Wood	\$114.00	\$134.00	\$160.00
 BYH9017F	Model L <sup>1</sup> Hold Back	5 7/8" H x 7 1/8" L 150mm H x 180mm L	5 1/2" 140mm	Wood	\$174.00	\$200.00	\$238.00

(For Information on Banding codes <sup>1&2</sup> see page 54, and Finish Groups A, B & C, see page 47)

Review ACTUAL pole lengths in inches listed above before ordering.

\*Invisible bracket ONLY available in finish 830 Antique Brass.

Note: Advise when splicing poles for longer lengths. Center support brackets required

\*\*METAL FINISHES: Brass 820 Chrome 840 Antique Brass 830

# BESPOKE COLLECTION

## BANDING

Banding can be applied to enhance the overall look of a product and or window treatment by highlighting details to complement surrounding hardware, decor and soft furnishings.

See page 61 for additional information.

THE FOLLOWING ARE OUTLINES OF THE ITEMS THAT CAN BE BANDED.  
THE LETTER ILLUSTRATES THE AREA THAT CAN BE CHOSEN TO BAND.

Banding is available in Gilt, Silver and Black finishes only.

BANDING IS CHARGED BY THE ITEM,  
NOT BY THE NUMBER OF BANDS SELECTED.

Bracket Banding Charges - Retail

Band Code	35mm	45mm	55mm	Price
1*	BYB3510F	BYB4510F	BYB5510F	\$30.00
	BYB3511F	BYB4511F	BYB5511F	\$30.00
	BYB3512F	BYB4512F	BYB5512F	\$30.00
	BYB3515F	BYB4515F	BYB5515F	\$30.00

Finial & Holdback Banding Charges - Retail

Band Code	35mm	45mm	55mm	Holdback
1*	\$34.00	\$38.00	\$80.00	\$38.00
2*	\$50.00	\$50.00	\$100.00	n/a

\* See Code # next to Item Name  
on pricing pages

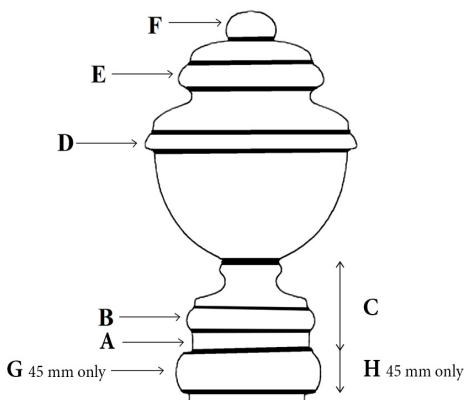

AERCOLANEUM

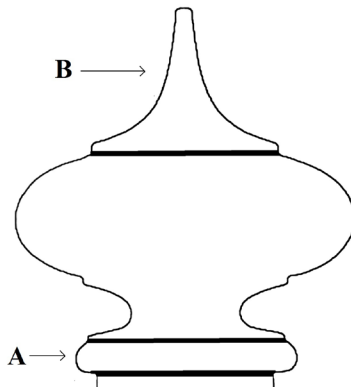

ALTON

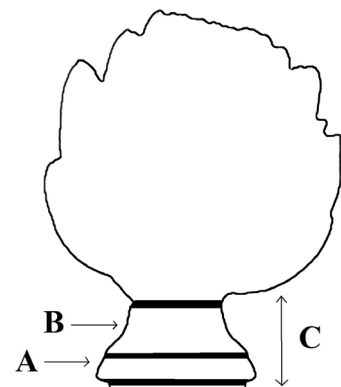

ARTICHOKE

BESPOKE COLLECTION

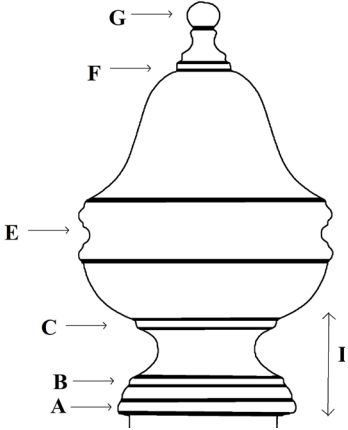

CLANDON

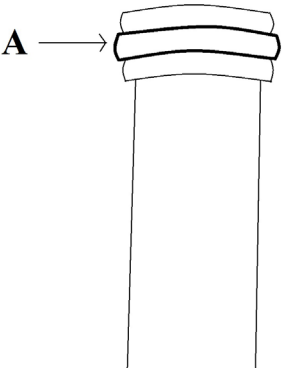

END CAP

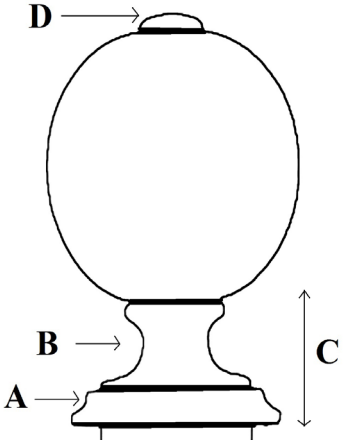

FLUTED BALL

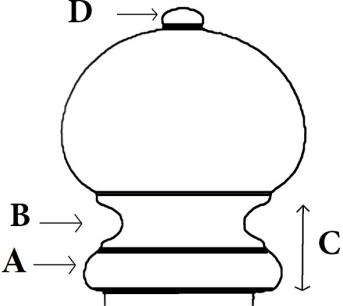

FLUTED BUTTON

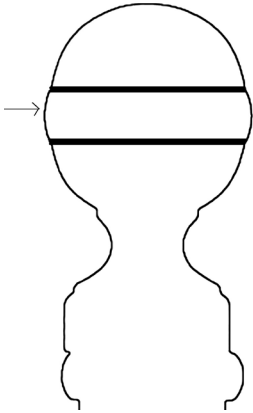

GLOBE

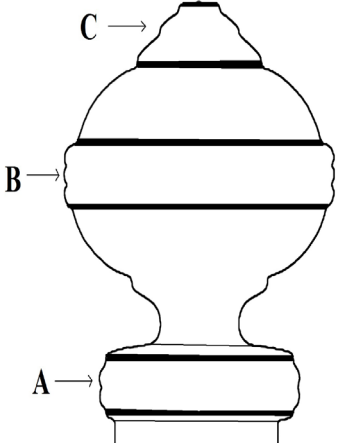

HARDWICK

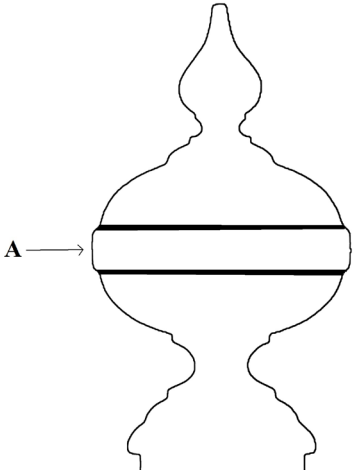

HEATHCOTE

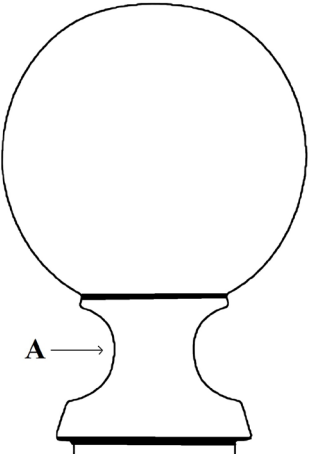

MODERN

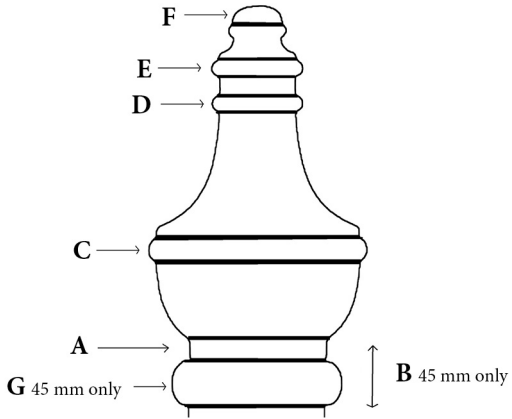

PAESTUM

BESPOKE COLLECTION

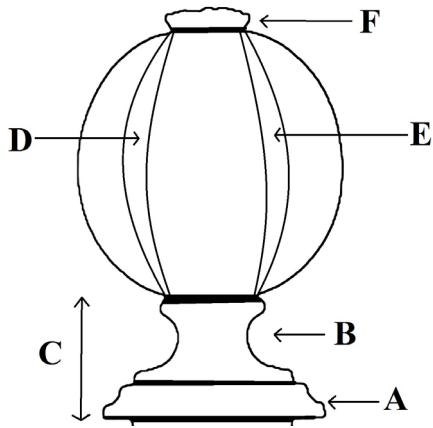

POMEGRANATE

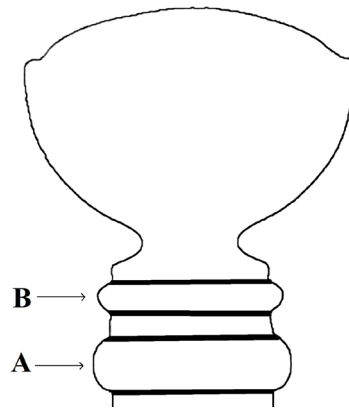

(A - 45mm only)

POMPEII

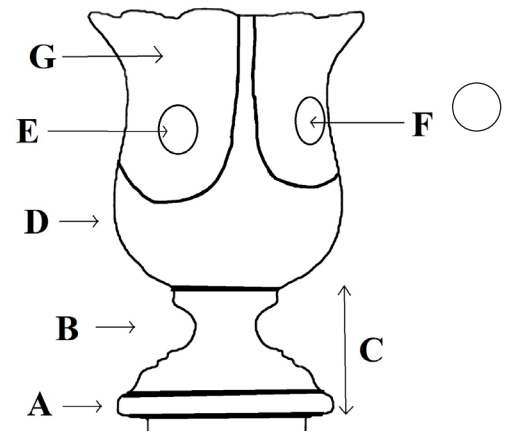

SIENA

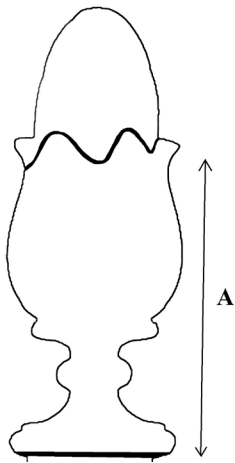

SINTRA

# BESPOKE COLLECTION

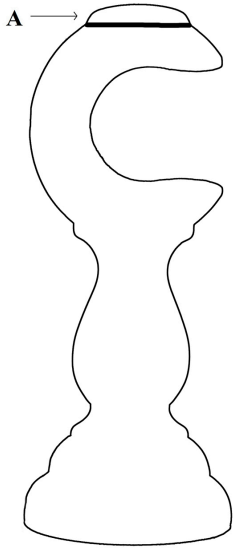

CUP BRACKET &  
EXTENDED CUP BRACKET

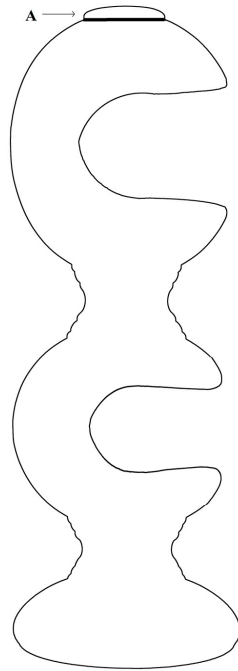

DOUBLE CUP BRACKET

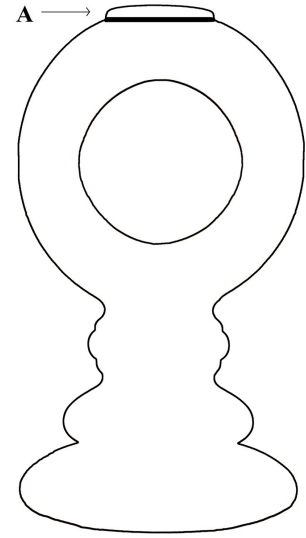

CLOSED/CEILING  
BRACKET

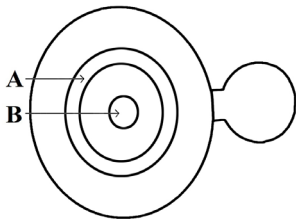

MODEL A  
HOLDBACK

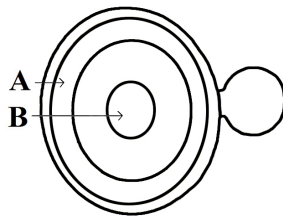

MODEL L  
HOLDBACK

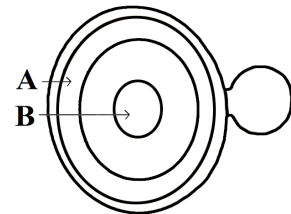

MODEL M  
HOLDBACK

MODEL O  
HOLDBACK

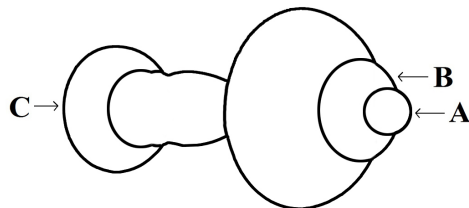

# GENERAL TERMS, CONDITIONS AND PRODUCT INFORMATION

## ORDERS

---

Orders may be received via email, fax or internet. Verbal orders will not be accepted. Incomplete information will delay order processing and shipping.

Fabricut Hardware Customer Service  
PHONE: 800.763.1348  
FAX: 918.392.6085  
EMAIL: HARDWARE@FABRICUT.COM  
WEBSITE: WWW.FABRICUT.COM

## LEAD TIME & RUSH ORDERS

---

**Lead time:** Orders require approximately 15 BUSINESS DAYS for production time. This does not include shipping time. Orders are typically received in 2-3 weeks.

**Rush Orders:** Rush orders may be available upon request and must be approved by Byron & Byron. Additional charges may be included on a "per order" basis.

## PAYMENT

---

Payment terms are Net 30, Cash on Delivery (COD) or Proforma (CBD). Credit cards accepted are Visa, Mastercard, Discover and American Express. A \$25 fee will be charged for any returned checks.

## PRICES & SHIPPING

---

Prices are subject to change without notice. Typographical errors are subject to correction. Prices do not include shipping, handling and special processing charges which are additional charges.

All Byron & Byron product is designed in the United Kingdom. Orders ship via UPS Ground from Dallas, Texas. An additional surcharge over commercial rate will be billed for residential delivery.

## CANCELLATIONS & RETURNS

---

All of our items are made to order and are produced individually for each order. Consequently, cancellations, changes and returns are not permitted once an order is processed.

## DAMAGED GOODS

---

It is recommended that you inspect your entire order upon delivery. Any claim for damaged merchandise must be made with the shipping company within 15 days of receipt. No claims after 15 days will be accepted. When making a claim, please keep all packing materials, as claims may require inspection of these materials.

## INSTALLATION

---

Molly bolts and anchors are recommended for all installations but are not included. Support brackets are recommended every 3-4 feet (every 3-feet for acrylic poles). An experienced professional installer will be able to determine where support is necessary. It is strongly recommended that experienced professional installers are used for your installation.

## INSTALLATION HARDWARE

---

Installation hardware, such as screws, molly bolts, etc., are NOT included with orders.

## PRODUCT INFORMATION

---

As these are hand made pieces, variations from photographs, samples and prior orders may occur. It is recommended that orders for a single room be placed at the same time, for dye lots to match.

Wood items may vary slightly in size due to the nature of the materials and production process.

# GENERAL TERMS, CONDITIONS AND PRODUCT INFORMATION

## NOTES WHEN ORDERING:

### FINISHES

---

**Finishes are NOT interchangeable between collections.**

All finishes are produced by hand. Dye lots will vary.

There are no specific repeats or “patterns” to any finish. Coverage will vary from piece to piece, order to order. There may be heavier or lighter coverage on each piece and throughout a single piece. This is the “nature” of the technique and finish.

**Resin Finials, Holdbacks and Brackets CANNOT be stained.** Resin can be painted to “look like / imitate” stain. They can be painted to “match” the stain color as closely as possible. But exact color matches are NOT guaranteed as different techniques (Painting vs Staining), are being applied to different materials (Resin vs Wood).

**Metal Brackets CANNOT be stained or painted.** They are available ONLY in the finishes shown/specified in the catalog and price list.

**Custom Finish:** Custom finishes are available with any Byron & Byron collection. Finishes are matched up to 95% accuracy. A strike-off sample is available upon request for \$70. Lead time begins upon approval of strike-off. Fee is 10% of order value, with a minimum of \$100 per order.

### SAMPLE CHIP FINISHES

---

**Sample Chip Finishes:** Byron & Byron sample chips are a representation of the finish. Due to the nature of the materials and the hand painted technique, acceptable variations will occur from sample chip to sample chip. These same acceptable variations can occur from sample chip to actual finished product.

### POLES

---

**Ordering:** Poles can be cut to your required length at no additional charge. No returns accepted on any poles that have been cut.

**Splicing/Joining:** If you intend to splice / join poles together for extended lengths, you must specify this on your order so that they are finished and drilled for the proper application. Splicing screws will be included ONLY if you specify this application. Additional brackets will be required to support the expanse and the splicing joint.

### PACKAGING FEE

---

A packaging fee of \$10 (net) will apply to any order that has a pole.

# GENERAL TERMS, CONDITIONS AND PRODUCT INFORMATION



## HALO POLES

---

**Pole Size:** Poles are available in the following 3 diameters: 1 3/8" / 35mm, 1 3/4" / 45mm & 2 1/8" / 55mm.

Acrylic poles are available in 2 lengths: 6 1/2' / 200 cm and 8 1/8' / 244cm.

Acrylic poles are available in one continuous piece up to the length of 96 1/8" / 244cm.

All other poles are available in up to 5 lengths (see pricing section for specific lengths) with a maximum length of 94 1/2" / 240cm. NOTE - Actual lengths are all not in full feet. Read dimensions carefully.

All poles can be cut to your required length at no additional charge. No returns accepted on any poles that have been cut.

We strongly recommend that acrylic poles be cut by Byron & Byron.

Should you choose to cut down the Acrylic pole yourself, please note that the blade will need to be cooled down when cutting the pole as it can become very hot and subsequently melt or mar the pole.

No returns or cancellations accepted on any poles that have been cut.

**Splicing/Joining:** A pilot hole must be made in the poles before screwing the brackets to the pole. Your installer should use a clean and sharp 3mm drill bit that is appropriate for acrylic.

A Joining Bracket is required in place of a joining / splicing screw for all Halo acrylic installations.

**Weight Restrictions:** There are certain weight restrictions applicable for each diameter of the Halo acrylic poles.

1 3/8" - 35mm Dia	7 to 10 lbs per yard.
1 3/4" - 45mm Dia	12 lbs per yard.
2 1/8" - 55mm Dia	12 lbs per yard.



**Easy Glide Tape should not be applied to the acrylic poles.** The Halo Metal and Passing rings have a silicon strip around the inner circumference of the ring to ease the gliding of the rings on the poles.

## EASY GLIDE TAPE (For use on Wood poles)

---

**Easy Glide Tape can be ordered with every wood pole order at NO Charge. Easy Glide Tape should not be applied to acrylic poles,** as it may be visible through the pole and will not be included in orders for acrylic poles. Easy Glide Tape provides a slick surface for drapery rings to easily glide over a drapery pole.

## BRACKETS

---

Use a support bracket for any pole in excess of 4 feet. We do not guarantee against sagging caused by unsupported spans over 4 feet. (3 feet for acrylic poles).

End and Center Metal Brackets Available in Brass, Chrome and Antique Brass only. They are NOT compatible with the following finials:

Neon: 45mm ROSE, 55mm ROSE  
Romantic: 45mm ROSE, 55mm ROSE  
Bespoke: 55mm Alton

Invisible Brackets are available in Antique Brass ONLY





# GENERAL TERMS, CONDITIONS AND PRODUCT INFORMATION

## RINGS

---

A typical installation calls for 3-4 rings per pole foot length. Consult your design professional for your specific project requirements.

## HALO RINGS

Standard rings are available in Acrylic, Chrome, Burnished Brass and Copper.

Passing Rings only available in Chrome, Burnished Brass and Copper. All metal rings are lined with a silicon strip.

For poles requiring passing brackets and rings, the 2 rings positioned on the ends of the poles between the bracket and finial must be standard rings and not passing rings to prevent the rings from sliding over the end brackets.

## ADAPTORS - BESPOKE ONLY

---

Adaptor bases are used with the following 35mm finials to "adapt" to 45mm poles:

1. Aercolaneum
2. Paestum
3. Pompeii
4. Globe

They are automatically included with your order when you order the 45mm finial. Please be sure that your installer is aware of this so they are not inadvertently thrown away.

## BANDING - BESPOKE ONLY

---

Banding is offered in 3 colors; GILT, SILVER and BLACK. They may NOT be mixed on a piece. Accent banding in gilt, silver and black is available as an ADDITIONAL finish on certain BESPOKE finials, brackets and holdbacks to enhance the overall look of the product. Refer to the catalog to identify areas where the "banding" can be applied. **Banding will not be applied unless specified on your order, regardless of photography in the catalog.** In the catalog, they are identified as, "with banding", which is considered ADDITIONAL and must be specified on your order.

In your order, specify the color and specific areas where you want the banding to be added. You may select any combination of the specified areas for banding, for example: "A + C" or "A + B + C" or "C only". Banding is not available in any areas NOT specified in the drawings. Charges for banding can be found in the pricelist. They are identified with a 1 or 2 in the pricelist for the price level. Pricing is per piece, not per area.

# BYRON & BYRON PRODUCT AND FINISH MANUAL

## GILT & SILVER FINISHES<sup>1</sup>:

### GILDING

---

All of Byron & Byron's gilt and silver finishes are produced using real metal leaf, not gold paint. Why do it this way? Because this is the classical method, and it is the only way to get a proper gold or silver color without it being too dull or too green.

### WHAT IS METAL LEAF?

---

Metal Leaf is a special type of gilding which uses a gold colored metal leaf, flattened and hammered down extremely thinly. This leaf is then applied to a prepared surface using a "size" (a kind of glue). Once it has been laid on the sized surface, the leaf is burnished using a burnishing tool or is buffed using special wool cloth (to get a more matte finish). Then the surface can either be fixed or it can be distressed to reveal the color of the substrate onto which the leaf has been applied.

In the old days, surfaces would have been leafed to make them look like solid gold or solid silver, but with the passing of time and with the rubbing of hands, the leaf would have worn out or, as described now, would be "distressed". So, when a newly laid metal leafed surface is distressed, what is being done is creating the illusion of the wearing of time.

Byron & Byron is constantly looking for something new, and has also been applying the distressing in less subtle ways in order to achieve more striking looks and even very modern color textures.

### PATINA IS THE NEXT STEP

---

Time doesn't only wear down the leaf, but it gives it a patina. What is a patina? A patina is a pigmented mixture of contrasting color to the leaf or the paint, which is applied to the gilded or painted surface to highlight the narrow lines of the turning or of the carving, thus accentuating the three-dimensional effect of the finished item.

One of the most widely used patinas (now as 1000 years ago) is bitumen, which is a derivate of crude oil (yes road tarmac). First used during the height of the Byzantine Era, it was brought to the west by the Venetian traders. What the Venetian craftsmen realized was that they could silver leaf and, then by applying bitumen cleverly, could make it look very similar to a gilt surface without the expense! From that point on bitumen became the "King of Patinas" for it could turn silver into gold!!

Byron & Byron also uses bitumen, but has developed several new ways of aging the leafed or painted surfaces. With the advent of acrylic paints (which are far kinder to the leafed surface) some brilliant results have been produced, without substantially chemically changing the leaf. Emulsion wax compounds are used, as well, which are water based and to which pigments are added to get the specific shading to match the painted surface. For example, this is what is used for the scratch & antiqued French colors.

### CARING FOR GILDED SURFACES

---

Metal leafed poles and finials need specific care. Once installed, they should only be dusted. They should never be polished nor should water based or wax based compounds be used on their surfaces.

Time will age the surface and there will be some wearing, especially on the side of the pole that faces the ceiling. This will be caused by the movement of the rings. This is not a defect, but it is the way it has always been. From time to time, especially in the early stage of the pole life, there will be some shedding of small particles of gold/silver leaf. This is normal since even the gilt rings are leafed! As they move across the pole, they shed some of the inner leaf. [Of course, this problem can be completely eliminated by painting the rings instead of leafing them (which is what most competitors do!!), but this way of finishing, it will not look anything like the rest of the pole and the finials. So it is a very small evil that is worth putting up with for the sake of aesthetics.] This shedding will end in a short period of time.

---

<sup>1</sup> Finishes Include: Gilt Leaf Mecca, Silver Leaf Mecca, Florentine Grey and Florentine Black

# BYRON & BYRON PRODUCT AND FINISH MANUAL

## THE VALUE OF A HAND GILT POLE ORDER

---

On average, a Red Distressed Pole and its accessories will need to be handled about 13 times! Yes 13 times! Besides the very important leafing and distressing actions, there is a lengthy preparation of the surface, which will determine the quality of the end result, and there is a lengthy finishing routine during which some more modern finishing is applied to the gilt surface to seal it and make it stable for years to come. The majority of the work must be done by experienced craftsmen who apply their years of training onto each and every piece. **In short, the next best thing to a Byron & Byron pole is an antique pole, which, if you could find it in the color, the size, and the design you want, would cost several times more than what we charge!** Byron & Byron poles are the antiques of the future! They will withstand the passing of time.

## ANTIQUED FRENCH COLORS & DISTRESSED PAINT FINISHES (SCRATCHED) <sup>2</sup>:

This range of finishes is intended to reproduce some of the most exquisite painted finishes typical of the Versailles Period. The look has been modernized and made fresher, more elegant and easier to use within some classical Interiors as well as some more contemporary ones.

Byron & Byron has tried to capture the taste of Provence- its light and elegant simplicity, its colors and textures.

## WHAT IS THE FINISHING PROCESS?

---

The process in itself is quite simple and less complicated than the gilding process. However, certain precautions have to be implemented as the attention to detail is what makes these finishes more than just colored paint slapped onto wood. This is done by using water based lime wash paints (which is what was used in those days). The distressing is achieved by buffing and abrasion, using some natural compounds. Any gilt or silver highlights are then applied.

Once the surface has been distressed and the details applied, it is fixed using a suitable clear lacquer. Then the surface is finished with a Patina made of wax emulsion pigmented accordingly. After the patina has been applied and it has dried, it is buffed and distressed further to make sure that the surface is as three-dimensional as possible. Once this has been done, the object is again fixed, to ensure its durability.

## CARING FOR PAINTED SURFACES <sup>3</sup>

---

Painted surfaces are more durable and are far easier to maintain than gilt surfaces. The main enemy of a painted surface is dampness. As long as they are in a reasonably dry environment and no chemical cleaning agents are used, they will last for a long time.

---

<sup>2</sup> Bespoke finishes include: Antique Silver, Antique Gilt, Red Distressed Gilt, Red Distressed Silver, Sand & Silver Distressed, Ivory Scratched, Stripped Pine

Rustica finishes include: Limed Oak, Smoked Oak, Toasted Oak, Burnt Oak

Barnwood finishes include: Barnwood Grey, Barnwood White, Barnwood Green, Barnwood Cream

<sup>3</sup> Bespoke painted finishes include: Chateau Grey, Antique Cream, French Grey Antiqued, Heavily Antiqued White

Barnwood finishes include: Dove Grey, Natural Stone, Moss Green, Calico

Neon finishes include: Yellow, Turquoise, Fuschia, Red, Orange, Lime Green, Baby Pink, Raspberry, Aubergine, Matte White, Navy

Romantic finishes include: Antiqued Gold, Burnished Gold, Golden Pearl, Jet Black, Burnished Silver, Dark Pearl, New White, Cream Gold

# BYRON & BYRON PRODUCT AND FINISH MANUAL



## POLISHED FINISHES <sup>4</sup>:

Byron & Byron's polished poles are their pride and joy. These superior products would normally be available only through specialist polishers at a far greater cost. The look of French polished furniture has been reproduced by using more modern products and techniques. However, we have not moved away from the fundamentals.

### WHY ARE BYRON & BYRON'S POLISHED FINISHES SO UNIQUE?

---

Thousands of years ago, the Chinese used to dissolve in alcohol the shells of some local beetles (in time, this compound came to be called LACACOTE). They would use this "compound" to polish the surface of furniture and cutlery. The "compound" mixed with a vegetable oil would be applied to slow down the drying process and allow them to spread the polish on the surface in a very even manner. By repeating this process several times, they managed to achieve "glass like" surfaces. Sometime in the Middle Ages, this technique reached the west and furniture makers were liberated from the constriction of wax as the only viable finishing material. It was at this point that more elegant and durable furniture began to be produced.

What Byron & Byron uses is a modern high build compound to achieve the smooth surface thus eliminating the killing of Lacacote beetles. These are cellulose based compounds which are not catalysed so they display very similar characteristics to the old lacacote polishes. The top uses a special polish, tinted to resemble the lacacote lacca and this adds the sheen level that would be accurate with a proper French polished furniture (Lacacote finishing as is known today).

Although the polishes used are different from the past, the process of application has not changed much. The lacca is applied by airless spray; however, between each coat Byron & Byron buffs and polishes, just like was done in China long ago. That is why, only very few experts would notice the difference between a Byron & Byron polished piece and proper French polishing.

### STAINING IS IMPORTANT TOO

---

The staining of the wood components is just as important as the polishing of them. Water based stains are still used, so that the graining of the wood is enhanced. Water staining has a transparency that is not possible with any other modern staining method. Of course, it takes longer, and the pigments are expensive. But the end result is outstanding and makes it worth while.

While Byron & Byron calls their finishes "Mahogany" or "Cherry Wood" it does not mean that the products are made of these exotic and precious woods. For example it would be virtually impossible to buy long lengths of cherry to make poles in required quantities, or to make rings out of mahogany, for they would be very fragile and could easily snap.

To create this look, various components that make up an order are used, in the timbers most suited for the turning or the milling and then each component is stained accordingly so that, once put together, they will match or blend together in an harmonious way, resembling the woods from which they take the name. Wood is a natural product; it has its imperfections and its shades of natural colours. These details are what make natural wood what it is. No two pieces of wood are exactly the same and therefore differences in color or graining are part of the charm of the products. Thus, variations can occur from the color samples on the displays.

### CARING OF POLISHED SURFACES

---

Byron & Byron polished poles have a very stable surface. Any wax based furniture polish can be used to clean and revive the poles, except if they contain gilt or silver details. When gilt or silver details are present, the poles should be cleaned only with a soft cloth.



---

<sup>4</sup>Bespoke Polished Finishes Include: Dark Oak, Cherrywood, Mahogany  
Rustica Finishes Include: English Oak

## RESIN FINIALS, BRACKETS AND HOLDBACKS <sup>5</sup>:

---

The more decorative finials, brackets and holdbacks are cast in resin-- not just any resin, but a special type!

### WHY USE RESIN WHEN YOU COULD USE WOOD?

---

Simply, over the years fewer and fewer people are willing to undertake the long apprentice necessary to become a master wood carver. Therefore, woodcarving is a dying art and we have developed superior resin castings to simulate wood carving.

While resin, as a casting medium, has been widely available for a number of decades, the results that were yielded out of the molds were poor. The details were not very sharp, the material was very brittle and the weight difference from a wooden item was colossal (most of these problems were due to the Gypsum Filler used with the polyester). After many years of development, Byron & Byron developed a resin which is loaded with wood saw dust as its main filler. This has enabled the creation of pieces with a wood feel, good resolution of the details, slight flexibility like wood and a very wood-like weight! This is why resin is used instead of wood.

With regard to the finishes, similar methods are used as would be employed with real wood products. When re-creating the stained finishes, painting techniques are employed to allow the resin finials come as close to matching the poles as possible. Like natural woods that will have slight variations from piece to piece, so will the resins.

### CARING FOR RESIN FINIALS & ACCESSORIES

---

Resin castings are delicate. While they have many qualities of wood, they do not have its strength. We therefore recommend the following:

- Screw the double ended screw into the pole first and then, when the screw is in far enough, screw the finial onto it. Do not use a resin finial to help insert a double ended screw at the end of a pole.
- The finials are fragile (especially the neck of the finial). Care must be taken. Do not drop them.
- Avoid washing any of the resin components with highly volatile solvents as it will affect the surface of the item.

### CARING FOR HALO

---

Both Acrylic and Metal products need specific care. Once installed, they should only be dusted with a feather duster or dry cloth. They should never be polished nor should water based or wax based compounds be used on their surfaces. Washed Wood and Gloss finishes should be treated the same way. DUSTED ONLY.

The Halo pole installations with acrylic components should not be exposed to direct sun light.

---

<sup>5</sup>Resin Bespoke finials include: Siena, Sintra, Pomegranate, Fluted Ball, Artichoke, Fluted Button  
Resin Holdbacks include: Model I, Model L  
Resin Floral Finials include: Daisy, Rose, Posy, Peony

NOTES:



NOTES:



# FABRICUT<sup>®</sup>

P. O. BOX 470490 • TULSA, OKLAHOMA 74147-0490

PH: 800.763.1348 • FAX: 918.392.6085

FABRICUT.COM