



South Australia Payment Region

Milk Supply Agreement – Non-Exclusive

31 May 2022

IMPORTANT INFORMATION

- A. This Milk Supply Agreement (**MSA**) outlines the terms and conditions upon which you agree to supply milk to Lactalis Australia Pty Ltd. If you are uncertain about any of the terms of this standard MSA you should firstly speak to your Supplier Relationship Manager. You should also obtain independent legal, accounting and business advice about the terms of this MSA and, in particular, the consequences of not meeting your obligations under this MSA. When you sign this MSA, you confirm that you understand all aspects of this MSA.
- B. You have 14 days after the day that this MSA is entered into to change your mind and terminate this MSA with immediate effect without incurring any liability to us (cooling-off period).

SCHEDULE A - DETAILS

Lactalis: Lactalis Australia Pty Ltd ABN 56 072 928 879
Level 5, 35 Boundary Street, South Brisbane, Qld 4101
Email: farmpayments@au.lactalis.com

Supplier:

Full name of legal entity of the Supplier: <i>(If the Supplier is a trustee of a trust, include name of trustee (and ACN if corporate trustee), and name of trust)</i>	
ABN: <i>(If the Supplier is a trustee of a trust, include the ABN of the trust)</i>	
Farm number:	
Address (for documents to be sent to the Supplier):	
Farm address (for Milk collection if different to address for documents):	
Email:	
Phone:	

SCHEDULE B – KEY TERMS

1. Supply Period

You will supply us with Milk in accordance with the terms of this MSA for the Supply Period which:

- (a) commences on 1 July 2022 or the date after 1 July 2022 on which we first collect Milk from your Farm (**Commencement Date**); and
- (b) ends on 30 June 2023 (**End Date**).

2. Non-Exclusive supply

You will supply us with Milk on a non-exclusive basis. You commit to supply us with the monthly volumes of Milk during the Supply Period that you nominate in the table below.

Month	Committed Monthly Volume (Enter volume in litres)
July	
August	
September	
October	
November	
December	
January	
February	
March	
April	
May	
June	

3. Minimum Price

The Minimum Price for the Supply Period is the lowest price payable for Milk under this MSA disregarding any:

- (a) loyalty payment;
- (b) possibility of a temporary reduction in price in accordance with section 28 of the Dairy Code; and
- (c) fees payable by you under the MSA.

We will not decrease the Minimum Price during the Supply Period except in the circumstances allowed for by the Dairy Code. However, we may increase the Minimum Price during the Supply Period.

3.1 Justification for Minimum Price

The Dairy Code requires us to include in our standard published MSA justification for our Minimum Price. The factors that we have considered when setting our Minimum Price are:

- (a) our cost of production;
- (b) the anticipated milk production forecast for the region;
- (c) the product mix and markets that the region supplies;
- (d) competition for milk across the region;
- (e) international dairy markets, i.e. the price of milk in international regions plus freight to Australia;
- (f) any volume or productivity adjustments reflecting the efficiency of collecting from large farms as opposed to the cost of collecting from a larger number of smaller farms;
- (g) seasonal adjustments to take into account the variation in supply and cost of milk production; and
- (h) farm input costs.

3.2 Minimum Price calculation

We calculate the Minimum Price that we will pay you for Milk that you supply in each month of the Supply Period in accordance with the following formula:

$$\text{Minimum Price} = \text{Base Rate} + \text{Volume Adjustment} + \text{Tenure Adjustment} + \text{Proximity Adjustment (if applicable)} - \text{Deductions (if applicable)}$$

Where:

Base Rate means the Base Rate for Milk which is comprised of the milk fat payment and protein payment calculated in accordance with the table below, plus or minus the Quality Requirement Adjustments*.

Applicable months	\$/Kg of milk fat supplied in the month	\$/Kg of protein supplied in the month
July	7.08	10.62
August	6.04	9.06
September - November	5.33	8.00
December - January	6.04	9.06
February – June	7.08	10.62

**Quality Requirement Adjustments* means the applicable adjustments as set out in the table below and further described in section 2.6 of the Handbook.

BMCC Test Result cells/mL	Adjustment to Base Rate	Bactoscan Test Result IBC/mL	Adjustment to Base Rate	Thermoduric Test Result cfu/mL	Adjustment to Base Rate
≤ 200,000	3%	≤80,000	0%	≤2,000	0%
201,000 - 300,000	0%	81,000 - 150,000	-5%	2,001 - 5,000	-5%
301,000 - 400,000	-10%	151,000 - 300,000	-20%	5,001 - 10,000	-20%
401,000 - 600,000	-20%	301,000 - 400,000	-30%	>10,000	-30%
>600,000	-30%	>400,000	-40%		

Volume Adjustment means the amount calculated in accordance with the table below.

Total Kg of milk fat and protein supplied in the month	\$/Kg of milk fat supplied in the month	\$/Kg of protein supplied in the month
Less than or equal to 22,999	0.44	0.66
Greater than or equal to 23,000	0.50	0.75

Tenure Adjustment means the amount calculated in accordance with the table below.

Continuous years of supply prior to the Commencement Date	\$/Kg of milk fat supplied in the month	\$/Kg of protein supplied in the month
1 & 2 years	0.04	0.06
3 & 4 years	0.07	0.11
5+ years	0.10	0.15

Proximity Adjustment means the adjustment applied on a CPL basis on the volume of milk supplied each month by suppliers in the regions set out in the table below which seek to account for the impact of a farm's distance to our nominated factory.

Region	CPL on all Milk supplied in the month
Central South Australia - from Two Wells (just north of Adelaide) to Meningie to Tintinara (including all of the Fleurieu))	3.00
South East South Australia (Mt Gambier region)	-1.00

Deductions

Deduction for Milk supplied outside Committed Monthly Volume

If, in any month, the volume of Milk that you supply to us is more than 10% above or below the Committed Monthly Volume for that month (the upper tolerance and lower tolerance, respectively) and we have not agreed with you in writing in accordance with clause 5(d)(ii) of Schedule D to that greater than 10% change in volume, we may adjust the Base Rate component of the Minimum Price for Milk that you supply us that month to account for the difference in volume in accordance with the table below.

	Deduction for July - January	Deduction for February - June
Volume above upper tolerance	5 CPL	0 CPL
Volume not supplied below lower tolerance	10 CPL	10 CPL

3.3 **Money we will reimburse to you**

We will reimburse you for costs that you incur in relation to:

- (a) servicing your milking machine(s);
- (b) servicing your vat(s);
- (c) vat replacement; and
- (d) herd recording,

in accordance with section 1.5 of the Handbook.

3.4 **Third-party charges**

You will be responsible for any third-party fees associated with:

- (a) compliance and quality assurance, such as auditor and testing fees as outlined in the Handbook; and

(b) additional freight charges as set out in section 4.1 of the Handbook.

We will pay for the reasonable costs associated with one audit every two years per farm by an auditor approved by us. We will directly pass through to you any additional fees charged by the third party by deducting those fees from your monthly milk payment.

SCHEDULE C - EXECUTION

Executed as an agreement.

Signed for and on behalf of **Lactalis Australia Pty Ltd ABN 56 072 928 879** by its duly authorised representative:

.....
Signature of authorised representative

.....
Name of authorised representative

.....
Position of authorised representative

.....
Date

Signed for and on behalf of the **Supplier** by its duly authorised representative:

.....
Signature of authorised representative

.....
Name of authorised representative

.....
Position of authorised representative

.....
Date

SCHEDULE D – STANDARD TERMS AND CONDITIONS

This MSA sets out the terms and conditions upon which you agree to supply Milk to us.

1. DEFINITIONS AND INTERPRETATION

1.1 Definitions

In this MSA:

ABN means Australian Business Number;

Approved Platform means Adobe Sign, AssureSign or a similar electronic signing platform;

Business Day means a day that is not a Saturday, Sunday or public holiday in Brisbane, Queensland;

Commencement Date means the commencement date specified in clause 1 of Schedule B;

Committed Monthly Volume means the volume of Milk you have nominated in Schedule B for each month of the Supply Period;

Complaint Handling Officer means our National Milk Supply Manager;

Confidential Information means all information belonging or relating to a party to this MSA, whether oral, graphic, written or in any other form, that is not generally available to the public at the time of disclosure other than by reason of a breach of this MSA or that is in fact, or should reasonably be regarded as, confidential to the party to whom it belongs or relates;

CPL means cents per litre of Milk;

Dairy Code means the *Competition and Consumer (Industry Codes – Dairy) Regulations 2019* (Cth);

End Date means the end date specified in clause 1 of Schedule B;

Farm means the property from which you will supply Milk to us and from where we will collect the Milk, having the address set out in Schedule A;

Force Majeure Event means any cause, matter or thing beyond the affected party's reasonable control, including, without limitation, strikes lockouts, labour disputes, acts of God or nature, acts of governments or their agencies, fire, flood, storm, riots, pandemic, power shortages or power failure, or disruption by war or sabotage;

GST Act means the *A New Tax System (Goods and Services Tax) Act 1999* (Cth);

Handbook means our Milk Supplier Handbook, a copy of which is contained in Schedule E;

Lactalis, us, we and **our** mean Lactalis Australia Pty Ltd ABN 56 072 928 879;

Mediation Adviser means the person appointed as mediation adviser under section 44 of the Dairy Code by the Minister for Agriculture, Drought and Emergency Management (Federal);

Milk means cow's milk produced at or for the Farm;

Minimum Price means the minimum price for Milk calculated in accordance with clause 3.2 of Schedule B;

MSA means this Milk Supply Agreement which is constituted by:

- (a) Schedule A – Details;

- (b) Schedule B – Key Terms;
- (c) Schedule C – Execution;
- (d) this Schedule D – Standard Terms and Conditions;
- (e) Schedule E – Handbook; and
- (f) Schedule F – Privacy Policy.

Privacy Policy means our privacy policy, a copy of which is contained in Schedule F;

Quality Requirements means the quality requirements for milk that fall within the specifications set out in column 3 titled “Specifications/Test Results” of the Quality Requirements table contained in section 2.6 of the Handbook;

Quantity Requirements means the requirement to supply the quantity of Milk set out in clause 8.1(b) of this Schedule D;

Senior Executive means the National Milk Supply Manager or a General Manager of Lactalis;

Supply Period has the meaning given to it by clause 1 of Schedule B;

You, you and your mean the party identified as the Supplier in Schedule A.

1.2 Interpretation

In this MSA:

- (a) words in the singular include the plural and vice versa;
- (b) if something is to be or may be done on a day that is not a Business Day then it must be done on the next Business Day;
- (c) the word "person" includes a natural person and anybody or entity whether incorporated or not;
- (d) the word "month" means calendar month and the word "year" means 12 months;
- (e) the words "in writing" include any communication sent by letter, or email or any other form of communication capable of being read by the recipient;
- (f) a reference to all or any part of a statute, rule, regulation or ordinance (statute) includes that statute as amended, consolidated, re-enacted or replaced from time to time;
- (g) wherever "include" or any form of that word is used, it must be construed as if it were followed by "(without being limited to)";
- (h) money amounts are stated in Australian currency unless otherwise specified; and
- (i) a reference to any agency or body, if that agency or body ceases to exist or is reconstituted, renamed or replaced or has its powers or functions removed (defunct body), means the agency or body which performs most closely the functions of the defunct body.

1.3 Order of precedence

- (a) To the extent of any conflict or inconsistency between the Schedules of this MSA, that conflict or inconsistency will be resolved in the following order of precedence (highest to lowest):
 - (i) the Key Terms in Schedule B;

- (ii) the Standard Terms and Conditions in this Schedule D;
- (iii) the Handbook in Schedule E;
- (iv) Schedule A and Schedule C; and
- (v) Schedule F.

1.4 Dairy Code

If the Dairy Code is inconsistent in any way with this MSA, that part of this MSA is severed and the rest of this MSA remains in force.

2. TERM

The MSA is effective for the duration of the Supply Period, unless terminated earlier in accordance with its terms.

3. COOLING OFF PERIOD

- (a) You may terminate this MSA with immediate effect without incurring any liability to us by giving us notice no later than 14 days after the day on which this MSA is entered into.
- (b) If this MSA is terminated during the cooling-off period, the terms of this MSA will apply to all Milk supplied by you to us up to and including the date on which the termination takes effect.

4. PURCHASING THE MILK

- (a) You agree to sell Milk to us, and we agree to buy Milk from you, for the Supply Period in accordance with the terms and conditions of this MSA.
- (b) For the avoidance of doubt, if this MSA is terminated before the end of the Supply Period, it will continue to apply to all Milk supplied by you to us up to and including the date on which the termination takes effect.

5. NON-EXCLUSIVE SUPPLY

- (a) You will supply us with Milk on a non-exclusive basis.
- (b) You agree to supply us the Committed Monthly Volume for each month of the Supply Period in equal weekly instalments.
- (c) We will purchase the Committed Monthly Volume (with a tolerance of up to and including 10% above or below the Committed Monthly Volume) from you for each month of the Supply Period.
- (d) Where you propose to supply us with a volume of Milk in any month that is more than 10% above or below the Committed Monthly Volume, then:
 - (i) at least 21 days prior to that month, you will provide us in writing the volume of Milk you will supply to us that month; and
 - (ii) we may agree with you in writing within 10 days after receipt of your notice under clause 5(d)(i) of this Schedule D, to accept that volume change.
- (e) If you have any additional Milk in excess of the Committed Monthly Volume then you can supply that excess milk to any third party or you can choose to offer it to us for supply to us in accordance with the terms of this MSA.

6. COMPLIANT OPERATION OF THE FARM

6.1 Compliance with laws etc.

- (a) You must operate the Farm in compliance with this MSA (which includes the Handbook), all applicable laws, regulations, codes of practice and good industry practice for:
 - (i) the production, storage and supply of milk;
 - (ii) animal health, welfare and husbandry;
 - (iii) environmental management and stewardship;
 - (iv) work health and safety; and
 - (v) milk quality.
- (b) You must ensure that all Milk that you supply to us complies with all applicable laws, regulations and codes of practice.

6.2 Costs of operation

You agree that you will, at your own cost, hold all necessary licences and approvals to operate the Farm and supply Milk to us.

7. QUALITY REQUIREMENTS

You must ensure that the Milk meets the Quality Requirements.

8. COLLECTION

8.1 Responsibilities regarding collection

- (a) We will collect the Milk from the Farm daily, or each alternate day, during the Supply Period.
- (b) At the time of each collection:
 - (i) you will ensure that at least 400 litres of Milk are available for collection and provide safe unrestricted access for us or our representative to collect the Milk in accordance with our instructions to you; and
 - (ii) that collection must include the entire volume of Milk in each vat or silo, unless otherwise agreed in writing between us.
- (c) You will notify us of any circumstances that may impact our ability to safely collect the Milk.
- (d) Collection of Milk does not indicate that we accept that the Milk meets our Quality Requirements.

8.2 Non-collection

- (a) We will not be obliged to collect Milk from the Farm in circumstances including:
 - (i) when it is not safe to do so due to:
 - (A) adverse weather conditions;
 - (B) road access issues, specifically a lack of adequate road access to the Farm;

- (C) government authorities restricting access to the Farm for public health or safety reasons or the tanker being unable to access the Farm for any other reason; or
- (ii) when the Milk is contaminated or unsuitable for collection.
- (b) We will not be liable to you for any loss suffered or incurred by you if and when we do not collect, or refuse to collect, Milk from the Farm in accordance with clause 8.2(a) of this Schedule D.

9. OWNERSHIP AND RISK

9.1 Ownership and risk

- (a) You warrant that you own the Milk free of any mortgage, charge or other security interest and that you have the right to supply the Milk to us.
- (b) Ownership of and risk in the Milk transfers to us once the Milk has passed tests on collection and the Milk is loaded into our, or our representative's, milk tanker at the Farm and the milk tanker has left the Farm. For clarity, ownership of and risk in the Milk, does not pass to us and remains with you if we do not collect, or refuse to collect, the Milk under clause 8.2 of this Schedule D.

10. SAMPLING PROCEDURE, TESTING AND VOLUME ACCURACY

- (a) We will take samples of the Milk in accordance with section 2.2 of the Handbook.
- (b) We will test, or arrange for the testing, of the samples of Milk in accordance with sections 2.4 and 2.6 of the Handbook.
- (c) We will give you written notice of the results of those tests, as soon as practicable after we test the Milk.
- (d) We will measure volume accuracy of the Milk you supply in accordance with section 2.3 of the Handbook.
- (e) We will provide you with written statements about the Milk in accordance section 2.18 of the Handbook.

11. QUALITY AND QUANTITY OF MILK

11.1 Notice of non-compliance with Quality Requirements

- (a) If you have reason to believe at any time during the Supply Period that the Milk does not meet our Quality Requirements, then you must notify us as soon as you have reason to be concerned.
- (b) On the first occasion in a year of the Supply Period that you notify us prior to collection that you do not believe that the Milk meets the Quality Requirements and we elect not to collect the Milk, we will pay you the Base Rate component of the Minimum Price for the volume of Milk we have elected not to collect.

11.2 Supply of contaminated Milk

- (a) If you supply Milk that is contaminated, then:
 - (i) we may not pay you for that Milk;
 - (ii) you may be held responsible for the total volume of milk (including any Milk) that we lose in the tanker or in our processing system where that milk has been contaminated by the contaminated Milk that you supply; and

- (iii) we may recover from you the costs of disposal of such contaminated milk and any other costs arising out of the contamination.

Contaminants may include antibiotics, blood, high microbial counts, and agricultural or veterinary chemicals.

11.3 **Rejection of Milk**

- (a) We may either reject your Milk (before or after collection) and/or suspend collection of your Milk if it does not meet any of the Quality Requirements or Quantity Requirements.
- (b) If we reject your Milk (before or after collection) and/or suspend collection of your Milk under clause 11.3(a) of this Schedule D, we will provide you, as soon as practicable, written notice of:
 - (i) the reasons for the rejection or suspension;
 - (ii) the consequences of the rejection or suspension and any associated costs for you to pay; and
 - (iii) any action plan we require you to implement to ensure continuous improvement and to avoid future rejections or suspensions.
- (c) We will not be liable to pay you for Milk that we have rejected or refused to collect in accordance with this MSA.

11.4 **Other acts of non-compliance**

- (a) If you do not comply with any other terms of this MSA (other than in relation to the Quality Requirements and the Quantity Requirements) then you must inform us as soon as practicable after you become aware of the non-compliance.
- (b) For all acts of non-compliance of which you inform us under clause 11.4(a) of this Schedule D or of which we become aware (excluding any acts of non-compliance in relation to the Quality Requirements and Quantity Requirements) we may:
 - (i) provide you with notice to remedy the non-compliance within a reasonable time frame; and
 - (ii) suspend collecting Milk from the Farm until such time as we are satisfied that you have remedied the non-compliance.

12. **HERD SIZE**

You must provide us with at least 30 days' written notice of any proposed change in the size of your milking herd of more than 10%.

13. **PAYMENTS**

13.1 **Price**

We will pay you the Minimum Price for Milk that you supply to us each month.

13.2 **Payment for supply**

We will pay you by electronic funds transfer to your nominated bank account (as verified by Lactalis) on the 15th day of the month following the month of supply. If the 15th day falls on a weekend or public holiday, payment will be made on the Business Day before the 15th.

14. AUDITS

14.1 Right to audit

Upon reasonable notice, we (or an independent third party that we appoint) may access and review any records and farm practices and procedures to determine whether you are complying with this MSA.

14.2 Non-compliance

If you are found not to be complying with this MSA, then we will provide you with notice in accordance with clause 14.1 of this Schedule D and provide you with reasonable opportunity to remedy the concerns.

14.3 Audit costs

Costs of audits will be determined in accordance with section 2.20 of the Handbook.

15. GST

15.1 Definitions

In this MSA the expressions “consideration”, “GST”, “input tax credit”, “supplier”, “supply”, “tax invoice”, “recipient”, “recipient created tax invoice” and “taxable supply” have the meanings given to those expressions in the GST Act.

15.2 No GST

Unless otherwise set out, the parties confirm that any amount payable under this MSA is calculated without regard to GST.

15.3 Pay GST

If any goods or services supplied are taxable supplies, then on payment of any amount under this MSA, a party must also pay the other party any applicable GST.

15.4 Assisting in claiming GST

Each party must do everything reasonably necessary to assist the other to claim a GST input tax credit.

15.5 ABN

You must be registered for GST and must maintain the registration of your ABN throughout the Supply Period.

15.6 Recipient created tax invoices

The parties agree that a separate recipient created tax invoice agreement shall be entered into between them. The parties agree that the supplier will not issue tax invoices and instead, the recipient shall issue recipient created tax invoices in line with the recipient created tax invoice agreement.

16. INDEMNITY

You indemnify us against any claims by third parties for death or injury to any person or loss or damage to any property caused by your negligence or breach of this MSA, except to the extent that we have contributed to the death, injury, loss or damage.

17. **FORCE MAJEURE**

17.1 **Force Majeure Event**

- (a) Where we are unable to collect Milk which is to be supplied to us due to a Force Majeure Event, risk in and ownership of the Milk remains with you and we have no obligation to pay for the supply of that Milk.
- (b) If a Force Majeure Event prevents us from collecting Milk which would otherwise be supplied to us, you may, for the term of the Force Majeure Event, supply your Milk to any other party.

18. **RECORDS**

The parties must keep originals or copies of this MSA and any notice or statement issued under this MSA or the Dairy Code, including notices of variation and termination for a period of six years after the End Date.

19. **RESOLVING DISPUTES**

19.1 **Complaint handling procedure**

If either party has a complaint about or in connection with this MSA (**Complaint**) then that Complaint must be dealt with in accordance with clauses 19.2 to 19.5 of this Schedule D or, if that fails, by mediation in accordance with clauses 19.6 to 19.12 of this Schedule D.

19.2 **Notice details**

If you are the complainant then you must provide written notice of the Complaint to our Complaint Handling Officer. If we are the complainant we will provide you written notice. The notice of complaint (**Complaint Notice**) must provide details of:

- (a) the nature of the Complaint;
- (b) that the complainant wants the Complaint to be dealt with in accordance with this complaint handling procedure; and
- (c) the outcomes that the complainant requires.

19.3 **Response**

The party receiving the Complaint Notice (**respondent**) must, within five Business Days after receiving the Complaint Notice, give a written acknowledgement (**Acknowledgement**) to the complainant stating:

- (a) the Complaint Notice has been received; and
- (b) the steps to be taken to resolve the Complaint.

19.4 **Procedure**

- (a) Within 14 days after receipt of a Complaint Notice, the complainant and the respondent must meet to attempt to resolve the Complaint.
- (b) If, within 28 days of receipt of a Complaint Notice, the Complaint remains unresolved, the Complaint must be referred, at the request of either party, to a Senior Executive of ours (or their nominee) to meet with the complainant and the respondent to attempt to resolve the Complaint.
- (c) The complainant may at any time withdraw the Complaint by notice in writing to the respondent.

19.5 **Unresolved Complaint**

If, within 60 days after the Acknowledgement was given to the complainant, the Complaint remains unresolved, then either party may take action to have the Complaint resolved by mediation in accordance with clauses 19.6 to 19.12 of this Schedule D.

19.6 **Mediation**

- (a) The parties must request that the Mediation Adviser appoint a mediator for the dispute.
- (b) The Mediation Adviser:
 - (i) must appoint a mediator within 14 days after receiving the request under clause 19.6(a) of this Schedule D unless the Mediation Adviser is satisfied that the Complaint giving rise to the dispute:
 - (A) is frivolous or vexatious; or
 - (B) has previously been the subject of another mediation; and
 - (ii) must give the parties to the dispute, in writing, details of the mediator appointed.

19.7 **Conduct of mediation**

- (a) Subject to clause 19.7(b) of this Schedule D, the mediator must decide:
 - (i) how the mediation is to be conducted (for example, by telephone or in meetings);
 - (ii) the time and place for the mediation; and
 - (iii) the day the mediation commences for the purposes of this MSA.
- (b) The mediation must be conducted in Australia.

19.8 **Notice of commencement of mediation**

Within 14 days after the mediation has commenced, the mediator must notify the Mediation Adviser, in writing, that the mediation has commenced and of the nature of the dispute.

19.9 **Attendance at mediation**

- (a) Each party to the dispute must attend the mediation and attempt to resolve the dispute.
- (b) For the purposes of clause 19.9(a) of this Schedule D, a party is taken to attend a mediation to attempt to resolve a dispute if the party is represented at the mediation by a person who has authority to enter into an agreement to settle the dispute on behalf of the party.

19.10 **Notice of successful mediation**

If an agreement is reached in relation to the dispute, the mediator must, within 14 days after the agreement is reached:

- (a) set out, in writing, the terms of the agreement;
- (b) give a copy of the terms to each party to the dispute; and
- (c) notify the Mediation Adviser that an agreement has been reached.

The party who requested the mediation may, at any time, withdraw the Complaint that is the subject of the dispute by notice in writing to the other party to the dispute and the mediator.

19.11 Termination of mediation

- (a) The mediator conducting a mediation of a dispute in accordance with this MSA:
 - (i) may terminate the mediation at any time if the mediator is satisfied that a resolution of the dispute is not likely to occur; and
 - (ii) must terminate the mediation if the party who requested the mediation requests the mediator to do so.
- (b) If a dispute that is the subject of mediation in accordance with this MSA is not resolved within 30 days after the mediation commenced:
 - (i) the respondent to the mediation may ask the mediator to terminate the mediation; and
 - (ii) the mediator must do so.
- (c) If the mediator terminates a mediation under clause 19.11(a) or (b) of this Schedule D, the mediator must issue a certificate stating:
 - (i) the names of the parties to the mediation;
 - (ii) the nature of the dispute that was the subject of the mediation;
 - (iii) that the mediation has been terminated; and
 - (iv) that the dispute has not been resolved.
- (d) The mediator must give a copy of the certificate to:
 - (i) the Mediation Adviser; and
 - (ii) each party to the dispute.

19.12 Costs of mediation

- (a) Each party to a dispute that was the subject of a mediation must pay half the costs (if any) of the mediation (being all reasonable costs associated with the conduct of the mediation), unless the parties to the mediation agree otherwise.
- (b) Each party to a dispute that was the subject of a mediation must pay that party's costs of attending the mediation, unless the parties agree otherwise.

19.13 Court proceedings

The parties must comply with this clause 19 before commencing court proceedings in relation to a Complaint or a dispute between the parties in relation to or arising under this MSA, except proceedings for urgent interlocutory or final relief. If a dispute is not resolved by mediation then, either party may, if it wishes, commence court proceedings.

19.14 Interlocutory relief

Neither party is prevented from seeking an urgent injunction in relation to this MSA.

19.15 Ongoing obligations

Despite the existence of a Complaint or dispute between the parties arising out of or in relation to this MSA, each party must continue to comply with its obligations under this MSA.

20. TERMINATION

20.1 Grounds for immediate unilateral termination by you

You may immediately terminate this MSA by notice in writing to us, if we commit a material breach of this MSA.

20.2 Grounds for immediate unilateral termination by us

- (a) We may immediately terminate this MSA by notice in writing to you, if you commit a material breach of this MSA, which includes:
 - (i) a material breach of this MSA which is not remedied within 30 days after receiving written notice from us requiring you to do so;
 - (ii) a material breach of the Quality Requirements;
 - (iii) a material breach of the Quantity Requirements;
 - (iv) a material breach of the following sections of the Handbook:
 - (A) 3.1 – Work Health and Safety;
 - (B) 3.2 – Social and Ethical Policy;
 - (C) 3.6 – Environment;
 - (D) 3.7 – Animal Health;
 - (E) 3.8 – Animal Welfare; and
 - (v) a material breach of applicable State or Federal legislation.

20.3 Process for termination

- (a) If a party terminates this MSA under clause 20.1 or 20.2, then that party will provide the other party, as soon as practicable, with written notice of:
 - (i) the termination;
 - (ii) the reasons for the termination; and
 - (iii) the day the termination takes effect.

20.4 Mutual termination

The parties may terminate this MSA by written mutual consent. We will not unreasonably withhold our consent.

20.5 No loss of rights

Termination or expiry of this MSA will not prejudice any right of action or remedy which may have accrued to either party.

21. GENERAL

21.1 Nature of obligations

- (a) Any provision in this MSA which binds more than one person binds all of those persons jointly and each of them severally.
- (b) Each obligation imposed on a party by this MSA in favour of another is a separate obligation.

21.2 Entire terms and conditions

This MSA contains the entire agreement between the parties for your supply of Milk to us. Any other prior understandings, representations, warranties or undertakings of any kind made by or on behalf of either party in relation to the subject matter of this MSA are of no effect.

21.3 No waiver

A party's failure to or delay in exercising a right under this MSA does not operate as a waiver of that right. A waiver is not effective unless it is in writing.

21.4 Severability

If any provision of this MSA is unenforceable, illegal or void or makes the MSA (or part of it) illegal or void, then the provision is severed and the rest of this MSA remains in force.

21.5 No assignment

- (a) You cannot assign or otherwise transfer the benefit of this MSA, or ownership of the Farm without our prior written approval (which cannot be unreasonably withheld).
- (b) If we agree to you assigning or transferring the benefit of this MSA or the Farm to a third party, we may require you to novate this MSA to the assignee and/or purchaser from the date of transfer.

21.6 Costs

Each party must pay its own legal costs of and incidental to the preparation and completion of this MSA.

21.7 Governing law and jurisdiction

This MSA is governed by and must be construed in accordance with the laws in force in the State in which the Farm is operated.

21.8 No agency, joint venture or partnership

It is understood and agreed that the only relationship between the parties is that of independent contractors and that no agency, joint venture, employment relationship or partnership is created by the parties.

21.9 Variation

(a) Mutual variation

This MSA may only be varied by the parties agreeing in writing to such variation, subject to clause 21.9(b) of this Schedule D. No variation can be made if it would contravene the Dairy Code.

(b) Variation by us

We may unilaterally vary this MSA where there is a change in a Commonwealth, State or Territory law:

- (i) to the extent necessary to comply with the changed law; and
- (ii) without reducing the Minimum Price.

If we unilaterally vary this MSA, we will provide you, as soon as practicable, with written notice of:

- (i) the variation;

- (ii) the reasons for the variation; and
- (iii) the day the variation takes effect.

(c) **Variation which increases Minimum Price**

An increase in the Minimum Price payable to you constitutes a variation to this MSA and the Dairy Code requires that you agree to the payment of the increase. We will notify you of the increase in the Minimum Price and at the same time advise you how you can agree to that price increase and, if you do not agree in the manner and in the time set out in our notice, then you shall be deemed to have accepted that increase in the Minimum Price.

(d) **Variation by you**

You are unable to unilaterally vary this MSA.

21.10 Confidentiality

If either party provides the other party (**Receiving Party**) with Confidential Information then the Receiving Party must not disclose that Confidential Information unless it is:

- (a) to obtain legal, financial or other business advice;
- (b) already publicly known;
- (c) required by law, regulation or direction of an authority to be disclosed;

You must not disclose the terms of this MSA or Confidential Information (including commercial information) relating to this MSA without our prior written consent.

21.11 Privacy

We will hold your personal information in accordance with the Privacy Policy.

21.12 Notices

- (a) Any notice or other communication required to be given under or in connection with this MSA can be delivered by addressing that notice to the other party at its address set out in Schedule A of this MSA and serving the notice at that address.
- (b) Notice may be delivered by hand, post or by email with service deemed to have occurred as follows:

Delivery Method	Notice Given
Hand	If before 4pm local time in the place of delivery, the notice will be taken to be delivered the day of delivery.
Post	5 th Business Day in the place of delivery after the notice is posted
Email	A notice may be sent in electronic form and will be deemed given and received on the first day on which it could have been read by the addressee. But if the notice is received after 5pm on a Business Day, or a day that is not a Business Day, then the notice is taken to have been received on the next Business Day.

21.13 Trustees

- (a) Unless you have told us that you are the trustee of a trust, you warrant that you are entering into this MSA in your own capacity.
- (b) If you have told us you are entering into the MSA as a trustee, you are entering into this MSA on your own behalf and on behalf of the trust and you warrant to us that you:
 - (i) have entered this MSA for the trust's benefit and purpose and have arranged any required approvals for the trust's property to be bound to this MSA;
 - (ii) have the power under the trust deed to enter into this MSA, to fulfil your obligations under this MSA, and to use the assets of the trust to pay any amount required in connection with this MSA; and
 - (iii) acknowledge and agree that we are entering into this MSA on the basis that each of the warranties in this clause 21.13 of this Schedule D are true and correct and will remain true and correct throughout the term of this MSA.

21.14 Modern slavery

- (a) In this clause, **Anti-Slavery Laws** means:
 - (i) Divisions 270 and 271 of the *Criminal Code Act 1995* (Cth);
 - (ii) the *Modern Slavery Act 2018* (Cth); and
 - (iii) any other applicable law which prohibits exploitation of a worker, human trafficking, slavery, slavery-like behaviour, servitude, forced labour, child labour, debt bondage or deceptive recruiting for labour or services (or similar), and is applicable in the jurisdiction in which you and we are registered or conduct business or in which activities relevant to the supply of the Milk are to be performed.
- (b) You warrant to us that, to the best of your knowledge, you and your employees, officers and representatives do not engage in any conduct or omission which contravenes the Anti-Slavery Laws and you are not aware of any risks present in your operations and supply chains that may contravene the Anti-Slavery Laws or, if you are so aware, you have taken appropriate action to mitigate, remediate and reduce those risks (including providing notice to us under clause 21.14(d)(i) of this Schedule D).
- (c) You must ensure that, in performing your obligations in connection with the supply of Milk, you and your officers, employees and representatives:
 - (i) do not engage in any conduct or omission which may contravene any Anti-Slavery Laws;
 - (ii) comply with any policy of ours relating to anti-slavery; and
 - (iii) do all things required or necessary to mitigate or reduce modern slavery risks in your operations and supply chains and stay in compliance with all applicable Anti-Slavery Laws.
- (d) You must:
 - (i) promptly notify us if you become aware of a possible, potential, suspected or actual breach by you or your employees, officers or representatives of any Anti-Slavery Laws;
 - (ii) cooperate in good faith with us in investigating the circumstances relevant to any possible, potential, suspected or actual breach of any Anti-Slavery Laws,

whether or not notification has been given under clause 21.14(d)(i) of this Schedule D;

- (iii) provide such assistance and information as we reasonably require in respect of this MSA and the supply of Milk in order to prepare, as required, a modern slavery statement each financial year and to comply with the Anti-Slavery Laws; and
- (iv) establish and maintain policies and procedures to ensure that you and your employees, officers and representatives comply with the obligations set out in this clause.

21.15 Execution

- (a) This MSA may be executed in any number of counterparts, each executed by one or more parties.
- (b) This MSA may be executed electronically by any party, or all parties, using an Approved Platform or by returning a fully signed copy of this MSA to us at the address set out in Schedule A by way of registered mail. Any electronic copy of this document so signed will constitute an executed original counterpart. Any hard copy of this document so signed and returned to us will constitute an executed original counterpart.
- (c) All counterparts together will be taken to constitute one MSA.
- (d) This MSA will be deemed to have been validly entered into and will be final and binding once all parties have signed even if one or more parties sign electronically using an Approved Platform.
- (e) Each party who signs this MSA using the Approved Platform is bound by, has complied with and will comply with any terms and conditions of the Approved Platform, in relation to the execution of this document.
- (f) This clause 21.15 does not limit the ways in which a party may execute this document.

SCHEDULE E – HANDBOOK



MILK SUPPLIER HANDBOOK

National Edition 3

1 July 2022 - 30 June 2023

TABLE OF CONTENTS

Lactalis Australia's Vision.....	3
About Lactalis.....	4
Our Brands.....	7
1. General Information.....	9
1.1 Abbreviations.....	9
1.2 Purpose.....	9
1.3 Minimum Collection Requirement.....	9
1.4 Payment for Supply.....	10
1.5 Supplier Reimbursements.....	10
2. Milk Quality Requirements.....	12
2.1 Milk Quality.....	12
2.2 Sampling Procedure.....	12
2.3 Volume Measurement.....	12
2.4 Testing Procedure.....	13
2.5 General Quality Requirements.....	13
2.6 Milk Quality Requirements.....	13
2.7 Application of Quality Requirement Adjustments Explained.....	17
2.8 Milk Temperature.....	18
2.9 Age of Milk.....	19
2.10 Bactoscan (Bacto).....	19
2.11 Thermoduric (Thermo).....	19
2.12 Bulk Milk Cell Count (BMCC).....	19
2.13 Antibiotics (Inhibitory Substances).....	20
2.14 Extraneous Water/Freezing Point.....	20
2.15 Acidity and pH.....	21
2.16 Sediment.....	21
2.17 Chemical Standards and General Milk Quality Standards.....	21
2.18 Testing Results.....	23
2.19 Payment for Milk Not Collected when Notified of Potential Issues.....	23
2.20 External Auditing.....	23
3. Our Agreed Responsibilities.....	26
3.1 Work Health and Safety.....	26
3.2 Social and Ethical Policy.....	26
3.3 Whistleblower Policy.....	27
3.4 Corporate Image.....	27
3.5 Farm Presentation.....	27
3.6 Environment.....	27
3.7 Animal Health.....	27
3.8 Animal Welfare.....	28
4. Transport.....	31
4.1 Farm to Factory Transport and Collection Requirements.....	31
Contacts.....	34

Lactalis Australia's Vision

TO HAVE EVERY DAY CONSUMERS RECOGNISE LACTALIS AS THEIR FIRST CHOICE PROVIDER OF TASTY AND NUTRITIOUS DAIRY PRODUCTS AND BEVERAGES

About Lactalis

Company History in Australia

We are a national dairy company with a long and proud history in Australia, a history that commenced with the opening of the Pauls milk factory on the banks of the Brisbane River back in the 1930s. More than 80 years on, we are now part of a global dairy organisation that brings nutrition and wellness to people all over the world. We have great brands and great people. We continue to invest and expand in Australia, setting the benchmark for the dairy industry locally and playing an ever-increasing role in the export of dairy products into Asia.

Lactalis Australia and Lactalis Group

Lactalis Australia is owned and operated by the Lactalis Group. A third generation, French family owned business, Lactalis Group is the world's largest fresh dairy company with over 250 production sites and 80,000 employees across 94 countries.

Lactalis Australia benefits from the multi-national scale and ambition of its parent company, without sacrificing any of the proud local heritage and traditions that began with the original Pauls milk business in 1932.

At the heart of business locally, we have more than 2300 passionate employees, working closely and constructively with some 500 Australian farmers to produce the finest dairy goods in the country.











DARWIN
 • White & Flavoured Milk

HARVEY
 • White & Flavoured Milk
 • UHT Milk
 • Yoghurt and Desserts
 • Creams
 • Juice

CLARENCE GARDENS
 • White & Flavoured Milk
 • ESL Milk
 • Yoghurt and Desserts

LACTALIS AUSTRALIA

LEGEND OF DAIRY FARMING AREAS BY REGIONAL DEVELOPMENT PROGRAM

 Dairy Industry Development Company	 Murray Dairy
 DairySA	 Subtropical Dairy
 DairyTas	 WestVic Dairy
 GippsDairy	 Western Dairy

 Lactalis Site

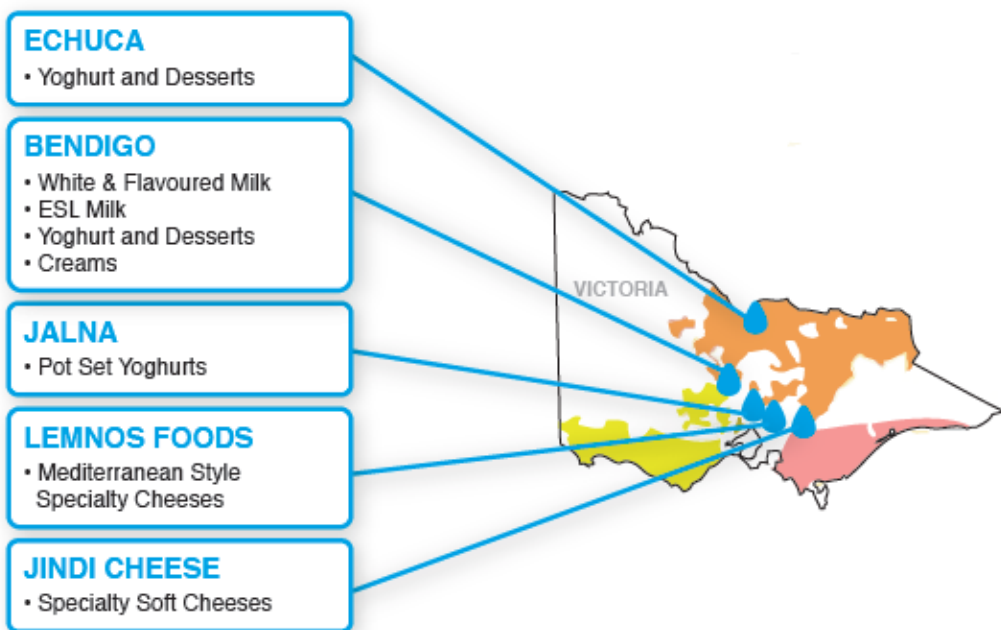
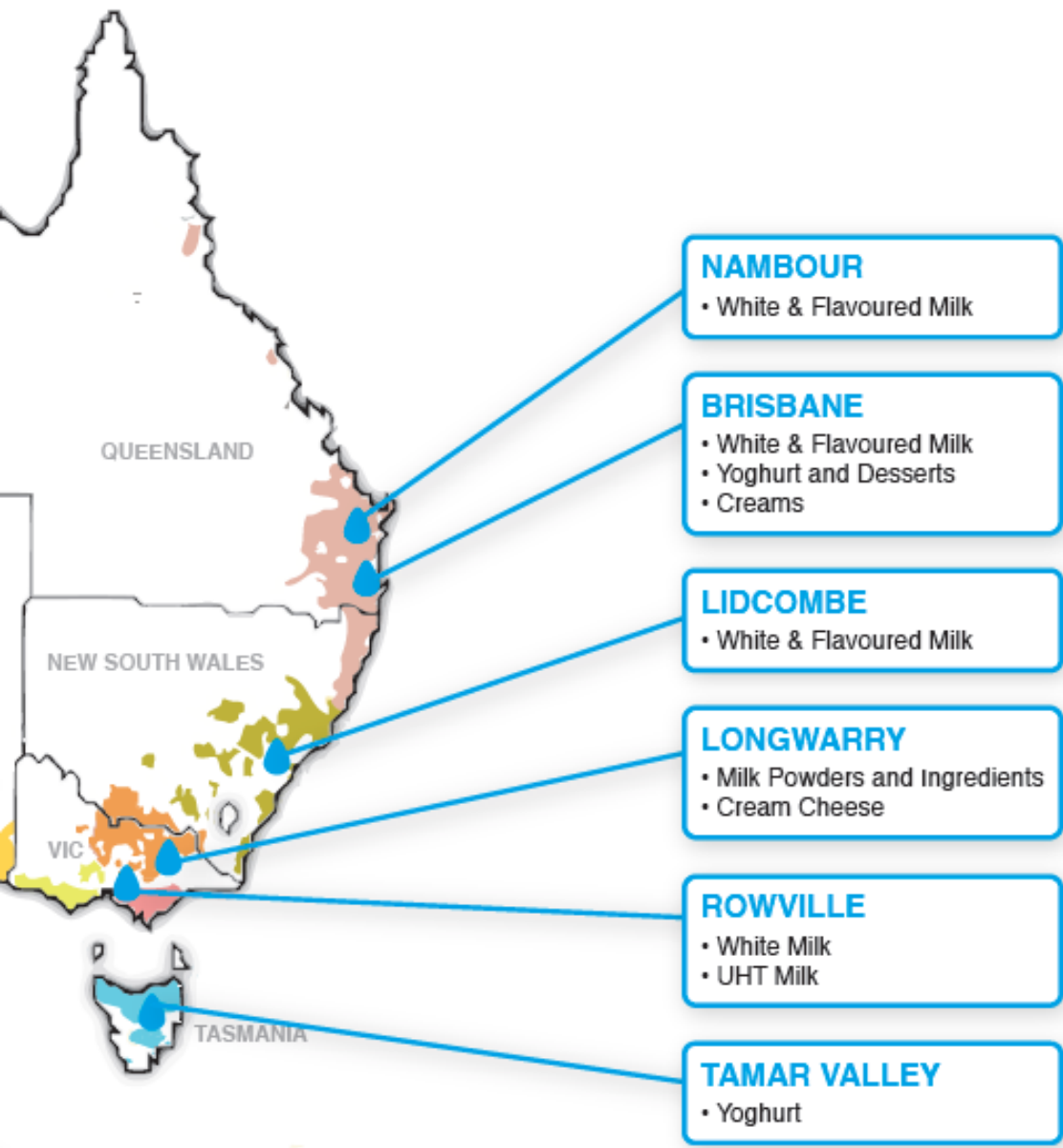

Our Brands

Pauls Milk, Jalna, Kraft, Ice Break Iced Coffee, Tamar Valley and Vaalia yoghurt, Oak and Breaka flavoured milk are leading examples of Lactalis Australia products which over the years have become synonymous with high quality and Australian community values.



PAULS

Pauls is Extraordinary Dairy. Catering for your whole family's needs with a nutritious range of milk, custard, yoghurt and creams. Pauls, a family tradition for more than 75 years.



VAALIA

With a special combination of live and active probiotic cultures, Vaalia is deliciously creamy yoghurt that makes you feel good.



TAMAR VALLEY

There's nowhere on earth like the rolling hills of the pristine Tamar Valley in Tasmania. We think it's the perfect place to create our range of thick and creamy yoghurts. Tasmanian Tamar Valley Dairy tastes delicious because we make it in Tasmania from locally sourced fresh milk. But don't take our word for it, taste the Tassie goodness in Tasmanian Tamar Valley Dairy for yourself.



LEMNOS

Lemnos offers a range of delicious and authentic Mediterranean style cheeses.

Representing the No. 1 Haloumi brand in Australia and an extensive range of quality Fetta cheeses, Lemnos crafts cheeses to traditional recipes so you can share a little bit of the Mediterranean. Celebrate life the Mediterranean way!



ICE BREAK

Perfect to get your day going and keep you pumping, nothing satisfies quite like and ice cold Ice Break. With heaps of pack sizes available, Ice Break is ready for anything and everything.

Bring It On!



PRÉSIDENT

Président® is one of the world's premier cheesemakers and the number one brand of cheese in France.

Through over 75 years of French tradition and expertise, Président has become the hallmark of taste and quality.



OAK

Oak really hits the spot when you're hungrythirsty. An Australian favourite for more than 40 years with its wide range of rich, creamy and authentic flavours - OAK is always the answer. Full flavour, full strength, full on.



GALBANI

130 years of inspiration from Galbani, the No. 1 cheese brand in Italy!

With Galbani fresh mozzarella and bocconcini, your family can enjoy the deliciously fresh, authentic taste of Italian style cheese made right here in Australia.

1. General Information

1.1 Abbreviations

Within this document the following abbreviations/definitions are used.

ABBREVIATION	FULL NAME
ADF	Australian Dairy Farmers
Agreement	Milk Supply Agreement
AMRA	Australian Milk Residue Analysis
Bacto	Bactoscan
BMCC	Bulk Milk Cell Count
bST/BGH/rbST	bovine Somatotropin/Bovine Growth Hormone/recombinant bovine Somatotropin
CAR	Corrective Action Request
EBL	Enzootic Bovine Leucosis
GE / GM	Genetically Engineered / Genetically Modified
GMO	Genetically Modified Organism
GST	Goods and Services Tax
Handbook	Milk Supplier Handbook
IBC	Individual Bacteria Count
ICCC	Individual Cow Cell Count
Lactalis	Lactalis Australia Pty Ltd
MRL	Maximum Residue Limit
Q&Q Statements	Quality and Quantity Statements
SCC	Somatic Cell Count
Thermo	Thermoduric Plate Count

1.2 Purpose

This Handbook provides requirements for and information relating to:

- a. quality and quantity of milk supplied,
- b. milk collection,
- c. sampling procedures
- d. volume accuracy assurances,
- e. testing of the milk and
- f. statements that we provide to you about the milk.

1.3 Minimum Collection Requirement

At the time of each collection, you must supply at least 400 litres of milk for collection. The collection

must also include the entire volume of milk in each vat or silo, unless otherwise agreed in writing between us.

If you are likely to be impacted by this requirement then please let us know and we will work with you to ensure that you are fully in a position to make appropriate decisions for your business.

It is your responsibility to ensure you have sufficient vat capacity to allow for a maximum of once per day collection.

Milk must be refrigerated, agitated and less than 48 hours old from harvesting.

1.4 Payment for Supply

General

You will be paid for milk supplied in accordance with the prices and methods set out in the Agreement. Payment will be made on the 15th day of the month following the month of supply. However, if the 15th falls on a weekend or public holiday, payment will be made on the business day prior to the 15th.

All payments will be made to your nominated bank account, as verified by us. We will send payment statements by email.

Share Farm or Lessee Payments

We have an agreement with you. If you share-farm or lease part of your farm, then it is up to you to determine whether a percentage payment is to be made to a share-farmer or lessee. If this is the case then please provide us in writing with details of such payments.

1.5 Supplier Reimbursements

Reimbursements for servicing your Milking Machine and Vat

You may request reimbursement of the cost of one milking machine service and one vat service each Supply Period, to a maximum value of \$3000 per service per farm. We will only reimburse you the costs associated with labour and travel for each service (excluding GST only). Parts and labour for repairs and upgrades are not eligible for reimbursement.

You are to pay for the service and then provide us with a copy of the itemised invoice no later than three months from the date of the service in order to be eligible for reimbursement.

Reimbursement for replacing your vat

We will reimburse you one third of 20% of the costs associated with upgrading your milk cooling capability with the purchase and installation of a new or second-hand milk vat, for each year that you contract with us up to a maximum of three years.

The 20% is calculated on the cost of the vat and associated cooling equipment, including installation costs (excluding GST).

To be eligible for this assistance, the following criteria must be met:

- a. All vats must have a 75 mm outlet, or an equivalent adaptor;
- b. Vat capacity must be increased to at least 1.4 times peak daily production;
- c. The above-mentioned vat capacity must be achieved with no more than two vats being installed and in use on the farm;
- d. The vat must be positioned so that the outlet is no more than six metres from the tanker connection and no more than three metres from the tanker access doorway.

Where all of the above criteria are met, you should contact your Supplier Relationship Manager to calculate the reimbursement amount.

Reimbursement for herd testing and recording

We will reimburse you \$3.50 per cow each year of the Agreement that you complete herd testing and recording.

Regular herd testing and recording provides you with valuable information about your individual cow

cell counts and will help to:

- a. identify individual cows that may be causing the Bulk Milk Cell Count to rise;
- b. track new infection rates during key times of the year;
- c. make decisions about the drying-off treatment strategy;
- d. make decisions about culling.

Herd testing also provides information on milk yields to aid in drying-off decisions in late lactation.

We encourage you to conduct herd testing and to use the results in farm management decisions. The data from herd recording is also used by the wider industry for sire progeny testing.

You are eligible for this reimbursement if you meet the following requirements:

- a. By 31 July of the current Agreement year, you must submit to us the previous agreement year's (1 July – 30 June) annual statement for herd testing costs. You must use a recognised herd recording centre to carry out the testing, and the statement must show the number of cows tested and the total testing costs.

Reimbursement will be made with the monthly milk payment for July (i.e. on or about 15 August).

2. Milk Quality Requirements

2.1 Milk Quality

We set out in this section our sampling and testing procedures and other matters relevant to assessing whether your milk meets our quality requirements, as set out in section 2.6 and the table below.

2.2 Sampling Procedure

Milk samples for composition and cell count testing are taken automatically at every collection by either an inline drip sampler which is fitted to the tanker or a dip method directly from the vat. These sampling methods are designed to ensure a representative sample of the milk is taken from the collection.

Before pumping into the tanker, the driver will agitate the vat to ensure an adequate distribution of components throughout the milk.

Drip Sample Collection - During Loading

These samples are collected from a hygienic sampling device which is fitted to the tanker, and collects small quantities of milk during loading.

All sample bottles are labelled to identify the collection, Supplier and analysis requirements.

Samples are aseptically collected in a sterile sample bottle, which is sealed and stored, on ice or under refrigerated conditions until analysis is completed.

Directly From the Vat DIP Method

In the case where a drip sample is not possible, or may not be sufficiently filled, where possible, a manual dip sample must be taken.

All sampling equipment is sterilised using a 250ppm chloride solution or 70% alcohol solution.

Australian Milk Residue Survey

Australian Milk Residue Survey is a national independent monitoring program for potential agricultural and veterinary chemical residues and environmental contaminants in Australian bovine milk.

We are required to collect milk samples as part of our participation in the AMRA Survey. Raw milk samples are taken randomly from all dairy regions and submitted to independent testing laboratories for analysis. When a residue is detected in a sample, we, the relevant state regulatory authority, and the Department of Agriculture are notified.

Follow-up action is required for milk samples identified at or above the set action levels. For more information on the AMRA Survey: <https://www.dairyaustralia.com.au/industry/food-safety-and-regulation/regulatory-framework/australianmilk-residue-analysis-survey>

2.3 Volume Measurement

To assure volume accuracy, the volume of each collection will be measured for payment purposes by a calibrated flow meter fitted to the milk collection tanker. We require that the carrier collecting the milk, meets and conforms to all relevant regulatory requirements and uses and maintains all volume and temperature recording equipment according to all national measurements legislations and trade measurement regulations.

We require any flow meter installed on a milk collection vehicle to be maintained in good working order and be calibrated on a 6 monthly basis. All temperature sensing equipment fitted to a milk collection vehicle must be calibrated on a 6 monthly basis.

2.4 Testing Procedure

Point of Collection

Prior to collection, the driver assesses the time and temperature cooling profile and completes a sensory evaluation (odour and visual appearance) for potential contamination, food safety risk, and milk quality deterioration. From time to time we may require more specific testing to be completed.

Point of Delivery

When the milk is delivered, it is tested by the receiving site for contaminants and milk quality. If it does not meet these standards, individual farm samples are tested to detect the source of the contamination or defective milk collection, for example antimicrobial substance residue.

An independent external milk testing service provider tests all collection samples for components, somatic cell content, bacteriological content and residues and conducts a range of other tests as required. These results are then reported to us at the same time.

Milk composition (fat and protein) is measured on a mass volume basis.

Payment for Additional Testing

If you request for us to organise additional testing then we will directly pass through third party costs to you by deducting them from the monthly milk payment. We will obtain your confirmation of any third party costs associated with additional tests prior to proceeding with that testing.

2.5 General Quality Requirements

In calculating the minimum price for milk under the Agreement, adjustments will be applied to the base rates for each collection of milk to reflect the level of compliance with the Quality Requirement specifications as set out in the table in section 2.6 below. The adjustments per collection will be shown on your monthly milk statement.

Any adverse or non-compliant test result could result in us auditing your compliance with the Agreement.

Any failure to meet Quality Requirements imposed under this Handbook which results in the contamination of other milk in the tanker or in the processing system, may render you liable for the total volume of milk lost, including costs for additional testing, segregation, extra transport, processing/disposal of the contaminated milk and other costs arising out of the contamination. Such contaminants may include, but are not limited to:

- a. Antibiotics;
- b. Blood;
- c. High microbial counts to such a level that the tanker load is rejected by the receiving factory;
- d. Agricultural or veterinary chemicals.

In these circumstances, we are also not required to pay you for the milk.

2.6 Milk Quality Requirements

You are required to supply Milk to us in the following way:

- a. Milk will be tested by us at the times set out in column 2 of the Quality Requirements Table;
- b. Milk falls within the specifications in column 3 of the Quality Requirements Table;
- c. If the Milk meets the specifications in column 3 then we may still accept your milk, but we will make a percentage adjustment to the base rate component of the minimum price that we pay you for your milk;
- d. The amount of the adjustment will be calculated in accordance with column 4 of the table below. Any deduction to the base rate component of the minimum price will not be more than 50% per collection.

We may also reject or suspend collection of your Milk in accordance with clause 11 of the Agreement.

We also have a right to audit, upon reasonable notice for compliance to the Agreement.

Quality Requirements Table

	TEST FREQUENCY	SPECIFICATIONS/ TEST RESULTS	PERCENTAGE ADJUSTMENT(+/-)
SENSORY ASSESSMENT	Every collection of milk, prior to loading by the tanker driver	Fresh clean smell. No unpleasant characteristics, including clean white appearance, no odours, no chemical residue or foreign matters	0%
TEMPERATURE	Every collection of milk	≤5°C	0%
		>5°C – no prior notification of cooling failure	0% Milk may be rejected
		>5°C – prior notification of cooling failure	0% If milk is deemed unsuitable for collection, it may still be paid for at base rate in accordance with clause 11.1(b) of the Agreement,
ANTIBIOTICS	When antibiotics are detected on a tanker of milk ex-farm, each Supplier on that tanker will have their vat sample tested	Antibiotics present in milk tanker with NO PRIOR NOTIFICATION of possible or probable residues in milk	-100% + costs Refer to clause 11.2 of the Agreement. We will not pay you for that collection of Milk and you may be held responsible for the total volume of milk lost and recover the cost of disposal of the milk and other costs arising out of the contamination
		Antibiotics present in farm vat with PRIOR NOTIFICATION of possible or probable residues in milk (i.e. milk not collected)	0% for first incident in an Agreement year (milk is paid for at base rate component of the Minimum Price)
FAT & PROTEIN	Every collection of milk	Milk Fat ≥ 3.30% m/v MINIMUM Protein ≥ 3.10% m/v MINIMUM	Refer to clause 11.3 of the Agreement. We may either reject or suspend collection of your Milk. If we do decide to reject or suspend collection then we will provide you with written notice of the reasons or the rejection or suspension, the consequences of the rejection or suspension and any associated costs for you to pay and any action plan that we require you to implement to ensure continuous improvement of milk composition.

	TEST FREQUENCY		TEST RESULT	PERCENTAGE (+/-)
BULK MILK CELL COUNT BMCC / SOMATIC CELL COUNT (SCC)	VIC/ SA/ TAS/ NSW	Every collection of milk	≤200,000 cells/mL	+3%
			201,000 – 300,000 cells/mL	0%
			301,000 – 400,000 cells/mL	-10%
			401,000 – 600,000 cells/mL	-20%
			>600,000 cells/mL	-30%
			We may exercise our rights in accordance with clause 11.3 of the Agreement and suspend collection if 5 results over a 30 day period are greater than 800,000 cells/mL	
	QLD	Every collection of milk	≤200,000 cells/mL	+3%
			200,000 - 250,000 cells/mL	+1.5%
			251,000 – 300,000 cells/mL	0%
			301,000 – 400,000 cells/mL	-5%
			401,000 – 500,000 cells/mL	-10%
			>500,000 cells/mL	-22%
	We may exercise our rights in accordance with clause 11.3 of the Agreement and suspend collection if 5 results over a 30 day period are greater than 800,000 cells/mL			
	WA	Every collection of milk	≤150,000 cells/mL	+5%
			151,000 – 200,000 cells/mL	+3%
			201,000 – 300,000 cells/mL	0%
			301,000 – 400,000 cells/mL	-10%
			401,000 – 600,000 cells/mL	-20%
			>600,000 cells/mL	-30%
	We may exercise our rights in accordance with clause 11.3 of the Agreement and suspend collection if 5 results over a 30 day period are greater than 800,000 cells/mL			
	BACTO SCAN ('Bacto')	Three times per month, at a minimum. Additional testing may be conducted to determine the source of a tanker with a high Bacto count	≤80,000 IBC/mL	0%
81,000 – 150,000 IBC/mL			-5%	
151,000 – 300,000 IBC/mL			-20%	
301,000 – 400,000 IBC/mL			-30%	
>400,000 IBC/mL			-40%	
We may exercise our rights in accordance with clause 11.3 of the Agreement and suspend collection if 5 results over a 30 day period are greater than 600,000 IBC/mL over a 30 day period				

	TEST FREQUENCY	TEST RESULT	PERCENTAGE (+/-)
Thermoduric (Thermo)	Once per month, at a minimum	≤2,000 cfu/mL	0%
		2,001 – 5,000 cfu/mL	-5%
		5,001 – 10,000 cfu/mL	-20%
		>10,000 cfu/mL	-30%
		We may exercise our rights in accordance with clause 11.3 of the Agreement and suspend collection if 5 results >15,000 cfu/mL over a 30 day period	
EXTRANEIOUS WATER / FREEZING POINT	Discretionary	≤-0.512°C	0%
		>-0.512°C	
	We may exercise our rights in accordance with clause 11.3 of the Agreement and suspend collection if 5 results > -0.512C over a 30 day period		
ACIDITY	Discretionary	≤0.14%	0%
		>0.14%	-100%
PH	Discretionary	≥6.6	0%
		<6.6	-100%
SEDIMENT / EXTRANEIOUS MATTER	Discretionary	Grade A or B	0%
		Grade C	-20%
		Grade D	-30%
PESTICIDES OR OTHER CHEMICAL CONTAMINANTS	Discretionary The dairy industry also conducts contaminant testing as part of the AMRA Survey	Below Australian MRL	0%
		Above Australian MRL	-100%
AFLATOXIN	At Lactalis' discretion The dairy industry also conducts aflatoxin testing as part of the AMRA Survey	≤0.50 ppb aflatoxin M1	0%
		>0.50 ppb aflatoxin M1	-100%

2.7 Application of Quality Requirement Adjustments Explained

BMCC

In Victoria, New South Wales, South Australia, Tasmania and Queensland, the first three BMCC results per month will be treated as “advisory tests” and the base rate component of the minimum price will be adjusted by +3% for the individual collections to which those first three BMCC results relate.

In WA, the first three BMCC results per month will be treated as “advisory tests” and the base rate component of the minimum price will be adjusted by +5% for the individual collections to which those first three BMCC results relate.

Subsequent adjustments will be applied as set out below.

VIC/SA/TAS/NSW

- a. Where the weighted average of the BMCC test results for the month is less than or equal to 200,000 cells/mL, then the base rate component of the minimum price will be adjusted by +3% in respect of all milk supplied in that the month.
- b. Where the weighted average for the month is greater than 200,000 cells/mL, then the base rate component of the minimum price for each collection of milk in that month will be adjusted by the percentage applicable to the test result range that the actual BMCC result falls within for that collection, as set out in the table above.

QLD

- a. Where the weighted average of the BMCC test results for the month is less than or equal to 200,000 cells/mL, then the base rate component of the minimum price will be adjusted by +3% in respect of all milk supplied in that month.
- b. Where the weighted average of the BMCC test results for the month is greater than 200,000 cells/mL but less than or equal to 250,000 cells/mL, then the base rate component of the minimum price will be adjusted by:
 - I. +1.5% for each collection during that month which has a BMCC test result of greater than 200,000 cells/mL but less than 250,000 cells/mL; and
 - II. +3% for each collection which has a BMCC test result less than or equal to 200,000 cells/mL during that month.
- c. Where the weighted average for the month is greater than 250,000 cells/mL, then the base rate component of the minimum price for each collection of milk in that month will be adjusted by the percentage applicable to the test result range that the actual BMCC result falls within for that collection, as set out in the table above.

WA

- a. Where the weighted average of the BMCC test results for the month is less than or equal to 150,000 cells/mL, then the base rate component of the minimum price will be adjusted by +5% in respect of all milk supplied in that month.
- b. Where the weighted average of the BMCC test results for the month is greater than 150,000 cells/mL but less than or equal to 200,000 cells/mL, then the base rate component of the minimum price will be adjusted by:
 - I. +3% for each collection during that month which has a BMCC test result of greater than 150,000 cells/mL but less than 200,000 cells/mL; and
 - II. +5% for each collection which has a BMCC test result less than or equal to 150,000 cells/mL during that month.
- c. Where the weighted average for the month is greater than 200,000 cells/mL, then the base rate component of the minimum price for each collection of milk in that month will be adjusted by the percentage applicable to the test result range that the actual BMCC result falls within for that collection, as set out in the table above.

Bacto

The first three Bacto test results per month will be treated as “advisory tests” and there will be no adjustment made to the base rate component of the minimum price in respect of those advisory tests. However, if you are on follow-up testing for Bacto that continues from one month into the next, you will not have any Bacto tests treated as “advisory tests” in that subsequent month until three consecutive results are $\leq 80,000$ IBC/mL.

Subsequent adjustments (being deductions only) will be applied to each individual collection according to the range that the actual result falls within, as set out in the table above.

Thermo

The first six Thermo test results per month will be treated as “advisory tests” and there will be no adjustment made to the base rate component of the minimum price in respect of those advisory tests. However, if you are on follow-up testing for Thermo that continues from one month into the next, you will not have any Bacto tests treated as “advisory tests” in that subsequent month until three consecutive results are $\leq 2,000$ cfu/mL.

Subsequent adjustments (being deductions only) will be applied to each individual collection according to the range that the actual result falls within, as set out in the table above.

2.8 Milk Temperature

Milk stored at greater than 5°C for any length of time increases bacterial activity, resulting in a reduction in milk quality. You are required to reduce the temperature of your milk to 5°C or less as quickly as possible, and maintain this temperature until the milk is collected.

Milk is required to be cooled to $\leq 5^\circ\text{C}$ within 2 hours and 20 minutes from completion of milking (“cups off time”) and maintained at that temperature until collected.

Milk cooling must be compliant with the industry standard ‘milk cooling curve’, as demonstrated in the table below.

TIME SINCE END OF MILKING	TEMPERATURE (°C)	
	ONE MILKING IN VAT	TWO OR MORE MILKINGS IN VAT
0 min	25.0	15.0
20 min	22.2	13.6
40 min	19.3	12.2
1 hr	16.5	10.8
1 hr 20 min	13.7	9.3
1 hr 40 min	10.8	7.9
2 hr	8.0	6.5
2 hr 20 min (and any time onwards)	5.0	5.0

Milk rejected by the tanker driver for failing a sensory test as a result of high storage temperatures will not be collected and may not be paid for.

You are not to place freshly-harvested milk on top of milk that has not been cooled and maintained at 5°C or below.

Milk will not be collected under any circumstances from storage vessels that are not refrigerated.

You are required to check your vat thermometer compared to a calibrated thermometer, such as the tanker thermometer.

You should check the temperature recorded on each tanker slip, SMS or Q&Q Statement and call us

if you believe the recorded temperature is incorrect.

IMPORTANT: A record of milking completion times must be clearly displayed in the milk vat room to allow the driver to complete a time/temperature assessment before collecting the milk. If the milk is over 5°C and the milking completion time is not displayed, the milk may not be collected.

Vat Temperature Monitoring

We encourage you to install a real time vat monitoring device to provide alerts if cooling issues arise, but also ask you to ensure any such device is compliant with our milk data management requirements. Please contact your Supplier Relationship Manager for these requirements.

2.9 Age of Milk

Milk which has been harvested in excess of 48 hours prior to collection will not be collected without the prior approval of the National Milk Quality Manager.

2.10 Bactoscan (Bacto)

The Bacto test measures the total number of bacteria present per millilitre of milk. Bacterial contamination of milk is the main cause of milk and product spoilage. For pasteurised milk to achieve the “Use By” date, it is necessary to start with a clean raw product.

Milk is tested for Bacto at a minimum of 3 times per month. Milk is expected to be $\leq 80,000$ IBC/mL.

Any Supplier whose milk returns a result of $> 80,000$ IBC/mL will be subject to follow-up testing on the next samples collected from the farm, until three consecutive results $\leq 80,000$ IBC/mL are received.

Additional testing may be conducted to determine the source of a tanker with a high Bacto count.

If a Supplier has a two-month Bacto rolling geometric mean of greater than 456,000 IBC/mL (TPC equivalent of 100,000 cfu/mL) Lactalis will contact the Supplier in writing and advise that the two-month Bacto rolling geometric mean must be reduced below 456,000 IBC, otherwise collection may be suspended.

2.11 Thermoduric (Thermo)

The Thermo test is completed at a minimum of once per month. The test is designed to detect heat-resistant types of bacteria in milk. The milk sample is pasteurised so that only the heat-resistant bacteria remain, then the sample is plated and incubated for 72 hours (three days). This means that the test result is available three days after a Supplier’s milk sample arrives at the testing laboratory.

As Thermo can survive pasteurisation and product processing, they have the ability to cause spoilage in dairy products, resulting in a reduced shelf life. Milk is expected to be $\leq 2,000$ cfu/mL.

Results of $> 2,000$ cfu/mL will be subject to follow-up testing on the next samples collected from the farm, until three consecutive results $\leq 2,000$ cfu/mL are received.

2.12 Bulk Milk Cell Count (BMCC)

The BMCC test, measures the number of white blood cells in milk, which is essentially measuring the level of infection in the udder. These cells are called somatic cells and can be referred to as SCC.

Mastitis is an infection of the udder, and both ICCCs and BMCC can be used to monitor the level of mastitis infections in a herd.

Milk with a BMCC over 400,000 cells/mL is deemed unfit for human consumption by many global markets. Suppliers are encouraged to contact their Supplier Relationship Manager if they need assistance to improve their BMCC through the adoption of a mastitis control program.

A Supplier’s milk is tested for BMCC on every collection. For payment purposes, BMCC averages are rounded to the nearest 1,000 cells/mL.

If BMCC is consistently greater than 400,000 cells/mL, a Lactalis representative will liaise with the Supplier to work towards reducing BMCC to an acceptable level as required by regulatory requirements and the Countdown Downunder program.

If a Supplier has a three-month BMCC rolling geometric mean of 400,000 cells/mL or above, Lactalis will contact the Supplier in writing and advise that the three-month BMCC rolling geometric mean must be reduced below 400,000 cells/mL, otherwise collection may be suspended.

2.13 Antibiotics (Inhibitory Substances)

The occurrence of any form of antibiotic above the legal MRLs in our milk supply, when tested using a recognised Australian test method, automatically renders that milk unsuitable for processing.

Milk Vat Antibiotic Contamination

It is your responsibility to inform us of possible or probable antibiotic residues in any milk BEFORE the tanker arrives on farm. You must also place a sign on all suspect vats to eliminate the possibility of accidental collection. If you suspect that contamination has occurred you can contact your Supplier Relationship Manager who will provide you with instruction regarding testing and collection. It is your responsibility to ensure that milk samples are transported to an appropriate testing facility for DELVO T testing.

Any milk that subsequently tests positive for antibiotic residues must be measured and dumped.

Milk Tanker Antibiotic Contamination

All milk tankers are tested by a rapid antibiotic screen test on arrival at the factory. Should a positive result be detected on the tanker, the tanker is segregated while the recognised official DELVO T test is conducted. Each Supplier's vat sample is then checked for the presence of antibiotics and the offending Supplier is notified. It is the offending Supplier's responsibility to have the next collection of milk tested and declared negative by DELVO T test before the next tanker collection can proceed.

If antibiotics are present in the milk tanker with NO PRIOR NOTIFICATION of possible or probable residues in milk there may not be payment for the full collection of the contaminated milk and we may recover from you costs associated with:

- a. Additional testing, segregation, extra transport and processing/disposal of the contaminated collection
- b. Demurrage charge for the cost of the tanker being held up for the duration of the recognised Australian standard broad spectrum antibiotic test e.g. DELVO T, which is approximately three hours
- c. The actual net value of the other Suppliers' milk
- d. Cartage

Please note: The Supplier can obtain insurance to cover any loss or damage it may cause (including any costs payable to Lactalis in the event of milk contamination). We recommend that you speak to an insurance broker about your options.

Where a Supplier's milk has tested positive for antibiotics through any routine testing procedures (e.g. "rapid test" or Australian standard test), Lactalis may conduct an audit to determine the cause of the issue.

Calving Cows

You should be cautious when introducing large numbers of freshly calved cows back into the herd if they have been treated with dry cow therapy. Some treatments assume a small number of cows are introduced at any one time when setting withholding periods.

2.14 Extraneous Water/Freezing Point

All milk supplied to Lactalis must be free of extraneous (added) water. The average freezing point of cow's milk is approximately -0.525°C and the freezing point of pure water is 0°C . The addition of water to milk increases the freezing point on a linear scale.

The freezing point standard adopted by Lactalis and most processors and dairy authorities is -0.517°C maximum. Compliance with this standard is essential but we will allow latitude up to -0.512°C until otherwise advised.

2.15 Acidity and pH

Acidity is measured as a percentage of lactic acid present in the milk sample.

The pH of milk is 6.7; milk is tested to determine any change in pH which may be acid or alkaline in nature.

We will conduct acidity and pH analysis at our discretion. These tests are generally conducted if there is some doubt as to the milk quality (cooling rate during storage), age of milk or potential contamination with chemicals, however they are not limited to these circumstances.

2.16 Sediment

Milk is to be free of sediment and foreign matter.

2.17 Chemical Standards and General Milk Quality Standards

Chemicals used in the operation of the dairy and coming into either direct or indirect contact with milk, e.g. lubricants, cleaning chemicals, rubber-ware and coolants must be classed as "Food Grade" and able to be verified as "Food Grade".

Any chemicals used in the operation of the dairy, e.g. pesticides, lubricants, cleaning chemicals and coolants must be stored and used in a way that ensures the milk is protected from contamination.

Chemicals used to clean milking plants must indicate on the label that they are listed for cleaning contact surfaces in a dairy plant.

Prohibited Chemicals

Cleaning chemicals which contain Quaternary Ammonium Compounds and teat sprays/dips which contain Nonylphenol Ethoxylates NPEs as surfactants are prohibited for use.

Iodine

The iodine level in milk will be tested at our discretion and if the result is greater than the standard of $500\ \mu\text{g/L}$ you may be monitored more frequently. We will work with you to reduce iodine to the levels required by Australian MRLs.

The use of unregistered pre-milking teat disinfectants is strictly prohibited.

Any iodine products must be used strictly in accordance with the manufacturer's instructions.

Pesticide (Chemical) Detection

If you suspect that your milk may be contaminated with a pesticide or other chemical contaminant you must notify us immediately. If you are unable to contact your Supplier Relationship Manager, the carrier must be notified and the milk must be measured and then dumped.

If pesticides or other chemical residues above the Australian MRL are detected in your milk then we may exercise our rights in accordance with clause 11.3 of the Agreement and suspend collection until the matter is rectified.

Aflatoxin

We conduct monitoring of raw milk for aflatoxins, as does other dairy industry bodies. Aflatoxin is a compound that can be toxic when consumed by mammals. If aflatoxin is consumed by dairy cattle, a small amount of a less toxic form of aflatoxin is secreted into milk resulting in a milk residue.

Feed can be contaminated with aflatoxin as a result of mould growth which may occur pre-harvest or while in storage.

The Agricultural Standards Act 1994 (Qld) and the Agricultural Standards Regulation 1997 (Qld) set stock food standards that limit contamination to: $0.20\ \text{mg}$ aflatoxin B1/kg in peanut by-products; 0.02

mg aflatoxin B1/kg in grain; 0.05 mg/kg in stock food for beef cattle, horses and sheep, 0.02 mg aflatoxin B1/kg in stock food for dairy cattle; and various levels in stock food for other classes of stock.

In the absence of a quantitative “MRL/ML” for aflatoxin in milk, Lactalis, in consultation with the dairy industry, regards the acceptable level of detection as less than 0.50 ppb aflatoxin M1 in raw milk.

We expect all Suppliers nationally to comply with the standards imposed by the Agricultural Standards Act 1994 (Qld) and the Agricultural Standards Regulation 1997 (Qld).

GMOs

Our policy is to avoid the use of GE or GM materials whenever possible. For example, the ingredients that we use in our products are purchased against documented assurances as to their non-GE/GM status.

Our preference is that Suppliers avoid GE/GM feed for their cows whenever possible. However, we recognise that there are times when feed of non-GE/GM status is either in extremely short supply or that the cost of non-GE/GM feed is prohibitive given economic realities. In such times, and especially in periods of drought, we accept that feed containing GE/ GM substances may have to be used. When situations return to normal availability of feed, we expect that you will do all in your power to avoid the purchase of feed containing GE/GM materials.

Enzootic Bovine Leucosis (EBL)

Dairy Australia monitor EBL Free Status via bulk milk testing of dairy herds and provide a national annual report to demonstrate maintenance of EBL Freedom to international trading partners. Any detections of infection are reported to the relevant state Chief Veterinary Officer to follow up on eradication actions.

Milk samples for bulk milk testing must be provided to Lactalis on request.

It is important to be aware that some beef herds in Australia may still have a low level of EBL, so any dairy farmers considering introduction of beef bulls or other beef animals must ensure that they are coming from properties free of the disease.

You are required to maintain biosecurity controls that prevent the introduction of EBL to your herd by:

- a. Isolating any introduced beef animals from the dairy herd until they have tested clear of EBL;
- b. Ensuring that no unsterilized implements are used on the dairy herd that have previously been used for procedures on beef cattle such as ear tagging, castration or dehorning.

Oestradiol Restrictions

In 2008, the Australian dairy industry introduced a voluntary restriction on the use of oestradiol benzoate in lactating dairy cows. This was due to changes in export market regulations in which some countries banned the importation of dairy products that have been treated with oestrogens, including oestradiol.

It is a condition of supply that you do not treat lactating animals with oestradiol.

Oestradiol is still permitted to be used for oestrus synchrony programs in non-lactating heifers, however it cannot be used in lactating cattle. Suppliers should discuss alternative options for the treatment of non- cycling cows with their veterinarian.

Recombinant Bovine Somatotropin (rbST)

Bovine Somatotropin (bST), also known as Bovine Growth Hormone (BGH), is a naturally-occurring peptide hormone which is produced in the pituitary gland of the cow. A synthetic version of bST, rbST, is produced via biotechnological processes and is used in some countries to increase milk production and feed efficiency.

In Australia, as at 1 April 2020, no rbST product is registered for sale or approved for use for any species.

Suppliers must not use rbST on the farm.

2.18 Testing Results

We will notify you as soon as practicable after we test of all results. You must ensure that we are able to contact you at all times.

Daily Q&Q Statements are e-mailed each afternoon, containing all results currently available for that month to date. Preliminary monthly Q&Q Statements are sent on or about the second day of the following month and final Q&Q Statements are sent on or about the fifth day of the following month.

Results are also available on the Milk Supply website (<https://farmers.parmalat.com.au>), via SMS and on milk tanker dockets. Results are communicated once we receive them from the external laboratory. SMS are sent within the hour of result receipt.

2.19 Payment for Milk Not Collected when Notified of Potential Issues

Where you suspect that your milk does not meet the Quality Requirements and you notify us of such an event prior to collection and we subsequently elect not to collect that milk, then we will pay the base rate component of the Minimum Price for that volume of milk we have elected not to collect, for the first occurrence per year of the Supply Period.

Milk not for collection by a tanker (including colostrum vats/tanks) must clearly be labelled NOT FOR COLLECTION BY TANKER. You must ensure it is labelled prior to the next milk collection.

All test results for rejected milk remain our property.

2.20 External Auditing

Milk will only be collected from milking premises that comply with these Quality Requirements and maintain compliance at all times with all relevant state and federal legislation, such as dairy licence.

You will be audited for compliance every two years at a MINIMUM by an external auditor. Depending on the result of the audit Lactalis and State Authorities may require audits to be completed on a more frequent basis. You may also be audited for other purposes.

We will cover the cost of one external audit every 2 years per farm by an auditor approved by us. You will be responsible for all additional fees associated with for example, an increase in the frequency of audits, return visits to the farm by the auditor to close out non-conformances or non-conformances being closed out by the auditor off-farm.

We will also charge you any audit cancellation fees. Audits cancelled within one week of the notified audit date will incur a charge equal to 25% of the audit cost. Audits cancelled within one day of the notified audit date, or a no-show on the day of the audit will incur a charge equal to 50% of the audit cost.

- a. Audit cost \$400.50
- b. On-farm non-conformance clearance cost \$302.50 per audit
- c. Off-farm non-conformance clearance cost \$110 per audit

As part of the audit process, auditors may take photos of your records and the premises. The photos will be only used for the purposes of the audit and reporting to us. The photos will be stored securely on both the auditor's system and Lactalis' system in accordance with our privacy policies.

In accordance with clause 11 of the Agreement, collection may cease as the result of a critical non-conformance relating to food safety or quality.

In addition, the external auditor may classify the non-conformance as follows and require you to provide evidence of effective corrective action. The external auditor will provide you with a period of time (depending on the nature of the non-conformance), to instigate and implement corrective action.

Minor non-conformance - Not likely to lead to the production or supply of unacceptable milk.

Major non-conformance - May lead to the production or supply of unacceptable milk.

Critical non-conformance - Presents an imminent and serious risk to the safety of milk.

If the audit uncovers a non-conformance that presents an imminent and serious risk to the safety of

the milk then then we and / or the approved auditor may be required to immediately contact the state authorities to advise them of the circumstances warranting the issue of a critical CAR. The state regulator will work with you to close out the critical CAR additional to any action that we may take in accordance with the terms of the Agreement and advise the approved auditor and/or us of the action taken to rectify the non- conformance.

A CAR will be issued by the approved auditor where there is an identified minor non-conformance, major non-conformance or critical non-conformance. If the CAR is not closed out by the agreed date, the approved auditor will review the reasons why and, depending on the approved auditor’s view of your non-conformance with the Agreement and this Handbook, may take one of the following actions:

- a. Issue a new close out date determined by the approved auditor; or
- b. Determine that you have failed to satisfactorily implement the systems and requirements described in the Handbook, close the current CAR and raise a new CAR at an increased severity level.

Where more than one related minor or major non-conformances are raised which collectively are likely to compromise food safety, the non-conformances may be classified as major or critical.

Where practical, a minor or major CAR may be closed out remotely by sighting sufficient documentary or photographic evidence without attending the premises.

In the case of Queensland Suppliers, the following also applies:

In relation to the approved performance based auditing, you (Accreditation Holders) will be assessed into one of two categories set out below.

Category allocation/reallocation will be based on quality and audit results for the preceding financial year (year ending 30 June). Allocation will take place when these results are finalised. You will be notified of your category status and next audit on your monthly Q&Q Statements.

If you are new to supplying us, or a supplier returning after a break in supply to us, you will be required to have supplied for a minimum of one full financial year before being allocated to a category. During this period you will receive annual audits and your category status will appear on your monthly Q&Q Statements as category 2.

In the event of a dispute over category allocation, you will default to annual audit (category 2).

Category 1: Two Year Compliance Audits

You must attain the following quality results and audit rating over the preceding financial year to be eligible for two year compliance audits.

QUALITY RESULTS	
Antibiotic	No recorded antibiotic incidents on tanker (and traced back to Supplier) detected by DELVO T
Total Plate Count	All monthly averages less than or equal to 50,000 cfu/mL
BMCC	Annual average less than or equal to 400,000 cells/mL
Temperature	Less than or equal to 5.0°C - No more than 6 pickups greater than 5.0°C for the year provided they are recorded within approved pickup times

Audit Rating

Critical Nil

Major non-conformances 1 only.

Category 2: Compliance Audits at 12 Month Intervals

If you do not reach the requirements of category 1, you default to this category.

Auditing and Reporting Requirements

Critical, and major non-conformances are defined in Section 49, Food Production (Safety) Regulation 2014.

Safe Food Queensland has the right and responsibility to conduct check audits at their discretion, with or without prior notification. If critical or major non-conformances are identified in check audits, follow-up audits will be conducted by Safe Food Queensland and these will be at your cost.

In the case of New South Wales Suppliers, the following also applies:

The NSW Food Authority uses a rating system to rank audit performance. CARs identified during audits can be rated as minor, major or critical, depending on their severity. Each CAR attracts a numerical value, with a minor CAR worth 2 points, a major CAR worth 8 points and a Critical CAR worth 64 points. The total points of all the CARs raised at the audit determines the facility rating and audit frequency as shown in the below table.

FACILITY RATING	CUMULATIVE CAR SCORE	AUDIT RESULT	AUDIT FREQUENCY
A	0 – 15	Pass	2 yearly
B	16 – 31	Pass	12 monthly
C	32 – 47	Marginal	6 monthly
D	48 – 63	Failure	1 month
E	64+	Failure	1 month

The audit result and rating is communicated to you at the end of the audit and will also be recorded on the audit report. The facility rating determines the audit frequency.

We may exchange information with the NSW Food Authority.

3. Our Agreed Responsibilities

Our Agreed Responsibilities is a summary of the set of standards and behaviours we expect from everyone involved in our business, including employees, contractors and you - our farmers that supply us milk.

It is important as a Supplier to Lactalis that you understand what we stand for and how we like to conduct our business. This policy has been specifically developed to compliment Lactalis' core values and vision of trust, integrity, ethics and social responsibilities.

Lactalis is committed to being a responsible corporate citizen and we look for suppliers that will adhere to all applicable laws and regulations. We expect all of our suppliers to uphold and respect human rights, fair working conditions, environmental protection and animal welfare principles in all business activities.

3.1 Work Health and Safety

Health and safety are fundamental to the way Lactalis conducts business. We are guided by the principle that no job is ever so urgent or important not to take the time to do it safely and that all accidents, workplace injuries and workplace illnesses are preventable by implementing food, work, health and safety management practices.

We expect you to follow standards, policies and operating procedures around your dairy farm and continue to be aware of ongoing or new hazards and unsafe practices.

3.2 Social and Ethical Policy

In accordance with the expectations of our customers, trade partners, the public community at large and the requirements of legislative authorities; we endeavour to always operate responsibly within the community and we expect the same from our suppliers. Lactalis fully supports the United Nations Framework and Guiding Principles in Business and Human Rights and as a minimum we expect suppliers to adhere to the following principles:-

- a. **Bribery and Corruption** Suppliers will not engage in acts of bribery and/or corruption, including falsifying documents and records relating to the business.
- b. **Discrimination** Suppliers will not engage in discrimination in hiring, compensation, access to training, promotion, termination or retirement based on race, caste, national origin, religion, age, disability, gender, marital status and sexual orientation.
- c. **Harsh or Inhumane Treatment** As an ethical and moral organisation, we prohibit and do not tolerate physical abuse, the threat of physical abuse, sexual harassment, verbal abuse (including swearing) or other forms of intimidation.
- d. **Employment Law** Suppliers will ensure to every extent possible, that work performed must be on the basis of recognised employment relationships, established through national laws and practices.
- e. **Modern Slavery and Human Rights** The risk of modern slavery in the Agriculture Industry is considered high by the International Labour Organisation. Suppliers will comply with all applicable anti-slavery and human rights laws, including;
 - i. the Modern Slavery Act 2018 (Cth);
 - ii. Division 270 and 271 of the Criminal Code Act 1995 (Cth);
 - iii. any other applicable law which prohibits exploitation of a worker, human trafficking, slavery, slavery-like behaviour, servitude, forced labour, child labour, debt bondage or deceptive recruiting for labour or services (or similar);
- f. **Conditions of work** The Supplier agrees to negotiate and document in writing terms of employment or engagement for its workforce. The Supplier agrees to comply with all applicable laws, including minimum wage, hours, overtime, maximum hours and provide mandated benefits

in accordance with legislation.

3.3 Whistleblower Policy

We encourage you to report any wrongdoing that may cause Lactalis financial or non-financial loss or damage to our reputation or harm to others. Our Whistleblowing Policy aims to establish an effective reporting and investigation mechanism and allows those with concerns to raise their concerns confidentially and without fear of reprisal.

All reports will be taken seriously and treated confidentially to the maximum extent possible. Our whistleblower policy can be found at annexure a of this handbook.

3.4 Corporate Image

Maintaining a reputation for consistently high legal, moral, ethical and socially responsible standards, and expectations in our dealings with our customers and other stakeholders is critical for our ongoing success.

The Supplier acknowledges that business reputation is important to Lactalis and that as a supplier to Lactalis its actions can reflect on the reputation of our business and relationships with other suppliers and customers.

3.5 Farm Presentation

The appearance of Lactalis' Suppliers' farms is very important to Lactalis, the public and our customers. Given our Suppliers' farms are essentially a food manufacturing facility, we ask that the presentation of our Suppliers' farms reflects the milk quality and food safety standards we all strive for.

Our Suppliers must maintain the following aspects of their premises to ensure a high standard at all times:

- a. The farm entrance and tanker turn-around areas must be kept in a clean and tidy manner, with fences maintained, free of rubbish, well gravelled driveways free of potholes and no excessive weed build-up.
- b. The Milkroom and dairy must be clean and tidy and in good repair, with measures in place to manage vermin, birds and insects.
- c. Calf and cattle handling facilities close to the dairy must be clean
- d. Effluent must be washed from all dairy surfaces daily and the effluent system must be in working order with no dairy effluent leaving the property.

3.6 Environment

Lactalis is committed to understanding and minimising any adverse environmental impacts of our activities and recognising our key areas of environmental improvement. Suppliers should always be compliant with applicable legislation and be able to demonstrate responsible practices and continuous improvement around environmental management.

3.7 Animal Health

Animals must be managed in a manner which prevents the introduction of hazards to the milk. An unhealthy animal could be defined as one which exhibits any unusual symptoms of disease or suspect behaviour. Single occurrences of animals exhibiting unusual symptoms of disease, suspect behaviour or unexplained deaths may simply be part of normal farm operations. However, if in doubt, it is the

Supplier's responsibility to assess the situation and, where relevant, report to the appropriate authorities.

Should Suppliers notice such symptoms, they are required to contact their Supplier Relationship Manager immediately. Any cows showing signs of illness must be immediately removed from the

milking herd to ensure that their milk is not mixed in with milk from healthy animals. Suppliers should keep suspect animals isolated and contained on their property.

Lactalis may suspend collection of milk where there is a non-compliance.

Lactalis may conduct an audit of the farms' compliance with the Agreement to determine the cause of any issue and will liaise with the relevant authorities (as appropriate) in such instances.

Some diseases and hazards to check for include:

- a. Foot and Mouth Disease;
- b. Botulism;
- c. Pesticide poisoning;
- d. Poisonous plants.

3.8 Animal Welfare

Corporate Social Responsibility – Lactalis Group Animal Welfare Policy

At Lactalis, contributing to animal welfare is not only our responsibility, but also a cornerstone for the sustainability of the company's activities.

Our vision: we strive to advance our approach on animal welfare to ensure that animals have a good life, help to improve the performance of our partnering farms, meet the expectations of our stakeholders and preserve the sustainability of our supply chain.

As a first step, Lactalis Group is initially focusing our efforts on our direct volumes in 8 pilot countries (of which Australia is one) and on 10 animal welfare topics. The full policy, including our approach and ambitions, is at Annexure B. If there is any inconsistency between Lactalis' policy and any industry policies on animal welfare, the Lactalis policy prevails to the extent of any inconsistency.

Our commitments and positions:

TRANSVERSE	
Lactalis on-farm assessments	100% of our direct volumes will have on-farm assessments on animal welfare by 2025 - With a once every 3 years frequency - In the context of a Lactalis Animal Welfare Assessment Program that will be defined by the end of 2022 in collaboration with recognised third parties such as universities and non-governmental organisations
Lactalis staff trainings	100% of our Supplier Services Team will be trained in animal welfare by 2023 - With a once every 3 years frequency - With external, industry recognised training
PER PRACTICE	
<i>Close confinement and intensive systems for livestock</i>	
Tethering	Lactalis encourages loose housing systems and is committed to raising farmers' awareness not to build new tethering barns
Bedding space	Farms supplying milk to Lactalis should provide cows with satisfying bedding space
Calves in groups	Lactalis promotes group housing for calves from 4 weeks of age
	In European Union countries, the UK, Australia and Brazil, all dairy calves within Lactalis supply chain must be reared in groups from at least 8 weeks of age
<i>Effective species-specific environmental enrichment</i>	
Access to pasture	Lactalis encourages pasture grazing whenever feasible, under local conditions
Effective species-specific environmental enrichment	Lactalis encourages partnering farms to implement enrichment tools to give animals the opportunity to express their natural behaviours
<i>Growth promoting substances</i>	
Growth Hormones	In European Union countries, the UK, Australia and the USA, growth hormones are not permitted within Lactalis supply chain
<i>Antibiotics for prophylactic use</i>	
Antibiotics	Lactalis aims to fight against antimicrobial resistance and supports partnering farms to reduce prophylactic use of antibiotics (including blanket dry cow)
<i>Routine mutilations</i>	
Disbudding/Dehorning	Lactalis promotes recognised best practices for disbudding and will eliminate routine dehorning (>8 weeks of age) by 2025
Tail Docking	Practicing routine tail docking is not permitted within Lactalis Supply Chain.
<i>Other</i>	
Animal derived proteins in feed	All Lactalis partnering farms must comply with national regulations regarding the use of animal derived proteins in dairy animal feed. In European Union countries and Australia, according to local regulations, this practice is strictly forbidden for ruminants.

Lactalis direct Suppliers will be measured against the above commitments as part of the 3-yearly assessments. Non-compliance with any of the commitments will be addressed with the Supplier and an action plan towards compliance will be required.

Industry Welfare Priorities and Policies

Lactalis strongly supports the Australian dairy industry position on animal welfare and works closely with Dairy Australia and other relevant industry bodies.

Australian Animal Welfare Standards and Guidelines – Cattle

Australian Animal Welfare Standards and Guidelines for Cattle have been developed by the Australian and State governments in consultation with ADF, Dairy Australia, other livestock organisations and animal welfare groups.

The standards are legal requirements that must be met by all dairy farmers. Following endorsement,

they will need to be implemented through State and Territory regulation, and they will replace the Codes of Practice for Cattle that previously operated at State and Territory level. If farmers do not comply, they will face the risk of legal action and financial penalties.

The standards cover the full range of on-farm management practices for cattle, and their welfare. These include:

- a. Feed and water;
- b. Risk management;
- c. Handling;
- d. Castration and dehorning;
- e. Breeding;
- f. Calf rearing systems;
- g. Dairy management;
- h. Humane killing / euthanasia.

The Supplier must ensure they are meeting the standards. For more on this, Dairy Australia have created a guide for dairy farmers: Australian Animal Welfare Standards – a guide for dairy farmers <https://www.dairyaustralia.com.au/farm/animal-management/animal-welfare>

Policy directives from the Australian Dairy Farmers' Animal Health and Welfare Policy Advisory Group include:

- a. Phase-out calving induction by 2022
- b. Provision of pain relief for all calves during disbudding, which must occur under the age of 2 months
- c. No euthanasia of calves by blunt force trauma
- d. No tail docking

Lactalis supports the industry's approach and, as such, we require compliance from all Suppliers. Audits may monitor the adoption of these policies on individual farms.

Australian Animal Welfare Standards and Guidelines – Land Transport of Livestock

The dairy industry has worked with other industry bodies, animal welfare scientists, governments and welfare groups to develop new national standards for the transport of animals. The Australian Animal Welfare Standards and Guidelines – Land Transport of Livestock form part of State legislation. These standards protect the welfare of animals being transported and provide consistent regulation around Australia. The standards cover responsibility for the assembling and preparation of livestock for transport, assessment of fitness for the intended journey, feed and water provisions, and holding periods prior to loading.

For more on this, Animal Health Australia maintain the website below: <http://www.animalwelfarestandards.net.au/land-transport/>

4. Transport

4.1 Farm to Factory Transport and Collection Requirements

We are responsible for arranging routine milk collection.

Collection of Part Vats or Silos

At the time of milk collection it is a requirement that collection includes the entire volume of milk in each vat or silo. It is not acceptable for part vats/silos to be collected, leaving a remaining volume in a vat

or silo. Exceptions to this rule can only be made with the prior written approval of the Supplier Relationship Manager or nominee.

Procedure at Farm

You must have clear concise written procedures for the tanker drivers displayed in the dairy. This includes vat wash instructions. All switches need to be clearly labelled.

Milk Collection Queries and Concerns

We consider direct contact between you and the transport carrier to be important in day-to-day management of milk collection. If you have any problems that are transport related (e.g. extra pickups due to flood or other reasons), then please phone your Supplier Relationship Manager or the carrier as soon as you become aware of the problem.

If you have any questions or concerns relating to individual pickup please put them in writing to your Supplier Relationship Manager as early as possible but within five working days (maximum) following the end of the month of concern.

Any transport related quality issues must be referred to your Supplier Relationship Manager for resolution. These include such issues as hot milk and suspected antibiotics.

Collection Frequency Requirement

Consistent with industry, we prefer you to have sufficient vat capacity for milk harvested over a two day period.

Additional Freight Charges

We remain responsible for the cost of normal milk collection except for in the following circumstances:

If you require extra collections because of situations such as, but not limited to, vat breakdowns, power failures or insufficient vat capacity, please let us know as soon as possible. Upon our agreement, additional collections may be arranged, for which a \$40 collection charge will apply. Second collection charges will not be applied if the farm is supplying above 25,000 litres per day.

In cases where a carrier collects milk on a daily basis to address a tanker capacity issue rather than due to insufficient vat capacity on farm, an additional charge will not be applied.

Loss for Milk Not Collected

We will not be responsible for any loss that you may incur due to:

- a. adverse weather conditions (e.g. flooding, fire etc); or
- b. road access issues, specifically a lack of adequate road access to a farm; or
- c. government authorities restricting farm access for public health or safety reasons; or
- d. the tanker being unable to access the farm for any reason; or
- e. the milk being contaminated or unsuitable for collection.

You are advised and encouraged to insure against such events.

We are happy to assist with any information required for you to make a claim on your insurance.

For milk which has been dumped on farm due to the presence of antibiotics, a letter for insurance purposes will only be provided if we have approved of the dumping of that milk.

Tanker Access

To reduce the instances of possible damage or loss, we rely on you to advise the carrier if there are any foreseeable problems that may prevent or reduce tanker access. An access road from the property front entrance to the dairy turnaround area must be free of obstacles (obstacles include all farm equipment, pets, cars, push bikes, or anything which may inhibit the free operation of the milk collection process).

Cattle or any other livestock must also be excluded from the driveway and turnaround. This is not only a safety issue, but also a potential food safety issue, as there are aspects which could see the transfer of disease from one farm to another via trucks if there are animals or their waste on the tanker road.

You are reminded of the necessity for 24-hour all-weather access to the property. This includes ensuring that any bridges on the farm are structurally sound and can bear the load of a milk tanker.

Tanker Entrance and Turnaround Design (B Double Access): If you are planning to upgrade tanker access the following diagram provides the recommended specifications for a 25-metre B Double tanker turnaround design. Recommended turnaround design specifications for all tanker configurations are

provided in the table below (minimum specifications are provided in brackets). Note that reducing the tanker turning circle below the recommended measurements increases the risk of damage to tankers and tracks.

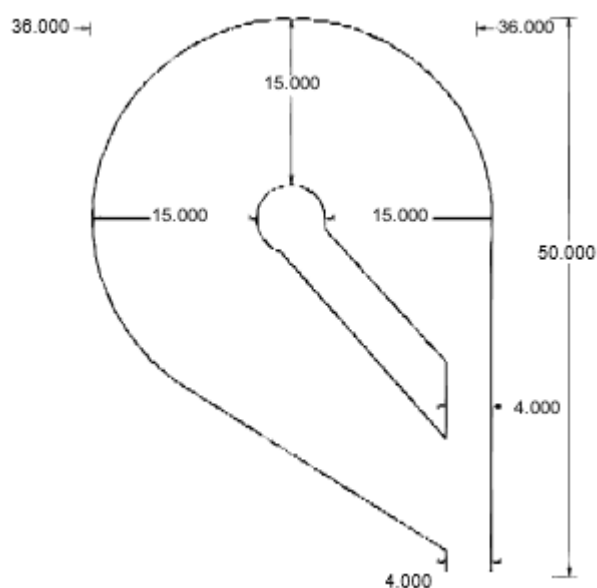

	FARM ENTRANCE		TANKER TURNAROUND AREA			
	SPLAY (M)	DISTANCE FROM ROAD (M)	LENGTH (M)	WIDTH (M)	TRACK WIDTH ON TURN (M)	TRACK WIDTH ON STRAIGHT (M)
25 m B Double	50 (50)	21 (21)	50 (45)	35 (30)	15 (12)	4 (3.5)
19 m B Double	50 (22)	21 (18)	50 (45)	30 (25)	10 (8)	4 (3.5)
15 m Tri-Axle	50 (18)	21 (16)	50 (45)	25 (22)	10 (8)	4 (3.5)

Dairy Access

We require suitable access to your farm to perform tasks around safe milk collection such as:

- to inspect and discuss any workplace safety issues for our carriers and Lactalis staff
- to help rectify milk quality issues.

In order to guarantee safety of individuals and property, tankers should not be required to reverse up to or away from vat rooms or dairies.

You are encouraged to contact your local transport carrier for assistance in designing tanker access.

Removal of On-Farm Obstacles

For carriers to deliver a cost-efficient, timely service to you, carriers will be asked to identify on-farm obstacles. Some examples of obstacles include insufficient turning room for tankers, overhanging trees, farm equipment etc.

You will be given a reasonable amount of time to rectify an issue. We may suspend collection where there is a non-compliance.

Contacts

See website for Lactalis Milk Supply Team and local logistics contacts.

www.lactalis.com.au



National Milk Supply

Lactalis Australia Pty Ltd

ABN 56 072 928 879

P.O. Box 3012 South Brisbane QLD 4101

NationalMilkSupply@au.lactalis.com

ANNEXURE A - WHISTLEBLOWER POLICY



**LACTALIS AUSTRALIA PTY LTD
WHISTLEBLOWER POLICY**

As approved by the Board of Directors

LACTALIS AUSTRALIA PTY LTD WHISTLEBLOWER POLICY

1. Purpose of this whistleblower policy

Lactalis Australia Pty Ltd (Lactalis) as a member of the Lactalis group, is committed to ensuring Lactalis and all its officers and employees, act at all times in compliance with all laws and to the highest standards of personal and corporate ethics, as set out in the corporate Code of Conduct.

Lactalis operates a number of policies, practices and controls to maintain the high level of compliance and ethics expected. It recognises though that any genuine commitment to detecting and preventing illegal and other undesirable conduct must include, as a fundamental cornerstone, a mechanism whereby employees and others can report their concerns freely and without fear of repercussion.

This policy provides such a mechanism, and the policy and contact details for the Protected Disclosure Officers will be made available to, and be easily accessible to officers, employees, contractors, suppliers, customers and the general public via the Lactalis intranet and website (www.lactalis.com.au) and in such other ways to ensure the policy is available to all officers and employees.

Through application of this policy Lactalis aims to achieve the following benefits:

- a. more effective compliance with laws;
- b. more efficient fiscal management;
- c. more effective management;
- d. improved morale; and
- e. a living record of the fact that Lactalis takes its governance obligations seriously.

2. Implementation

The Lactalis Australia Whistleblower Policy and contact details for the Protected Disclosure Officers will be made available to, and be easily accessible to officers, employees, contractors, suppliers, customers and the general public on:

- a. The company website; and
- b. The internal company intranet.

3. Who may invoke this policy?

This policy applies to:

- a. all officers and employees (Staff) of Lactalis, its subsidiaries and related parties;

- b. contractors or suppliers to Lactalis; and
- c. a spouse, dependant, relative, or dependant of a spouse of any person set out in sections 3.a. and 3.b..

4. What types of matters should be reported under this policy?

A person referred to in Section 3 may make a report in respect of any Reportable Conduct. Reportable Conduct is any conduct by any person employed by, who holds an office in, or is otherwise connected with, Lactalis, which in the view of the whistleblower, acting in good faith, is:

- a. corrupt or dishonest;
- b. fraudulent;
- c. illegal, unlawful or contrary to any state or federal legislation;
- d. unethical or in breach of Lactalis policies;
- e. constitutes an abuse of authority;
- f. serious improper conduct; or
- g. any other conduct which may cause loss to Lactalis, or otherwise may be detrimental to its interests.

This policy does not apply to personal work-related grievances. Personal work-related grievances are matters which relate to a person's employment or former employment with Lactalis and which have implications only for that person individually and therefore do not qualify for protection under the Corporations Act and are not Reportable Conduct. Personal work-related grievances are matters that should be addressed with the Company's Human Resources Team.

5. How can a matter be reported?

Reports are able to be made in writing, by telephone or by email. Reports may be made to Lactalis' Protected Disclosure Officers, who are:

General Manager Legal
Jacqui Bayles

Phone: 07 3840 0187
Email: jacqui.bayles@au.lactalis.com

General Manager Human Resources
Larissa O'Donovan

Phone: 07 3840 0259
Email: Larissa.odonovan@au.lactalis.com

Reports may also be posted to PO Box 3012 South Brisbane Qld 4101 marked "Private and Confidential, to be opened by addressee only", and to the attention of one of the Protected Disclosure Officers.

While it is preferred that reports are made to a Protected Disclosure Officer, reports may also be made to:

- a. A member of the Lactalis Australia Executive team; or
- b. An internal or external auditor of Lactalis Australia.

You may also make a report to:

- a. ASIC;
- b. APRA; or
- c. A lawyer.

6. What happens once a call is made?

All reports of Reportable Conduct will be the subject of a thorough investigation and be undertaken as soon as practicable after receipt of the report. All investigations will be undertaken in a fair and impartial manner.

The investigative process will be determined by the nature and substance of the report. These processes may involve interviewing witness and individuals under investigation. Throughout the investigative process, appropriate steps will be taken to maintain the confidentiality of the investigation. Any person against whom report is made will be given the opportunity to respond.

If necessary, external experts may be asked to assist or conduct the investigation in accordance with this policy.

Where possible, you will be updated on the report's progress. Where a report is made anonymously, Lactalis will conduct the investigation based on the information received in the report.

7. Whistleblower protection

- a. Detrimental conduct

If you make a report, you are entitled to protection from detrimental conduct.

Detrimental conduct includes (but is not limited to) dismissal, discrimination, harassment, damage to a person's property disciplinary action, demotion, threats and other negative treatment or behaviour in connection with making a report.

If you believe you have been subjected to detrimental conduct in connection with a report, you should immediately report the alleged detrimental conduct to a Lactalis Protected Disclosure Officer, an officer or senior manager or in accordance with paragraph 4 of this policy.

b. Identity

When making a report under this policy, you are not required to disclose your name or other identifying information. If you choose not to disclose this information you are still covered by the protections and obligations under the *Corporations Act*. As well, you are able to refuse to answer questions you feel could reveal your identity at any time, including during follow-up conversations or communications

When making a report, you are entitled to have your identity (and information that may lead to your identification) kept confidential. If you make a report, it is illegal for a person to identify you or disclose information that is likely to lead to your identification. The exceptions to this are:

- i. Where you consent;
- ii. Where information is disclosed to a lawyer, for the purposes of obtaining legal advice; or
- iii. To ASIC, APRA or a member of the Australian Federal Police.

Information may be disclosed with or without your consent where the information does not disclose your identity, all reasonable steps have been taken to ensure you will not be identified from the information and the disclosure of the information is necessary for investigating the issues raised in your report.

c. Civil, Criminal and Administrative liability protection

You are protected from:

- i. Civil liability (actions against you for breach of your contract of employment);
- ii. Criminal liability (prosecution in relation to the disclosure you have made); and
- iii. Administrative liability (disciplinary action in relation to the disclosure you have made).

These protections do not apply where you have engaged in misconduct which is revealed as part of your report.

However the protections do apply to both reports made internally and reports made to external parties including ASIC, APRA and a lawyer.

Except for proven misconduct, no contractual or other remedy may be taken or enforced against you, and no contractual or other right may be exercised against you due to your report.

8. Malicious Reporting or Breach of confidentiality

Any malicious reporting is a serious matter which will render the person concerned subject to Lactalis' relevant disciplinary proceedings.

9. Breach of Policy

A breach of this policy may render a person subject to civil or criminal action.

A breach of this policy will also be considered misconduct and may expose a person to disciplinary action including possible termination of employment.

ANNEXURE B – ANIMAL WELFARE POLICY



CARING FOR ANIMALS ALL ALONG OUR VALUE CHAIN

Lactalis Group Animal Welfare Policy

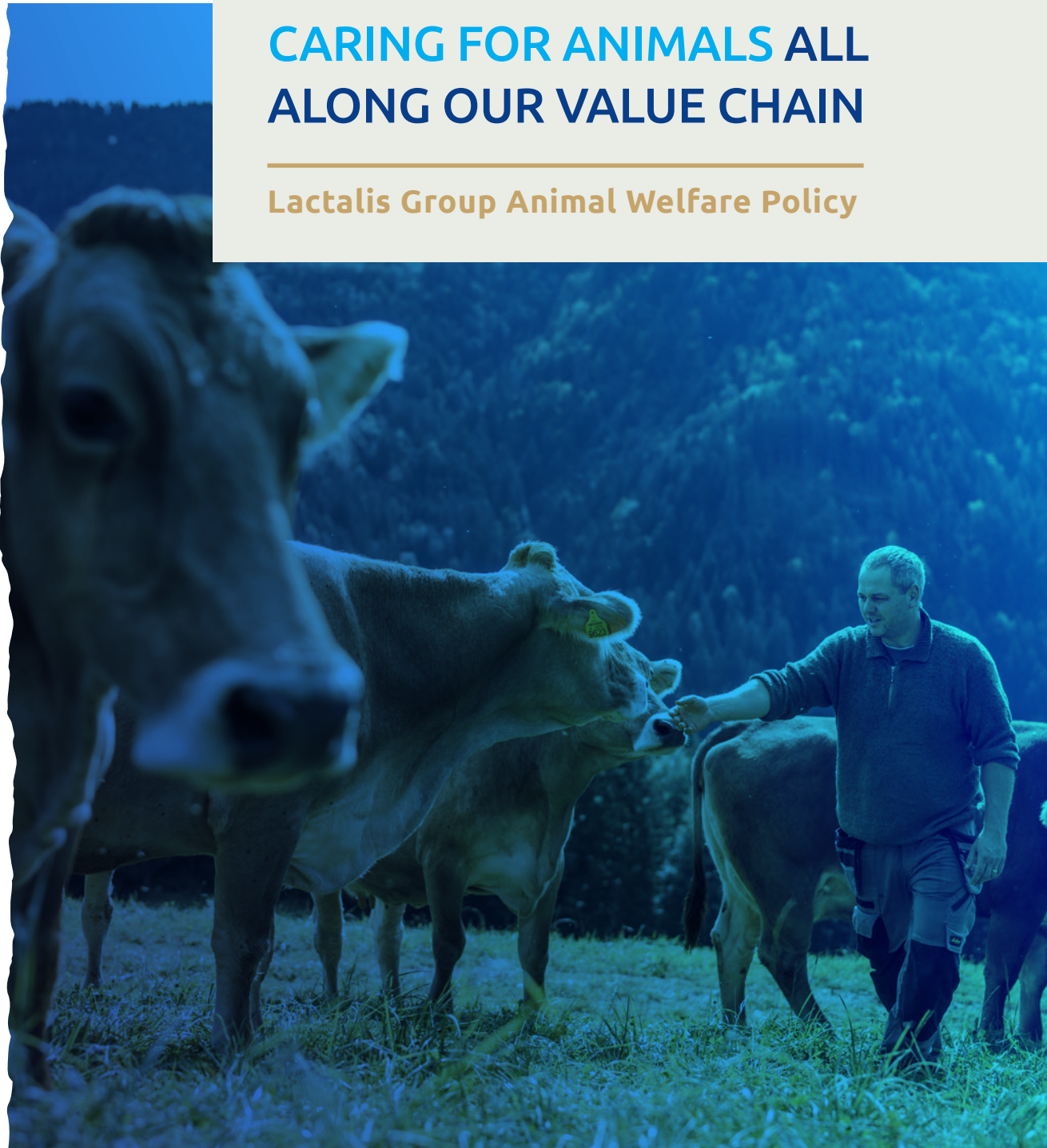



The Lactalis Group Animal Welfare Policy is comprised of four sections: our vision, our guiding principles, our approach & ambitions (3 sub-sections) and our governance. We aim to apply this policy to all the animals in our supply chain worldwide, regardless of the related finished product (cf. Annex 1: Our global scope).

At this stage, the section "03. Our approach & ambitions" is applicable to raw milk (dairy cows and calves), dairy ingredients (dairy cows and calves) and shell eggs and egg products (laying hens) that we use in some of our recipes like dairy desserts.

01

OUR VISION

01. OUR VISION

At Lactalis, contributing to animal welfare is not only our responsibility, but also a cornerstone for the sustainability of the company's activities.

As the world's leading dairy group and the third largest global milk collector, we pay special attention to all the animals in our supply chain, in particular to the approximately 5 million dairy animals (cows, buffalos, sheep and goats). We fully recognise and respect them as sentient beings, capable of feeling emotions, that deserve both physical and mental health: contributing to their wellbeing is our responsibility.

Moreover, animal welfare is a cornerstone for the sustainability of our activities. Indeed, as all our partnering farms know, there is a close link between animal welfare and production. For example, a cow needs sufficient access to food and water, sufficient bedding space, good hygiene and much more in order to produce high quality milk. Therefore, ensuring animal welfare is already part of our daily work as well as our partnering farms.

However, as scientific knowledge improves and our stakeholders' expectations grow, we recognise that we must go further and support transparent communication.

Our vision: we strive to advance our approach on animal welfare to ensure that animals have a good life, help to improve the performance of our partnering farms, meet the expectations of our stakeholders and preserve the sustainability of our supply chain.

02. OUR GUIDING PRINCIPLES

02

OUR GUIDING PRINCIPLES

Being established in more than 50 countries around the world (including 49 where we collect raw milk), our priority is to ensure that our approach (*cf. 03. Our approach & ambitions*) is both internationally credible and locally relevant.

For this purpose, we have defined four guiding principles:

1. ALIGNING OUR APPROACH WITH THE INTERNATIONALLY RECOGNISED “FIVE FREEDOMS”

According to the World Organisation for Animal Health (OIE), “developed in 1965, and widely recognised, the Five Freedoms describe society’s expectations for the conditions animals should experience when under human control, namely:

- Freedom from hunger, malnutrition and thirst
- Freedom from fear and distress
- Freedom from heat stress or physical discomfort
- Freedom from pain, injury and disease
- Freedom to express normal patterns of behaviour”

At Lactalis, we support this definition and aim for our approach to ensure the compliance with and the preservation of the “Five Freedoms” for all animals in our supply chain (*cf. Annex 1: Our global scope*).

2. USING THE WELFARE QUALITY ASSESSMENT PROTOCOLS AS OUR MAIN FRAMEWORK

Favouring a science-based approach, we rely heavily on the existing Welfare Quality Assessment Protocols¹ as well as the widely respected expertise of the Welfare Quality Network.

The Welfare Quality Assessment Protocols describe procedures for the assessment of animal welfare of various species (cattle, pig, poultry and laying hens). These protocols were developed in the context of the European Welfare Quality Project, in collaboration with a large number of research groups and institutes². A characteristic of the approach used in these protocols is that they focus on animal-based measures (e.g. directly related to animal body condition, health aspects, injuries, behaviour, etc.). At Lactalis, these protocols are the basis of our assessment methodology. In addition, we include criteria from other recognised protocols that focus on design and aspects of farm management (e.g. size of barns, flooring materials). This ensures optimal field implementation of our methodology in different production systems around the world.

The Welfare Quality Network is a collaborative effort of a large group of former partners of the Welfare Quality Project. Its activities involve, among others, upgrading the protocols, prioritising and facilitating research and working on specific farm animal welfare issues. Since 2021, Lactalis is an associate partner of the Welfare Quality Network.

(1) As our approach (*cf. 03. Our approach & ambitions*) focuses on dairy cows and calves at this stage, only the Welfare Quality Assessment Protocol for cattle has been used

(2) For more information on the Welfare Quality Project, refer to the website of the Welfare Quality Network



3. TAKING INTO ACCOUNT LOCAL SPECIFICITIES

In defining our approach at Group level, we pay particular attention to national and local specificities, both in terms of methods and ambitions.

For example, many of the countries in which Lactalis collects milk have already implemented national charters or projects to improve the animal welfare of dairy cows and calves (e.g. Red Tractor Assurance scheme in the United Kingdom, ClassyFarm system in Italy, Charte des Bonnes Pratiques d'Élevage in France, FARM program in the United States, Certificado "Welfare" in Spain, etc.). These charters and projects have been defined to meet national stakeholders' expectations; they are locally relevant and we intend to build on them as much as possible.

Moreover, the many countries where we are established have different levels of maturity and a huge diversity of farming systems. The Group's approach described below must be considered as a minimum. Country by country, our local teams are encouraged to go above and beyond when possible.

4. INVOLVING OUR INTERNATIONAL AND LOCAL STAKEHOLDERS

Although Welfare Quality Assessment Protocols are widely recognised in Europe, there is no international standard for animal welfare. Moreover, scientific knowledge and societal expectations are making progress every day. Therefore, in order to stay aligned with these evolutions, we are committed to working closer with our stakeholders, both at international and national level, to develop and regularly update our approach and ambitions on animal welfare (*cf. Annex 2: Our partners*).



03. OUR APPROACH & AMBITIONS

Our “animal welfare” approach and ambitions are defined for each type of animal-based product.

RAW MILK (DAIRY COWS AND CALVES)

Five main commitments concern raw milk from dairy cows; they all, with the exception of commitment N°2, apply to all dairy cows and calves related to raw milk collected by Lactalis worldwide:

1. Ensuring that all our partnering farms are not responsible of any acts of animal cruelty and comply with local and international regulations

At Lactalis, we have zero tolerance regarding animal cruelty and illegal practices. In order to strengthen our internal management of animal mistreatment cases, we have identified two opportunities for improvement:

- First, we will ensure that all Lactalis staff in contact with our partnering farms are trained on animal cruelty avoidance and are aware of all illegal national and international practices.
- Then, we will establish an internal procedure to clearly address situations where a Lactalis partnering farm is identified (by an internal or an external party) as having engaged in animal cruelty and/or illegal practices. This procedure will outline the respective corrective actions to be deployed depending on the situation.



2. Enrolling our direct³ partnering farms (and indirect ones where possible) in a process of continuous improvement, phasing out the most problematic practices and implementing the best ones

This process will be mainly based on:

- Raising awareness and training actions for both partnering farms and Lactalis dairy technicians. Indeed, we are deeply convinced that our dairy technicians, whose daily work includes providing technical support to partnering farms, have a key role to play when it comes to animal welfare. For example, many of the practices that lead to better animal welfare are also profitable for farmers; dairy technicians should be aware of them and contribute to their implementation.
- A *Lactalis Animal Welfare Assessment Program* to identify the areas of improvement of each farm and to recommend the most relevant improvements actions. This Program will be defined by the end of 2022 in collaboration with recognised third parties such as universities and non-governmental organisations. As a minimum, it will include on-farm assessments at a frequency of once every 3 years, based on measurable criteria assessing the respect of the "Five Freedoms". Once this Program is established, we intend to have it externally verified.

As needs evolve, both the training actions and the Assessment Program are subject to regular review to ensure alignment with stakeholders' expectations and scientific findings.



OUR AMBITIONS:

As a first step, we will initially focus our efforts on our direct volumes⁴ in 8 Pilot Countries (representing around 50% of our total raw milk collection worldwide, *cf. Annex 1: Our global scope*) and on 10 animal welfare topics.

Specifically, within these 8 Pilot countries, we will:

- Train 100% of our dairy technicians by 2023
- Assess 100% of our direct volumes by 2025
- Prioritise work on the following sensitive topics: tethering, bedding space, calves in groups, access to pasture, effective species-specific environmental enrichment, growth hormones, antibiotics, disbudding / dehorning, tail docking and animal derived proteins in feed

The 8 Pilot Countries involved as well as our detailed commitments are described in Annex 3.

(3) A farm supplying raw milk to Lactalis is considered as "direct" if a) There is an individual contract between Lactalis and the Farm Manager and/or b) Lactalis can propose to the Farm Manager, individually, a plan to improve his farming practices without having obtained a prior formal agreement of any third party (e.g. a cooperative). Otherwise, the farm is considered as "indirect".

(4) A volume of collected raw milk is considered as "direct" when coming from a "direct" farm (*cf. footnote 3.*)

3. Advocating for the implementation, deployment and reinforcement of ambitious national Animal Welfare standards

While defining and implementing our own *Lactalis Animal Welfare Assessment Program* (cf. *Commitment N°2 above*), we are engaged to contributing to the development of ambitious national Animal Welfare standards and regulations.

Our objectives are as follows:

- Concerning our direct partnering farms, we aim to collaborate with governments, international organisations, industry and other stakeholders to work collectively on some animal welfare issues that we may not be able to address alone. For example, replacing a tethering system with a loose housing system requires major investments and significant changes for farmers. We are committed to work on this at our level (cf. *Annex 3: Raw milk (dairy cows and calves) - Our specific commitments for our direct volumes in 8 Pilot Countries*) but we are convinced that a collective dynamic is also necessary.
- Concerning our indirect partnering farms where we do not have the possibility to implement the *Lactalis Animal Welfare Assessment Program*, our aim is that all of them are covered by ambitious national standards and/or regulations.

4. Collaborating with our stakeholders to improve scientific knowledge and develop innovations on animal welfare

As farm practices change and stakeholders' expectations grow, there is a need to improve scientific knowledge of animal welfare and develop new solutions that are adapted to different production systems.

That is why we are committed to supporting and participating in research and development projects to improve animal welfare. We are convinced that working hand in hand with external partners who bring technical and technological expertise is key to ensure the successful transfer of knowledge and scientific findings to the field.

5. Reporting publicly and annually on our actions and progress

We are committed to having transparent communication on the fulfilment of the 4 commitments described above.

Each year, we will publish a *Lactalis Animal Welfare Progress Report* that will be accessible to the general public. In it, we will remind our commitments, describe our actions, reflect our progress and if needed, describe corrective actions to be implemented.

DAIRY INGREDIENTS (DAIRY COWS AND CALVES)

Our “animal welfare” approach on dairy ingredients other than raw milk (e.g. milk powder) is part of our Responsible Sourcing policy.

In the context of this policy, all Lactalis’ suppliers, including those supplying dairy ingredients, must commit to compliance with the rules defined in the *Lactalis Ingredients and Dairy Materials Charter*. Particularly with regard to animal welfare, this Charter involves:

- Providing to Lactalis Group products fully compliant with the legislation in force in the country.
 - If appropriate, implementing plans to enhance and promote animal welfare.
- In addition, all Lactalis suppliers must agree to the presence of our auditors for the carrying out of approval, evaluation or monitoring audits.

SHELL EGGS⁵ AND EGG PRODUCTS⁶ (LAYING HENS)

Like for dairy ingredients, our “animal welfare” approach on shell eggs and egg products is part of our Responsible Sourcing policy.

In this context, we are committed to laying hens’ welfare and to the promotion of transparency across our supply chain. More precisely, we have engaged in dialogue with specialised non-governmental organisations and our suppliers to play our part in the cage-free transition of the global egg market. And from the very beginning we have decided to tackle not only our procurement of shell eggs but also our purchase of egg products used as ingredients.

Moreover, we are committed to reporting publicly and annually on our actions and progress in this transition to cage-free shell eggs and egg products supply; it will be part of the *Lactalis Animal Welfare Progress Report* mentioned above.



OUR AMBITIONS:

- In the European Union, we have committed to, and achieved at End 2021, phasing out the purchase of shell eggs and egg products originating from caged systems (also known as “Code 3”).
- At global level, we will stop purchasing and using shell eggs and egg products from caged systems (also known as “Code 3”) by the end of 2025.

(5) Whole raw eggs with the shell unbroken

10 (6) Processed and convenience forms of eggs, including liquid, frozen, dried and pre-cooked products

04. OUR GOVERNANCE

Our governance is organised in 3 main levels:

04

OUR GOVERNANCE

- The Board of Directors of Lactalis Group is responsible for the successful implementation of the *Lactalis Animal Welfare Policy*.
- An Animal Welfare Committee is in charge of proposing the policy (and its revision when relevant) to the Board of Directors, monitoring the actions and the results and steering common actions. It is composed of Lactalis internal Corporate experts from the most relevant departments (Milk Supply, CSR and Purchasing). Its work implies regular interactions with a network of Lactalis internal experts based in our active countries (especially from the Country Milk Supply Departments described below).
- The Country Milk Supply Departments are in charge of implementing actions and reporting (actions and results) to the Animal Welfare Committee. Each Country Milk Supply Department is composed of a Milk Supply Director and may include Milk Supply CSR Managers and dairy technicians.



ANNEXES

ANNEX 1: OUR GLOBAL SCOPE (PER ANIMAL-BASED PRODUCT)

Raw milk

	Volumes of raw milk collected by Lactalis, 2021 (billion litres)	Estimated number of partnering farms* (thousand)	Estimated number of dairy animals* (million)
Worldwide: 49 countries			
Cows and buffalos	21.6	453.0	3.9
Sheep	0.2	3.2	1.1
Goats	0.1	1.4	0.3
TOTAL	22.0	457.6	5.2
Whom: our direct volumes in 8 Pilot countries			
Cows	9.8	20.6	1.4
% of TOTAL	45%	4%	26%

*Number of partnering farms and number of dairy animals have been estimated, country by country, on the basis of "Volumes of raw milk collected by Lactalis, 2021" and:

- For the 8 Pilot Countries (Australia, Belgium, Brazil, France, Italy, Spain, United Kingdom and United States of America): data collected in 2021 on representative samples of Lactalis' partnering farms (one representative sample per country).
- For the other countries: average 2020 data from IFCN⁷.

Dairy ingredients

At Lactalis, we use dairy ingredients (e.g. milk powder) in several of our recipes.

Shell eggs and egg products

At Lactalis, we use shell eggs and egg products in several of our recipes, especially in dairy desserts.

(7) Hemme (ed.) 2021: IFCN Dairy Report 2021, IFCN, Kiel, Germany.

ANNEX 2: OUR PARTNERS

Wageningen University & Research

Wageningen University & Research, renowned for its food and food production research, is an independent research and advisory partner.

During year 2021, we collaborated with experts from Wageningen University & Research to define the *Lactalis Farm Sampling Methodology*. This methodology allows us to determine representative samples of Lactalis' partnering farms in various countries. We used it to select around 700 farms where we conducted the first *Lactalis On-farm assessments* addressing sustainability topics (such as animal welfare). At this stage, our objective was to better know our performance without carrying out assessments in all our partnering farms (more than 450,000); which was not feasible in one year. The results from these representative on-farm assessments will be reported by the end of 2022, in our first *Lactalis Animal Welfare Progress Report* (cf. 03. *Our approach & ambitions, Raw milk (dairy cows and calves), commitment N°5*).

During year 2022, Lactalis will continue its collaboration with Wageningen University & Research in the context of the definition of the *Lactalis Animal Welfare Assessment Program* (cf. 03. *Our approach & ambitions, Raw milk (dairy cows and calves), commitment N°2*).

Welfare Quality Network

Since 2021, Lactalis is an associate partner of the Welfare Quality Network.

The Welfare Quality Network is a collaborative effort of a large group of former partners of the Welfare Quality Project. Its activities involve, among others, upgrading the protocols, prioritising and facilitating research and working on specific farm animal welfare issues.

ANNEX 3: RAW MILK (DAIRY COWS AND CALVES) OUR SPECIFIC COMMITMENTS FOR OUR DIRECT VOLUMES IN 8 PILOT COUNTRIES

The following specific commitments are part of our overall commitment N°2 for raw milk (dairy cows and calves), namely “Enrolling our direct partnering farms (and indirect ones where possible) in a process of continuous improvement, phasing out the most problematic practices and implementing the best ones”.

They apply to all dairy cows and/or calves related to the direct volumes of raw milk collected by Lactalis in 8 Pilot countries: Australia, Belgium, Brazil (Lactalis Do Brazil branch), France, Italy, Spain, United Kingdom and United States of America (Lactalis American Group and Stonyfield branches). These direct volumes represent 45% of total annual volume of raw milk collected by Lactalis (around 9.8 billion litres, 1.35 million of cows, 0.88 million of calves)⁸.

Our commitments and positions		Scope (among the 8 Pilot countries)
Transverse		
Lactalis on-farm assessments	<p>100% of our direct volumes will have on-farm assessments on animal welfare by 2025*</p> <ul style="list-style-type: none"> - With a once every 3 years frequency - In the context of a Lactalis Animal Welfare Assessment Program that will be defined by the end of 2022 in collaboration with recognised third parties such as universities and non-governmental organisations <p>*2026 in Brazil</p>	All
Technician trainings	<p>100% of our dairy technicians will be trained on animal welfare by 2023</p> <ul style="list-style-type: none"> - With a once every 3 years frequency - Including with external recognised trainings 	All
Per practice		
<i>Close confinement and intensive systems for livestock</i>		
Tethering	<p>Lactalis encourages loose housing systems and is committed to raising farmers' awareness not to build new tethering barns.</p>	All
Bedding space	<p>Farms supplying milk to Lactalis should provide cows with satisfying bedding space</p> <ul style="list-style-type: none"> - In loose housing system with loafing area integrated: at least 10 m² per large-sized* cow or at least 7.5 m² per small-sized* cow - In loose housing system with distinct loafing area: at least 7 m² per large-sized* cow or at least 5.5 m² per small-sized* cow - In free-stall system: at least 1 stall per cow <p>*Large-sized cow: average live weight of lactating cows ≥ 600 kg Small-sized cow: average live weight of lactating cows < 600 kg</p>	All

(8) 2020 figures

<i>Close confinement and intensive systems for livestock (to be continued)</i>		
Calves in groups	Lactalis promotes group housing for calves from 4 weeks of age	All
	In European Union Countries*, the UK*, Australia and Brazil, all dairy calves within Lactalis supply chain must be reared in groups from at least 8 weeks of age <i>*According to local regulations</i>	European Union Countries, UK, Australia, Brazil
<i>Effective species-specific environmental enrichment</i>		
Access to pasture	Lactalis endorses pasture grazing for dairy cows wherever appropriate	All
Effective species-specific environmental enrichment	Lactalis encourages partnering farms to implement enrichment tools to give animals the opportunity to express their natural behaviours	All
<i>Growth promoting substances</i>		
Growth hormones	In European Union Countries*, the UK*, Australia and the USA, growth hormones are not permitted within Lactalis supply chain <i>*According to local regulations</i>	European Union Countries, UK, Australia, USA
	In Brazil, Lactalis is committed to eliminate growth hormones (rBST) by 2030	Brazil
<i>Antibiotics for prophylactic use</i>		
Antibiotics	Lactalis aims to fight against antimicrobial resistance and supports partnering farms to reduce prophylactic use of antibiotics	All
	In European Union Countries, according to local regulations, prophylactic use of antibiotics will be prohibited from 2022 (except in certain exceptional cases as described in the regulations)	European Union Countries
<i>Routine mutilations</i>		
Disbudding / dehorning	Lactalis promotes recognised best practices for disbudding and will eliminate routine dehorning by 2025* <i>*2026 for the last farms who will be assessed in 2025 (cf. Lactalis on-farm assessments above)</i>	All
Tail docking	Practicing routine tail docking is not permitted within Lactalis supply chain	All
<i>Other</i>		
Animal derived proteins in feed	All Lactalis partnering farms must be in compliance with national regulations regarding the use of animal derived proteins in dairy animal feed. In European Union Countries and Australia, according to local regulations, this practice is strictly forbidden for ruminants	All



Lactalis Group

Head offices – 10 rue Adolphe Beck – 53000 LAVAL – FRANCE
A French limited company (*Société Anonyme à Directoire et Conseil de Surveillance*)
with share capital of € 140,027,040
SIREN 331 142 554 – RCS LAVAL

 [company/lactalis/](https://www.linkedin.com/company/lactalis/)  [@groupe_lactalis](https://twitter.com/groupe_lactalis)

www.lactalis.com

The targets, associated timelines and scopes mentioned in this document reflect current assumptions. Acquisitions, regulatory changes or other factors may have a major impact on these assumptions. In such cases, Lactalis Group reserves the possibility to review and adjust them accordingly.

The version of this document available on the Lactalis Group website shall prevail.

SCHEDULE F – PRIVACY POLICY



Lactalis Australia Pty Ltd
Privacy Policy

1. About this Policy

Lactalis Australia Pty Ltd (ABN 56 072 928 879) and its wholly owned subsidiaries ('we', 'us', 'our') understands the importance of, and is committed to, protecting your personal information. We are bound by the *Privacy Act 1988* (Privacy Act) and must protect your personal information according to the Act and other applicable laws such as Spam Act 2007 (Privacy Laws).

Please refer to our Credit Reporting Policy on our website for information on how we manage our credit information.

Purpose

The purpose of this Policy is to explain how we can collect, use, hold and disclose your personal information by:

- giving you a better and more complete understanding of the sort of personal information that Lactalis holds, and the way we handle that information; and
- clearly communicating to you how we deal with personal information

2. GDPR Compliance – for our Customers and Suppliers in the European Union

From 25 May 2018, the General Data Protection Regulation (GDPR) regulates the processing of personal information under European Union (EU) law. The GDPR aims to protect the information relating to individuals in the EU and harmonise data protection laws across EU Member States. Our collection, use, disclosure and processing of your personal information is regulated by the GDPR if we offer or receive products or services to/ from you whilst you are located in the EU.

3. What is personal information

Personal information includes any information or opinion, about an identified individual, or individuals who can be reasonably identified from that information. The information or opinion will still be personal information whether it is true or not and regardless of whether we have kept a record of it.

Some examples of personal information may include your:

- name;
- mailing or residential address details;
- contact details such as telephone numbers, email address, social media platform user name;
- government issued identifiers such as tax file numbers, Medicare number, driver license number;
- bank account and credit card details;
- credit history and credit worthiness;
- employment history;
- photographs, video or audio recording; and
- sensitive information such as information relating to your health, biometric data, criminal history, racial or ethnic origin.

4. Information we collect about you

We only collect information about you that we reasonably need for our business functions and activities. Our functions and activities include:

- manufacturing and supplying dairy products and associated services;

- activities in support of those functions including administration, management, marketing, online and mobile marketing, IT, legal, security, customer support (including the Consumer Information Centre), finance (including credit control), property management and human resources; and
- activities we plan for the future including new ways of communicating, new products and services, new business models and new businesses.

Generally we may collect the following personal information about you:

- your name;
- your contact details including residential or business address, telephone number and email address;
- your employment history (where relevant for recruitment purposes); and
- sensitive health information, including your vaccination status (if Lactalis is required or authorised to collect by law),

and where you or your business submit a credit application:

- certain other types of personal information (including information contained in a consumer or commercial credit report about you) including:
 - information about your credit history, including information about your past experiences with us and other credit providers;
 - the kinds of credit products that you have sought and obtained in the past;
 - information about your consumer credit payments overdue for at least 60 days and for which collection action has started;
 - advice that payments that were previously notified to a CRB as overdue are no longer overdue;
 - publicly available information about your credit worthiness; and/or
 - an opinion of a credit provider that you have committed a serious credit infringement in relation to credit provided by that credit provider.
- we may also derive information about you from consumer or commercial credit reports about you, including:
 - information which assists us to assess your suitability for credit; and/or
 - the likelihood of you being able to meet your commitments to us.

We may combine the personal information described above with other information about you, for example:

- if your business or employer supplies us with products or services, or if your business or employer distributes or sells our products and services, we collect information about your trading with us (for example the products you buy or sell and credit card records), your trading history and account history;
- if you apply for a position with us, we collect information to help us decide your application, which may include your date of birth, tax-file number, work history and similar details;
- if you request information from us (for example about a competition) or register a complaint, we collect information about your request or complaint; and/or
- if you buy products and services, we may collect information about your purchasing preferences and history.

We record this information (personal information) in our database whilst we deal with you. We will remove this information from our database when we have no further need to keep a record of it, except if we are required to keep it by law (for example, for tax or for superannuation purposes).

5. How we collect information about you

How do we collect personal information?

Usually we collect personal information directly from you, whether in person, on the phone or electronically. For example, we may record your contact details when you call our call centre, when you fill out an application form (including a credit application), when you enter one of our competitions or promotions, or when you ask us to do something for you.

From time to time we may collect personal information about you from third parties or organisation. This may arise where you have given your consent to do so or where we notify you that we are collecting information in the application. For example:

- we may engage a consultant or agent to collect information for us about people who may be interested in buying or selling our products and services, or about people from whom we may be interested in buying or selling products and services;
- if you are an employee of one of our business partners (e.g. a supplier or distributor), we may be given your name and contact details by your employer;
- if you enter a competition or promotion organised by us, we may be given your name and contact details by the agent or promoter organising the event;
- if you make a credit application and also where you carry on business with us on credit terms, we may obtain information about you from credit reporting bodies and other credit providers;
- our service providers may provide us with your personal information from websites, social media sites, mobile, and other technology based sources; and/or
- we also may collect information about you from publicly available sources, such as public registers.

We use lawful and fair means to collect your information. We will collect personal information about you from another person or from a publicly available source only if it is unreasonable or impracticable to collect it directly from you, and we will take reasonable steps to inform you that we have collected your personal information. Those reasonable steps may include informing you through this statement.

Unsolicited information

If we receive personal information about you that we have not requested, and if we determine that we could not have lawfully collected that information under privacy law if we had requested it, we will destroy or de-identify the information, if it is lawful and reasonable to do so.

6. Do I have to provide you with my personal information?

You can choose to deal with us anonymously (without giving us your name and contact details) or by using a pseudonym (a name that does not include your real name, for example an email address or a user name that you use in an online forum (nickname)).

If you choose to deal with us anonymously or using a nickname, we can give you general information about our products and services, you may be able to buy certain products and services from us, and you may be able to participate in any online forum we provide, but there are some things we may not be able to do, for example:

- if you do not give us your personal information we cannot give you information about or open or close an account (if you are a supplier or distributor), may not be able to deal with a complaint you may have or deliver a product to you at an address. You cannot enter into one of our competitions or promotions anonymously or using a nickname; and
- if you do not give us your personal information we cannot assess your suitability for a role with Lactalis Australia.

You can deal with us using a nickname together with your real name and contact details. If you choose to deal with us in this way, we may collect your personal information together with your nickname. When you identify yourself to us using your nickname only, we can deal with you only as set out above. We may ask you to provide proof of your identity if you use a nickname.

7. Why we collect personal information about you (purpose of collection)

The main reasons we collect, use, hold and disclose personal information is to help run our business. This includes:

- administration of our business dealings with you;
- assessment and processing of credit applications made by you or your business, establish, provide and administer your credit account, and collect overdue payments development of insights and analysis to improve in the delivery of products and services;
- administration of any competitions or marketing activities that we undertake; and
- for compliance with legislation and regulations (including public health orders) such as Safe Food Queensland.

We may also collect, use, hold and disclose your personal information for the purpose of considering you for a potential employment opportunity with Lactalis Australia.

We also collect your personal information for certain secondary purposes that are related to the primary purposes outlined above (or directly related where sensitive information is concerned). Secondary purposes may include so that we can run our business efficiently, for example, our advisors can provide us with customer research, or so that we can use technology to automate our business and to understand how our business is performing, to allow us to operate efficiently and to lower costs by outsourcing services (such as collecting or paying money). Other secondary purposes may include so that we can sell or transfer our business or merge with another business.

8. Disclosure

Who do we disclose your personal information to?

We may share your personal information with our subsidiary companies.

We do not use or disclose your personal information for a purpose other than:

- a purpose set out in this privacy policy (primary or secondary purpose above);
- a purpose you would reasonably expect;
- a purpose required or permitted by law; and/or
- a purpose otherwise disclosed to you to which you have consented.

Depending on the circumstances, we may disclose your personal information to other people or organisations outside of Lactalis Australia including:

- service providers, including management, IT, security, legal, accounting, research, credit, marketing, insurers, financial institutions, debt collection agencies and others;
- other credit providers, to assist them with assessing a credit application they have with you, or to ensure that the information about you that we handle is correct;
- credit reporting bodies in order to obtain credit reports and also for the purpose of dealing with defaults on your credit account and serious credit infringements;
- our related companies, and companies that we may merge with or who may acquire ownership of us;
- government, regulatory and law enforcement authorities, where we are required to or permitted to by law; and/or
- your employer, if you are an employee of a supplier or distributor.

We take reasonable steps to ensure that these organisations are bound by confidentiality and privacy obligations with respect to the protection of your personal information.

Disclosure overseas

Lactalis Australia is part of the Lactalis Group, a French family owned business, and consequently we may disclose your personal information to our parent companies in France or Italy.

We also may disclose your personal information to an overseas service provider, for example a cloud data centre or a customer information call centre.

If it is not practicable or reasonable for us to gain your consent to disclose your personal information to an overseas service provider, we will take reasonable steps to notify you of the specific countries where we disclose your personal information.

When we do disclose and / or store personal information overseas, we will take reasonable steps to ensure that the overseas services provider protects that information by complying with security measures and is bound by privacy and confidentiality obligations to us.

9. Access to your personal information

You may request access to the personal information that we hold about you by using the contact details provided below.

We will deal with your request for such access within a reasonable time. If we refuse access, we will provide you with a written notice which sets out the reasons for the refusal and the relevant provisions of the Privacy Act that we rely on to refuse access.

We may recover reasonable costs in relation to a request for access to personal information.

Accuracy and correction

We take reasonable steps to make sure that the personal information we collect is accurate, up-to-date and complete. We take reasonable steps to make sure that the personal information we use or disclose is accurate, up-to-date, complete and relevant. Where we believe that the personal information we hold is inaccurate, out-of-date, incomplete, irrelevant or misleading, we will take reasonable steps to correct that information.

You may request that we correct your personal information that we hold by contacting us by using the contact details provided above. We will take reasonable steps to correct the information to ensure that it is accurate, up-to-date, complete, relevant and not misleading.

We will deal with your request to correct your personal information within a reasonable time. If we do not agree with the corrections you have requested, we are not obliged to alter your personal information accordingly. However, where we refuse to correct any personal information as requested by you, we will give you a written notice which sets out the reasons for our refusal.

10. Security

We hold your personal information in paper-based and electronic files. We will take reasonable steps to ensure that your personal information which is kept in our files is protected from:

- misuse, interference and loss; and
- unauthorised access, modification or disclosure.

This means that, in respect of our paper-based files, we maintain various security systems on our premises, and in respect of electronic files, we (or our service providers) maintain secure electronic network systems.

When we no longer require your personal information (including when we are no longer required by law to keep records relating to you), we ensure that it is destroyed or de-identified.

Website

This section explains how we handle personal information collected from our websites (including social media site and mobile site if relevant). If you have any questions or concerns about transmitting your personal information via the internet, you may contact us using the contact details provided above, as there are other ways for you to provide us with your personal information.

Visiting our website

If you access an unsecured part of our websites, that is, a public page that does not require you to log on, we (or our service providers) will collect information about your visit, such as:

- the time and date of the visit;
- any information or documentation that you download;
- your browser type; and
- your server address

Cookies

A "cookie" is a small text file which is placed on your internet browser and which we access each time you visit our website. When you visit the secured pages of our website (ie pages that you have to provide login details to access) we use cookies for security and personalisation purposes. When you visit the unsecured pages of our website (ie public pages that you can access without providing login details) we use cookies to obtain information about how our website is being used.

You may change the settings on your browser to reject cookies, however doing so will prevent you from accessing the secured pages of our website.

Email

When we receive emails, we will retain the content of the email and our response to you where we consider it necessary to do so.

Your email address will only be used or disclosed for the purpose for which it was provided. It will not be added to any mailing lists or used for any other purpose without your consent.

Security

We make reasonable efforts to ensure that appropriate security measures are used on our website to protect your personal information. Any data containing personal information which we transmit via the internet is encrypted. However, we cannot guarantee that any information transmitted via the internet by us, or yourself, is entirely secure. You use our website at your own risk.

Links on our website

Our website may contain links to third party websites. We advise that the terms of this privacy policy do not apply to external websites. If you wish to find out how any third parties handle your personal information, you will need to obtain a copy of their privacy policy.

11. Marketing

We may use your personal information, including your contact details, to provide you with information about products and services, including those of third parties, which we consider may be of interest to you. But we will not do so if you tell us not to.

When we market products and services to you, we will comply with applicable Privacy Laws to obtain your consent if required.

We may also provide your details to other organisations for specific marketing purposes.

You may opt out at any time if you no longer wish to receive marketing information. In order to do so, you will need to request that we no longer send marketing materials to you or disclose your information to other organisations for marketing purposes. You can make this request by using the contact details provided above, or by "unsubscribing" from email marketing messages.

12. Notifiable Data Breaches

From February 2018, the Privacy Act includes a Notifiable Data Breaches (NDB) scheme which requires us to notify you and the Office of the Australian Information Commissioner (OAIC) of certain data breaches and recommend steps you can take to limit the impacts of a breach.

The NDB scheme requires us to notify about a data breach that is likely to result in serious harm to affected individuals. There are exceptions where notification is not required. For example where we have taken appropriate remedial action that removes the risk of any serious harm to individuals.

If we believe that there has been a data breach that impacts your personal information and creates a likely or serious harm, we will notify you and the OAIC as soon as practicable and keep you informed about the nature of the breach, the steps that we are taking and what you can do to reduce the impacts on your privacy.

If you believe that any of the personal information we hold has been impacted by a data breach, you can contact us, using the details below.

13. Resolving concerns and complaints

If you have any questions, concerns or complaints about this privacy policy, or about how your personal information is being handled by us or a contracted service provider please contact our Privacy Officer using the contact details provided below:

Privacy Officer: 1800 676 961

Email: Legal@au.lactalis.com.au

Once a complaint has been lodged, the Privacy Officer will acknowledge receipt of your complaint, and we will let you know if we need any further information from you to resolve your complaint.

We aim to resolve complaints as quickly as possible. We strive to resolve complaints within 10 business days but some complaints may take longer to resolve. If your complaint is taking longer, we will let you know what is happening and when you can expect a response.

Under the Privacy Act you may also lodge a complaint with the Office of the Australian Information Commissioner by telephone: 1300 363 992 or email: enquiries@oaic.gov.au.

Please note that the OAIC requires any complaint must first be made by respondent organisation. The law also allows 30 days for the respondent organisation to deal with a complaint before a person may make a complaint to the OAIC.

14. Changes to the Privacy Policy

We may change the way we handle personal information from time to time. If we do so, we will update this Privacy Policy. An up to date version of this policy is available at any time at lactalis.com.au.