



Parallel Operation of Lead Acid Batteries

Please Note: The information in this technical bulletin was developed for C&D Dynasty 12 Volt VRLA products. While much of the information herein is general, larger 2 Volt VRLA products are not within the intended scope.

The numbers of plates that are connected in parallel determine the capacity of a cell. For example, if one set of positive and negative plates is capable of providing 5 ampere hours capacity at the 8-hour rate, 10 sets of plates connected in parallel will provide 50 ampere hours capacity.

Just as plates can be connected in parallel to increase the capacity of a cell, completed cells and series connected strings of cells (ref. Figure 1) can be connected in parallel to increase the capacity of the battery system.

For example, two 48 volt strings rated at 50 ampere hours capacity can be connected in parallel as shown in Figure 2 to provide 48 volts at 100 ampere hours capacity.

Use of parallel strings can improve the reliability of a battery system in that should one of the individual strings fail, the balance of the parallel strings may be able to carry the critical load though for a shorter period.

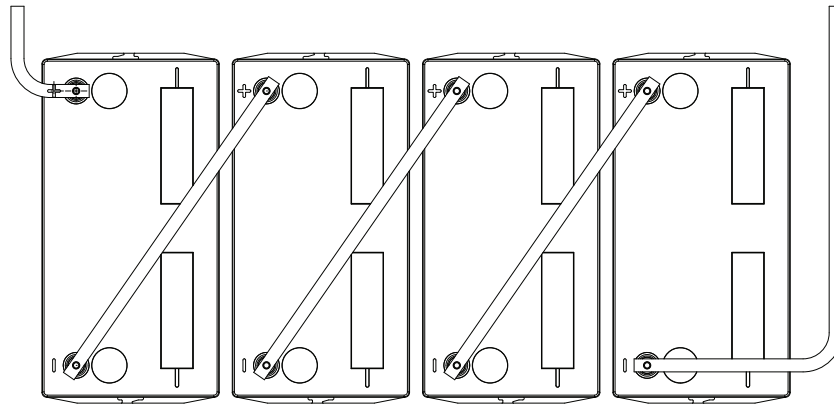

Figure 1 – Series Connected String

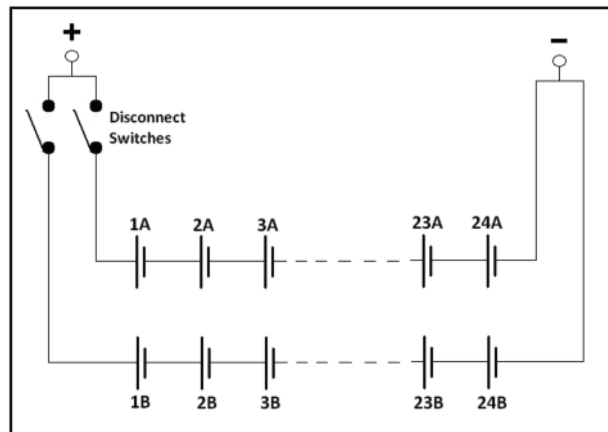

Figure 2 – Parallel Connected Strings

It is most practical that the individual parallel strings all be of the same capacity as this will aid in the avoidance of errors during installation and will make troubleshooting of the total system less complex. However, there is no technical reason that the individual parallel strings must all be of the same capacity. When battery strings of unequal capacity are connected in parallel each string will deliver power and accept recharge current proportional to its percentage of the total combined capacity as shown in Figure 3.

Note: In Figure 3 that the 33 Ah battery provides about 25% of the total load current while the 100 Ah battery provides 75%.

This is further confirmed in Figure 4 where it will be noted that the total Ah removed from each string of batteries is also proportional to the string Ah capacity relative to the total combined Ah capacity.

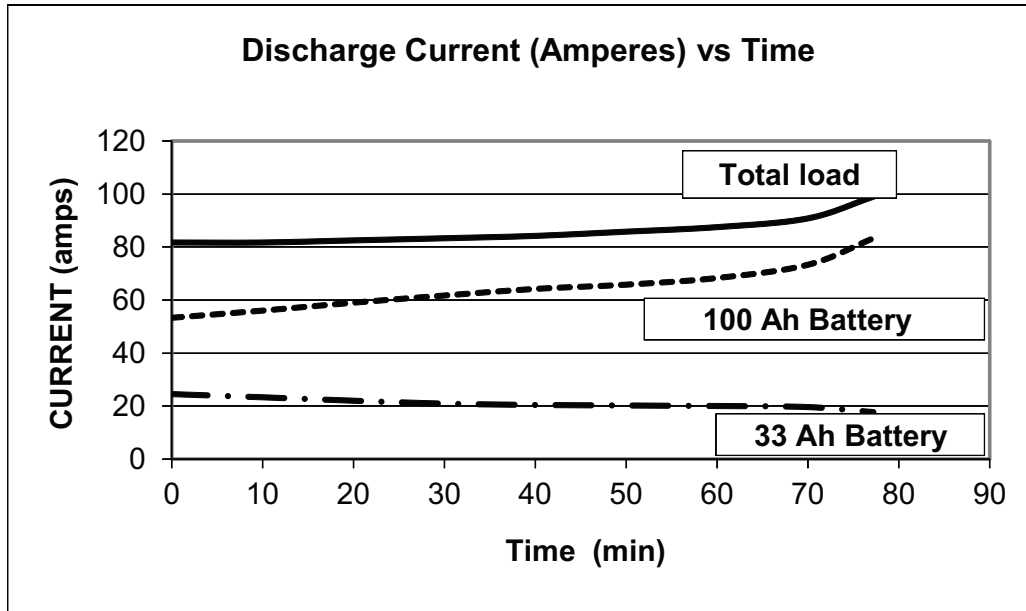

Figure 3 - Discharge of Parallel Strings

This is further confirmed in Figure 4 where it will be noted that the total Ah removed from each string of batteries is also proportional to the string Ah capacity relative to the total combined Ah capacity.

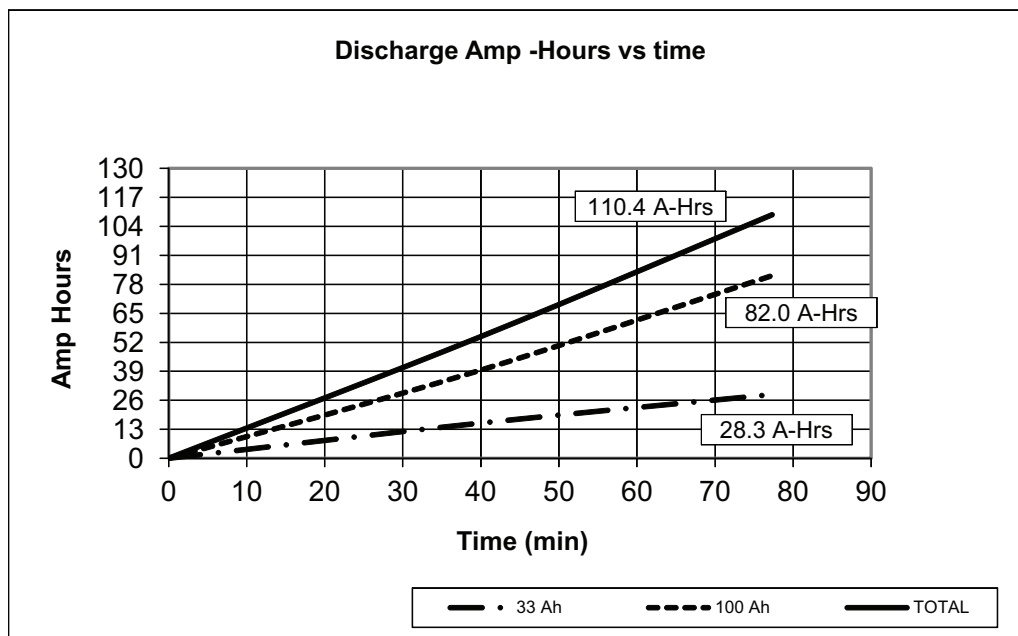

Figure 4 - Discharge Ah of Parallel Strings

Just as the total discharge current will be divided proportionally to the individual string's Ah capacity, so will the total recharge current be divided. This is shown in Figure 5 where it will be noted that the 33 Ah string is accepting 5 amperes (25% of the total) while the 100 Ah string is accepting 15 amperes or 75% of the total.

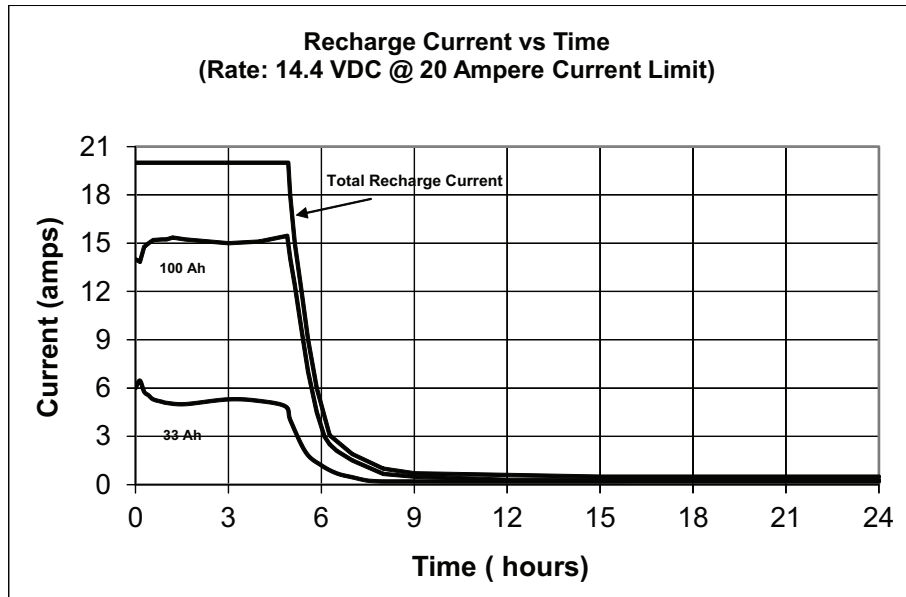

Figure 5 - Recharge of Parallel Strings

From a practical standpoint, the ratio of capacities of the individual strings should not exceed 1:5.

When designing a battery system utilizing parallel strings it is important that each of the strings include a separate disconnect device and individual string fault protection as noted in Figure 6. To assure each parallel string is discharged to an equal depth of discharge, it is important that the voltage drop occurring in the circuit from each of the battery parallel strings be equal. This implies that when the individual parallel strings are all of the same capacity, the output cabling from each string be of the same total length (pos. length + neg. length) and wire size.

There is no technical limit to the number of strings that can be connected in parallel. The limit of parallel strings is somewhat subjective and a function of the additional cost and complexity associated with cabling the individual strings through disconnects to the common tie point; additional interunit connections to be installed and maintained; individual unit monitoring and maintenance and battery system troubleshooting.

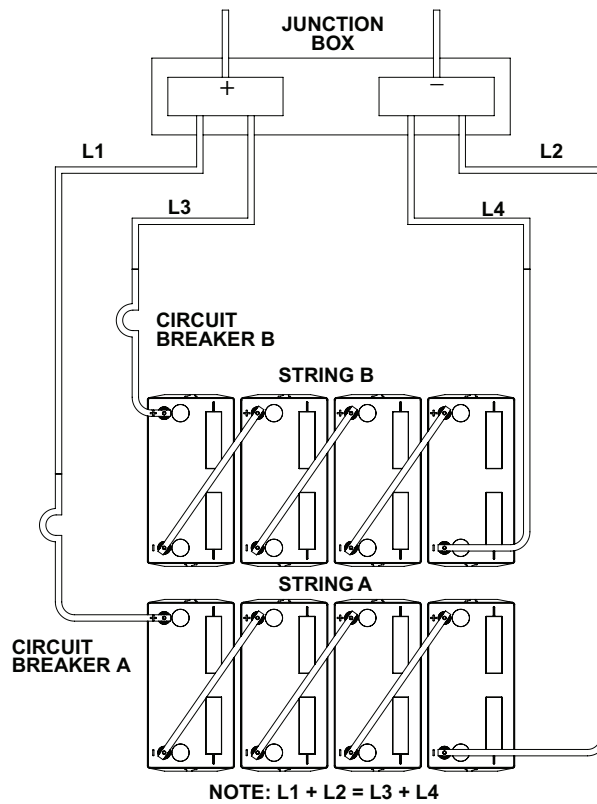

Figure 6 - Parallel Strings with Fault Protection

The following table provides some guidance on what are thought to be practical limits as a function of the system voltage.

System DC Voltage	Rec. Max. Number Parallel Strings	Total Number of 12 VDC Units	Number of Bolted Connections
12 VDC	12 - 16	12 - 16	24 - 32
24 VDC	10 - 12	20 - 24	40 - 48
48 VDC	8 - 10	32 - 40	64 - 80
120 VDC	6 - 8	60 - 80	120 - 160
240 VDC	4 - 6	80 - 120	160 - 240
360 VDC	4 - 6	120 - 180	240 - 360
480 VDC	4	160	320

It is important that parallel strings of batteries be properly maintained since a shorted cell in one string will negatively affect the remaining strings. When a system of parallel strings of batteries is to be deactivated for a period of time, the individual string disconnect switches should be opened so that a shorted cell in one string will not discharge the other strings.

With lower capacity battery strings operated in parallel, the individual strings are sometimes diode isolated from each other as shown in figure 7. In this configuration, individual string disconnect switches may not be required.

Troubleshooting Techniques - When using parallel strings monitoring of the individual strings on charge float current and the discharge current can provide very useful information as to which string may contain defective units.

A disproportionately high float current or low discharge current could indicate the presence of shorted, open or high impedance cells in the string. Similar information on an individual unit basis may be conveniently derived by measuring and comparing the individual unit impedance (ohms) or conductance (mhos) or the AC ripple voltage (millivolts) across the individual battery units.

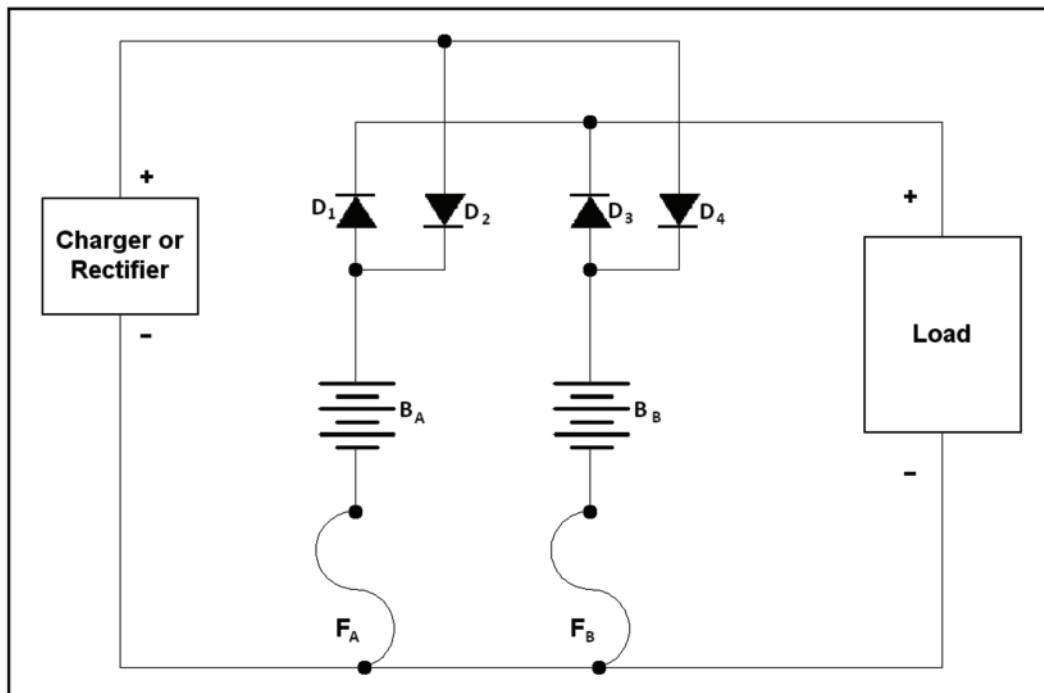

Figure 7 - Parallel Strings with Diode Insulation & Fault Protection



Global Corporate Headquarters 200 Precision Rd.
Horsham, PA 19044
USA customersvc@cdtechno.com
www.cdtechno.com

©2022 C&D Technologies Inc. Any data, descriptions or specifications presented herein are subject to revision by C&D Technologies, Inc. without notice. While such information is believed to be accurate as indicated herein, C&D Technologies, Inc. makes no warranty and hereby disclaims all warranties, express or implied, with regard to the accuracy or completeness of such information. Further, because the product(s) featured herein may be used under conditions beyond its control, C&D Technologies, Inc. hereby disclaims all warranties, either express or implied, concerning the fitness or suitability of such product(s) for any particular use or in any specific application or arising from any course of dealing or usage of trade. The user is solely responsible for determining the suitability of the product(s) featured herein for user's intended purpose and in user's specific application.