

1238CF

Operating Manual
Genelec 1238CF
DSP Loudspeaker

GENELEC®



Introduction

Congratulations and a thank-you for the purchase of this Genelec 1238CF DSP Loudspeaker. This loudspeaker is designed to integrate easily into the digital production environment. There are several ways to configure and operate the DSP loudspeaker for a wide variety of high quality audio applications. The 1238CF also has an analog input, making it a versatile and intelligent replacement for analog loudspeakers.

This manual addresses setting up and using the 1238CF DSP loudspeaker in stand-alone mode without the Genelec Loudspeaker Manager GLM™ and the proprietary Genelec loudspeaker control network. Use with the GLM™ is described in the DSP System Operating Manual.

EC Declaration Of Conformity

This is to certify that Genelec 1238CF DSP loudspeakers conform to the following standards:

Safety: EN 60065: 2002 + A1: 2006 + A11:2008 / IEC 60065: 2001 7th Edition + A1: 2005

EMC: EN 55020: 2007, EN 55013: (2001) + A1: 2003 + A2: 2006
EN 61000-3-2 (2006) and EN 61000-3-3 (1995) + A1: 2001 + A2: 2005

The products herewith comply with the requirements of The Low Voltage Directive 2006/95/EC, EMC Directive 2004/108/EC and Energy related Products (ErP) Directive 2009/125/EC.

Signed:

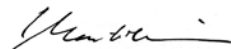

Ilpo Martikainen

Position:

Chairman of the Board

Date:

30-September-2010

Compliance to FCC Rules

This device complies with part 15 of the FCC Rules. Operation is subject to the following two conditions:

- This device may not cause harmful interference, and
- This device must accept any interference received, including interference that may cause undesired operation.

Note: This equipment has been tested and found to comply with the limits for a Class B digital device, pursuant to part 15 of the FCC Rules. These limits are designed to provide reasonable protection against harmful interference in a residential installation. This equipment generates, uses and can radiate radio frequency energy and, if not installed and used in accordance with the instructions, may cause harmful interference to radio communications. However, there is no guarantee that interference will not occur in a particular installation. If this equipment does cause harmful interference to radio or television reception, which can be determined by turning the equipment off and on, the user is encouraged to try to correct

the interference by one or more of the following measures:

- Reorient or relocate the receiving antenna.
- Increase the separation between the equipment and receiver.
- Connect the equipment into an outlet on a circuit different from that to which the receiver is connected.
- Consult the dealer or an experienced radio/TV technician for help.

Modifications not expressly approved by the manufacturer could void the user's authority to operate the equipment under FCC rules.

Safety Considerations

Although the 1238CF has been designed in accordance with international safety standards, to ensure safe operation and to maintain the loudspeaker under safe operating conditions, the following warnings and precautions must be observed:

- Servicing and adjustment must only be performed by qualified service personnel. The loudspeaker enclosure must not be opened.
- Do not use this product with an unearthed mains cable or a mains connection without the protective earth contact as this may lead to personal injury.
- To prevent fire or electric shock, do not expose the unit to water or moisture.
- Do not place any objects filled with liquid, such as vases on the loudspeaker or near it.
- Note that the amplifier is not completely disconnected from the AC mains service unless the mains power cord is removed from the amplifier or the mains outlet.
- Free flow of air behind the loudspeaker is necessary to maintain sufficient cooling.
- Do not obstruct airflow around the loudspeakers.
- Note that the amplifier is not completely disconnected from the AC mains service unless the mains power cord is removed from the amplifier or the mains outlet.

WARNING!

The Genelec 1238CF loudspeaker is capable of producing sound pressure levels in excess of 85 dB, which may cause permanent hearing damage.

System

The Genelec 1238CF DSP Loudspeaker is designed for precise monitoring of 24 bit/192 kHz AES/EBU digital audio signal or line level analog audio signal. The 1238CF is fully compatible with Genelec Loudspeaker Manager GLM™ and the proprietary Genelec loudspeaker control network and Genelec 7271A DSP Active Subwoofer, but can also be used independently of these. The 1238CF features high SPL output and low colouration in

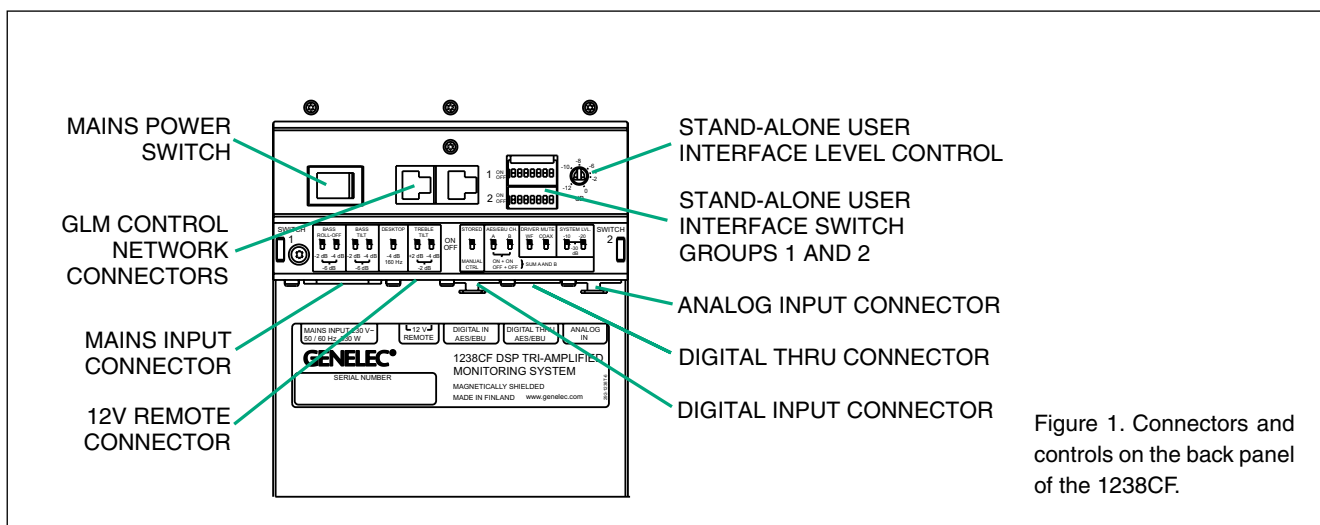

Figure 1. Connectors and controls on the back panel of the 1238CF.

a small enclosure size. It is suitable for a wide variety of tasks, such as near field monitoring, mobile vans, broadcast and TV control rooms, surround sound systems and home studios. The advanced Directivity Control Waveguide™ (DCW™) technology provide excellent frequency balance even in difficult acoustic environments.

Amplifiers

The amplifier unit is mounted in the rear of the loudspeaker enclosure. The unit incorporates special circuitry for driver thermal overload protection. Variable input sensitivity allows accurate level matching to console output section.

Using the Loudspeakers in Stand-Alone Mode

The 1238CF accepts both analogue line level input signals and AES/EBU formatted digital input signals.

When the loudspeakers are not connected to a Genelec loudspeaker control network, they operate in stand-alone mode. However, settings made with the Genelec Loudspeaker Manager software can be saved into each loudspeaker and applied even when the network is disconnected by setting switch 1 “STORED/MANUAL CONTROL” on switch group 2 of each loudspeaker to position “STORED.”

This manual concentrates on using the loudspeakers without the control network. All issues concerning use with the network are explained in detail in the System Operating Manual provided with the GLM™ Loudspeaker Manager software kit.

Connections

Each loudspeaker is supplied with a mains cable, one 5 m GLM

network cable and an operating manual. Before connecting up, ensure that the mains switch is off.

“MAINS INPUT” Connector

Connect the mains supply to this connector.

“DIGITAL IN AES/EBU” Connector

Use this female XLR connector for AES/EBU formatted digital audio input signals. This input is selected automatically when a valid digital audio signal is present, and overrides the analogue input.

Depending on the digital hardware, transmission of a 192 kHz sample rate is achieved using a double speed, single channel/cable interface. This is called dual-wire mode. In this case one cable per channel is used and no channel selection is required. Dual-wire mode is automatically detected by the input stage.

If the digital source device has a digital level monitor pot or graphical volume fader that controls the digital level, it may be advantageous to lower the level control either on the GLM software interface or the loudspeaker’s back panel controls rather than the source device, which in turn will force the use of more of the digital [bit] resolution in the volume control.

If the digital input is used, audio levels are referenced to 0 dBFS (digital Full Scale, the largest level that may be represented in the AES/EBU signal). Genelec DSP loudspeakers produce 100 dB SPL at 1 meter in free space for a digital input signal of –30 dB FS. It is advantageous to keep the digital level as high as possible.

“DIGITAL THRU AES/EBU” Connector

This male XLR carries an unaltered copy of the digital signal fed into the “DIGITAL IN AES/EBU” connector. It can be used for daisy-chaining up to four loudspeakers together.

“ANALOG IN” Connector

Use this connector for analog audio signals. When operating an 1238CF in the analog mode the A/D converter must not be overloaded, otherwise distortion will be heard. The maximum input level is +22.0 dBu RMS. When A/D converter input clip occurs the front panel light turns momentarily red, indicating the overload condition.

If the “Level” control on the back panel is reduced (turned counter-clockwise), the acoustic output will be reduced. This control decreases the output from the D/A converters. Ideally the Level control should be set to force the use of more of the input range of the A/D converter without overloading it. Remember, there is no headroom above the maximum input to the A/D conversion.

“CONTROL NETWORK” Connectors

Use these RJ-45 sockets to connect the loudspeaker to the proprietary Genelec Loudspeaker Manager™ (GLM™) network only. This connector is not Ethernet LAN compatible. Do not connect to Ethernet LAN.

“12 V REMOTE” Connector

You can set up remote controlled powering up and down of the 1238CF with 12 V 60 mA trigger voltage connected to this connector.

Front Panel Warning Light

Normally the light on the front panel of a 1238CF loudspeaker is green, indicating that the loudspeaker is in normal operational mode.

The overload light (red) is activated by several events,

- exceeding the maximum input range of the analog input
- exceeding the maximum input range of the digital input with large probability
- exceeding the output capacity of the power amplifier (clipping in the power amplifier) and thermal overload of the power amplifier or loudspeaker drivers (thermal protection has activated)
- if an error is detected in the AES/EBU audio data

If a red warning light appears, turn the source down! If the levels are already modest and a digital signal is being used, ensure that there are no bit errors in the AES/EBU digital audio data.

Mounting Considerations

Align the Loudspeakers Correctly

Always place the loudspeakers so that their acoustic axes are aimed towards the listening position (see Figure 2). Vertical placement is mandatory to maintain cooling behind the loudspeaker.

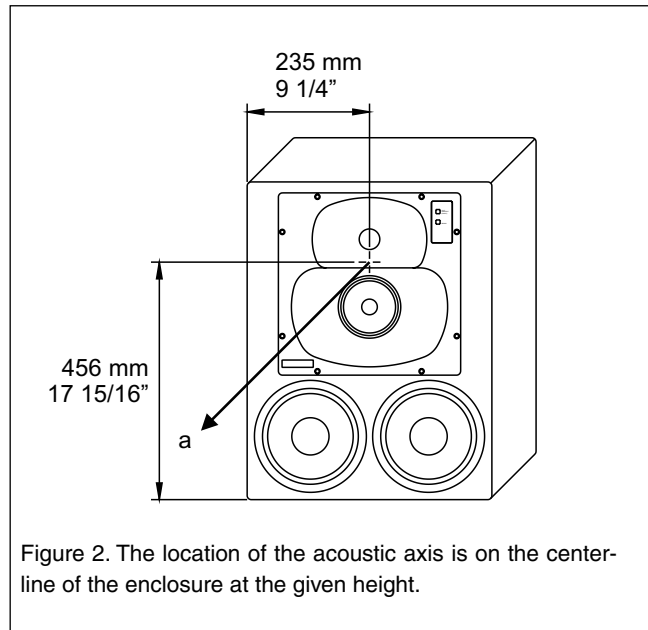

Figure 2. The location of the acoustic axis is on the centerline of the enclosure at the given height.

Maintain Symmetry

Check that the loudspeakers are placed symmetrically and at an equal distance from the listening position. If possible, place the system so that the listening position is on the centerline of the room and the loudspeakers are placed at an equal distance from the centerline.

Minimise Reflections

Acoustic reflections from objects close to the loudspeakers like desks, cabinets, computer monitors etc. can cause unwanted colouration and blurring of the sound image. These can be minimised by placing the loudspeaker clear of reflective surfaces. For instance, putting the loudspeakers on stands behind and above the mixing console usually gives a better result than placing them on the meter bridge. Symmetrical positioning of the reflective objects is also important in order to maintain a balanced soundstage.

Minimum Clearances

Sufficient cooling for the integrated amplifier must be ensured if the loudspeaker is installed in a restricted space such as a cabinet, or integrated into a wall structure. The surroundings of the loudspeaker must always be open to the listening room with a minimum clearance of 5 centimeters (2”) behind, above and on both sides of the loudspeaker. The space adjacent to the loudspeaker must either be ventilated or sufficiently large to dissipate heat so that the ambient temperature does not rise above 35 degrees Celsius (95°F).

Setting the Input Sensitivity

The loudspeaker level sensitivity functions for both analog and digital input. The sensitivity can be matched by adjusting the rotary Level control together with the System Level switches lo-

cated in the switch group 2. (switches 6 and 7). The switches provide attenuation levels of -10 dB (sw. 6 ON), -20 dB (sw. 7 ON) and -30 dB (both switches ON) The combined attenuation ranges from 0 to -42 dB.

Functions On Switch Group 1 (Tone Controls)

Switch group 1 (the upper switch group) comprises the tone controls that can be used to adjust the frequency response of the system in stand-alone mode to match the acoustic environment.

Please note that the GLM Loudspeaker Controller allows a much more versatile and precise set of controls to be used and supports the fully automatic system alignment feature, Genelec AutoCal. Use the tone control switches on the loudspeaker only if a GLM is not available for for calibrating the system.

The controls are labelled “TREBLE TILT”, “BASS TILT”, “BASS ROLL-OFF” and “DESKTOP”. The factory settings for these controls are all “OFF” to give a flat anechoic response. Note that these controls have no effect when switch 1 “STORED/MANUAL CONTROL” on switch group 2 is set to “STORED” or when the loudspeaker is connected to the Genelec loudspeaker control network.

Bass Roll-Off Control

Bass Roll-Off control (switches 1 and 2) affects the low frequency roll-off of the loudspeaker and attenuates its output near the cut-off frequency. Attenuation levels of -2 dB (sw. 1 ON), -4 dB (sw. 2 ON) or -6 dB (both switches ON) can be selected.

Bass Tilt Control

The Bass Tilt control switches (switches 3 and 4) offer three attenuation levels for the bass response below 800 Hz, usually necessary when the loudspeakers are placed near room boundaries. The attenuation levels are -2 dB, -4 dB and -6 dB.

Desktop Low Frequency Control

The desktop low frequency control (switch 5) attenuates the bass frequencies around 160 Hz by 4 dB. This feature is designed to compensate for the boost often occurring at this frequency range when the loudspeaker is placed upon a meter bridge, table or similar reflective surface.

Treble Tilt Control

Treble Tilt control (switches 6 and 7) allows adjusting the treble response above 5 kHz by +2 dB, -2 dB or -4 dB, which can be used for correcting an excessively bright or dull sounding system or to compensate for high frequency level loss if the loudspeaker is placed behind a screen.

An acoustic measuring system such as WinMLS is recommended for analyzing the effects of the adjustments, however, careful listening with suitable test recordings can also lead to good results if a test system is not available. Table 1 shows some typical settings in various situations.

Loudspeaker Mounting Position	Treble Tilt	Bass Tilt	Bass Roll-Off	Desktop
Flat anechoic response	None	None	None	None
Free standing in a damped room	None	-2 dB	None	None
Free standing in a reverberant room	None	-4 dB	None	None
Near field on a reflective surface	None	-2 dB	None	-4 dB
In a corner	None	-4 dB	-4 dB	None

Table 1. Suggested Tone Control settings in some typical situations.

Always start adjustment by setting all switches to “OFF” position. Measure or listen systematically through the different combinations of settings to find the best frequency balance. See Table 1 for some typical settings in various situations.

Functions On Switch Group 2

Stored / Manual Ctrl

This allows the selection between two basic methods of controlling the loudspeaker in the stand-alone mode. “MANUAL CTRL” refers to controlling the loudspeaker using the controls on the loudspeaker’s back panel. The “STORED” refers to using settings stored inside the memory of the loudspeaker. These settings are made using GLM and the GLM Control Network. There is additional functionality compared to that offered by the room response correction switches on the back panel.

AES/EBU CH

This selects the audio channel(s) available on the AES/EBU cable to be reproduced by the loudspeaker. Turning both switches on reproduces the sum of the two channels on the AES/EBU cable. Turning both switches off has the same effect which has been done deliberately to avoid the situation where no input channel is selected and the loudspeaker is effectively muted. When two channels are selected, 6 dB of attenuation is automatically applied to avoid overloading the loudspeaker.

If the AES/EBU cable is operated in dual-wire mode (typically 192 kHz sampling frequency) one AES/EBU cable carries only one audio channel. The loudspeaker detects this situation automatically and the channel selection switches have no effect.

Driver Mute

These two switches allow you to mute the treble and midrange drivers (marking DCW) or bass driver (marking “WF”) independently. This may be useful to diagnose if a transducer is faulty.

System Lvl

These switches allow scaling down of the loudspeaker output. The signal sent to the “Thru” output connector is not affected. The switches are additive, for example, “-30 dB” attenuation is

achieved by turning on the “-10 dB” and “-20 dB” switches. The effect of these switches is combined with the effect of the rotary level adjustment control. This results in total possible attenuation of 42 dB, 30 dB by the system level switches and another 12 dB by the rotary control.

Using 7000 Series Analog Subwoofers with the 1238CF DSP Loudspeakers

Genelec recommend the use of DSP subwoofers (7200 Series) with DSP loudspeakers. However, it is also possible to use analog subwoofers. Please follow the steps below to integrate an analog subwoofer into a system of DSP loudspeakers:

- Connect cables carrying analog audio to the 7000 Series analogue subwoofer first.
- Connect the subwoofer outputs to the analog inputs of the 1238CF DSP loudspeakers.
- Connect the GLM Control Network to the loudspeakers.
- Make a System Setup in GLM. It will consist of only loudspeakers as this is all the network can see, so suitable Rapid Cabling Presets are “Stereo Pair (Analog)” and “5.0 Surround System (Analog)”.
- Run AutoCal and review the results to check for large dips at or above 85 Hz. Move the loudspeakers and repeat AutoCal if there is a problem.
- Press “Finish”, then in the Main Page select “Menu | Store Acoustic Settings to All Online Loudspeakers” and close GLM.
- For each DSP loudspeaker, turn it off, select “Stored” on the back of each loudspeaker to enable the internal Acoustic Settings, and then turn it on again.
- To set the phase control on the subwoofer, connect the Center channel output of the subwoofer to the loudspeaker to be used to align phase.
- Follow the instructions in the subwoofer user manual for setting phase and level.

Maintenance

No user serviceable parts are to be found within the loudspeaker enclosure. Any maintenance or repair of the loudspeaker should only be undertaken by qualified service personnel.

Guarantee

The Genelec 1238CF is supplied with two year guarantee against manufacturing faults or defects that might alter the performance of the loudspeakers. Refer to supplier for full sales and guarantee terms.

Accessories

A wide selection of accessories is available for Genelec loudspeakers. Consult the Accessories Catalogue on www.genelec.com or your local distributor/dealer for up-to-date information.

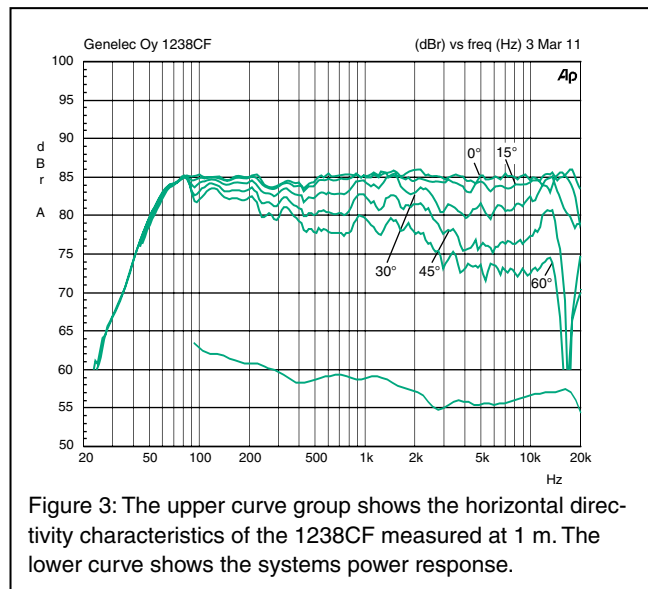

Figure 3: The upper curve group shows the horizontal directivity characteristics of the 1238CF measured at 1 m. The lower curve shows the systems power response.

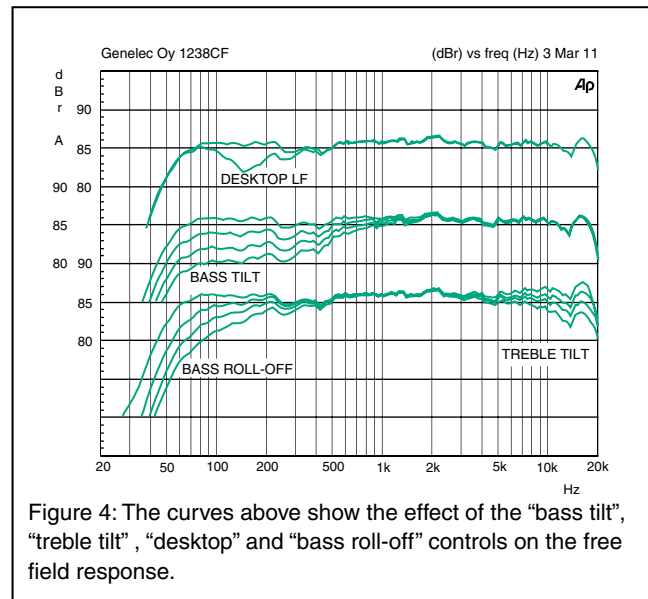

Figure 4: The curves above show the effect of the “bass tilt”, “treble tilt”, “desktop” and “bass roll-off” controls on the free field response.

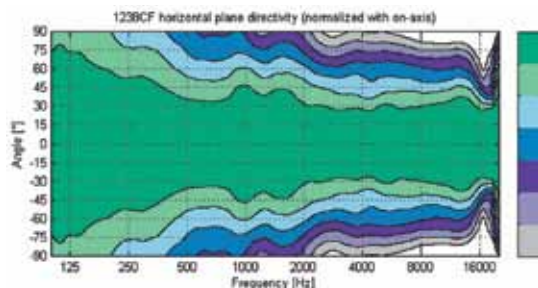

Figure 5: Horizontal directivity of the 1238CF.

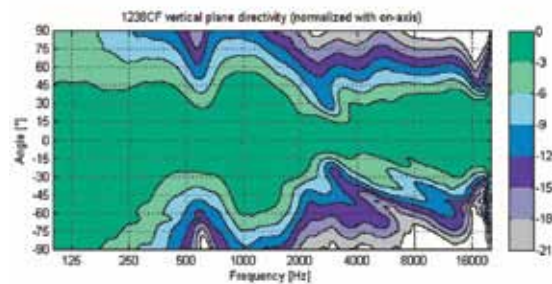

Figure 4: Vertical directivity of the 1238CF.

SYSTEM SPECIFICATIONS

	1238CF
Lower cut-off frequency, -3 dB	< 55 Hz
Upper cut-off frequency, -3 dB	> 20 kHz
Free field frequency response	57 Hz – 20 kHz (± 2.0 dB)
Maximum short term sine wave acoustic output on axis in half space, averaged from 100 Hz to 3 kHz	@ 1 m > 117 dB SPL
Maximum long term RMS acoustic output in same conditions with IEC weighted noise (limited by driver unit protection circuit)	@ 1 m > 107 dB SPL
Maximum peak acoustic output per pair with music material	@ 2 m > 124 dB
Self generated noise level in half space at 1 m on axis (A-weighted)	< 15 dB
Harmonic distortion at 90 dB SPL at 1 m on axis Freq: 60...100 Hz > 100 Hz	< 1 % < 0.5 %
Drivers Bass Midrange Treble	2 x 210 mm (8") cone 125 mm (5") cone 25 mm (1") metal dome All drivers are magnetically shielded
Weight	42 kg (93 lb)
Dimensions Height Width Depth	610 mm (24") 470 mm (18 1/2") 257 mm (10 1/8")

AMPLIFIER SECTION

	1238CF
Bass amplifier short term output power	150 W at 4 Ohm load
Midrange amplifier short term output power	120 W at 8 Ohm load
Treble amplifier short term output power	120 W at 8 Ohm load
Long term output power is limited by driver unit protection circuitry	
Slew rate	80 V/us
Amplifier system THD at nominal output	< 0.05 %
Signal to Noise ratio, referred to full output Bass Midrange Treble	>100 dB >100 dB >100 dB
Mains voltage Mains voltage operating range	100/200 or 115/230 V -10 to +10 %
Power consumption (average) Idle Full output	23 VA 330 VA

SIGNAL PROCESSING SECTION

	1238CF
Digital signal input connector XLR female 110 kOhm	AES/EBU Single Wire or Dual Wire
Digital signal output / Thru connector XLR male 110 kOhm	AES/EBU Single Wire or Dual Wire
Analog signal input connector XLR female, balanced 10 kOhm	pin 1 gnd, pin 2 +, pin 3 -
Digital audio Word length Sample rate	16 - 24 bits 32 - 192 kHz
Control network Type Connection	Proprietary GLM™ network 2 RJ45, CAT5 cables
Crossover frequency Bass/Mid Mid/Treble	420 Hz 2.8 kHz
GLM™ software frequency response adjustment * Notch filters Shelving filters	4 LF and 2 HF 2 LF and 2 HF
System calibration	Auto Cal™, Stand-alone

* The notch and shelving filters adjustments, AutoCal™ and GLM™ manual system calibration features are part of the Genelec Loudspeaker Manager (GLM™) software

1238CF Operating Manual

Genelec Document D0100R001 Copyright Genelec Oy 10.2010. All data subject to change without prior notice

www.genelec.com

GENELEC®

International enquiries:

Genelec, Olvite 5
FIN-74100, Iisalmi, Finland
Phone +358 17 83881
Fax +358 17 812 267
Email genelec@genelec.com

In the U.S. please contact:

Genelec, Inc., 7 Tech Circle
Natick, MA 01760, USA
Phone +1 508 652 0900
Fax +1 508 652 0909
Email genelec.usa@genelec.com

In Sweden please contact:

Genelec Sverige
Ellipsvägen 10B
P.O. Box 5521, S-141 05 Huddinge
Phone +46 8 449 5220
Fax +46 8 708 7071
Email info@genelec.com

In China please contact:

Beijing Genelec Audio Co.Ltd
Jianwai SOHO, Tower 12,
Room 2605
D-1504, Chaoyang District
Beijing 100022, China
Phone +86 10 8580 2180
Fax +86 10 8580 2181
Email genelec.china@genelec.com