

HT324AC

Operating Manual
Genelec HT324AC
Three-Way Active Loudspeaker

GENELEC®



System

The GENELEC HT324AC active loudspeaker is designed for neutral sound reproduction at high SPLs in large Home Theater rooms. Its cabinet has been designed for optimum placement in the limited space above or below a video screen, but it can also be installed in vertical configuration. Acoustically the HT324AC is identical to Genelec HT324A. The system consists of a 160 litre loudspeaker cabinet and a 19" 7U rack mount amplifier unit.

The cabinet contains two 305 mm (12") bass drivers, a 130 mm (5") midrange, and a 25 mm (1") treble driver. The midrange and treble drivers are mounted in a Genelec Directivity Control Waveguide™ (DCW™) which can be rotated through ±90° for either horizontal or vertical mounting. The cabinet low frequency -3 dB point is at 32 Hz and the bass response extends down to 27 Hz. The high frequency response extends up to 22 kHz (-3 dB).

Each amplifier unit contains a three-channel active crossover, driver overload protection circuits, and four separate power amplifiers producing 2 x 400 W, 350 W and 120 W of short term power in the bass, midrange, and treble channels respectively. The crossover filter incorporates tone controls to enable the user to accurately match the speaker to the local acoustic environment.

Unpacking

The Genelec HT324AC is shipped in a single box, containing a cabinet, an amplifier unit, a mains connecting cable, a LED connecting cable, a loudspeaker connecting cable and one Allen key. (See Fig 1)

Before installing the system, check all items for damage and omissions. If there are any damaged products, contact directly the distributor and insurance agent. If there are any missing components, contact your local dealer or Genelec.

Installing the amplifier

The Genelec HT324AC amplifier electronics is encased in an standard 19" 7U rack chassis. The unit should be well ventilated to prevent overheating, there must be a supply of air to the front and sufficient ventilation to dissipate the generated heat from the space behind the amplifier unit. The maximum permissible ambient temperature is 35° C (95° F) If the system overheats it will stop operat-

ing until a safe temperature is reached.

Each amplifier unit has been calibrated at the factory with the loudspeaker cabinet it is packed with. They also share the same ID number. Make sure that each amplifier is connected to the cabinet bearing the same ID number when installing multiple loudspeakers.

Make sure that the amplifier is positioned so that the loudspeaker connecting cables will reach. Longer cable lengths can be ordered from the manufacturer upon special request. A space 120 mm deep should be left behind the rear panel of the amplifier unit to allow for the cable connectors.

Check that the amplifier unit is wired to the correct mains voltage for your power supply. The correct mains voltage for the amplifier unit is shown at the bottom of the sticker on the rear panel of the amplifier unit.

The amplifier mode can be switched between ON and standby modes by a remote control unit connected to the respective 12 V DC trigger inputs on the amplifier back panel. Activate the function by turning the "REMOTE CONTROL" dip switch on the amplifier panel to "ON".

Loudspeaker positioning

The HT324AC is designed to be flush mounted in either the vertical or horizontal configuration. The DCW™ should be rotated so that the treble and midrange drivers align vertically. This ensures that optimum symmetry is obtained.

Note that the DCW™ plate is heavy, care must therefore be taken when removing and replacing the DCW™. To rotate the DCW™ plate, proceed as follows:

- Place the loudspeaker in its intended listening orientation.
- Unscrew the eight M5 fixing screws on the edges of the plate using the 4 mm Allen key provided with the system.
- Carefully pull the plate a small distance away from the cabinet.
- Rotate the DCW™ so that the midrange and treble drivers are aligned vertically (treble driver on top) and remount the DCW™ plate reversing the procedure above.

Flush mounting of the loudspeaker

Although the HT324AC may be used successfully as a free standing loudspeaker,

flush mounting is strongly recommended for acoustical reasons. Flush mounting improves the bass response and efficiency and also enhances the midrange transient and frequency response.

The loudspeaker has its acoustical axis midway between the midrange and treble drivers. This axis should be used as the listening and measuring axis of the system. (See Fig 1)

The listening position should be between 2 ... 3.5 m (6½ ... 11½') from the loudspeakers. The loudspeaker should be aimed so that the acoustical axis of the two loudspeakers meet at ear height at the center of the listening area. The loudspeakers should not be mounted too high as this increases the required vertical tilt of the loudspeaker and reduces the optimum listening area.

The ceiling, side walls and especially the rear wall should be acoustically absorbent at low frequencies. The loudspeaker mounting wall should be acoustically hard and therefore reflective. The mounting wall should be angled so that the loudspeakers are correctly aimed. Great care should be taken over how the loudspeaker is mounted into the wall.

Note the following:

- A space 50...100mm (2..4") wide can be left around the loudspeaker.
- Cover the space around the loudspeaker with a facing panel, this should be fixed tilt to the wall. Leave a gap of about 5..10 mm (¼..½") between the loudspeaker and the panel. Fill this gap with a soft rubber gasket to allow for possible cabinet movement.
- Ensure that the loudspeaker cables can reach the rear of the loudspeakers.
- If a light (e.g. wooden) wall is used, the loudspeaker cabinet should be mounted on vibration isolators, with a resonant frequency of around 2...8 Hz, to prevent vibrations from being transmitted to the wall and impairing the low frequency performance. The space around the cabinet should be filled with absorbent mineral wool or foam plastic. The walls must be well braced.
- For a solid wall (e.g. concrete), the loudspeaker may be directly mounted to the wall without vibration isolators. The space around the cabinet should be filled with mineral wool or sand bags.

Discontinuities in the mounting wall will cause diffraction, which leads to inferior frequency response and stereo imagery, so:

- Ensure that the cabinet is flush with the surface of the wall.
- If a decorative cloth frame is used to cover the wall, make sure that the edges adjacent to the speaker are less than 20 mm (3/4") deep. The cloth must be very thin Tricot or acoustically transparent material, otherwise the high frequency response of the system will be adversely affected. Genelec approved cloth grilles are available).

Recess for loudspeaker connectors

A space at least 120 mm (4 3/4") deep must exist to allow for the cable connectors behind the loudspeaker. The dimensions of the recess should be at least 100 x 140 x 75 mm (4" x 5 1/2" x 3"), as shown in Fig. 6. Note that the connectors are positioned off-center. Therefore, if the loudspeaker is rotated for a left and right channel, the recess will be at different heights on the left and right side. This occurs when the loudspeakers are mounted in the horizontal configuration.

Connecting cable

The two connecting cables have different types of connectors at each end, a loudspeaker connector and an LED connector. The loudspeaker connector is larger than the LED connector. Insert the connectors into the appropriate sockets found on the rear panel of the amplifier unit and the rear of the loudspeaker.

To insert the connectors proceed as follows:

- Insert the connectors into the sockets and turn the connectors clockwise. The connectors lock automatically.
- The electrical connections are only made when the connectors are fully inserted.

To remove the connectors pull the release lever on the connector and turn the connector counterclockwise simultaneously. The connector can now be removed from the socket.

Acoustical Setup

Input sensitivity adjustment

The input sensitivity of the HT324AC can be adjusted to match the output signal level of the signal source. This is done by turning the 'Input sensitivity' trimmer, which is accessed

Speaker mounting environment	Control				
	Bass Roll-Off	Bass Tilt	Bass Level	Mid Level	Treble Level
Flat anechoic response (factory setting)	All OFF	All OFF	All OFF	All OFF	All OFF
Free standing in a heavily damped room	All OFF	-2 dB ON	All OFF	All OFF	All OFF
Free standing in a reverberant room	All OFF	-2 dB ON	-1 dB ON	All OFF	All OFF
Flush mounted in a hard wall	All OFF	-4 dB ON	-1 dB ON	All OFF	All OFF
In a corner	-4 dB ON	-6 dB ON	-2 dB ON	All OFF	All OFF

Table 1. Suggested starting positions for tone controls.

through the front panel of the amplifier unit. However, an accurate left/right balance is obtained when the trimmer is set to the fully clockwise 'cal' position. Leaving the input sensitivity trimmer in the 'cal' position is therefore recommended.

To obtain the maximum sound pressure level of 123 dB SPL, with the input sensitivity set to -6 dBu, a signal level of +20 dBu is required.

Tone control adjustment

The frequency response of the system should be adjusted to match the listening room's acoustic environment. This adjustment is made using the tone controls, 'BASS TILT', 'BASS ROLL-OFF', 'BASS LEVEL', 'MIDRANGE LEVEL', and 'TREBLE LEVEL'. These controls are accessed through the amplifier unit's front panel. The default setting of these controls is in the 'OFF' position, which yields a flat frequency response when the speaker is operated in an anechoic environment. Note that only one switch in each control group should be in the 'ON' position.

The room normally boosts the low frequencies compared with free field conditions. To get a flat room response, adjustments to the bass tone control switches are usually required. See table 1 for suggested starting positions of the tone controls in four different room types. The table shows that the mid-range and treble controls should be left in their free field positions, since these frequencies are controlled by the speaker more than the room. Acoustical measurements, and precise listening tests should be completed by qualified personnel, to determine the optimum tuning in each case.

Measuring the frequency response

The overall sound balance experienced at the listening position can, to a certain extent, be measured with steady state signals (e.g. pink noise, warble sine etc.) and a corresponding frequency analyser. However, the results obtained are very sensitive to the measuring methods and the equipment used.

Recommended Measuring Equipment

1. Microphone

- Always use a laboratory grade measurement microphone.
- B&K 4134 (or similar) for far field, 4133 or 4165 (or similar) for near field below 8kHz.
- B&K 4004 and 4007 (or similar) up to 8kHz.

Do not use a microphone having a polar pattern other than omnidirectional, or one not having an accurately known frequency response.

2. Signal Source

Use a signal source which is suitable for the type of analyser being used. Do not use a noise generator which is integrated into a mixing console, since these signal generators tend to have a very coarse spectrum content and are not intended to be used for measurement purposes.

3. Analyser

Any professional quality real time analyser or tracking plotter can be used. (1/3 or 1/1 octave analysis is usually sufficient for frequency response balancing)

Near field measurement

This measurement gives an indication of the

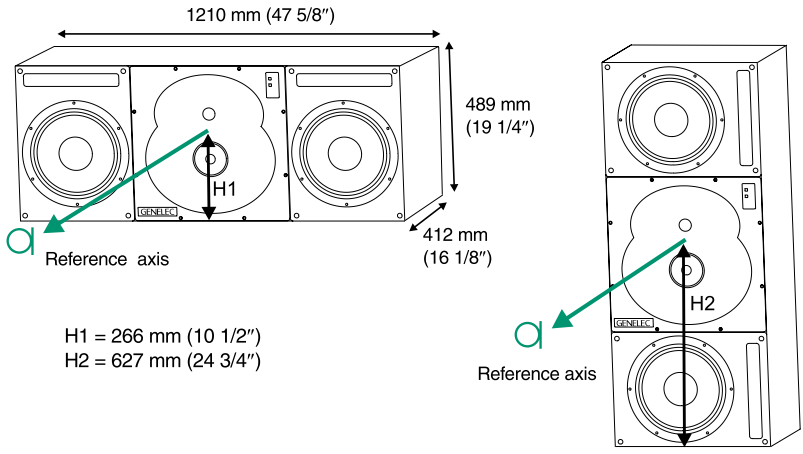

Fig 1. Location of the acoustic axis in horizontal and vertical configurations. Note the alignment of the DCW.

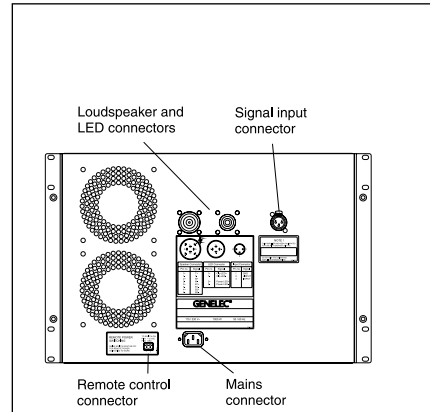

Fig 2. Amplifier unit connectors.

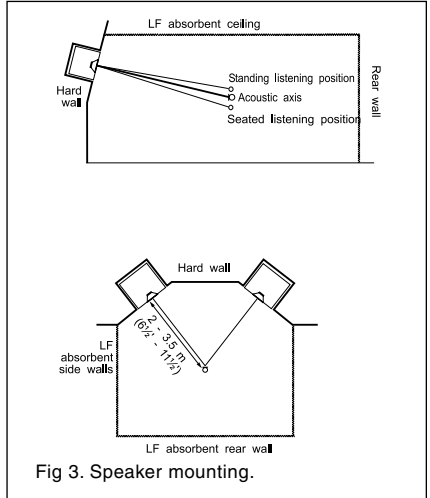

Fig 3. Speaker mounting.

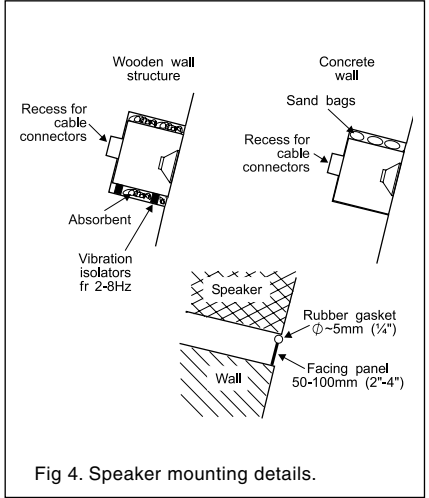

Fig 4. Speaker mounting details.

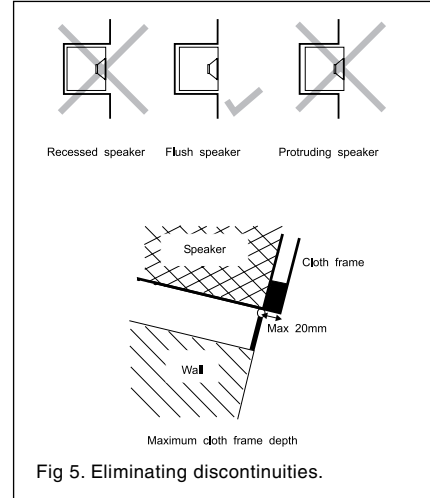

Fig 5. Eliminating discontinuities.

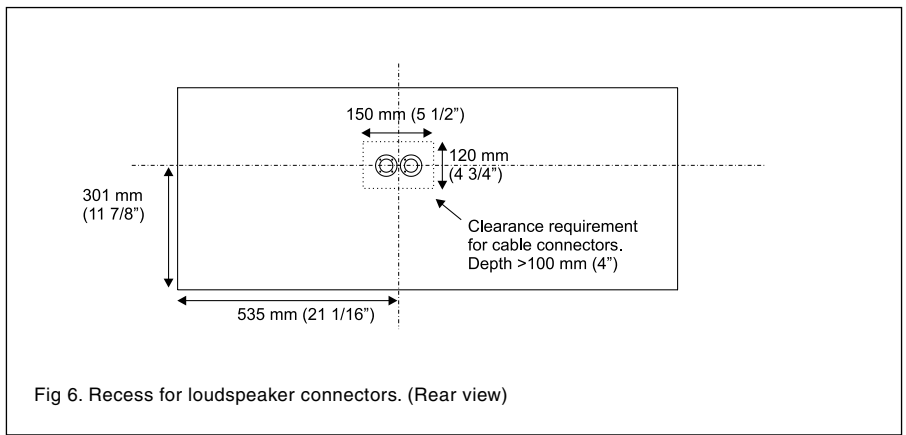

Fig 6. Recess for loudspeaker connectors. (Rear view)

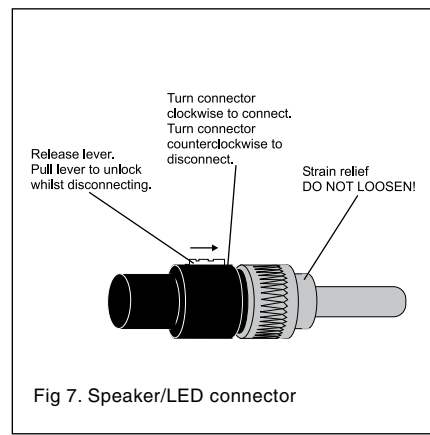

Fig 7. Speaker/LED connector

direct sound radiation of the loudspeaker below 1 kHz.

- Set the microphone 1 m away from the loudspeaker on the acoustic axis. (See Fig 1)
- Measure the frequency response of the speaker, and adjust the tone controls to achieve a flat frequency response below 1kHz.

Make sure that any sound reflecting objects such as chairs etc. are removed from the close proximity of the loudspeaker.

Listening position measurement

Once the near field frequency response measurement has been made, the frequency response at the listening position can be determined by the same means. When comparing the results, the following items should be noted.

1. High frequency roll-off

This is due to the following physical factors:

- Increasing room and air absorption with higher frequencies.
- Increasing loudspeaker and microphone directivity with increasing frequency.

2. Low frequency irregularities.

These are caused by:

- Insufficient standing wave absorption in the control room.
- Reflections from nearby boundaries (Floor, ceiling, walls) interfering with direct sound.

Incorrect vertical speaker alignment can cause interference dips at the upper crossover frequency (around 3.2 kHz). Hence care should be taken aiming the speaker correctly towards the listening position. (See Fig 3.)

Overload indicators

Each loudspeaker is provided with two LED's marked 'CLIP PROTECT (FAULT)' and 'READY'. The green 'READY' LED indicates that the amplifier system power is switched on, and that the speaker is ready for use. The red 'CLIP PROTECT (FAULT)' LED indicates that the amplifier system is overloaded or that the driver protection circuit is activated. If the red LED lights, reduce the signal level so that the LED stops blinking. If this LED stays lit constantly, the amplifier thermal protection circuitry has activated. Let the amplifier cool down, and

ensure that the amplifier is adequately ventilated.

Maintenance

There are no user serviceable parts within the amplifier unit. Any maintenance of the unit should only be undertaken by qualified service personnel. Ensure that only fuses of the appropriate voltage and current ratings are used if a fuse has to be replaced. REMEMBER to disconnect the power supply by removal of the mains cable before changing a fuse. Clean the amplifier unit's air filter every six months, or more frequently in dusty environments. The air filter is located behind the grille, found to the left of the front panel. The air filter can be cleaned with a vacuum cleaner without removing the grille.

Safety considerations

Although the HT324AC has been designed in accordance with international safety standards, to ensure safe operation and to maintain the instrument under safe operating conditions, the following warnings and cautions should be observed:

- Servicing and adjustment must only be performed by qualified service personnel. The loudspeaker or the amplifier must not be opened.
- The amplifier must only be connected to mains socket outlet with a protective earthing connection.
- Do not use the amplifier with an unearthed mains cable as this may compromise electrical safety.
- Do not expose the loudspeaker or the amplifier to water or moisture. Do not place any objects filled with liquid, such as vases, on the loudspeaker or near it.
- Do not place naked flame sources like lighted candles on or near the loudspeaker or the amplifier.
- This loudspeaker is capable of producing sound pressure levels in excess of 85 dB, which may cause permanent hearing damage.
- Proper ventilation of the amplifier is necessary to maintain sufficient cooling. Ensure that air flows freely into the openings on the amplifier front panel and that the space behind the amplifier is sufficiently ventilated to dissipate the generated heat.
- Note that the amplifier is not completely disconnected from the AC mains service

unless the mains power cord is removed from the amplifier or the mains outlet.

Guarantee

This product is guaranteed for a period of one year against faults in materials or workmanship. Refer to supplier for full sales and guarantee terms.

EC Declaration of Conformity

This is to certify that Genelec HT324AC loudspeaker conforms to the following standards:

Safety:

EN 60065 / IEC 60065:1998 7th Edition

EMC:

EN 55013: (2001)

EN 55020: (1994), A11: (1996), A12: (1999),

A13: (1999), A14: (1999)

EN 61000-3-2 (2000)

EN 61000-3-3 (1995)

The product herewith complies with the requirements of The Low Voltage Directive 73/23/EEC, EMC Directive 89/336/EEC and 93/68/EEC

Signed:

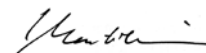

Ilpo Martikainen

Position: Chairman of Board

Date: 16-January-2006

HT324AC Operating Manual

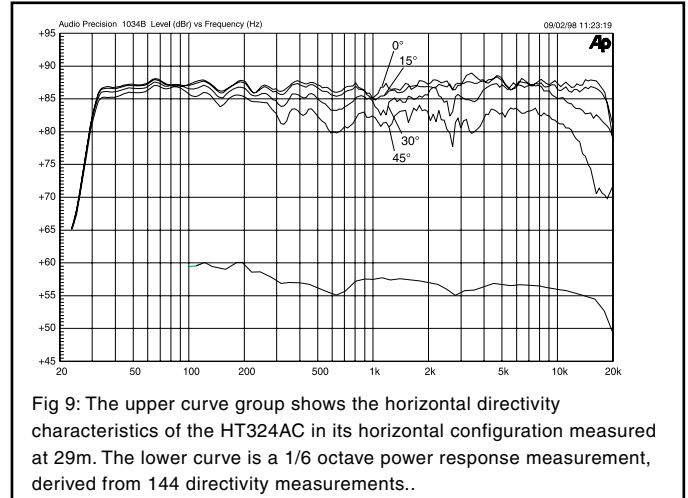
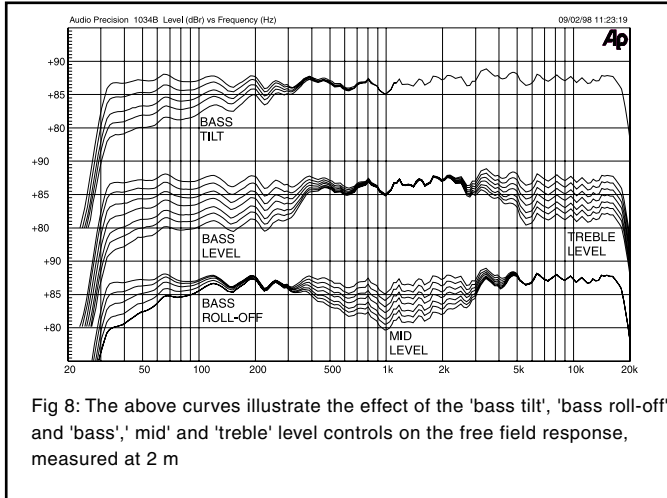

SYSTEM SPECIFICATIONS

Lower cut-off frequency, -3 dB: ≤ 32 Hz
 Upper cut-off frequency, -3 dB: ≥ 20 kHz
 Free field frequency response of system:
 33 Hz - 20 kHz (± 2.5 dB)

Maximum short term sine wave acoustic output on axis in half space, averaged from 100 Hz to 3 kHz @ 1 m ≥ 123 dB SPL
 Maximum long term RMS acoustic output in same conditions with IEC-weighted noise (limited by driver unit protection circuit) @ 1 m: ≥ 118 dB SPL

Maximum peak acoustic output per pair @ 2 m from the engineer with music material: ≥ 125 dB

Self generated noise level in free field @ 2 m on axis: ≤ 15 dB(A)
 Harmonic distortion at 100 dB SPL @ 1 m on axis:
 Freq: 50...200 Hz <1%
 200...10kHz <0.5%

Drivers:
 Bass 2 x 305 mm (15") cone
 Mid 1 x 130 mm (5") cone
 Treble 1 x 25 mm (1") metal dome

Weight: Speaker 84 kg (185 lb)
 Amplifier 30 kg (66 lb)

Speaker dimensions (Horizontal mounting):
 Height 489 mm (19 1/4")
 Width 1210 mm (47 5/8")
 Depth 412 mm (16 1/8")

*Amplifier dimensions:
 Height 310 mm (12³/₁₆")
 Width 483 mm (19")
 Depth 250 mm (9¹³/₁₆")*

CROSSOVER SECTION

Bass amplifier output power with an 8Ω load:
 Short term 2 x 400 W
 Mid amplifier output power with a 8Ω load:
 Short term 350 W
 Treble amplifier output power with an 8Ω load:
 Short term 120 W
 Long term output power is limited by driver unit protection circuitry.

Slew rate: 80 V/μs
 Amplifier system distortion at nominal output:
 THD $\leq 0.05\%$
 SMPTE-IM $\leq 0.05\%$
 CCIF-IM $\leq 0.05\%$
 DIM 100 $\leq 0.05\%$

Signal to Noise ratio, referred to full output:
 Bass ≥ 100 dB
 Mid ≥ 100 dB
 Treble ≥ 100 dB

Mains voltage: 100/200 or 115/230V
 Voltage operating range at
 230V setting: 207 - 244 V (-10/+6 %)
 115V setting: 104 - 122 V (-10/+6 %)

Power consumption:
 Idle 70 W
 Full output 1000 W

AMPLIFIER SECTION

Input connector: XLR female pin 1 gnd
 pin 2 +
 pin 3 -

Input impedance: 10 kOhmΩ balanced

Input level for 100 dB SPL output @ 1m:
 variable from +6 to -6 dBu

Input level for maximum short term output of 126 dB SPL @ 1m:
 variable from +32 to +20 dBu

Subsonic filter below 25 Hz : 18 dB/octave
 Ultrasonic filter above 22 kHz: 12 dB/octave

Crossover frequencies:
 Bass/Mid 400 Hz
 Mid/Treble 3.2 kHz

Crossover acoustical slopes: >24 dB/octave

Level control operating range in 1 dB steps:
 Bass from 0 to -6 dB & MUTE
 Mid from 0 to -6 dB & MUTE
 Treble from 0 to -6 dB & MUTE

Bass roll-off control in 2 dB steps:
 from 0 to -8 dB @ 32 Hz

Bass tilt control operating range in 2 dB steps:
 from 0 to -8 dB @ 50 Hz

The 'CAL' position is with all tone controls set to 'off' and input sensitivity control to maximum and corresponds to a maximally flat free field response.