













Pos	Øjvind	5,4 x 4,4 + 2,0	58x135	Profile	Length	St.
D5 C7					4391	2
D6 C8					2479	2
E6 B2					5400	16
D3 C3					4400	14
C4					4400	1
A3					5400	1
D1 C1					4271	8
D2 C2					2359	8
C6					1137	14
A2					1060	28
E2					1500	4
E5					1500	2
E4 C9 D7					400	8
C5 D4 E3					258	44
B1 A1					5400	2
E1					1500	2
A4 B4 E7	APEX				5400	3
23	Roof board - Dachbrett - Madrier du toit - Tavola tetto - Tabla de tejado			19 x 85	2880	162
24	Window - Fenster - Fenetre - Finestra - Ventana			2126 x 966		1
25	Door - Tür - Porte - Porta - Puerta			3280 x 1938		1
27	Facia board - Giebelblende - Ecran frontal - Schermo frontone - Tabla de facia			20 x 145 or 20 x 120	2930	4
28	Roof of cover fixture			20 x 95	2950	4
35	Beam			40 x 40	3435	4
36	Purlin - Dachpfette - Arbaletrier - Arcareccio - Correa				4520	4
37					2608	4
36\1	Purlin - Dachpfette - Arbaletrier - Arcareccio - Correa				4391	1
37\1					2479	1
37	Amrest			20 x 95	1972	2
					1272	2
					675	2
38	Diamond - Deckbrett - Madrier - Tavola di copertura - Rombo					2
E8	Beam			40 x 40	2025	2

Pos	Øvind	Profile	Length	St.
	SCREW FOR WINDOW / DOOR CROSS SLOT STRAIGHT		3x20	48
	SCREW		4x40	16
	SCREW FOR GABLE MOULDING, FOR EAVES BOARDS, FOR EDGE REINFORCEMENT		4x50	110
	SCREW		5x70	6
				10
	NAIL FOR ROOF		2,5x50	700
				2
	SCREW FOR DOOR		5x70	8
	DOOR HANDLE FITTINGS			1
	DOOR LOCK COVER			1
	CYLINDER LOCK			1
	HINGE FOR DOOR			6
	WINDOW HANDLE FITTINGS + 2 BOLT FOR WINDOW HANDLE FITTINGS			3

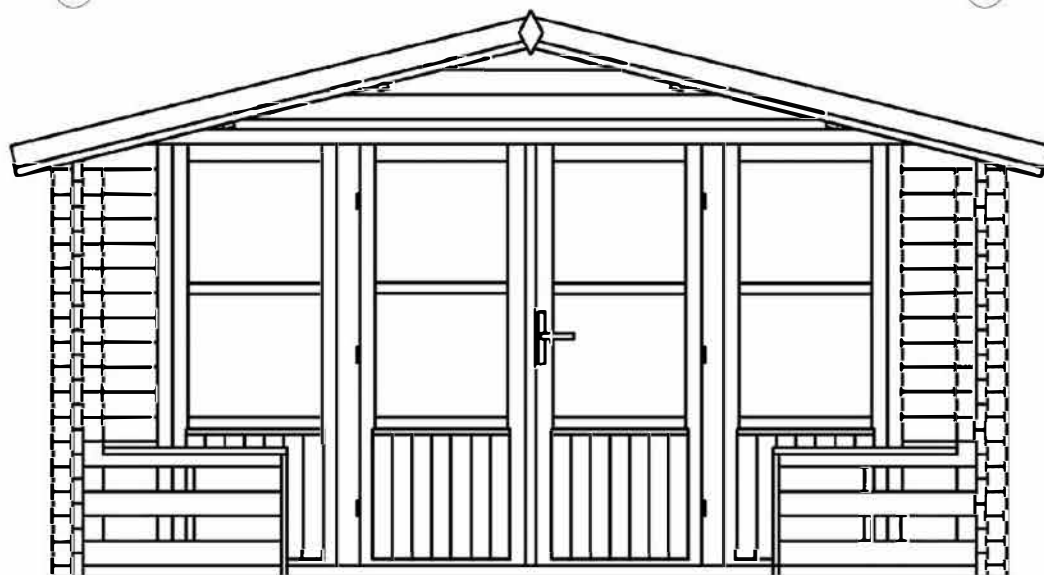
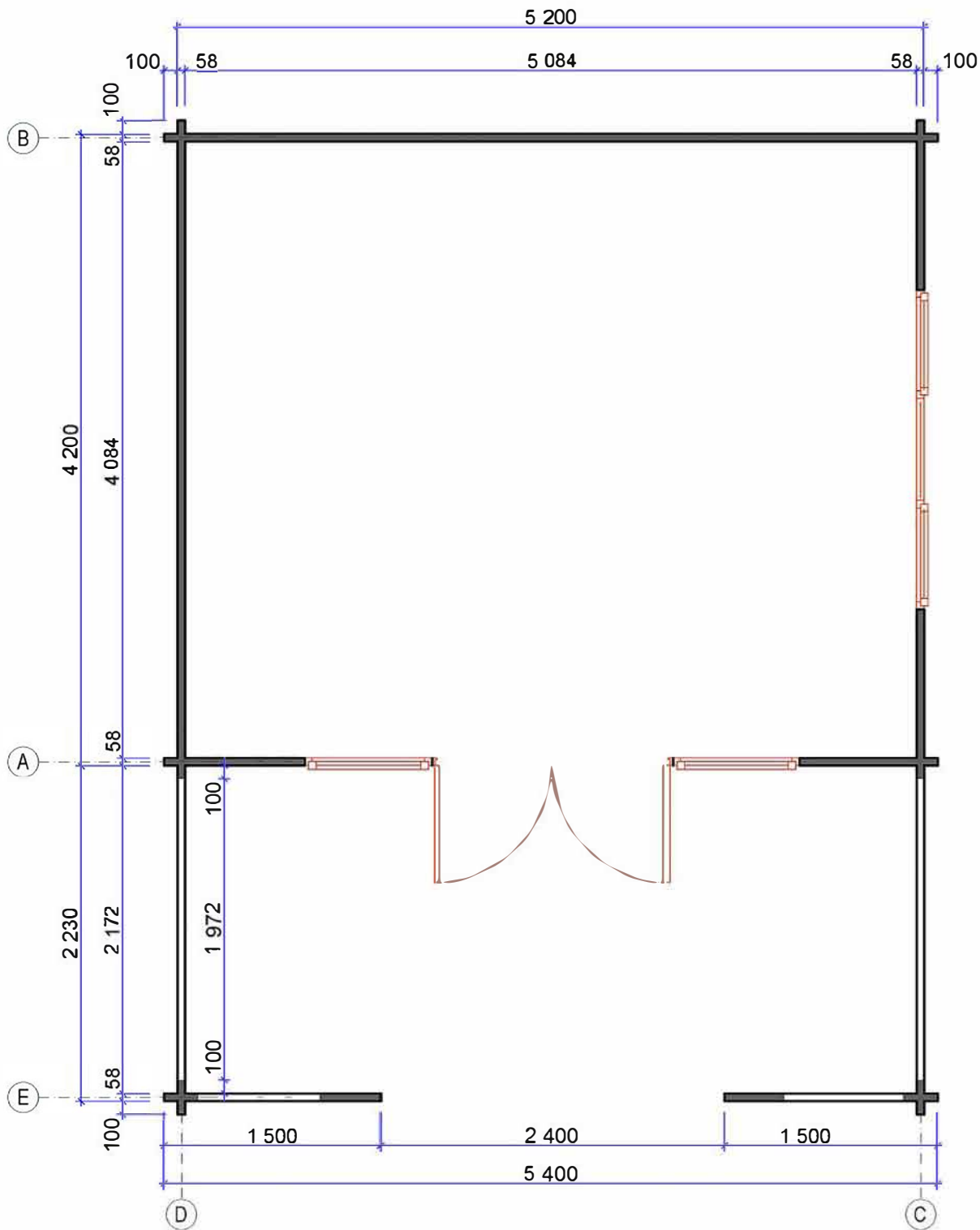

Øjvind

5,4 x 4,4 + 2,0 58\135 mm

Wall B

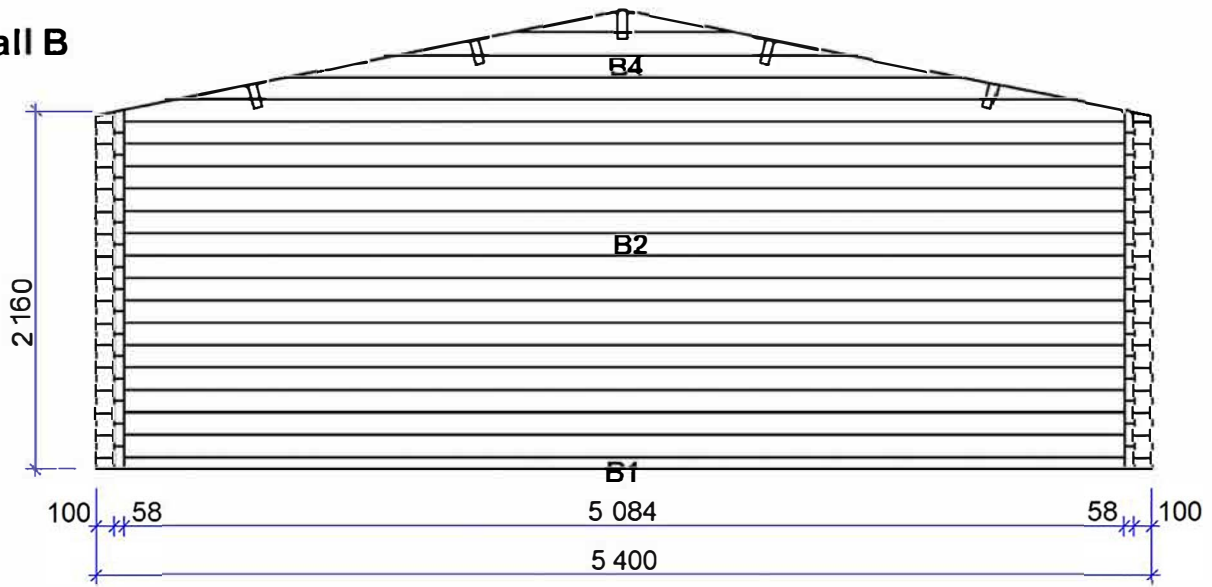

Wall A

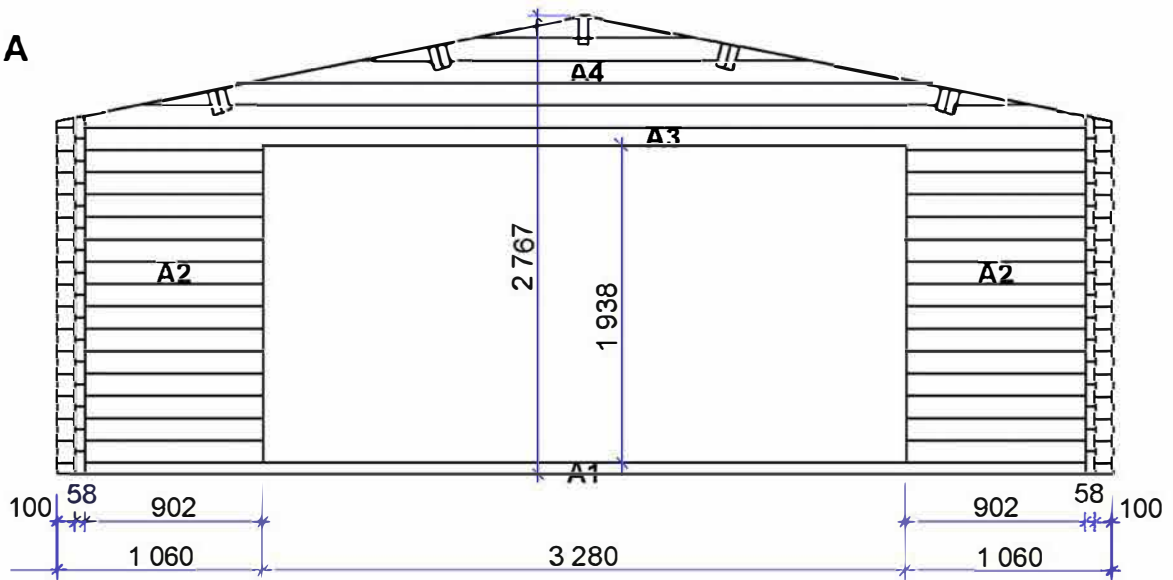

Wall E

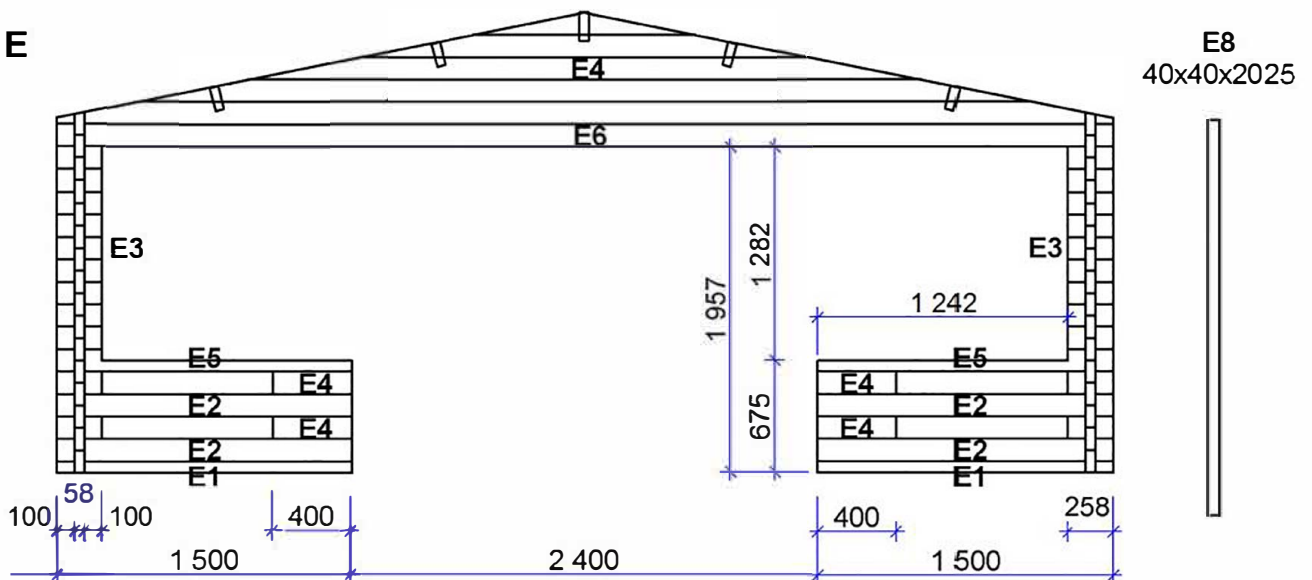

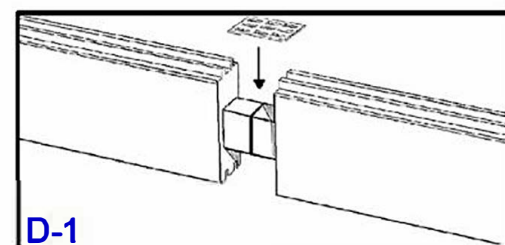
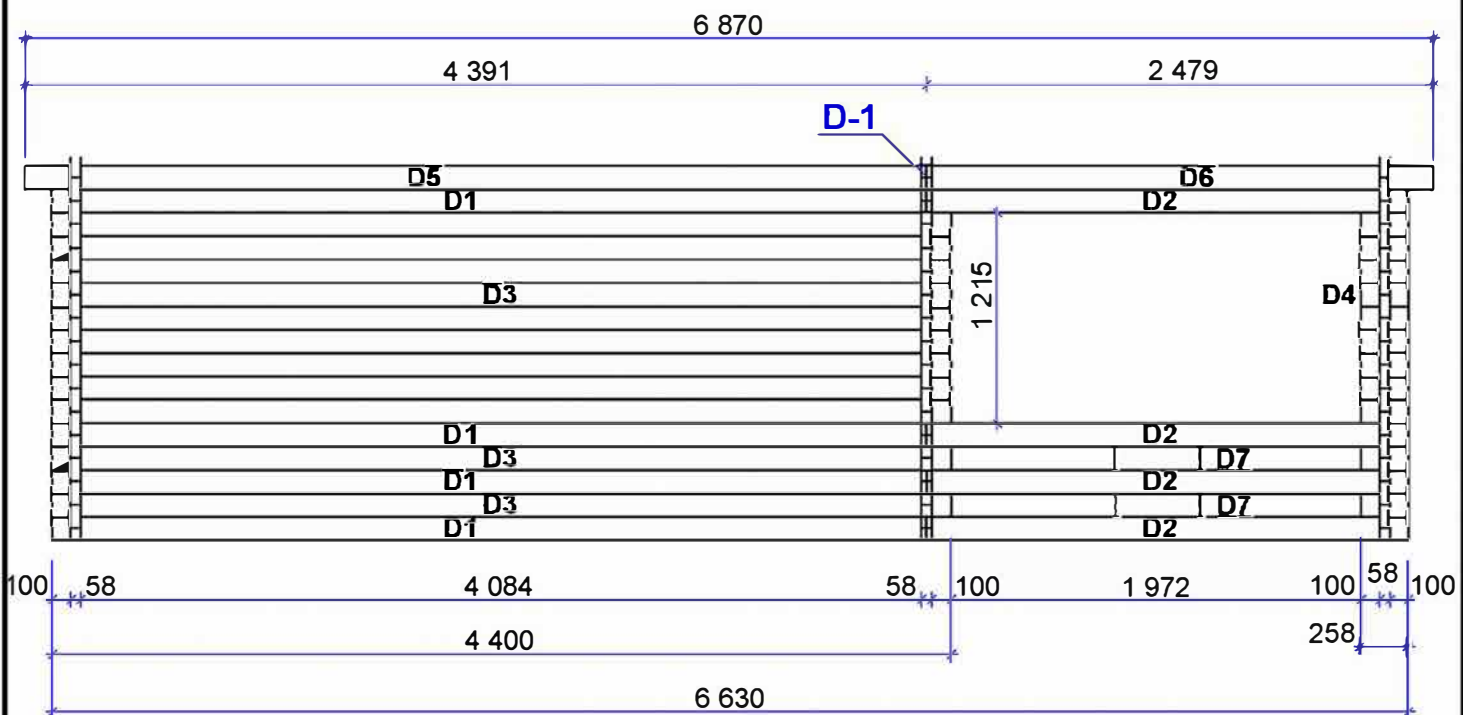
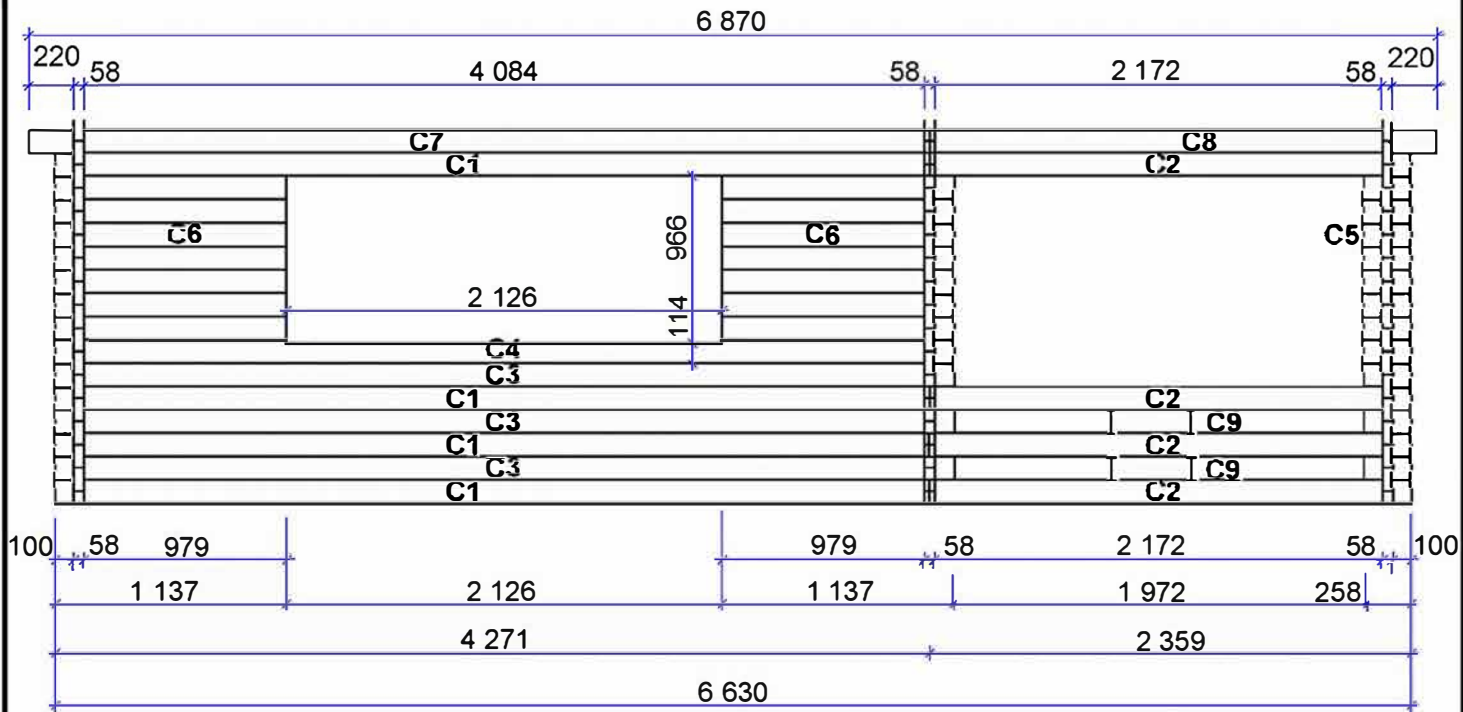

Øjvind

5,4 x 4,4 x 2,0 58\135 mm