

Kood	Alva - 2018	Leht
Joonis		Mootkava 1:50
Materjal	4,0 x 13,5	Kuup. 16.11.2017
Joonestas	File -	2018.d

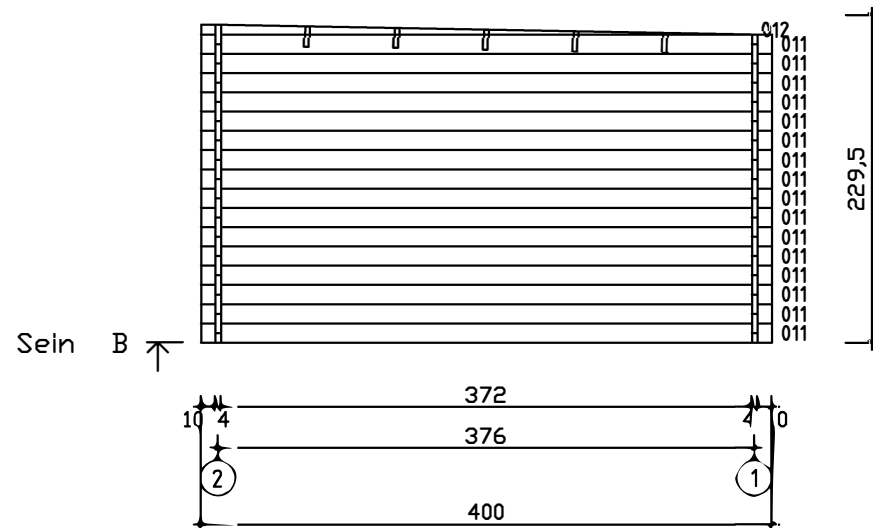

Kood Alva Joonis - 2018	Leht 2
SEIN A Materjal	Mootkava 1:50
4.0x13.5	Kuup. 16.11.2017
Joonestas	File Alva - 2018.d

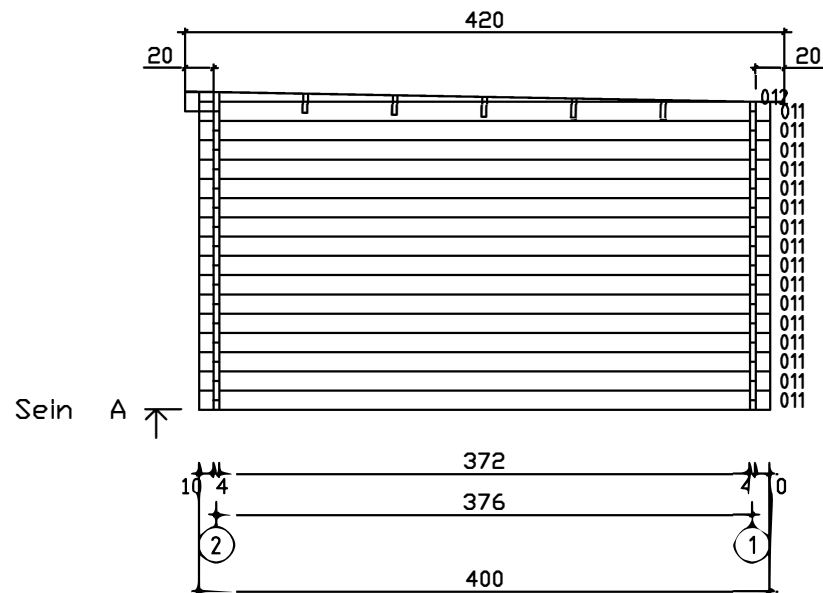
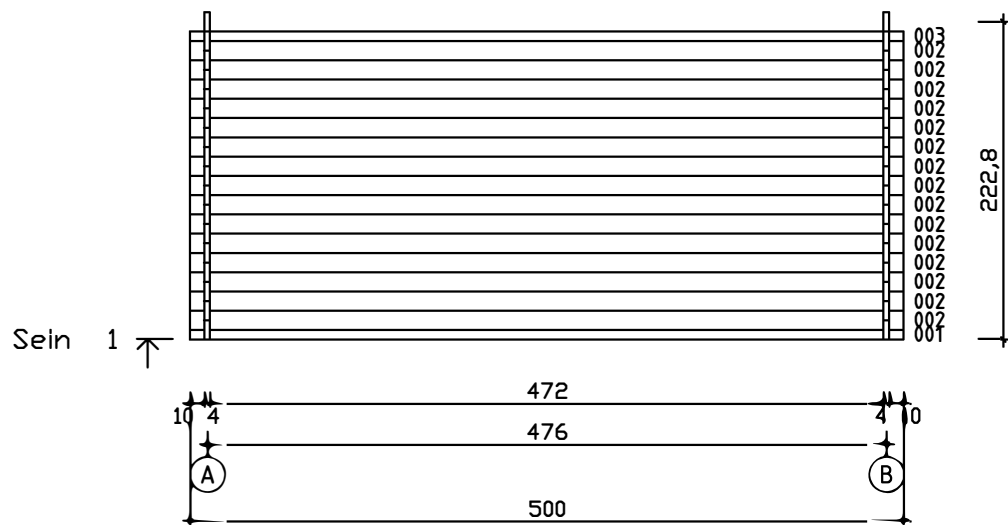
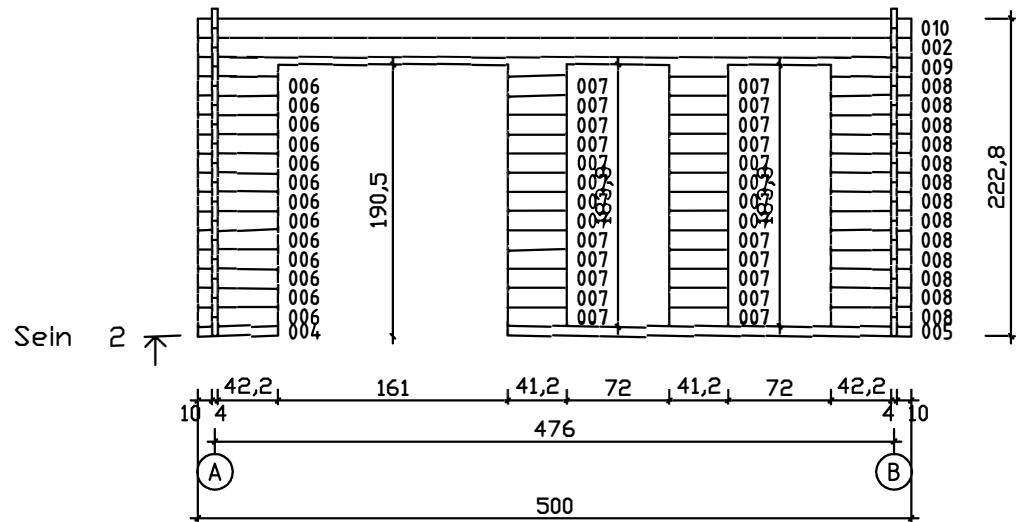

Kood Alva - 2018 Joonis	Leht 4
SEIN 1	Mootkava 1:50
Materjal 4.0x13.5	Kuup. 16.11.2017
Joonestas	File Alva - 2018.d

4.0x13.5

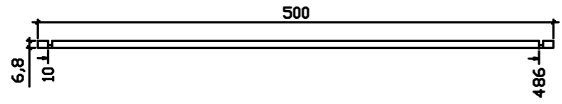

001 /1

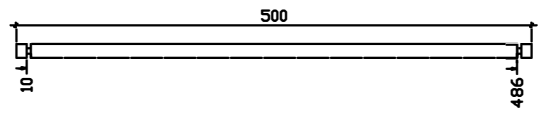

002 /16

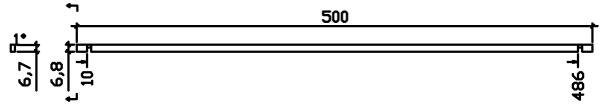

003 /1

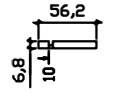

004 /1

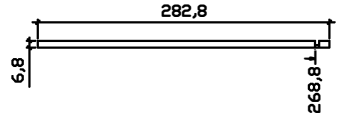

005 /1



006 /13



007 /26

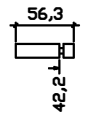

008 /13

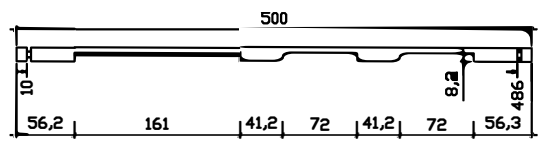

009 /1

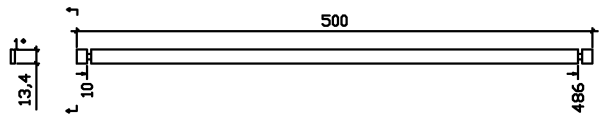

010 /1

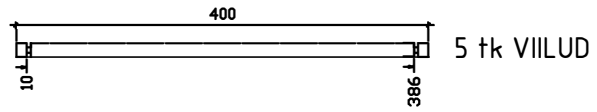

011 /32

4.0x13.5

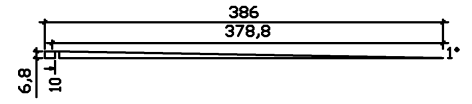

012 /2

PÕHIPÄRLINID

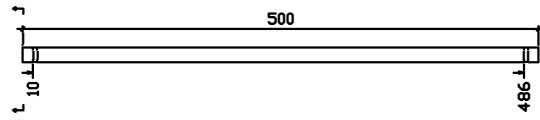





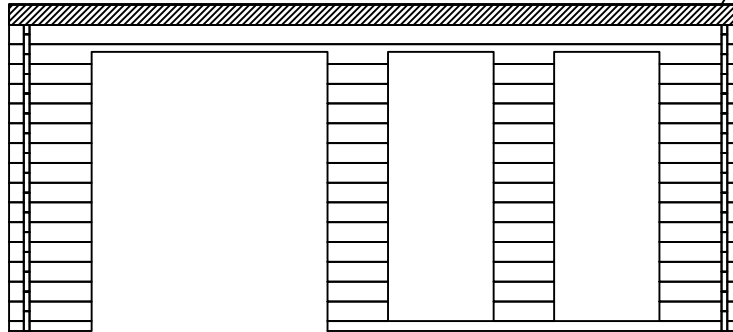

PR1 /5
4.3x14.5(3.3x14)

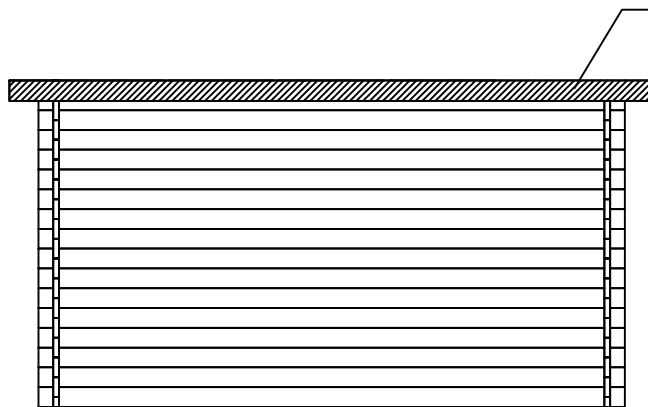
nr: 019

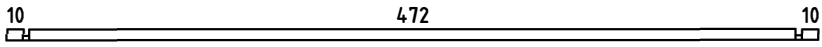
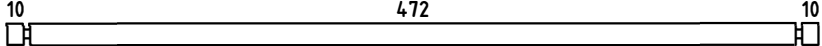
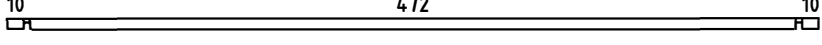
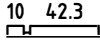
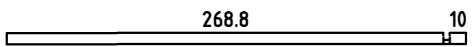
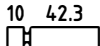

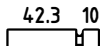
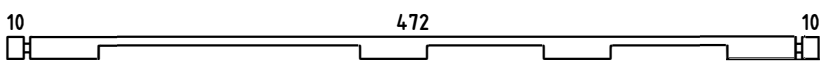
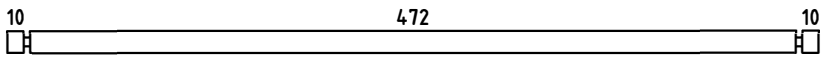
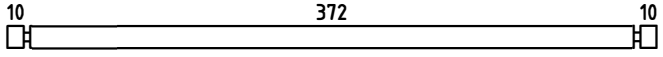
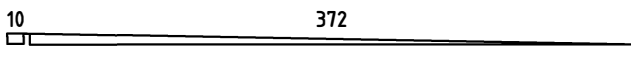
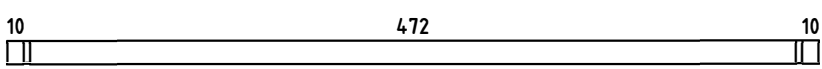
nr: 018



Pos	Drawing Annabel - 2018	Pcs	Profile (cm)	Length (cm)	
001		1	4x6.8	500	
002		16	4x13.5	500	
003		1	4x6.8	500	
004		1	4x6.8	56.2	
005		1	4x6.8	282.8	
006		13	4x13.5	56.2	
007		26	4x13.5	41.3	
008		13	4x13.5	56.3	
009		1	4x13.5	500	
010		1	4x13.5	500	
011		32	4x13.5	400	
012		2	4x6.8	386	
PR1		5	4.3x14.5	500	
	WINDOW 70x181.3	2			
	DOOR 159x188	1			
013	ROOF BOARDS/DACHBRETTER/VOLIGE 	45 37	11.2x1.6 13.7x1.6	420 420	
014	ROOF EDGE REINFORCEMENT/TRAUFENLEISTE/TASSEAU 	2	2.6x3.2	500	
015	FASCIA BOARD/GIEBELBLENDE/PLANCHE DE RIVE (FACADE) 	2	1.8x14.0	420	
016	FASCIA BOARD/GIEBELBLENDE/PLANCHE DE RIVE (FACADE) 	2	1.8x14.0	503.6	
Kood Alva - 2018		Materjal		File Alva - 2018.dwg	Leht 1/1