

Date rev. Description

V 1.0

House	Hugin-34	Sheet	1
Drawing	3D	Scale	
Material	34x135	Date	21.10.2019
Drawer	K.K.	File	Hugin-34 3D.dwg

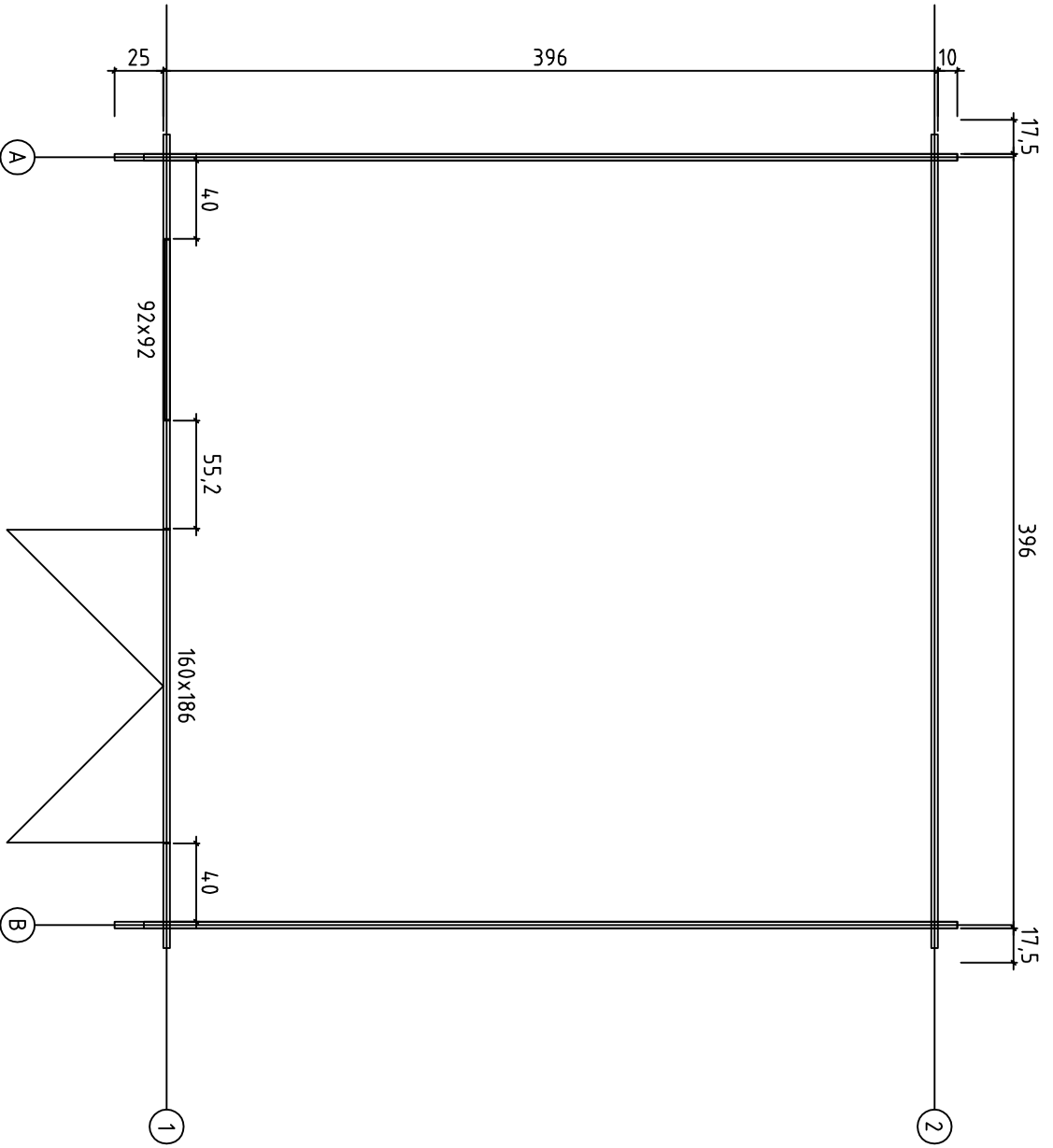

House	Hugin-34	Sheet	2
Drawing	Plan	Scale	1:35
Material	34x135	Date	24.10.2019
Drawer	K.K.	File	Hugin-34.dwg

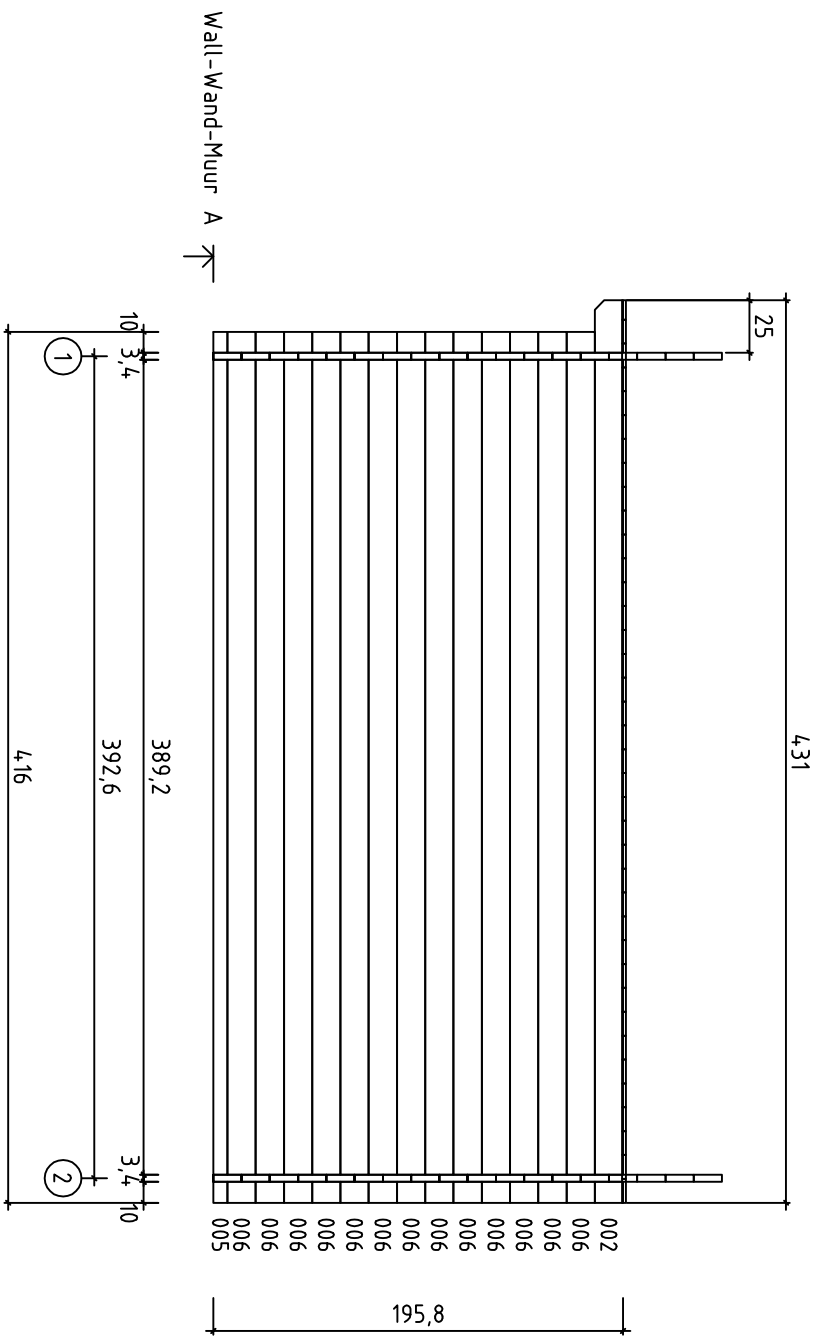

House	Hugin-34	Sheet	3
Drawing	WALL-WAND-MUUR A	Scale	1:35
Material	3,4x13,5	Date	24.10.2019
Drawer	K.K.	File	Hugin-34.dwg

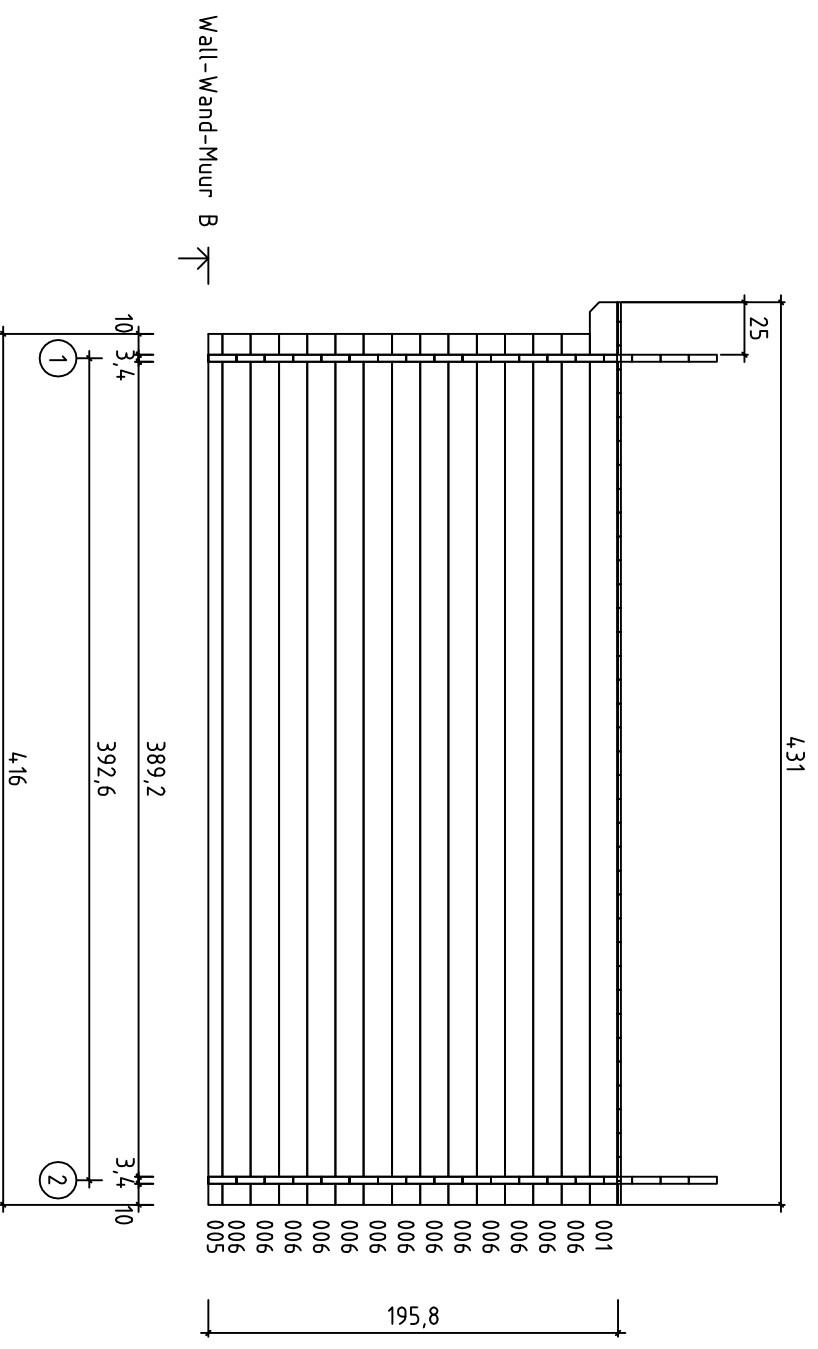

House	Hugin-34	Sheet	4
Drawing	WALL-WAND-MUUR B	Scale	1:35
Material	3,4x13,5	Date	24.10.2019
Drawer	K.K.	File	Hugin-34.dwg

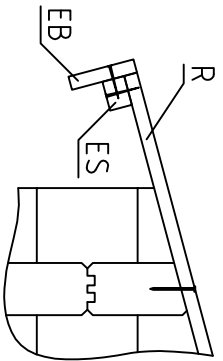

Wall-Wand-Muur 1

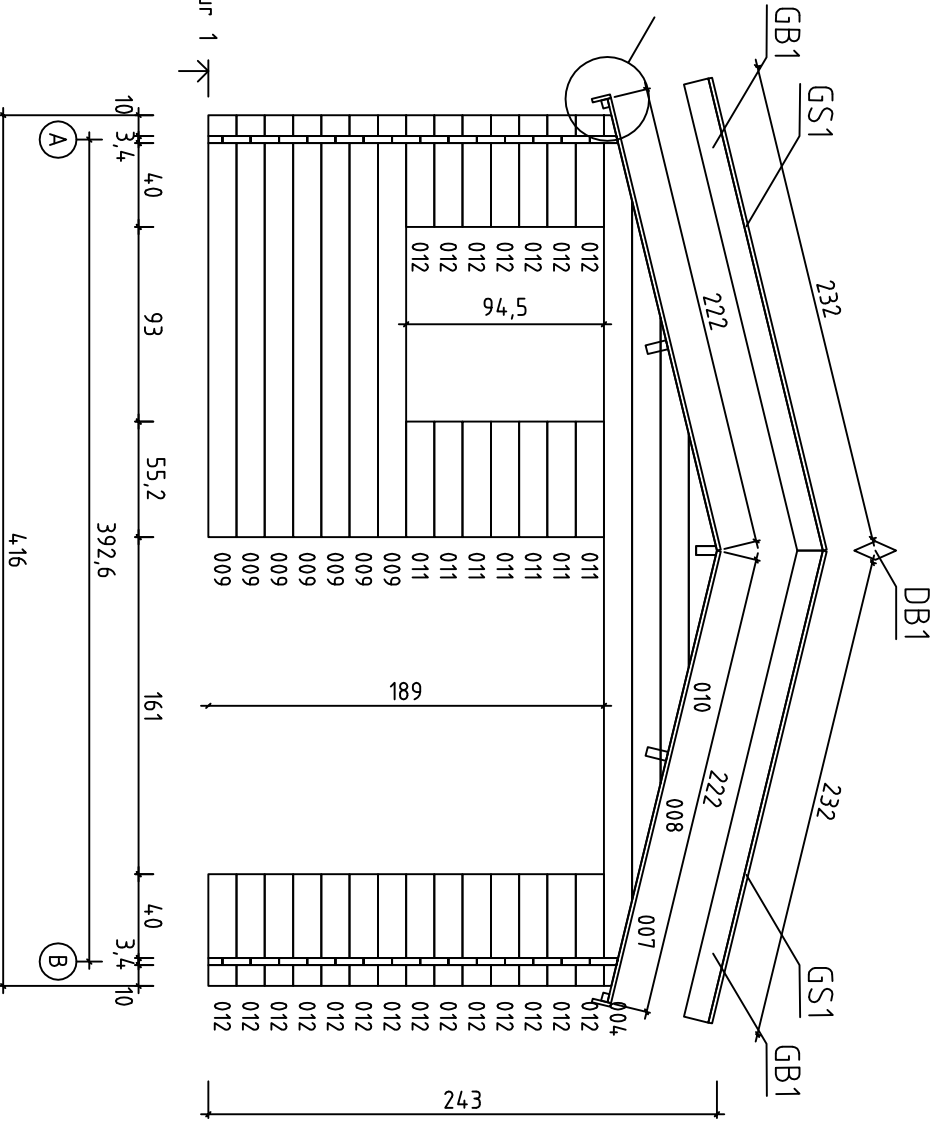



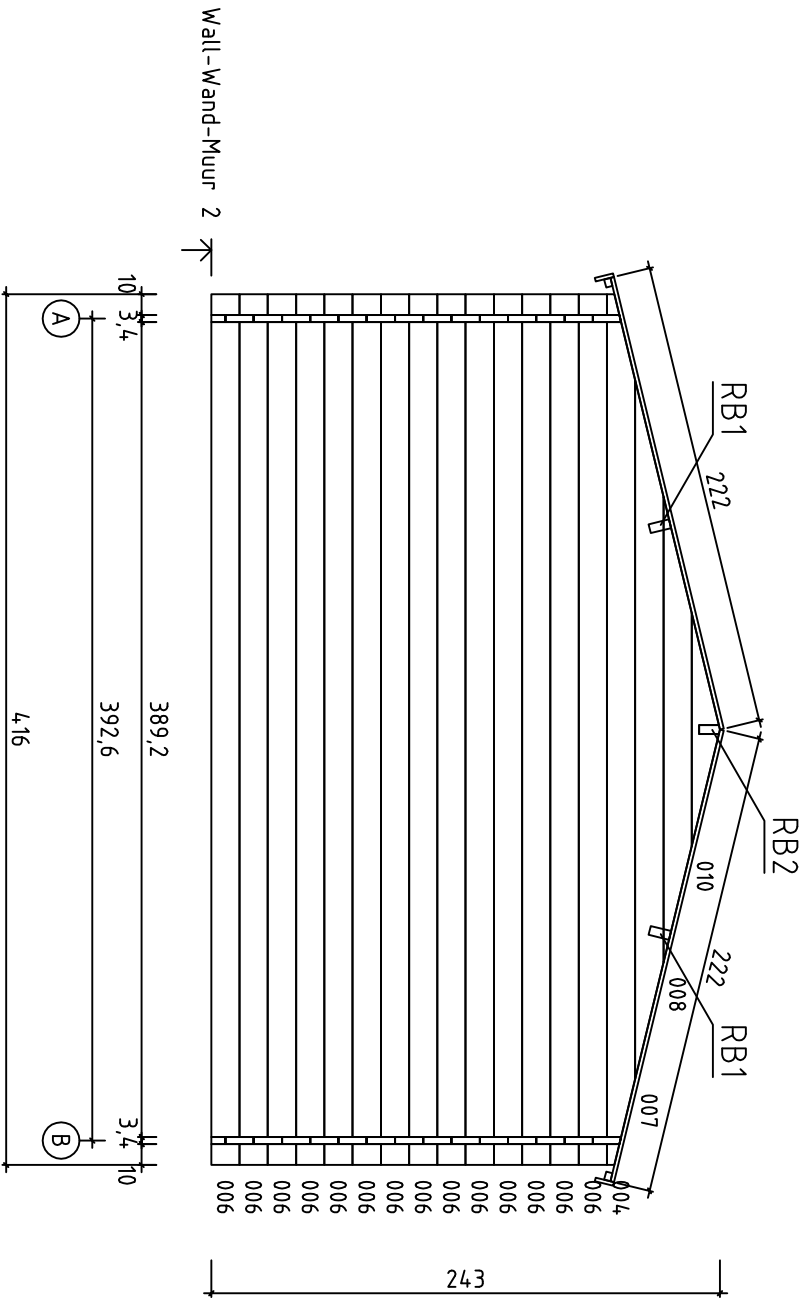





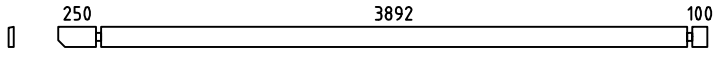
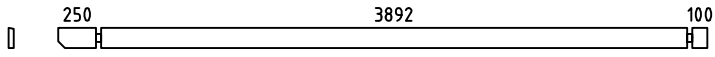
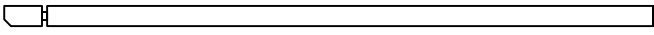
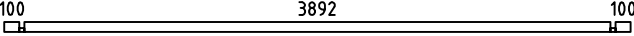
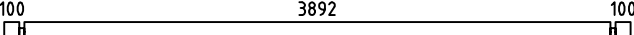
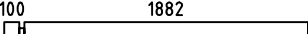



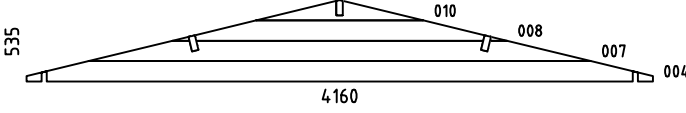
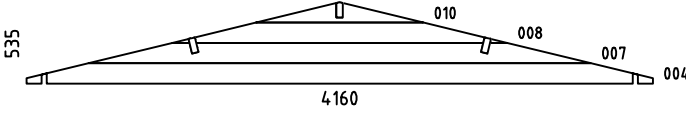
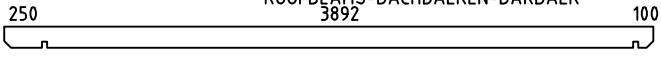
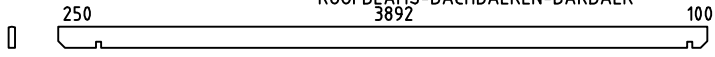

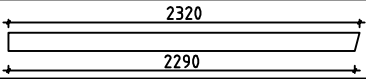
House	Hugin-34	Sheet	5
Drawing	WALL-WAND-MUUR 1	Scale	1:35
Material	3,4x13,5	Date	24.10.2019
Drawer	K.K.	File	Hugin-34.dwg



Wall-Wand-Muur 2

House	Hugin-34	Sheet	6
Drawing	WALL-WAND-MUUR 2	Scale	1:35
Material	3,4x13,5	Date	24.10.2019
Drawer	K.K.	File	Hugin-34.dwg

Pos	Specification-Bestimmung-Omschrijving Hugin-34	Pcs	Profile (mm)	L (mm)		
001	 250 3892 100	1	34x135	4310		
002	 250 3892 100	1	34x135	4310		
003	SPARE BEAM-ERZATZBOHLE-VOORRAADPLANK 	1	34x135	4310		
005	 100 3892 100	2	34x68	4160		
006	 100 3892 100	40	34x135	4160		
009	 100 1882	7	34x135	2016		
011		7	34x135	552		
012	 400 100	21	34x135	534		
HB	HIT BLOCK-SCHLAGHÖLZER-BLAZENPLANK 	2	34x135	300		
W1-1	 535 010 008 007 004 4160	1	34x535	4160		
W2-1	 535 010 008 007 004 4160	1	34x535	4160		
RB1	ROOFBEAMS-DACHBALKEN-DAKBALK  250 3892 100	2	43x140	4310		
RB2	ROOFBEAMS-DACHBALKEN-DAKBALK  250 3892 100	1	43x140	4310		
R1	ROOFBOARD-DACHBRETT-DAKPLANK  or-oder-of	99+1 76+1	18x88 18x114	2220		
GB1	GABLE BOARD-GIEBELBLENDE-GEVELPLANK  2320 2290	4	18x120	2320		
GS1	ROOF FELT FILLET-GIEBELLEISTE-GEVELLIJST 	4	18x70	2320		
EB1	EAVE BOARD-TRAUFBRETT-AFDEKPLANK 	2	18x90	4310		
ES1	EAVE SLAT-TRAUFFENLEISTE-AFDEKLIJST 	4	30x40	2155		
DB1	DIAMOND-RAUTE-DIAMANT 	2	18x90	200		
SS1	STORM SLAT-STURMLEISTE-STORMLIJST 	4	18x35	1900		
	SCREWS-SCHRAUBEN-SCHROEF FOR-FÜR-VOOR SS1 	12	φ6.0	50		
	WASHER-SCHEIBE-SCHIJF FOR-FÜR-VOOR SS1 	12	φ6.0	18		
Kood	Hugin-34	Materjal	File	Hugin-34.dwg	Leht	7

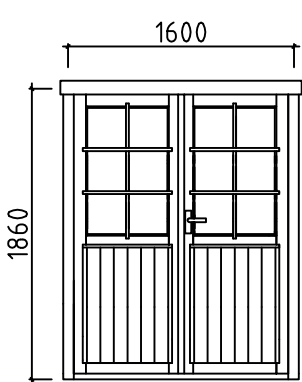
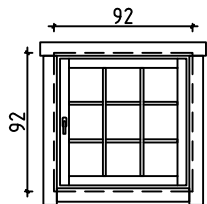
Pos	Specification-Bestimmung-Omschrijving Hugin-34	Pcs	Profile (mm)	L (mm)
	<p>DOUBLEDOOR-DOPPELTÜR-DUBBELE DEUR (right-rechts-Droit) AST_PL</p>  <p>1600</p> <p>1860</p> <p>WINDOW-FENSTER-Fenêtre 1 pcs-st-unt (right-rechts-Droit)</p>  <p>92</p> <p>92</p> <p>AST_KP</p>	<p>P</p> <p>1</p> <p>1</p> <p>1</p> <p>1</p> <p>6</p> <p>2</p> <p>P</p> <p>1</p> <p>1</p>	<p>1600</p> <p>920</p>	<p>1860</p> <p>920</p>
Kood	Hugin-34	Materjal	File	8

Kood Hugin-34

Materjal

File Hugin-34.dwg

Leht 8