

Hytte : ELDBJØRG

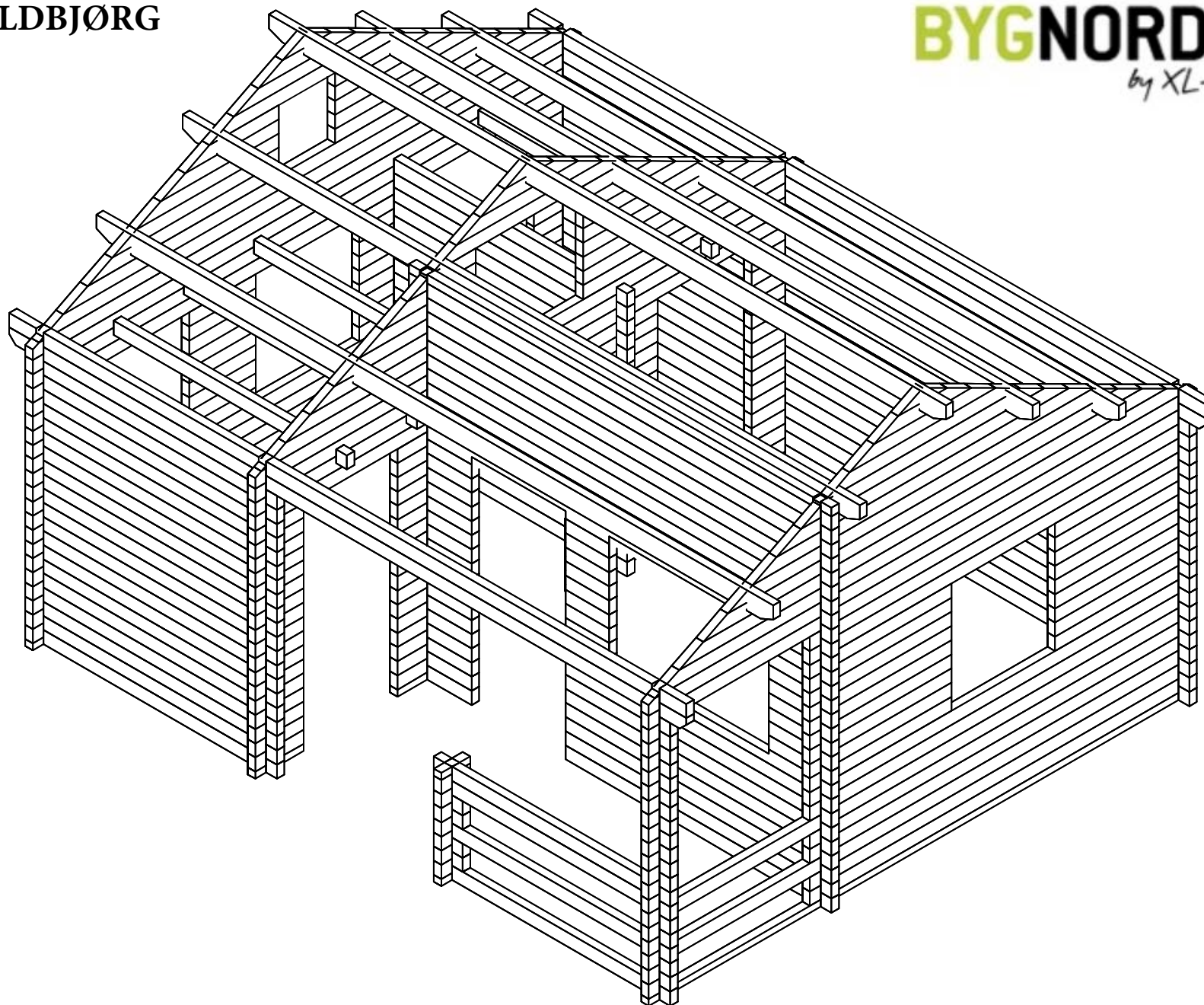

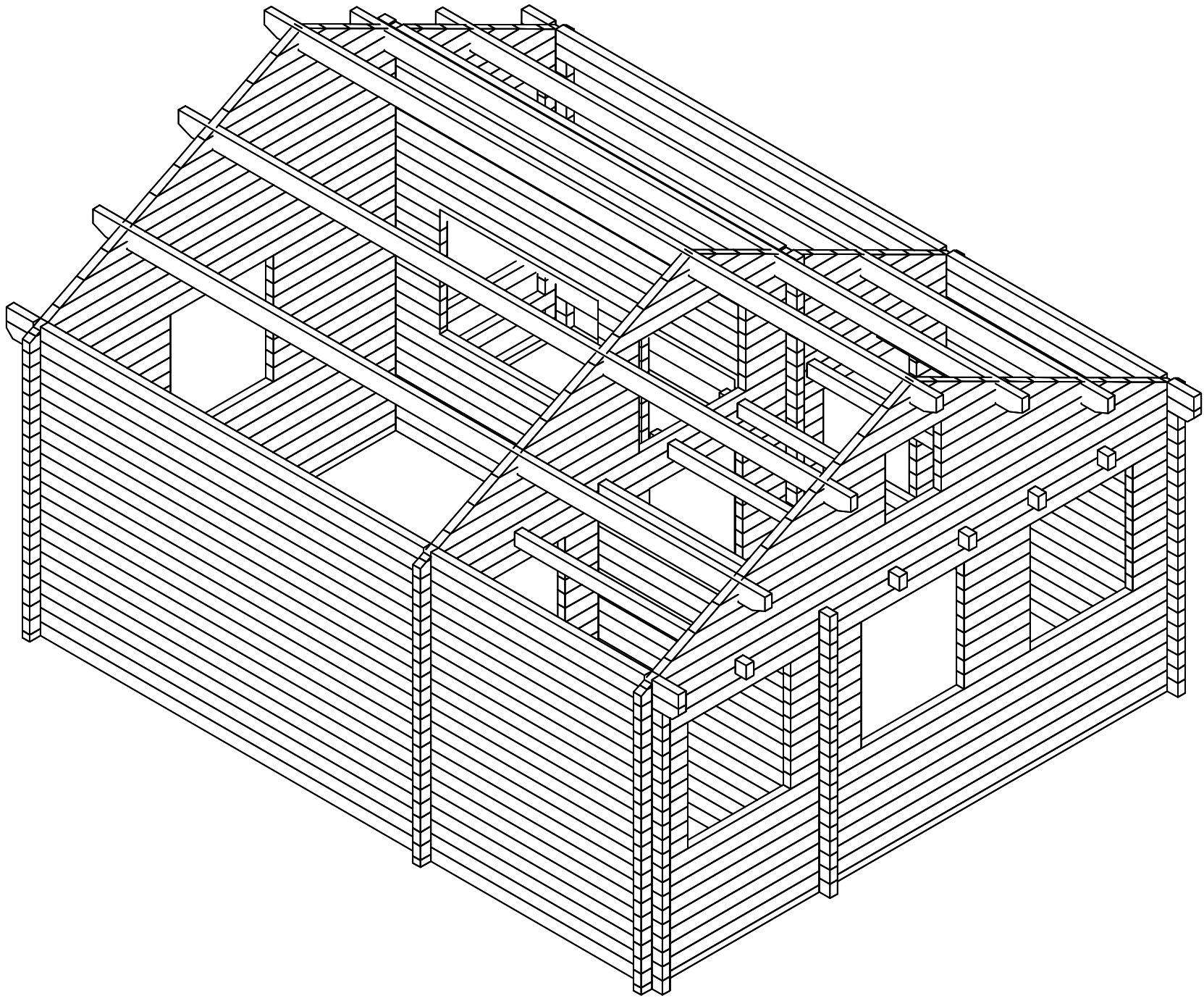

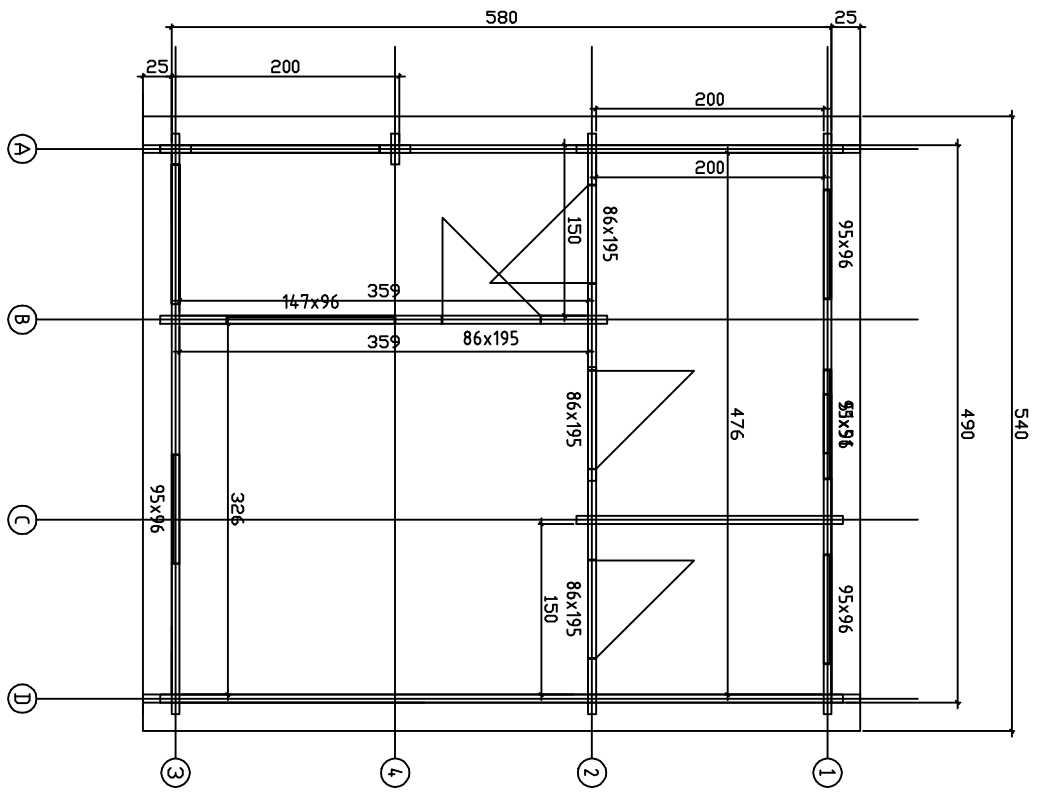



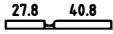
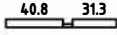

BYGNORDIC
by XL-BYG

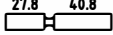
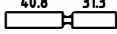

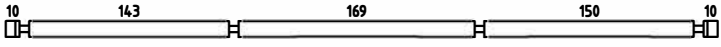
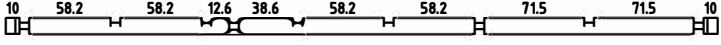
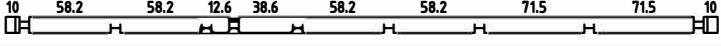
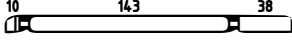
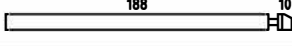
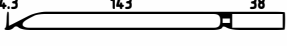
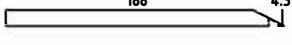
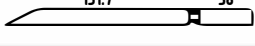

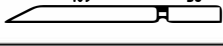

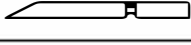
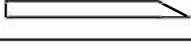

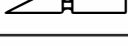
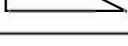





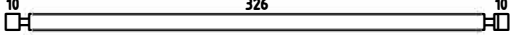

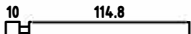
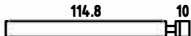







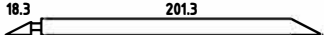

Pos	Drawing ELDBJØRG	Pcs	Profile (cm)	Length (cm)
001		1	7x5.7	510
002		9	7x11.4	510
003		9	7x11.4	49.1
004		9	7x11.4	61.8
005		9	7x11.4	66.1
006		9	7x11.4	43.8
007		1	7x11.4	510
008		1	7x11.4	510
009		1	7x11.4	510
010		1	7x11.4	498.7
011		1	7x11.4	453.3
012		1	7x11.4	177.8
013		1	7x11.4	177.8
014		1	7x11.4	155.1
015		1	7x11.4	155.1
016		1	7x11.4	132.5
017		1	7x11.4	132.5
018		1	7x11.4	109.8
019		1	7x11.4	109.8
020		1	7x11.4	87.1
021		1	7x11.4	87.1
022		1	7x11.4	181.3
023		3	7x11.4	136
024		3	7x11.4	90.7
025		3	7x11.4	45.3
Mater jal		File ELDBjØRG 70.dwg		Leht 1/4

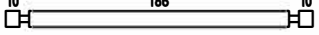
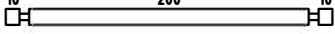
Pos	ELDBJØRG Drawing	Pcs	Profile (cm)	Length (cm)
026		1	7x5.7	44.8
027		1	7x5.7	75.6
028		1	7x5.7	79.1
029		1	7x5.7	48.3
030		17	7x11.4	44.8
031		17	7x11.4	75.6
032		17	7x11.4	79.1
033		17	7x11.4	48.3
034		1	7x11.4	510
035		1	7x11.4	510
036		1	7x11.4	510
037		1	7x11.4	205
038		1	7x11.4	205
039		1	7x11.4	199.3
040		1	7x11.4	199.3
041		1	7x11.4	176.7
042		1	7x11.4	176.7
043		1	7x11.4	154
044		1	7x11.4	154
045		1	7x11.4	131.3
046		1	7x11.4	131.3
047		1	7x11.4	108.7
048		1	7x11.4	108.7
049		1	7x11.4	86
050		1	7x11.4	86
Mater jal		File ELDBJØRG 70.dwg	Leht 2/4	

Pos	Drawing	Pcs	Profile (cm)	Length (cm)
051		1	7x11.4	63.3
052		1	7x11.4	63.3
053		1	7x11.4	178.7
054		1	7x5.7	510
055		17	7x11.4	27
056		8	7x11.4	360
057		3	7x11.4	510
058		9	7x11.4	131.8
059		9	7x11.4	131.8
060		1	7x11.4	510
061		1	7x11.4	498.7
062		1	7x11.4	453.3
063		1	7x11.4	408
064		1	7x11.4	362.7
065		1	7x11.4	317.3
066		1	7x11.4	272
067		1	7x11.4	226.7
068		1	7x11.4	178.7
069		1	7x5.7	27
070		23	7x11.4	27
071		1	7x5.7	27
072		4	7x11.4	220
073		40	7x11.4	234
074		4	7x11.4	27
075		2	7x11.4	630
Mater jal		File ELDBJØRG 70.dwg		Leht 3/4

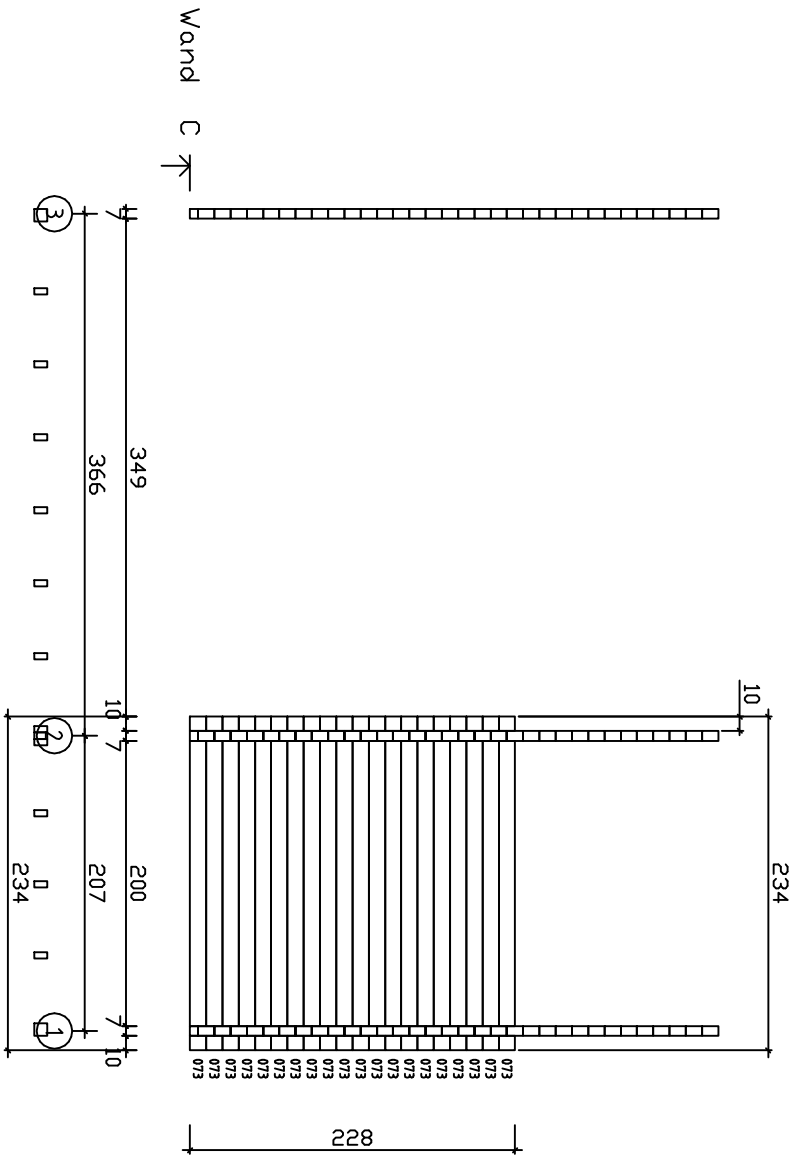

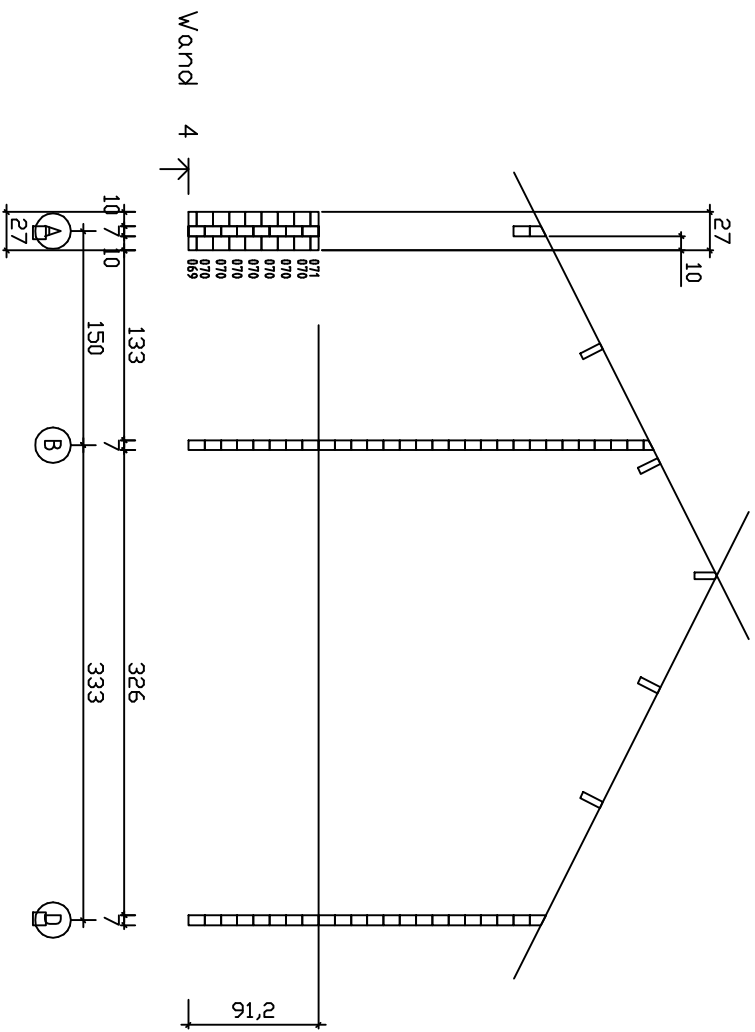

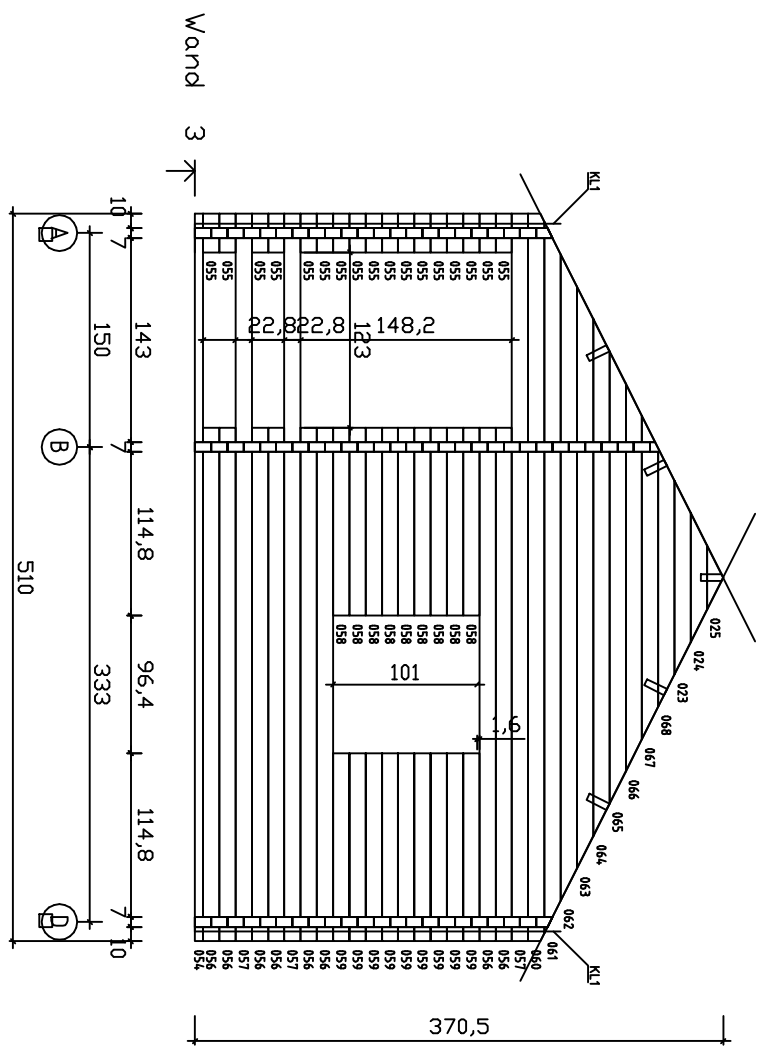

Wand 3

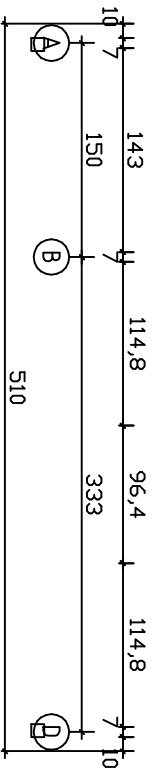

370,5

025
024
023
068
067
066
065
064
063
062
061
060
059
058
057
056
055
054
053
052
051
050
049
048
047
046
045
044
043
042
041
040
039
038
037
036
035
034
033
032
031
030
029
028
027
026
025
024
023
022
021
020
019
018
017
016
015
014
013
012
011
010
009
008
007
006
005
004
003
002
001

MATERJALBESCHREIBUNG		ELDBJØRG		
DETAIL	B mm	H mm	L mm	ST.
WALLBEAMS	70	114		370
FLOOR BEAM	90	90	5800	2
	90	90	4720	2
	45	90	4720	12
FLOORBOARDS	28	112	1990	43
	28	112	3580	30
	21	112	4750	18
TERRACE BOARD	28	120	3580	13
FLOOR PERIPHERY	20	45		
ROOF BOARD	18	112	3030	114
ROOF PERIPHERY	18	95	3150	4
ROOF PERIPHERY	26	32	3150	4
ROOF PERIPHERY 27	18	140	3130	4
	18	95	3130	4
ROOF BEAM	64	164	6300	5
HAND	18	95	1230	1
	18	95	1930	1
LADDER		700	2510	1
DOOR	860	1950	ISO R	2
DOOR	860	1950	WOOD R	2
WINDOW	950	960	iso	4
WINDOW	510	510	iso	1
WINDOW	1470	960	iso	1
RHOMB				2
THREADED ROD		10	2000	8
CONNECTION NUT				6
NUT				12