

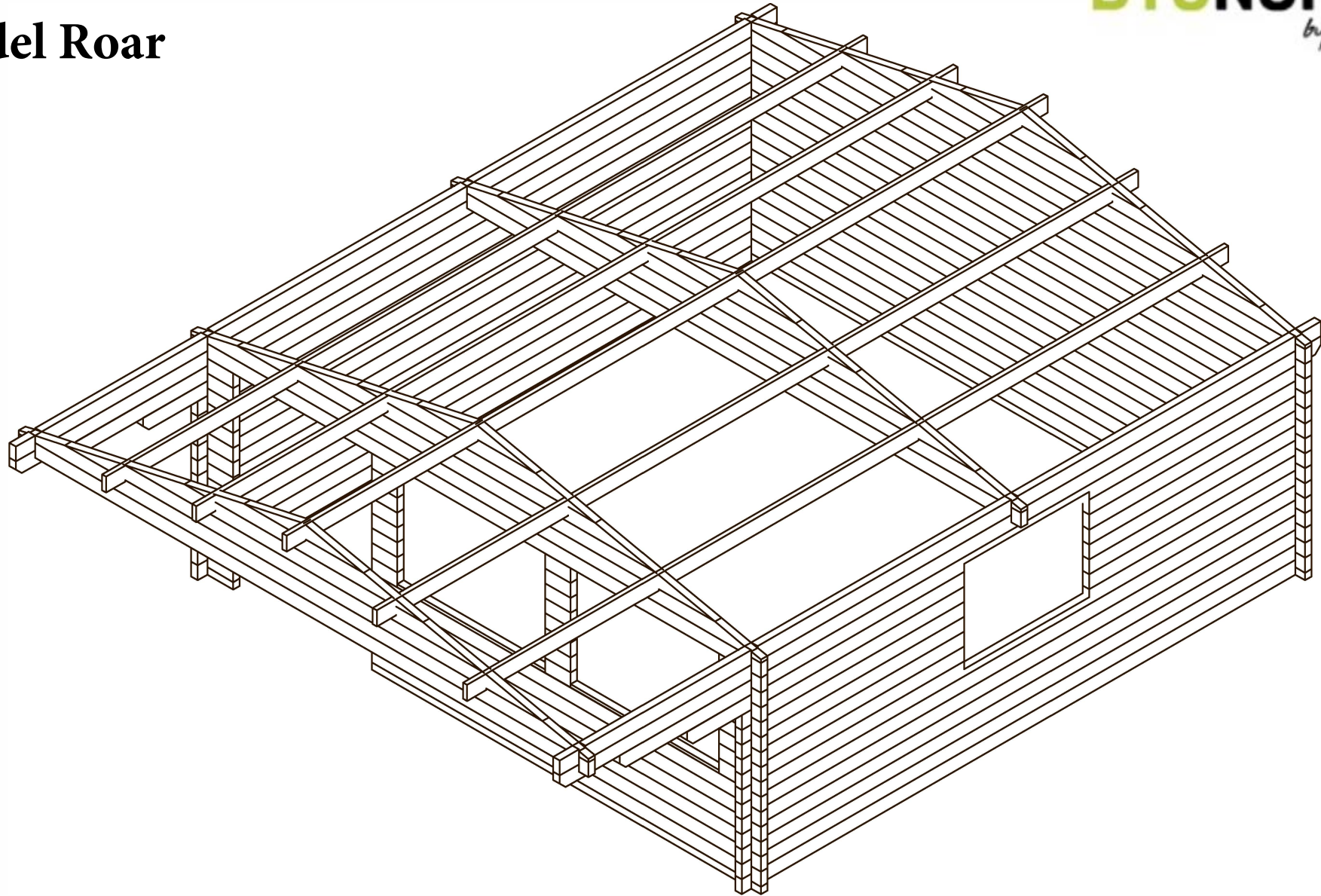

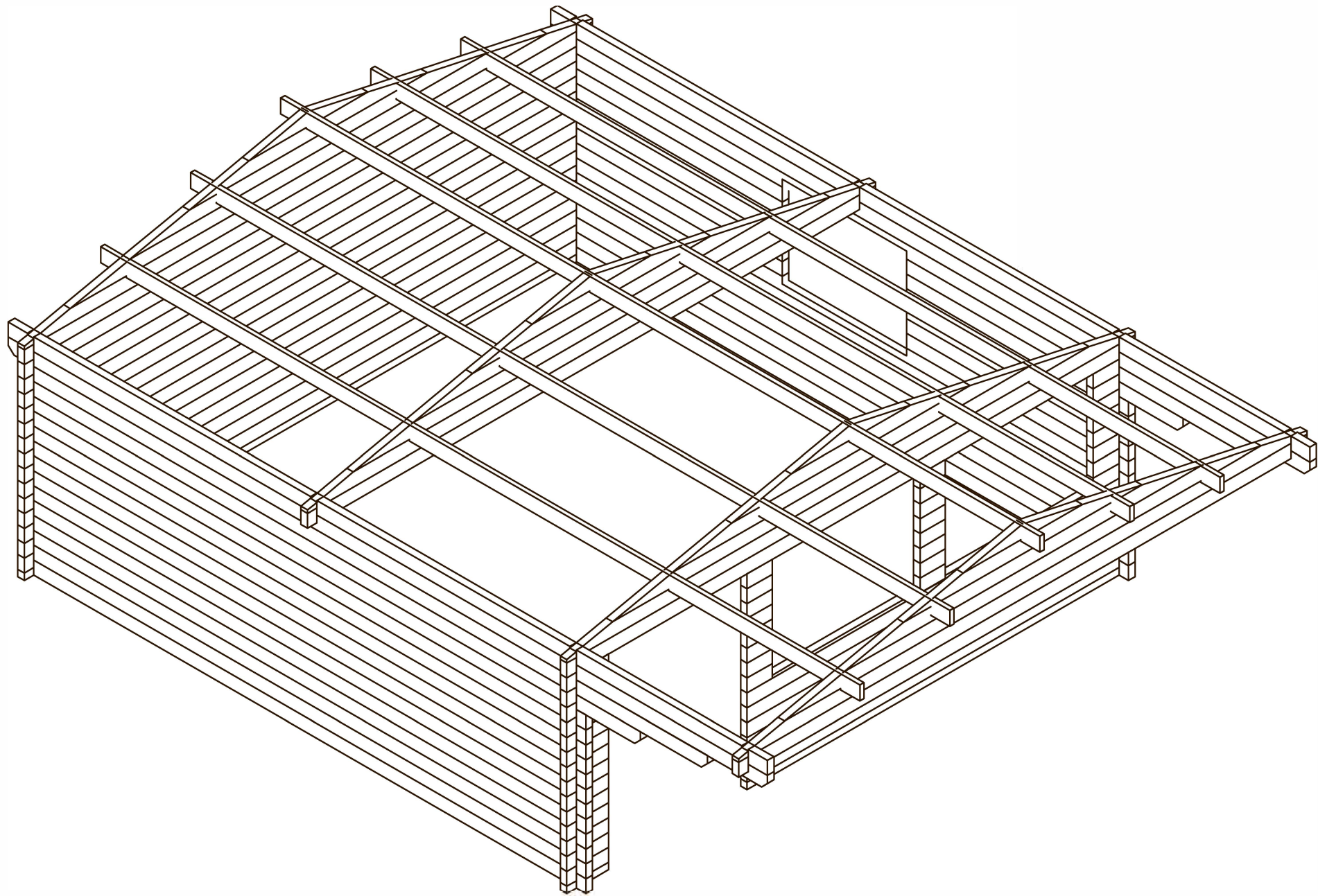

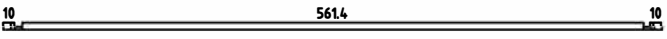

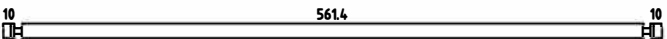

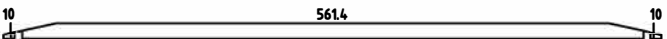



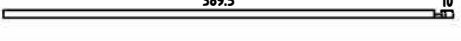

# Model Roar

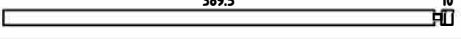
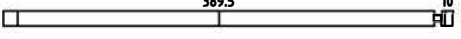
**BYGNORDIC**  
by XL-BYG

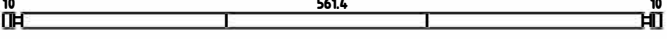
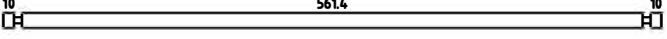
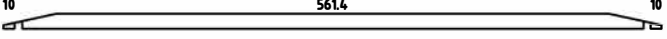
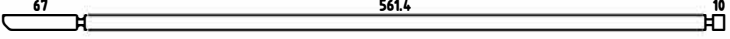

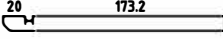

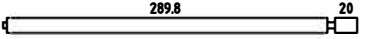
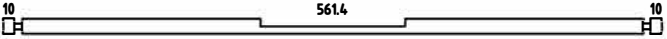
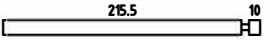

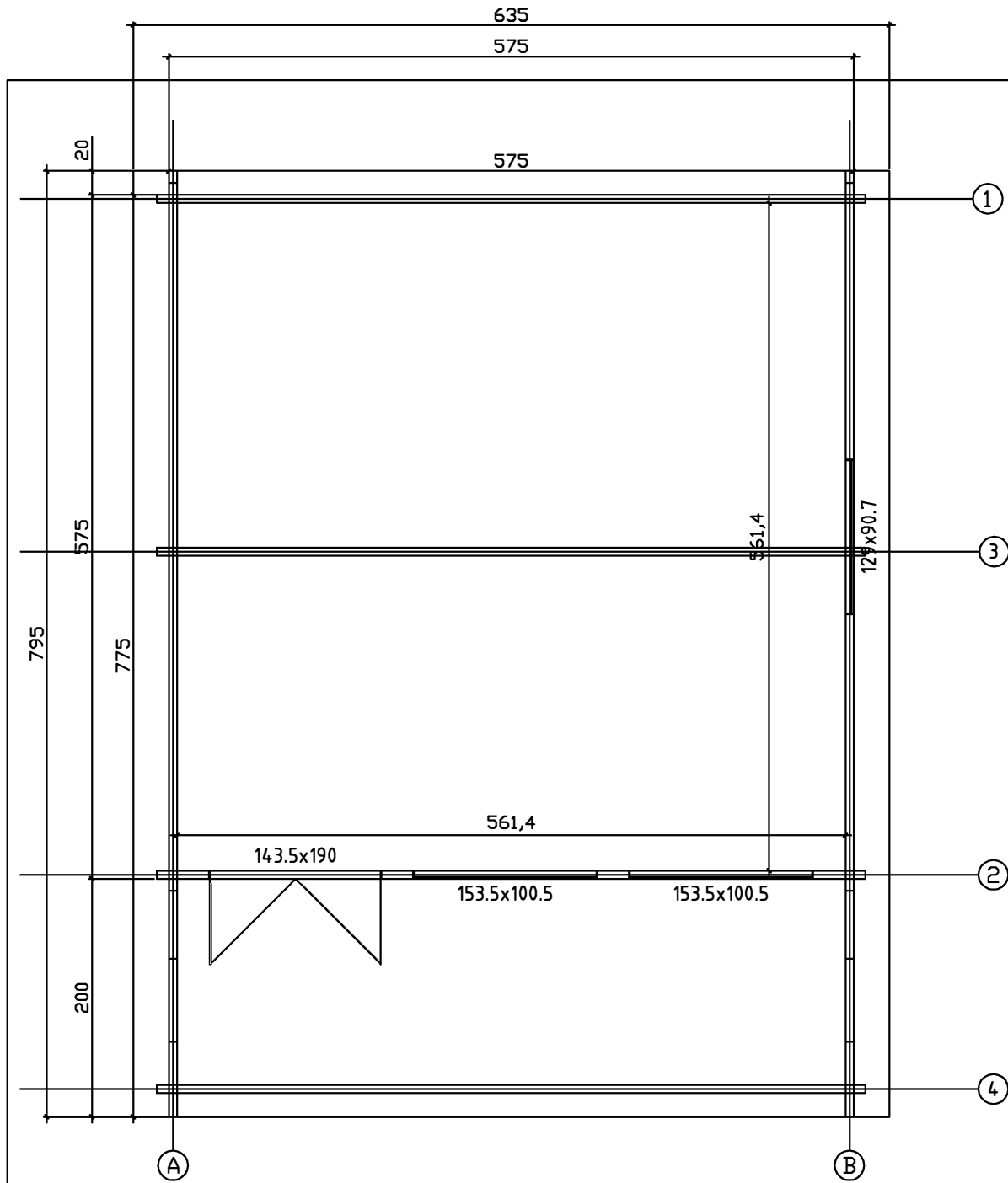

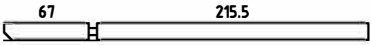

Pos	Drawing Roar	Pcs	Profile (cm)	Length (cm)
001		1	6.8x6.8	595
002		15	6.8x13.5	595
003		2	6.8x13.5	595
004		4	6.8x13.5	499
005		4	6.8x13.5	374.3
006		4	6.8x13.5	249.5
007		4	6.8x13.5	124.8
008		1	6.8x6.8	43.8
009		1	6.8x6.8	406.3
010		22	6.8x13.5	43.8
011		5	6.8x13.5	406.3
012		1	6.8x13.5	406.3
013		8	6.8x13.5	26.3
014		8	6.8x13.5	26.3
015		1	6.8x13.5	595
016		20	6.8x13.5	595
017		2	6.8x13.5	595
018		1	6.8x13.5	652
019		1	6.8x13.5	722
020		2	6.8x13.5	203.4
021		2	6.8x13.5	591.6
022		1	6.8x13.5	475
023		1	6.8x13.5	320
024		1	6.8x13.5	595
025		11	6.8x13.5	232.3
Materjal			Leht 1/2	

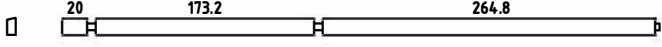
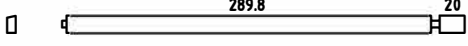

Kood	Roar	Leht
Joonis	Plaan	Mootkava 1:50
Materjal	68x135	Kuup. 30.01.2014
Joonestaj	Priit Aja	

Pos	Drawing Roar	Pcs	Profile (cm)	Length (cm)
026		1	6.8x13.5	289.3
027		1	6.8x13.5	722
028		1	6.8x13.5	475
029		1	6.8x13.5	320
030		2	6.8x2.9	154.9
PR1		4	4.3x14.5	795
PR2		1	4.3x14.5	795
	WINDOW 153.5x100.5	2		
	WINDOW 129x90.7	1		
	DOOR 143.5x190	1		

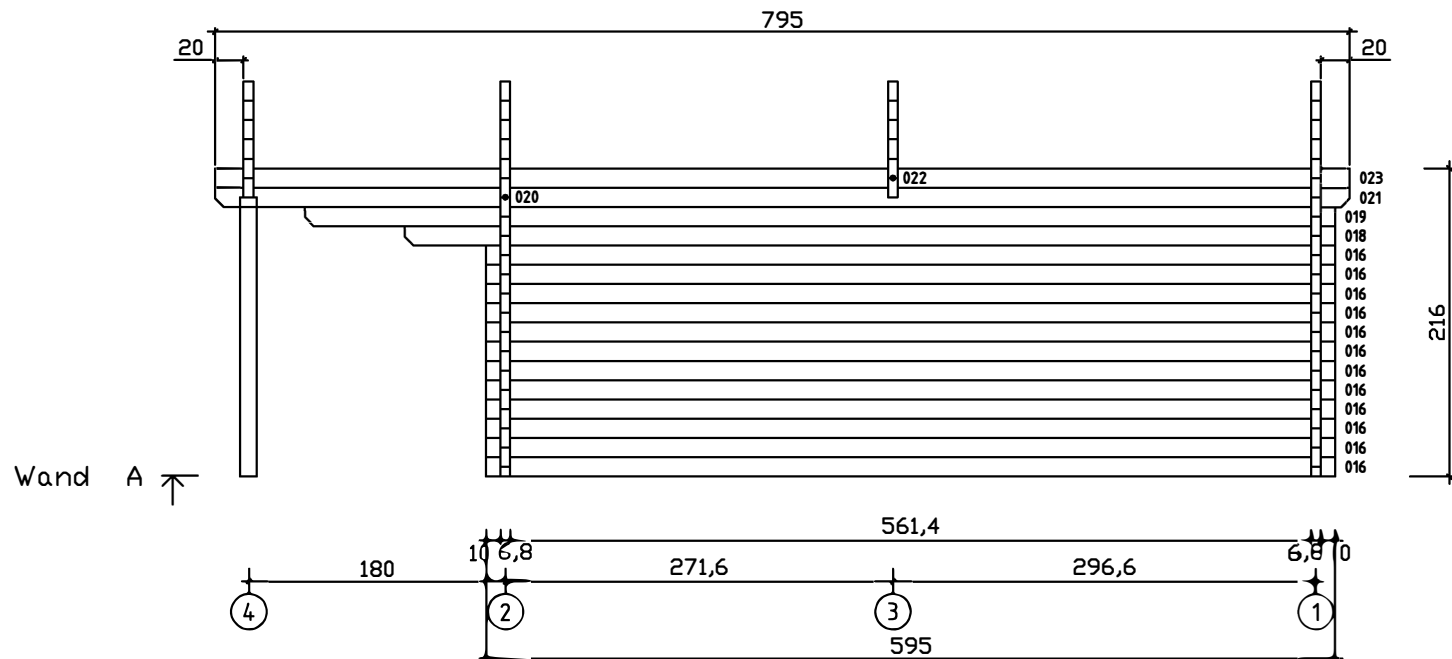

Kood	Roar	Leht	2
Joonis	Wand A	Mootkava	1:50
Materjal	6.8x13.5	Kuup.	30.01.2014
Joonestas	Priit Aja		

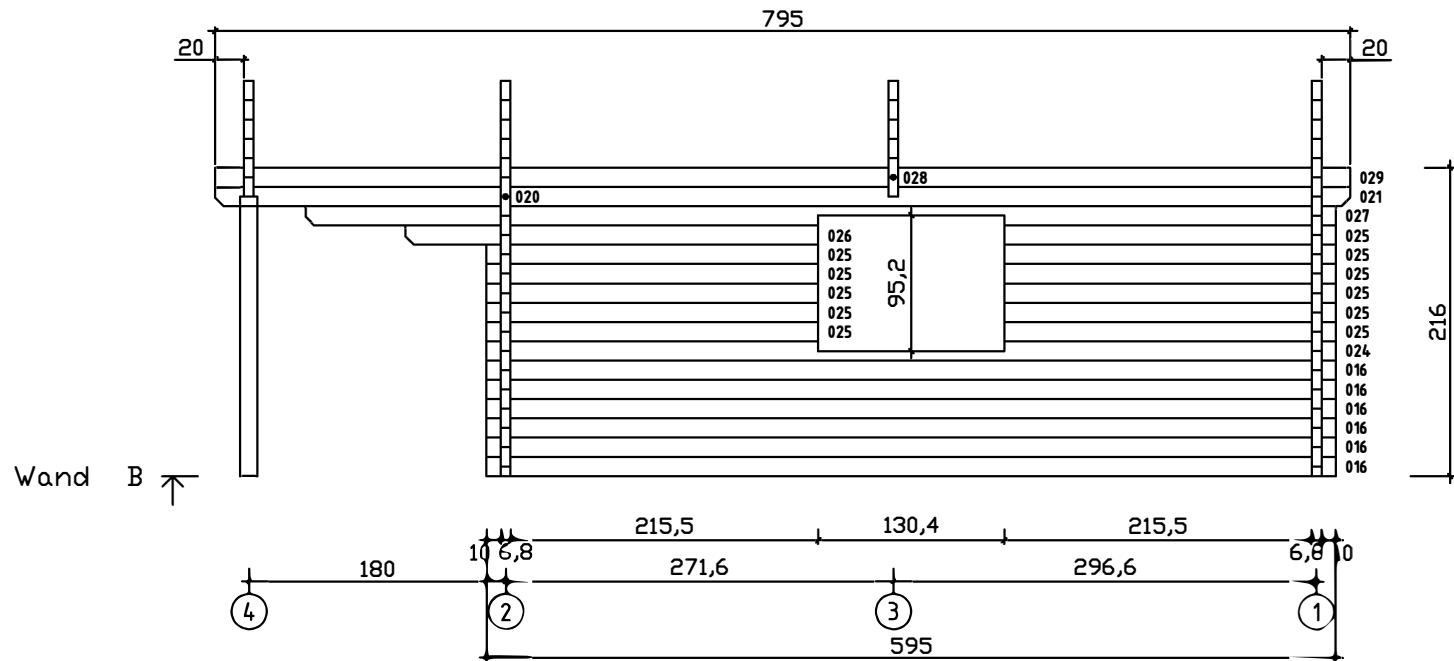

Kood	Roar	Leht	3
Joonis	Wand B	Mootkava	1:50
Materjal	6.8x13.5	Kuup.	30.01.2014
Joonestas	Priit Aja	File	







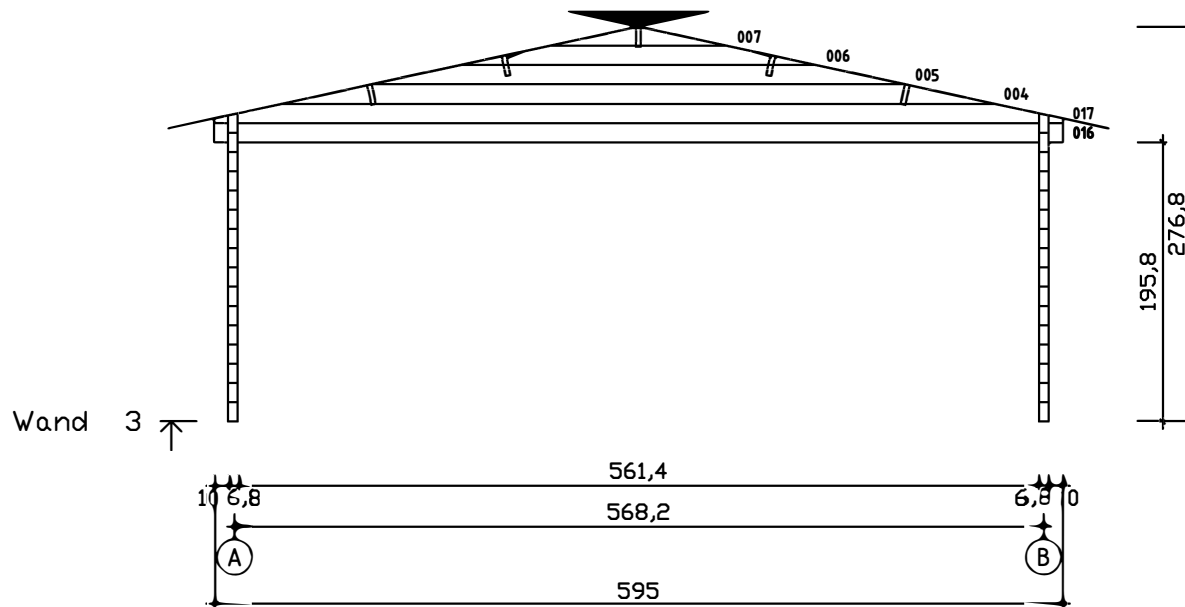

Kood	Roar	Leht	6
Joonis	Wand 3	Mootkava	1:50
Materjal	6,8x13,5	Kuup.	30.01.2014
Joonestas	Priit Aja		

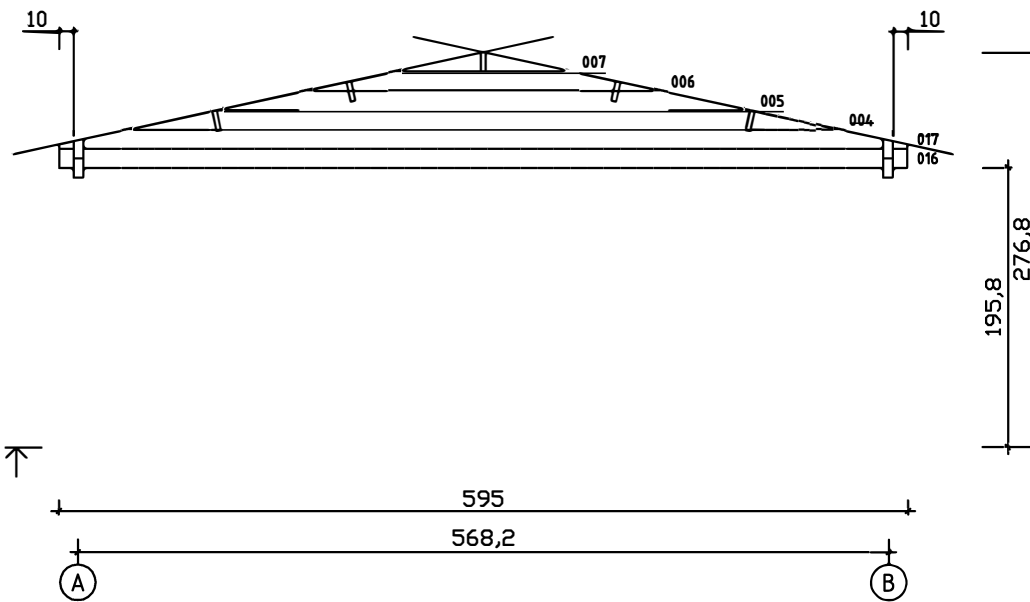

Kood	Roar	Leht	7
Joonis	Wand 4	Mootkava	1:50
Materjal	6,8x13,5	Kuup.	30.01.2014
Joonestaja	Priit Aja		

MATERIAL		Roar		
DETAIL	B mm	H mm	L mm	ST.
WALLBEAMS	68	135		129
ROOF BOARDS	18	112	3145	142
ROOF PERIPHERY	18	90	3975	4
ROOF BEAM	43	145	7950	5
POST	90	90	1970	2
ROOF PERIPHERY	26	32	3975	4
ROOF PERIPHERY 12°	18	145	3245	4
	18	90	3245	4
DOOR FULL GLASS 1435x1900			ISO	1
WINDOW 1535x1005			ISO	2
WINDOW 1290x907			ISO	1
BOLT DOWN POST FITTING				2

MATERIAL		Roar		
DETAIL	B mm	H mm	L mm	ST.
WALLBEAMS	68	135		129
ROOF BOARDS	18	112	3145	142
ROOF PERIPHERY	18	90	3975	4
ROOF BEAM	43	145	7950	5
POST	90	90	1970	2
ROOF PERIPHERY	26	32	3975	4
ROOF PERIPHERY 12°	18	145	3245	4
	18	90	3245	4
DOOR FULL GLASS 1435x1900			ISO	1
WINDOW 1535x1005			ISO	2
WINDOW 1290x907			ISO	1
BOLT DOWN POST FITTING				2