



**38, 76 AND 190 SERIES  
CEDAR TEXTURE, BRUSHED SMOOTH,  
OR PEBBLED STUCCO PRIMED PANEL SIDING**  
(including SilverTech® & SmartFinish®)

LOUISIANA-PACIFIC CORPORATION PERIODICALLY UPDATES AND REVISES ITS PRODUCT INFORMATION AND APPLICATION, CARE, AND MAINTENANCE INSTRUCTIONS. WARRANTY REMEDIES ARE NOT AVAILABLE IF THESE INSTRUCTIONS ARE NOT FOLLOWED. THE INFORMATION IN THIS DOCUMENT IS SUBJECT TO CHANGE WITHOUT NOTICE.

FIND ALL LP® SMARTSIDE® PRODUCT LITERATURE AT [LPCORP.COM/SMARTSIDE](http://LPCORP.COM/SMARTSIDE)

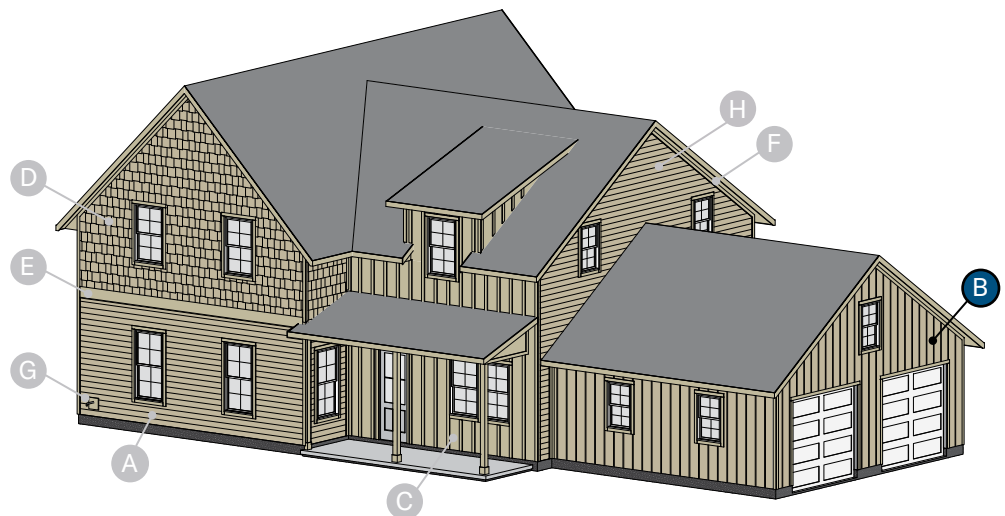
LP® SmartSide® Trim & Siding is covered under the LP® SmartSide® Prorated 50-Year Limited Warranty. Refer to the warranty, which is available online, for complete terms and conditions. Product must be transported, stored, handled, installed, finished, and maintained in accordance with all published application, finishing, care, and maintenance instructions, technical notes, and bulletins (collectively, "Instructions") in effect at the time of installation.

Failure to follow such Instructions will make the limited warranty inapplicable as to the products affected by such failure. No modification or exception to these Instructions and no non-published recommendations are valid unless issued in writing on a project-specific basis by LP's Sr. Director of Technology prior to application. Always check and comply with local building codes. Even where these instructions approve installation over certain substrates or incorporate requirements of building codes, LP's liability for the performance of the product is limited as expressly provided in the Limited Warranty.

**⚠ WARNING: Drilling, sawing, sanding or machining wood products can expose you to wood dust, a substance known to the State of California to cause cancer. Avoid inhaling wood dust or use a dust mask or other safeguards for personal protection. For more information go to [P65Warnings.ca.gov/wood-dust](http://P65Warnings.ca.gov/wood-dust).**

## PRODUCT LEGEND

- A** LP® SmartSide® Lap Siding
- B** LP® SmartSide® Panel Siding
- C** LP® SmartSide® Vertical Siding
- D** LP® SmartSide® Cedar Shake
- E** LP® SmartSide® Trim & Fascia
- F** LP® SmartSide® Soffit
- G** LP® SmartSide® Accessories
- H** LP® SmartSide® Nickel Gap Siding



## GENERAL INFORMATION

### HANDLING

- Handle siding with care during storage, temporary placement, and application.
  - Additional care is required to ensure shiplap edges are not damaged.

### STORAGE

- Store siding:
  - Under a roof or waterproof covering (like unit cover/bonnet).
  - Off the ground, on a flat-drained surface using supports that provide a min. 1-1/2 inch (38 mm) clearance from surface.
    - This includes when staging siding around jobsite during installation.
- LP is not responsible for damage due to improper handling and storage of the siding.



### BEFORE YOU BEGIN

- At the time of manufacture, siding meets or exceeds the performance standards set forth in ICC-ES AC321 and has achieved recognition under PR-N124, ESR-1301, CCMC 11826-L, FL#9109 and HUD-MR-1318d. For copies of product approvals go online at <https://lpcorp.com/product-literature> or call LP Customer Support at 888-820-0325.

## GENERAL INFORMATION (CONT'D.)

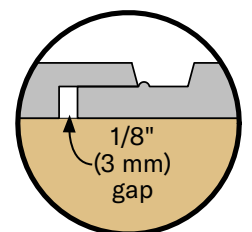
- Where siding butts window trim, door casings, butt joints, etc. leave a 3/16 inch (5 mm) gap and seal.
  - A larger gap is required when siding is adjacent to stucco, brick, cultured stone, mortar, etc. (Figure 6b, 6c, 6d)
- Panel siding with SilverTech® or SmartFinish® is developed specifically for sheds and other accessory structures where the interior wall cavities are without insulation or wall finishes.
  - For non-residential use only.
- **Shiplap edge panel siding is limited to vertical applications.** (Figure 2a, 2b)
  - Exception: Panel siding installed in metal trim systems as outlined in [Technical Note #015](#).
- No Groove square edge panel siding may be installed vertically or horizontally.
  - Provide a min. 3/8 inch (10 mm) gap and Z-flashing at horizontal seam. (Figure 5c)
- Siding applied adjacent to surfaces such as porches, patios, balconies, or walking surfaces (including porch columns) must have a clearance of at least 1 inch (25 mm) above horizontal surface.
  - Clearance may be reduced to 3/8 inch (10 mm) for:
    - Porches, patios, balconies, or walking surfaces that slope away from the structure or the surface provides gaps that allow water to flow through so that it cannot accumulate, and is covered by a roof, not an eave or overhang; or
    - Porch columns with walking surfaces that slope away from the structure or the surface provides gaps that allow water to flow through so that it cannot accumulate.
- All wood substrate directly exposed to the weather must be sealed to prevent moisture intrusion and water build up.
  - Seal ALL exposed cuts of siding and trim. Field spray applied coatings on cuts are not recommended.
  - Sealing can be accomplished by applying a paint or sealant according to the manufacturer's requirements.
- See **Alternate Fastening Options** on page 8 for attaching siding to wood structural panel (WSP) sheathing or SIP assemblies.
- LP does not recommend panel siding for use over furring strips/strapping or in ICF assemblies. If used, LP will **NOT** warrant for Buckling.
  - [Exception: Panel siding may be applied to furring in Canada.]
  - [See **Alternate Fastening Options** starting on page 8 for attaching panel cladding over furring in Canada.]
- Siding may be applied over an entangled mat. Ensure mat is rigid enough to receive siding to avoid a wavy or inconsistent appearance.

## TRIM

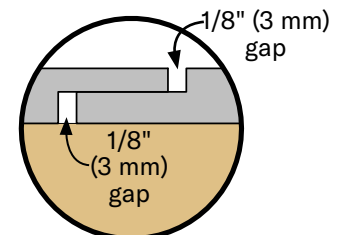
- Use LP® SmartSide® 540 Series or 440 Series trim so the panel siding does not extend beyond the face of the trim.
  - 190 Series trim may be used when applying trim on top of siding.
- See page 11 for PREFERRED and ALTERNATE details for Outside and Inside Corner Trim. (Figure 11d, 11e, 11f, 11g)

## PANEL EDGE PROFILES

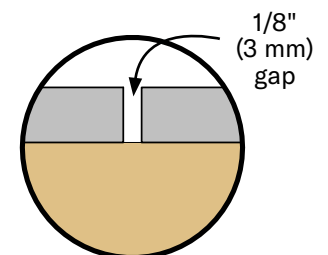
- Panel siding products are available in 3 edge profiles:
  1. Shiplap edge with alignment bead profile applies to the following siding products (Figure 2a):
    - 4 inch (102 mm) o.c. and 8 inch (203 mm) o.c. grooved panel
  2. Shiplap edge without alignment bead applies to the following siding product (Figure 2b):
    - No groove panel
  3. Square edge profile applies to the following siding products (Figure 2c):
    - No groove panel
    - Dual-use panel siding/soffit:
      - PID# 41044** - 38 Series Cedar Texture 4' x 8' (1 219 mm x 2 438 mm)
      - PID# 46050** - Pebbled Stucco 3/8" x 4' x 10' (10 mm x 1 219 x 3 048 mm)
      - PID# 46051** - Pebbled Stucco 3/8" x 4' x 9' (10 mm x 1 219 mm x 2 743 mm)



Shiplap Edge with Alignment Bead  
Figure 2a



Shiplap Edge without Alignment Bead  
Figure 2b



Square Edge  
Figure 2c

## MOISTURE

- Moisture and vapor control are critical elements of proper housing design.
  - Check your local building code for requirements for handling moisture and water vapor in your area.
  - Do not apply engineered wood siding to a structure having excessive moisture conditions such as drying concrete, plaster, or wet blown cellulose insulation.
    - If such conditions exist, building should be well ventilated to allow to dry prior to siding application.
  - When using wet blown cellulose insulation it must not be in direct contact with the siding, and it must be allowed to dry a min. of 24 hours or longer if specified by the insulation manufacturer.
- Siding must not be installed on green or crooked studs.
  - If studs are crooked, shim to maintain siding flatness.
- Do not apply siding over rain-soaked or buckled sheathing.
- Siding must not be in direct contact with CMU, poured concrete, brick, cultured stone, stucco, mortar, etc.

## WATER-RESISTIVE BARRIER (WRB)

- A properly installed WRB is required behind siding, unless exempt by building code.
- LP assumes no liability for moisture intrusion or any other issues associated with the WRB.
- Sheds and other accessory structures where the interior wall cavities will remain permanently exposed may use LP SmartSide panel siding with SilverTech® or SmartFinish® without a WRB, if allowed by local building code.

## FLASHING

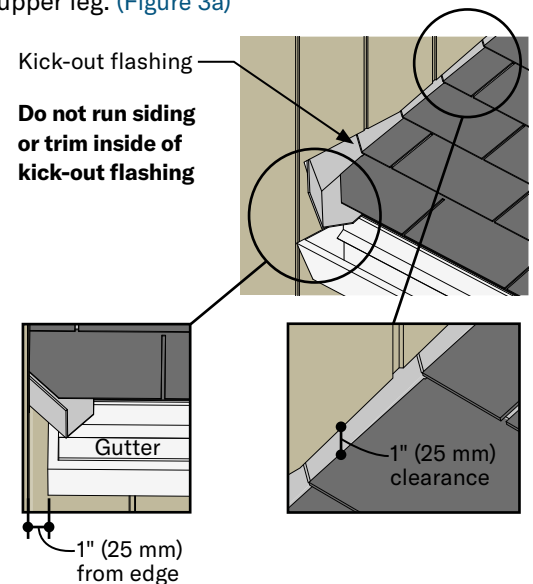
- All openings must be properly sealed or flashed in a manner that prevents moisture intrusion or buildup.
- Flashing shall be metal or another durable material that will last for not less than 50 years.
- Install step flashing at roof-to-wall intersections with a min. 4 inch (102 mm) upper leg. (Figure 3a)
- All other flashing must have a min. 4 inch (102 mm) upper leg.
  - Add 4 inch (102 mm) wide adhesive flashing when upper leg is less than 4 inches (102 mm).
- Properly integrate flashing with WRB, use flashing tape or WRB to maintain counterflashing principle.

## KICK-OUT FLASHING

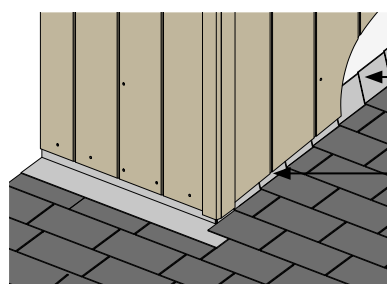
- Install kick-out flashing at roof eave-to-wall intersections to direct water into gutter.
- DO NOT extend siding or trim into kick-out flashing or gutter.**
- Maintain 1 inch (25 mm) clearance between the end of the gutter and the adjoining wall to allow for proper maintenance of siding. (Figure 3c)

## ROOF TO WALL INTERSECTION

- Maintain 1 inch (25 mm) clearance between siding and roofing, or trim and roofing. *[Min. 50 mm (2 inch) clearance at intersection with roof line must be maintained between roof surface and cladding when installing cladding in Canada in accordance with the NBC, Section 9.27.2.4.(2) or local building code requirements.]* (Figure 3a, 3b)



**Kick-out Flashing**  
Figure 3c

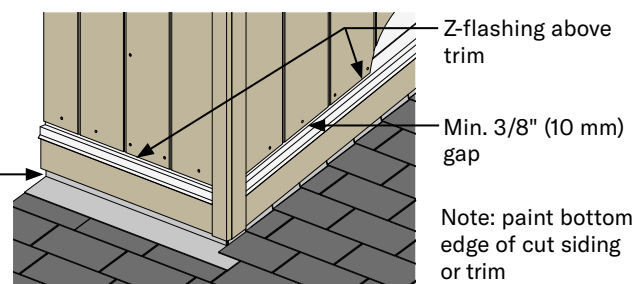


**Siding without Trim**

Figure 3a

4" (102 mm) step flashing

1" (25 mm) min. clearance from roofing *[Min. 50 mm (2") clearance from roofing]*



**Siding with Trim**

Figure 3b

Note: paint bottom edge of cut siding or trim

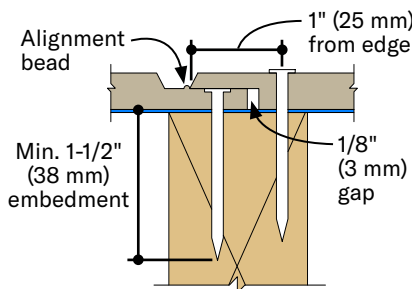
## FASTENING INSTRUCTIONS

### STUD SPACING OPTIONS

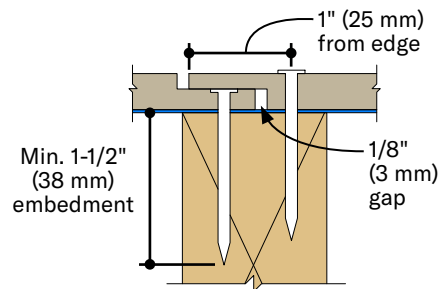
- 38 & 76 Series Panel Siding may be attached **direct to studs** spaced max. 16 inches (406 mm) o.c.
- 190 Series Panel Siding may be attached **direct to studs** spaced max. 24 inches (610 mm) o.c.
- Siding may be attached **directly to a min. 7/16 Performance Category wood structural panel (WSP) sheathing**, with studs spaced a max. 24 inches (610 mm) o.c.

### DIRECT TO STUDS APPLICATION

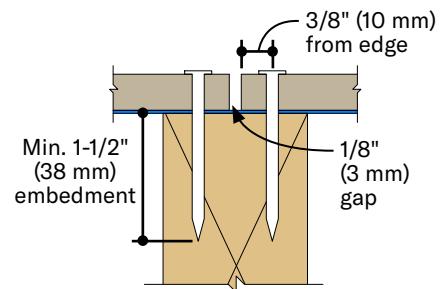
- Align the overlap edge of panel to outside edge of the alignment bead. (Figure 4a, 4d)
  - Doing so will maintain the 1/8 inch (3 mm) expansion gap on the back side of the panel seam.
- Penetrate studs or combination of WSP sheathing and studs a min. of 1-1/2 inches (38 mm).
  - Fasten siding using a min. 6 and 12 nailing pattern. This requires one fastener every 6 inches (152 mm) o.c. along the perimeter and 12 inches (305 mm) o.c. in the field.
  - A tighter nail pattern of 6 and 6, or a longer nail embedment of 2 inches (51 mm) may be required depending on the wind pressure, wind speed and wind exposure Category limitations in PR-N124.
- A reduction in allowable racking shear capacity is required in Table 1 of both [PR-N124](#) and [ESR-1301](#) when using panel siding with a shiplap edge.
- In braced wall assemblies:
  - Use a min. (0.113 inch shank diameter) hot-dip galvanized (ASTM A153) or equivalent nail for 38 and 76 Series panel siding.
  - Use a min. (0.131 inch shank diameter) hot-dip galvanized (ASTM A153) or equivalent nail for 190 Series panel siding.
  - When using panel siding as **both** wall bracing and siding consult Table 1 of PR-N124 or ESR-1301 for fastener spacing; or consult a design professional.
- In non-braced wall assemblies:
  - A min. 0.092 inch smooth shank diameter nail may be substituted depending on the wind pressure, wind speed and wind exposure category limitations in PR-N124 or ESR-1301.
- For **38 Series** shiplap edge panel, the **double nailing** procedure meets wall bracing requirements for 5/16 Performance Category shear wall design value in Table 1 of PR-N124 or ESR-1301. (Figure 4a, 4b)
  - Exception: 38 Series square edge panel **single nailing** procedure meets wall bracing requirements for 3/8 Category shear wall design value in Table 1. (Figure 4c)



**Double nailing option**  
Figure 4a

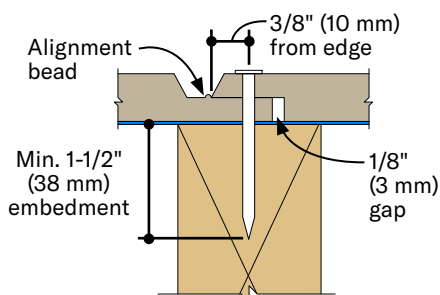


**Double nailing option**  
Figure 4b

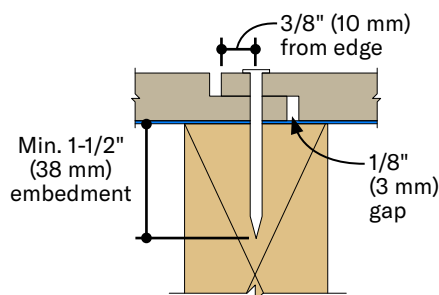


**Single nailing option**  
Figure 4c

- For **76 and 190 Series** shiplap edge panel **single nailing** procedure meets wall bracing requirements for 5/16 Performance Category shear wall design value in Table 1 of PR-N124 or ESR-1301. (Figure 4d, 4e)
  - To meet the equivalent 3/8 Performance Category shear wall design value, **double nailing** must be used. (Figure 4a)



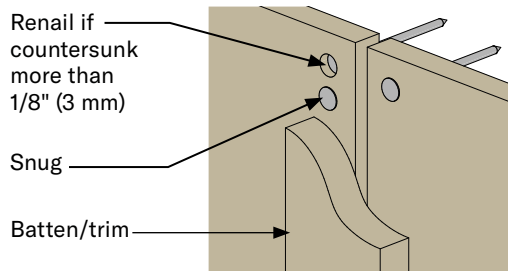
**Single nailing option**  
Figure 4d



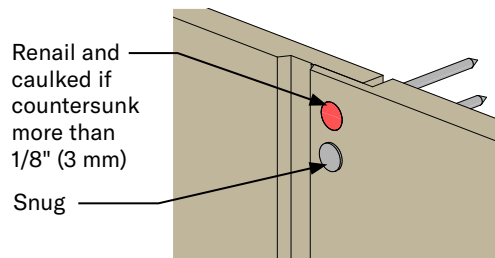
**Single nailing option**  
Figure 4e

## FASTENING INSTRUCTIONS (CONT'D.)

- Do not overdrive nails.
  - Nail head should seat snug to face of siding, but not flush to distort the siding surface.
    - Countersunk is considered overdriven.
  - **Blind nails:** re-nailing will be required when nailhead is countersunk more than 1/8 inch (3 mm). (Figure 5a)
  - **Face nails:** will occur immediately below window sills, soffit, frieze boards, and horizontal trim.
    - Renail and caulk if overdriven more than 1/8 inch (3 mm). (Figure 5b)
- Painting all exposed nail heads is recommended.

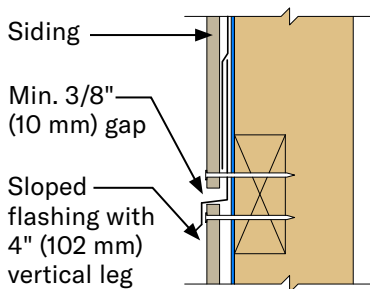


**Figure 5a**  
**BLIND NAILED CONDITION**



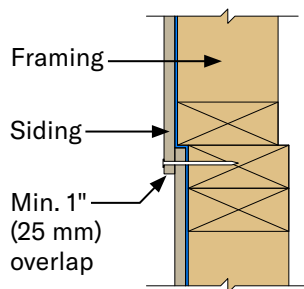
**Figure 5b**  
**FACE NAILED CONDITION**

## HORIZONTAL PANEL SEAM DETAILS



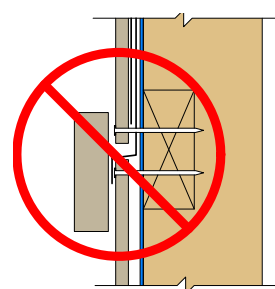
**Flashing Detail at Horizontal Panel Seam**

**Figure 5c**



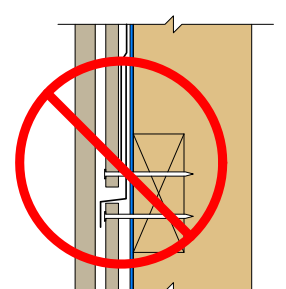
**Overlap Detail at Horizontal Panel Seam**

**Figure 5d**



**Do Not Install Trim at Horizontal Panel Seam**

**Figure 5e**

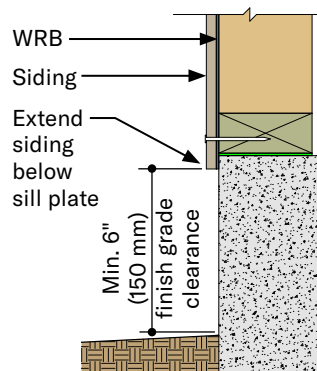


**Do Not Span Batten over Horizontal Panel Seam**

**Figure 5f**

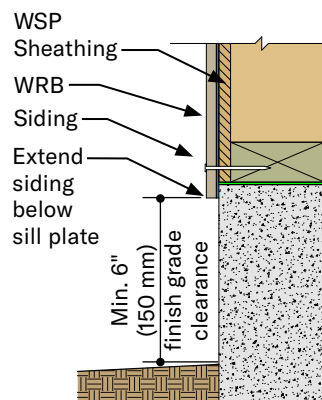
## CLEARANCE & SEPARATION GUIDELINES

- Min. 6 inch (152 mm) clearance must be maintained between siding and finish grade (ground cover). *[Min. 200 mm (8 inch) clearance must be maintained between cladding and finish ground when installing cladding in Canada in accordance with NBC, Section 9.27.2.4.(1) or local building code requirements.]*
- Provide separation between back of siding and concrete or masonry foundation. Separation can be achieved using a WRB, flashing, or similar product. (Figures 5g, 5h)



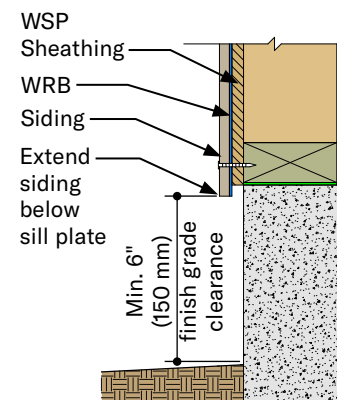
**Direct to Stud Attachment**

**Figure 5g**



**Direct to Stud w/WSP Attachment**

**Figure 5h**



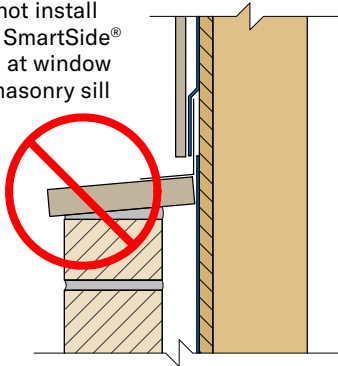
**WSP Sheathing Attachment**

**Figure 5i**

## SIDING OR TRIM ADJACENT TO STUCCO/MASONRY

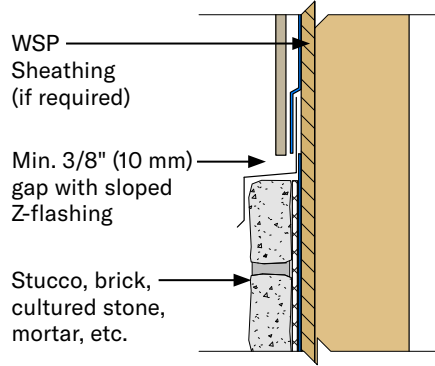
- Do not install trim or siding horizontally to create ledge or window sill. (Figure 6a)
- Where siding is installed directly adjacent to stucco, brick, cultured stone, mortar, etc., leave a min. 3/8 inch (10 mm) gap and caulk, backer rod recommended. (Figure 6b, 6c, 6d)

Do not install LP® SmartSide® trim at window or masonry sill



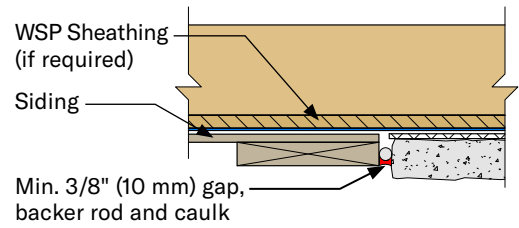
Section View

Figure 6a



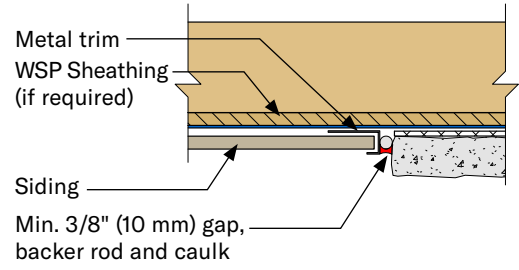
Section View

Figure 6b



Plan View

Figure 6c

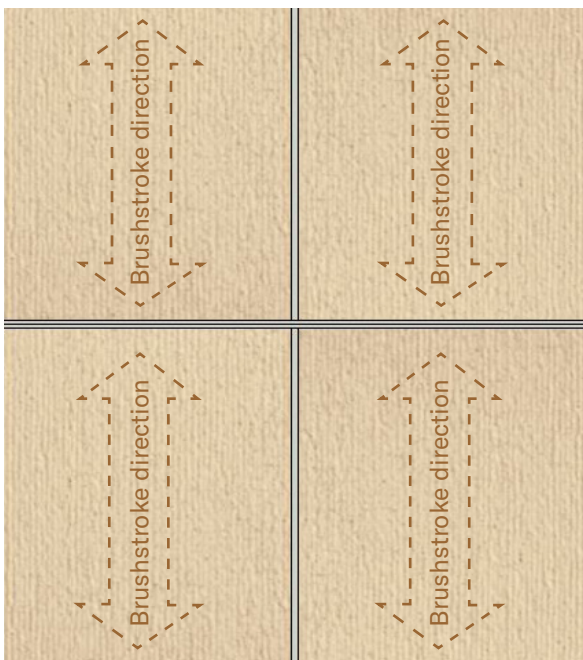


Plan View - Metal Trim

Figure 6d

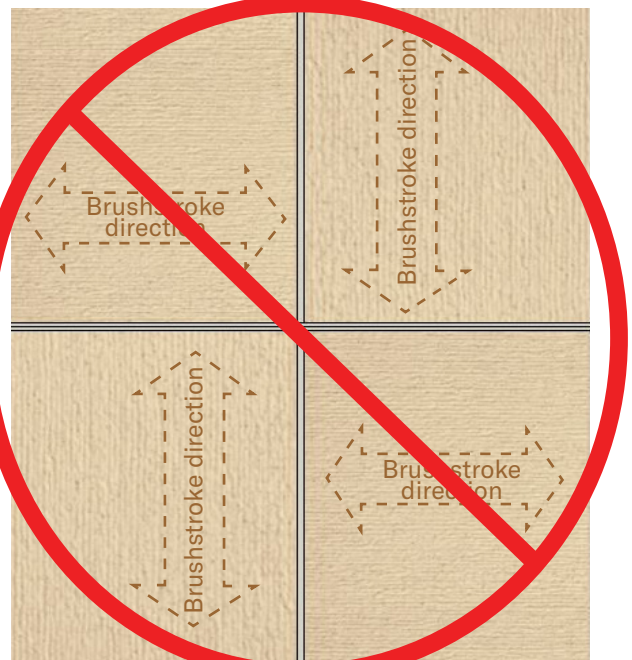
## SIDING TEXTURE ORIENTATION

- Cedar Texture, Brushed Smooth or Pebbled Stucco with square edges may be installed in either the horizontal or vertical orientation when applied with metal trim systems. (Technical Note #015)
- For a consistent finish appearance, ensure Cedar Texture or Brushed Smooth panel is installed in the same orientation.
  - Cedar Texture has a texture that runs parallel to the long panel direction. Ensure texture is applied in the same direction.
  - Brushed Smooth has a subtle brushstroke texture, this texture runs parallel to the long panel direction and can be used to identify the panel orientation even after the panels have been reduced in size.
  - See Figures 6d, 6e showing directional arrows to familiarize yourself with this feature before beginning installation.
  - This requirement does not apply to Pebbled Stucco Panel Siding.



**BRUSHED SMOOTH or CEDAR TEXTURE**  
Brushstroke Texture - Parallel

Figure 6d



**BRUSHED SMOOTH or CEDAR TEXTURE**  
Brushstroke Texture - NOT Parallel

Figure 6e

## FINISHING INSTRUCTIONS

- When caulk is required, use a high-quality, non-hardening, paintable sealant meeting ASTM C920, min. Class 25.
  - Follow sealant manufacturer's instructions for application.
- Paint all exposed surfaces, including all drip edges or where water will hang. For best results, use a high-quality 100% acrylic exterior paint specially formulated for use on wood and engineered wood substrates; oil paint is acceptable.
  - DO NOT USE stain or vinyl-based paint.
  - Apply paint as soon as possible and within 180 days.
- Follow paint manufacturer's instructions for application.
- Follow LP's Care & Maintenance Instructions.

### CEDAR TEXTURE Panel Siding:

- For best results use semi-gloss finish.

### BRUSHED SMOOTH or PEBBLED STUCCO Panel Siding:

- Either flat, satin or semi-gloss coatings can be applied to brushed smooth or pebbled stucco panel siding.
  - Each offers different appearance & maintenance benefits.

## FASTENING OPTIONS OVER FOAM PLASTIC SHEATHING (RIGID FOAM INSULATION)

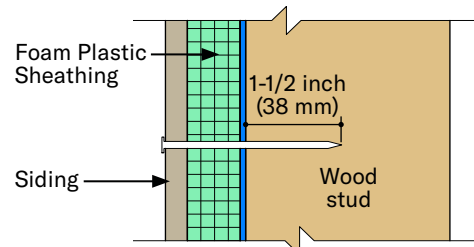
- Panel siding may be installed directly over foam plastic sheathing.

### FOAM PLASTIC SHEATHING ≤ 1 INCH (25 MM)

- Increase nail length to ensure a min. 1-1/2 inch (38 mm) penetration into studs (Figure 7a), or combination of studs and WSP sheathing; or nail length long enough to fully penetrate sheathing a min. 1/4 inch (6 mm) for a sheathing only attachment. (Figure 7b)

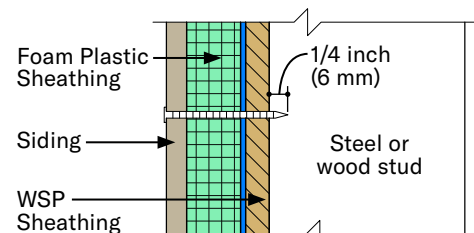
### FOAM PLASTIC SHEATHING > 1 INCH (25 MM)

- Siding attachment: Refer to IRC Chapter 7, Wall Covering for prescriptive siding attachments over foam sheathing up to 4 inches (102 mm) thick, direct to wood or steel studs for support of siding weight only. **Does NOT include wind loads.**
  - Refer to Table 703.15.1 for min. fastening requirements over foam sheathing to wood studs.
  - Refer to Table 703.16.1 for min. fastening requirements over foam sheathing to steel studs.
- Fastener placement:
  - Nail spacing depends on siding attachment method;
    - Direct to Stud or WSP sheathing attachment, and
    - Wind load limitations in [PR-N124](#) or [ESR-1301](#).
- LP assumes no liability for loss or damage associated with fastening requirements of the applicable code.



**Siding over Foam Plastic Sheathing to Wood Studs**

**Figure 7a**



**Siding over Foam Plastic Sheathing to WSP**

**Figure 7b**

## ADDITIONAL FASTENING OPTIONS

### EXTERIOR GYPSUM SHEATHING

- Siding may be installed over a max. 1 inch (25 mm) exterior gypsum sheathing, according to the following:
  - Adequate bracing of the wall is provided in accordance with the local building code.
  - Nail length must be increased to ensure a min. penetration into wood studs, or combination of WSP sheathing and wood studs.

### EXISTING WOOD SIDING OR WOOD COMPOSITE SIDING

- Siding may be installed over existing wood or wood composite siding, if the existing siding does not affect the ability to correctly install siding.
  - A properly installed WRB is required between the existing siding and the new siding.
  - A uniform surface behind siding is required to avoid contouring of siding.
    - Do not install over existing siding that is not flat or uniform.
  - Min. nail penetration and max. stud spacing must not be compromised.
  - Ensure wall assembly meets structural requirements specified in building code and by local code authority.
  - Repair any areas of the existing siding that are not structurally sound, not installed correctly, or exhibit signs of decay.

## FIRE-RATING

### CAL FIRE WUI

- California Building Code, Chapter 7A [SFM] Materials and Construction Methods for Exterior Wildfire Exposure compliance can be achieved using LP® SmartSide® panel siding installed as described in:
  - CAL FIRE BML# 8140-2027:0002 applies to 76 and 190 Series panel siding applied direct to studs.
    - For WUI compliance, install panel siding** in accordance with Louisiana-Pacific's printed application instructions **with the addition of a paintable fire retardant sealant** [UL Listed fire caulk, nominal 1/4 inch (6 mm) bead] **in the vertical joint, and using an enhanced nailing pattern of 3 inch (76 mm) o.c. perimeter nailing and 8 inch (203 mm) o.c. field nailing.** Look for the California State Fire Marshal Office label on LP SmartSide panel siding.
      - This listing does not apply to 38 Series panel siding.

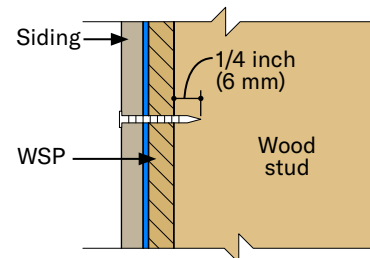
### FIRE-RATED WALL ASSEMBLY

- LP SmartSide panel siding may be installed over the exterior portion of a 1-hour fire-resistive exterior wall assembly, including assemblies using gypsum wallboard listed in the Gypsum Association Fire Resistance Design Manual.
- For information on fire-rated wall assemblies: <https://lpcorp.com/products/panels-sheathing/fire-rated-osb-sheathing/assemblies>

## ALTERNATIVE FASTENING OPTIONS

### WOOD STRUCTURAL PANEL (WSP) SHEATHING OR SIP ASSEMBLIES

- WSP wall sheathing must be a min. 7/16 Performance Category with APA Trademark Stamp that contains the consensus Standard DOC PS 1 or DOC PS 2. [In Canada in accordance with CSA O437]
- Siding may be nailed to SIP assembly or WSP sheathing. (Figure 8a)
  - Min. 0.092 inch diameter **ring shank**, hot-dip galvanized nail (ASTM A153) or equivalent.
    - Nail length must be long enough to fully penetrate sheathing by at least 1/4 inch (6 mm).
    - Fasten in a grid pattern of a min. 8 inches (203 mm) o.c. up to a max. 16 inches (305 mm) o.c. depending on the wind pressure, wind speed and wind exposure category limitation in PR-N124, Table 5.
    - Ensure that the ring shanks of the nail fully engage the WSP sheathing.

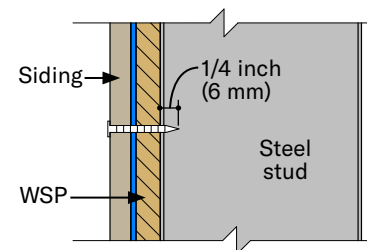


**Siding nailed to WSP Sheathing**

**Figure 8a**

### STEEL STUD FRAMING - ONLY APPLIES TO FULLY SHEATHED WALLS

- WSP wall sheathing must be a min. 7/16 Performance Category with APA Trademark Stamp that contains the consensus Standard DOC PS 1 or DOC PS 2. [In Canada in accordance with CSA O437]
- Siding may be nailed to WSP sheathing. (Figure 8b)
  - Min. 0.092 inch diameter **ring shank**, hot-dip galvanized nail (ASTM A153) or equivalent.
    - Nail length must be long enough to fully penetrate sheathing by at least 1/4 inch (6 mm).
    - Ensure that the ring shanks of the nail fully engage the WSP sheathing.
  - Space fasteners according to the wind pressure, wind speed and wind exposure category limitations in PR-N124, Table 4a or 4b.



**Siding nailed to WSP Sheathing**

**Figure 8b**

### PANEL CLADDING OVER FURRING IN CANADA

- Cladding must be installed over a min. 19 mm by 64 mm (3/4 inch x 2-1/2 inch) actual size furring members, when applied without sheathing, on supports spaced no more than 400 mm (16 inch o.c.). (Figures 9a, 9b, 9c, 9d)
- Current building science practices recommend ventilation at top & bottom of wall.
  - Openings at top and bottom of wall should be open to outside air and protected with insect screen. (Figures 10a, 10e)
  - Check with local building codes for additional requirements.
- Cladding shall be installed to safely resist all loads, including wind loads, of the locally adopted building codes. The installation of cladding shall result in a system that provides a load path that meets the requirements for the transfer of loads from the point of origin through the load-resisting elements to the structure. The mechanical connection of the furring to structure is the responsibility of a design professional. LP assumes no liability for any loss or damage caused by the design of the mechanical connection of the furring to the structure and is expressly released by the purchaser or owner from any such loss or liability.

## ALTERNATIVE FASTENING OPTIONS (CONT'D.)

### PANEL CLADDING OVER FURRING IN CANADA (CONT'D.)

#### LIMITATIONS OF USE:

- For use in Canada only.
- Panel cladding cannot be used for lateral bracing with this attachment method.
- Attach LP® SmartSide® panel cladding to furring per Table 1:

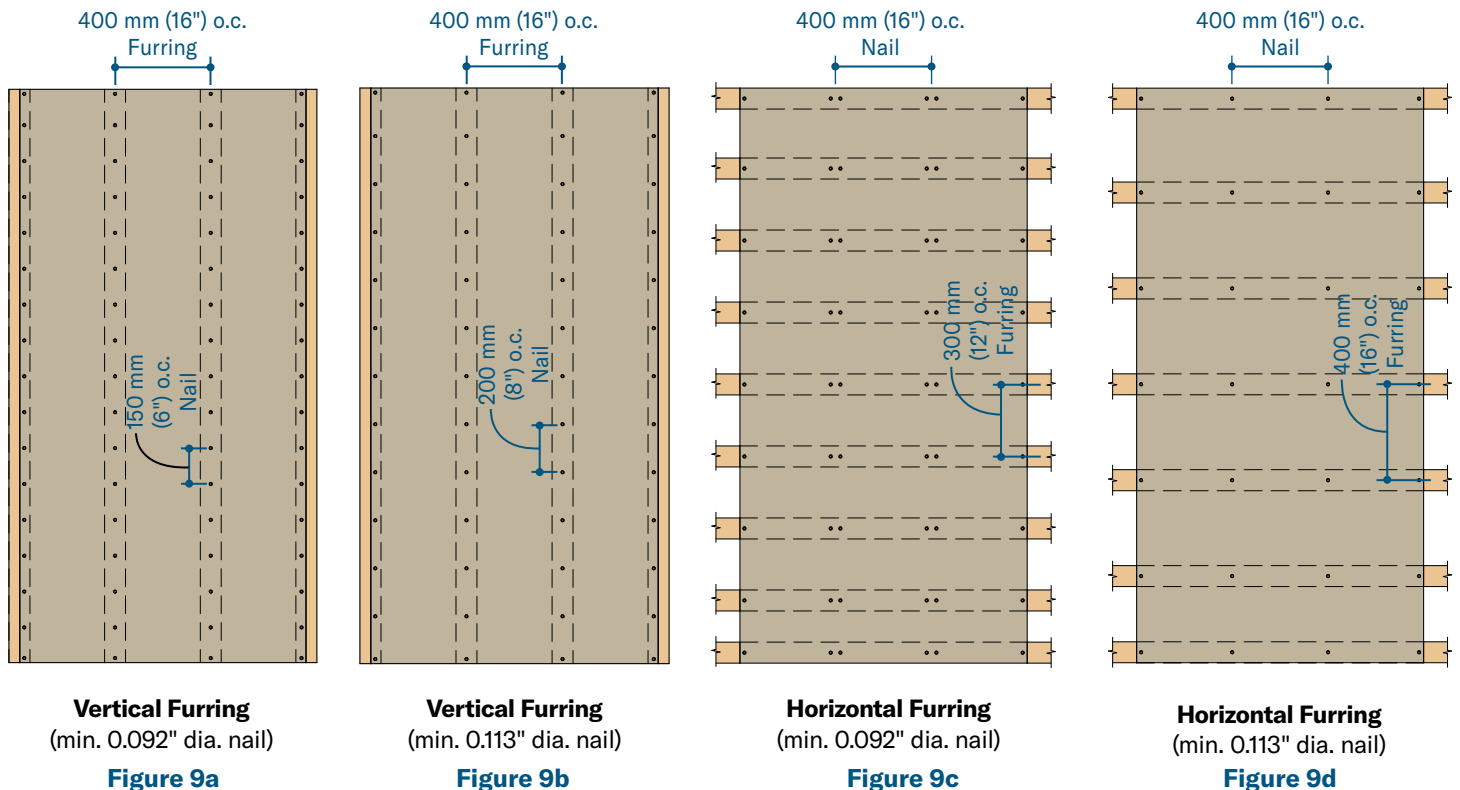
**Table 1**

Panel Cladding (Siding) Installed Vertically Meets Maximum Design Wind Speed of 32.4 m/s (72.5 mph) per 2015 National Building Code of Canada				
Panel Sizes	Furring <sup>(1)</sup>	Furring Spacing	Minimum Fastener Size	Fastener Spacing
1 219 mm x 2.4 m (4' x 8')	<b>Vertical</b> 19 mm x 64 mm (3/4" x 2-1/2") furring attached to framing <sup>(2)</sup>	400 mm (16" o.c.)	<b>0.092" x 51 mm</b> (2") HDG <sup>(3)</sup> <b>ring shank</b> nail	One nail every 150 mm (6") o.c. into cladding and furring only (See Figure 9a)
1 219 mm x 2.7 m (4' x 9')			<b>0.113" x 51 mm</b> (2") HDG <sup>(3)</sup> <b>ring shank</b> nail	One nail every 200 mm (8") o.c. into cladding and furring only (See Figure 9b)
or	<b>Horizontal</b> 19 mm x 64 mm (3/4" x 2-1/2") furring attached to framing <sup>(2)</sup>	300 mm (12" o.c.)	<b>0.092" x 51 mm</b> (2") HDG <sup>(3)</sup> <b>ring shank</b> nail	<b>Two nails<sup>(4)</sup></b> every 400 mm (16") o.c. into cladding and furring only (See Figure 9c)
1 219 mm x 3 m (4' x 10')		400 mm (16" o.c.)		

**Footnotes:**

- (1) Furring shall be min. 19 mm by 64 mm (3/4"x 2-1/2") actual size with specific gravity of 0.42 or greater per AWC/NDS
- (2) The mechanical connection of the furring to structure is the responsibility of a design professional.
- (3) Fasteners shall meet or exceed the corrosion-resistance of hot-dip galvanized requirements of ASTM A153, Class D.
- (4) When double nailing, space fasteners a min. 6 mm (1/4") apart.

#### FURRING AND FASTENER SPACING



## ALTERNATIVE FASTENING OPTIONS (CONT'D.)

### FASTENING TO VERTICAL FURRING

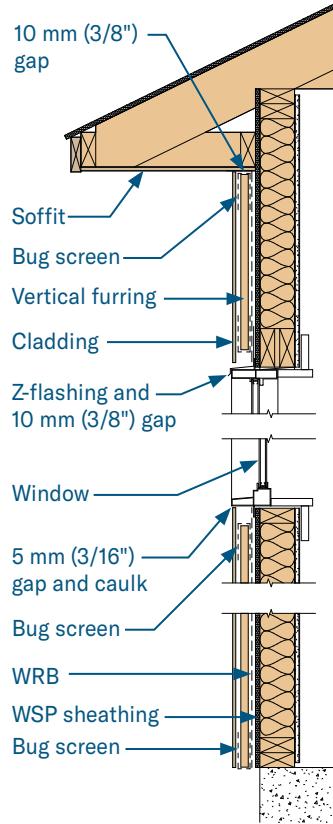


Figure 10a

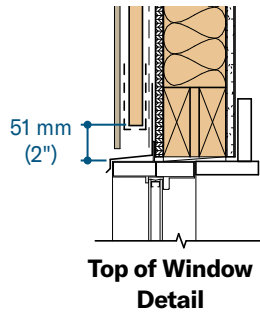


Figure 10b

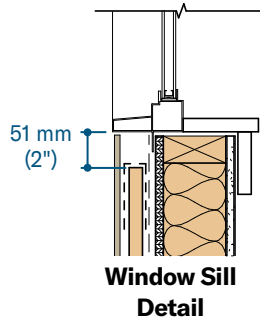


Figure 10c

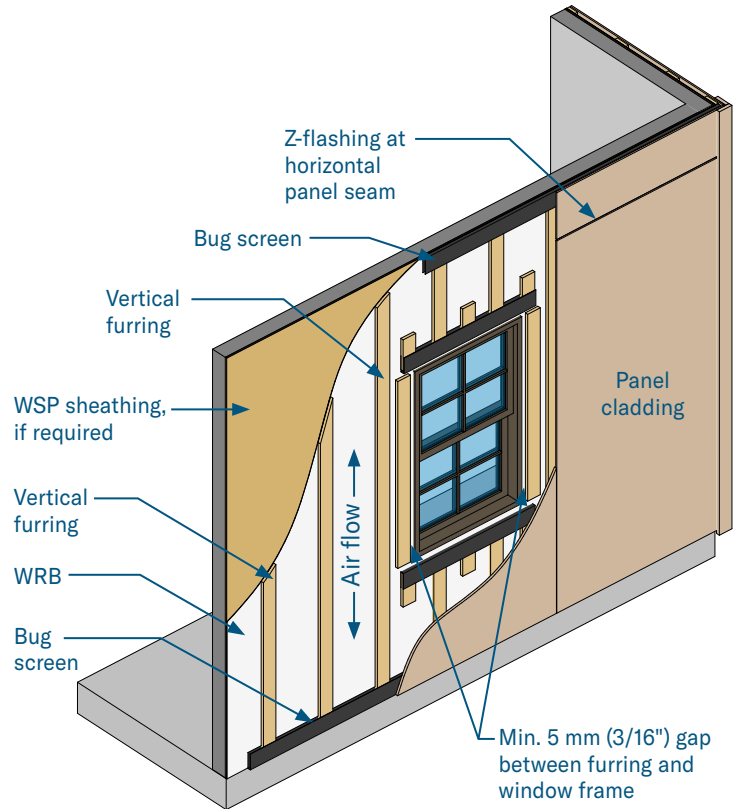


Figure 10d

### FASTENING TO DOUBLE FURRING

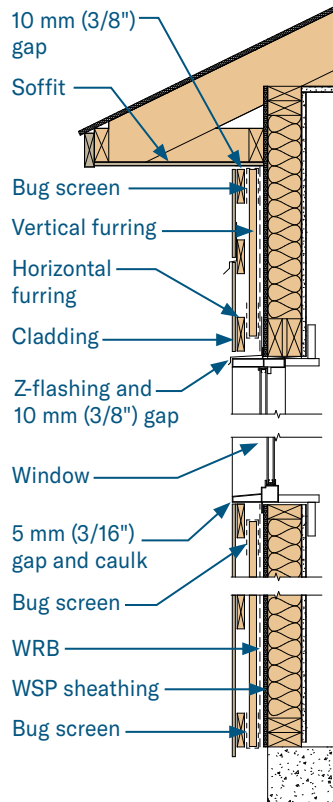


Figure 10e

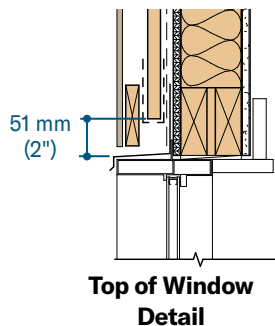


Figure 10f

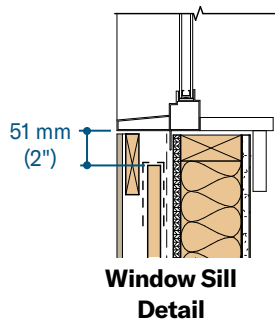


Figure 10g

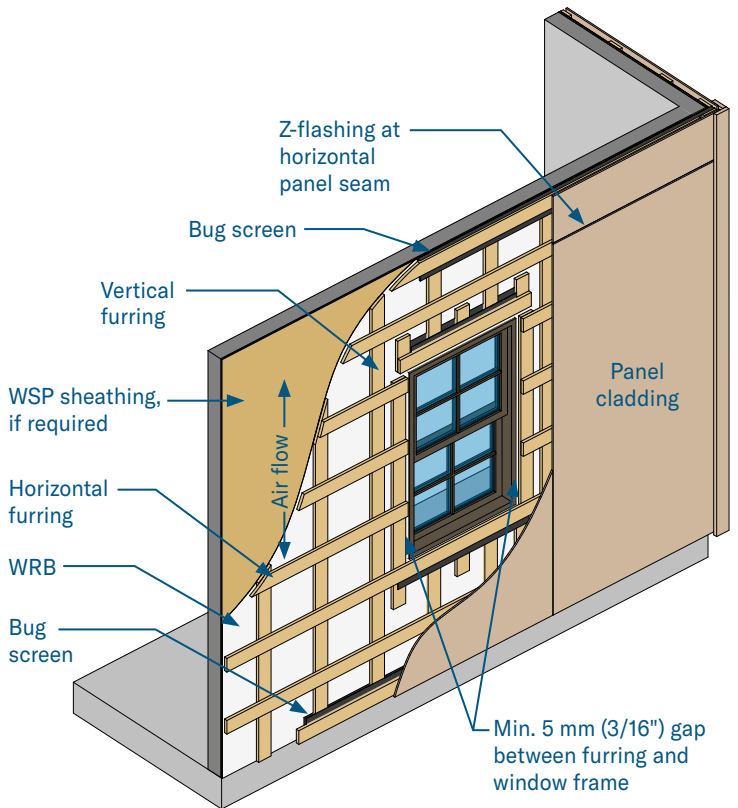
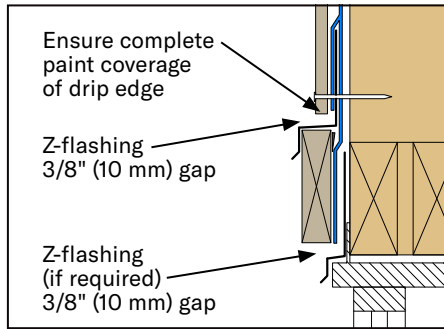
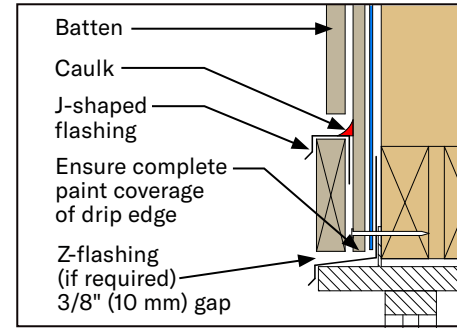


Figure 10h

## DETAILS



**Z-FLASHING OVER  
DOOR & WINDOW OPENINGS  
PREFERRED**



**J-SHAPED FLASHING OVER  
DOOR & WINDOW OPENINGS  
ALTERNATE**

Figure 11a

Figure 11b

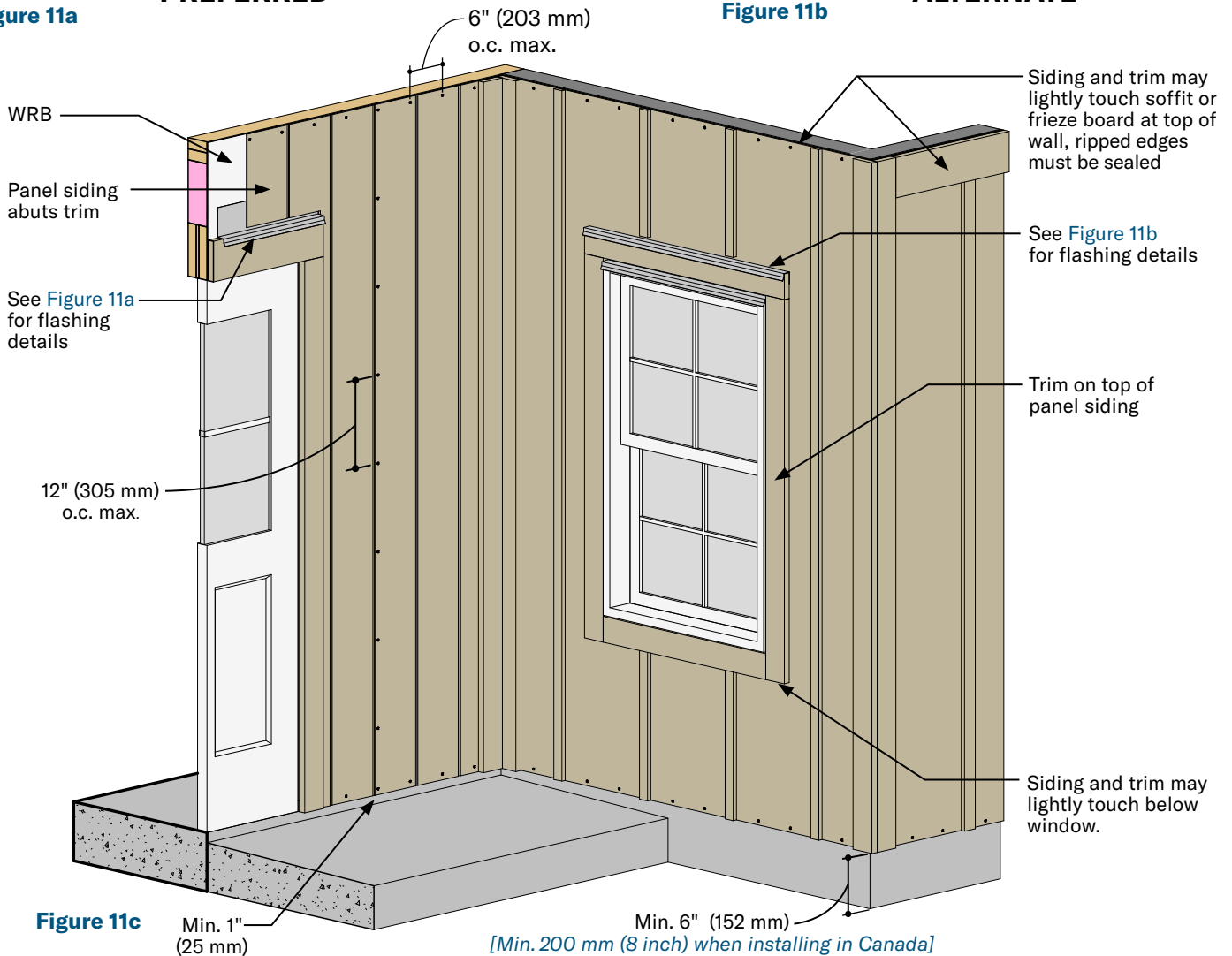
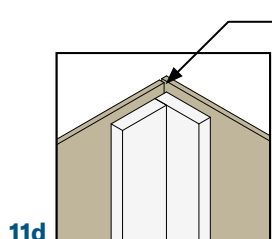
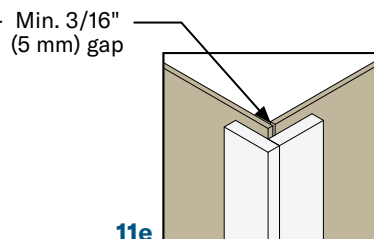


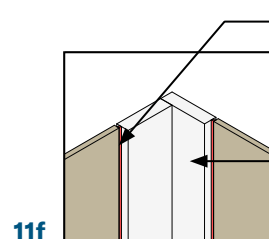
Figure 11c



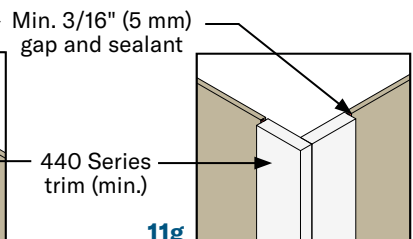
**INSIDE CORNER  
PREFERRED**



**OUTSIDE CORNER  
PREFERRED**



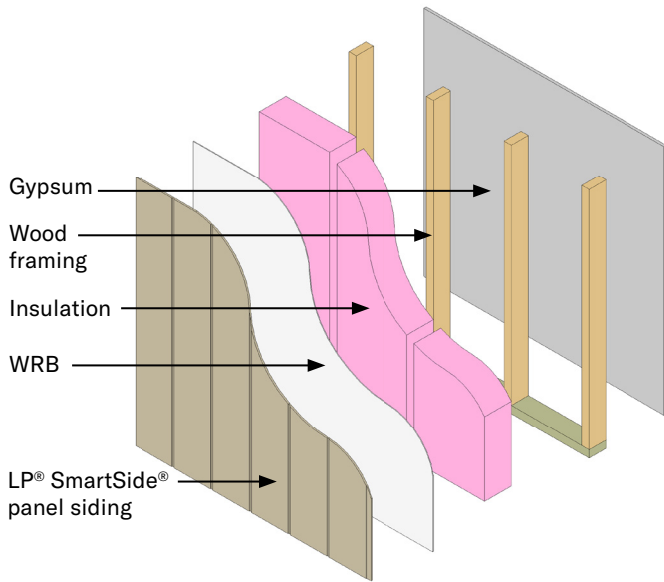
**INSIDE CORNER  
ALTERNATE**



**OUTSIDE CORNER  
ALTERNATE**

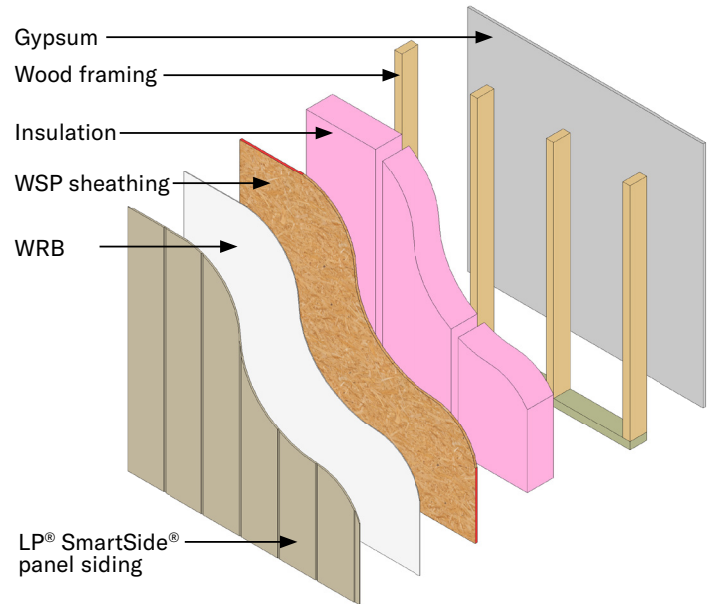
## WOOD FRAMED WALL ASSEMBLIES - EXAMPLES

- WRB location in wall assembly may vary depending on climate zone or other factors.



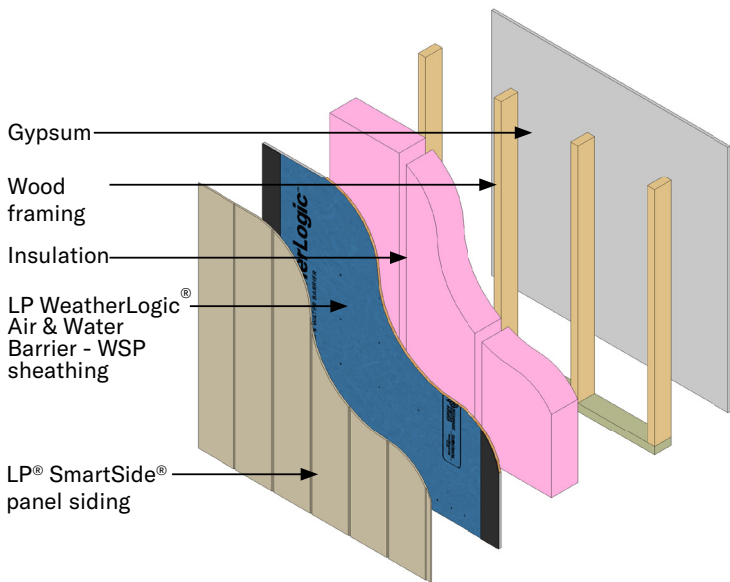
**Siding  
without Sheathing**

**Figure 12a**



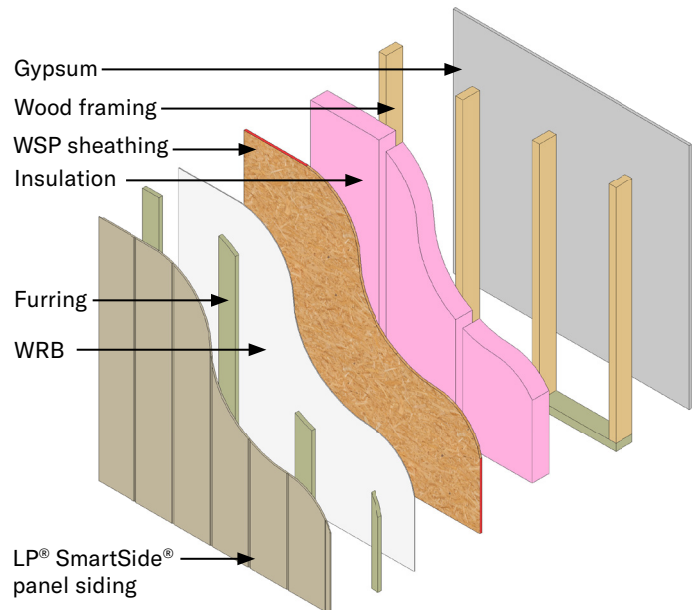
**Siding  
with WSP Sheathing**

**Figure 12b**



**Siding  
with LP® WeatherLogic®**

**Figure 12c**



**Furring with WSP Sheathing  
(Canada Only)**

**Figure 12d**

# LP® SmartSide® Panel Siding

## Application Tips

**IMPORTANT** Always refer to the complete application instructions for the product you are installing. The application tips provided below are not intended to replace such instructions. Application instructions can be found at [LPCorp.com](http://LPCorp.com). Failure to follow the full application instructions could cause personal injury or property damage, affect system performance, void any applicable warranty and/or violate applicable building codes.

Exercise safe practices at all times while handling and using this product. Refer to the relevant Safety Data Sheet (SDS) for important information on the safe handling and use of this product. These can be found at [LPCorp.com](http://LPCorp.com).

Panel siding may be attached Direct to Studs or Direct to Wood Structural Panel (WSP) Sheathing:

- **Direct to Stud** - nails must penetrate structural framing, or combination of WSP and structural framing min. 1-1/2" (38 mm), some installations may require 2" (51 mm) penetration, see [PR-N124](#) or [ESR-1301](#)
- **Direct to WSP Sheathing** - nails must be long enough to penetrate beyond WSP by 1/4" (6 mm)

Stud spacing – see application instructions for spacing from 16" (406 mm) o.c. to 24" (610 mm) o.c.

Panel siding attached to ICF is NOT RECOMMENDED – LP will not warrant against buckling

Nail size in **braced wall assemblies** (panel siding for structural use):

- 38 & 76 Series – use a min. 0.113" shank dia. hot-dip galvanized (ASTM A153) nail
- 190 Series – use a min. 0.131" shank dia. hot-dip galvanized (ASTM A153) nail

Nail size in **non-braced wall assemblies** (panel siding for non-structural use):

- Min. 0.092" shank diameter hot-dip galvanized (ASTM A153) nail may be substituted depending on wind pressure, wind speed and wind exposure limitations in PR-N124 or ESR-1301

Nail size for **sheathing only** attachment (panel siding attached to WSP wall sheathing):

- Min. 0.092" shank diameter hot-dip galvanized (ASTM A153) **ring shank** nail

Nail placement – 3/8" (10 mm) from ends

Nail spacing in braced and non-braced wall assemblies:

- Edge nailing – 6" (152 mm) o.c.; or less if panel siding used in shear wall design, see PR-N124 or ESR-1301
- Field nailing – 12" (200 mm) o.c.; or less in some shear wall or wind load designs, see PR-N124 or ESR-1301

Nail spacing for **sheathing only** attachment (panel siding attached to WSP sheathing):

- Nailing pattern varies from a **grid pattern** at 8" (200 mm) o.c. to 16" (406 mm) o.c. depending on wind pressure, wind speed and wind exposure limitations in PR-N124 or ESR-1301

Horizontal joints – must be flashed with non-corrosive Z-flashing, spaced min. 3/8" (10 mm) above flashing

For **single** and **double nailing** guidelines - See Application Instructions

Do not overdrive nails – nail head should seat snug to the face of siding

Caulk – use a high-quality, non-hardening, paintable exterior sealant meeting ASTM C920, min. Class 25

Seal all exposed substrate – sealing can be accomplished by applying a paint or caulk

Where panels butt up against a window, door, and corner trim space – min. 3/16" (5 mm)

Siding clearance at finish grade (ground cover) – min. 6" (152 mm) [*Min. 200 mm (8 inch) when installing in Canada*]

Siding clearance adjacent to surfaces such as porches, patios, or porch columns, etc. – min. 1" (25 mm) clearance:

- May be reduced to 3/8" (10 mm) subject to certain conditions - see Application Instructions

Siding must not be in direct contact with CMU, poured concrete, brick, cultured stone, stucco, mortar, etc.

Flashing is required above all windows, doors and horizontal trim per manufacturer's instructions:

- Flashing shall be metal or another durable material that will last for not less than 50 years
- Provide 3/8" (10 mm) gap above any drip cap flashing, **do not caulk gap**

Siding below a windowsill, soffit, horizontal trim or frieze board will require face-nailing - see Application Instructions

Siding over foam plastic sheathing adds complexity to siding installation – see Application Instructions

For Limitations of Use – see Application Instructions, Technical Notes, Technical Bulletins and NSA Bulletins