

# spex®

Shaping Better Lives

SISTEMI DI  
POSTURA

SCHEDA D'ORDINE

SPEXSEATING.COM



Prezzi in €, aggiornati il 1/01/2023

	Nr Reg. Ministero	CND
MF11 Cuscini	2284333	Y180939
MF12 Schienali	2284348	"
MF1266 Supporto laterale tronco	2284355	"
MF14 Cinghie, bretellaggi e stabilizzatori	2284385	"
MF1162 Divaricatore	2284395	"
MF1270 Postura capo	2284401	"

## ottobock.

**Preventivo costi**

**Ordine**

Timbro Rivenditore con indirizzo di fatturazione

Indirizzo di spedizione (se diverso dall'indirizzo Rivenditore)

Data

Firma Rivenditore

.....

Ordine Nr.:

-----

I codici Spex in **grassetto** sono regolarmente presenti a magazzino (tempo di evasione ca. 2 settimane, gli altri ca. 60 giorni)

# Sedute Spex



SPEX STANDARD CONTOUR (spessore minimo 3 cm)

LARGH. NOMINALE	PROF. NOMINALE	Q.TA'	CODICE	€
10" (25 cm)	12" (30 cm)		<b>1105-1012-0SC</b>	638
11" (28 cm)	12" (30 cm)		1105-1112-0SC	
12" (30 cm)	12" (30 cm)		<b>1105-1212-0SC</b>	
	14" (36 cm)		<b>1105-1214-0SC</b>	
	16" (41 cm)		1105-1216-0SC	
13" (33 cm)	14" (36 cm)		<b>1105-1314-0SC</b>	
	16" (41 cm)		1105-1316-0SC	
14" (36 cm)	15" (38 cm)		<b>1105-1415-0SC</b>	
	16" (41 cm)		<b>1105-1416-0SC</b>	
	17" (43 cm)		1105-1417-0SC	
15" (38 cm)	16" (41 cm)		<b>1105-1516-0SC</b>	
	17" (43 cm)		<b>1105-1517-0SC</b>	
	18" (46 cm)		1105-1518-0SC	
16" (41 cm)	16" (41 cm)		<b>1105-1616-0SC</b>	
	17" (43 cm)		<b>1105-1617-0SC</b>	
	18" (46 cm)		<b>1105-1618-0SC</b>	
	20" (51 cm)		<b>1105-1620-0SC</b>	
17" (43 cm)	17" (43 cm)		<b>1105-1717-0SC</b>	
	18" (46 cm)		<b>1105-1718-0SC</b>	
	20" (51 cm)		<b>1105-1720-0SC</b>	
18" (46 cm)	18" (46 cm)		<b>1105-1818-0SC</b>	
	20" (51 cm)		<b>1105-1820-0SC</b>	
20" (51 cm)	22" (56 cm)		1105-2022-0SC	

# Sedute Spex High



SPEX HIGH CONTOUR (spessore minimo 5 cm)

LARGH.	PROF.	Q.TA'	CODICE	€
10" (25 cm)	10" (25 cm)		1105-1010-0HC	660
	12" (30 cm)		<b>1105-1012-0HC</b>	
11" (28 cm)	10" (25 cm)		1105-1110-0HC	
	12" (30 cm)		<b>1105-1112-0HC</b>	
12" (30 cm)	12" (30 cm)		<b>1105-1212-0HC</b>	
	14" (36 cm)		<b>1105-1214-0HC</b>	
	16" (41 cm)		<b>1105-1216-0HC</b>	
13" (33 cm)	14" (36 cm)		<b>1105-1314-0HC</b>	
	16" (41 cm)		<b>1105-1316-0HC</b>	
14" (36 cm)	14" (36 cm)		<b>1105-1414-0HC</b>	
	15" (38 cm)		<b>1105-1415-0HC</b>	
	16" (41 cm)		<b>1105-1416-0HC</b>	
	17" (43 cm)		<b>1105-1417-0HC</b>	
15" (38 cm)	18" (46 cm)		<b>1105-1418-0HC</b>	
	14" (36 cm)		<b>1105-1514-0HC</b>	
	16" (41 cm)		<b>1105-1516-0HC</b>	
	17" (43 cm)		<b>1105-1517-0HC</b>	
16" (41 cm)	18" (46 cm)		<b>1105-1518-0HC</b>	
	16" (41 cm)		<b>1105-1616-0HC</b>	
	17" (43 cm)		<b>1105-1617-0HC</b>	
	18" (46 cm)		<b>1105-1618-0HC</b>	
17" (43 cm)	20" (51 cm)		<b>1105-1620-0HC</b>	
	17" (43 cm)		<b>1105-1717-0HC</b>	
	18" (46 cm)		<b>1105-1718-0HC</b>	
	20" (51 cm)		<b>1105-1720-0HC</b>	
18" (46 cm)	18" (46 cm)		<b>1105-1818-0HC</b>	
	20" (51 cm)		<b>1105-1820-0HC</b>	
19" (48 cm)	18" (46 cm)		<b>1105-1918-0HC</b>	
20" (51 cm)	20" (51 cm)		<b>1105-2020-0HC</b>	
	22" (56 cm)		1105-2022-0HC	

# Sedute Spex SuperHigh



LARGH. NOMINALE	PROF. NOMINALE	Q.TA'	CODICE	€
10" (25 cm)	10" (25 cm)		<b>1105-1010-0SH</b>	660
	12" (30 cm)		<b>1105-1012-0SH</b>	
11" (28 cm)	10" (25 cm)		1105-1110-0SH	
	12" (30 cm)		<b>1105-1112-0SH</b>	
12" (30 cm)	12" (30 cm)		1105-1212-0SH	
	14" (36 cm)		<b>1105-1214-0SH</b>	
	16" (41 cm)		<b>1105-1216-0SH</b>	
13" (33 cm)	12" (30 cm)		1105-1312-0SH	
	14" (36 cm)		<b>1105-1314-0SH</b>	
	16" (41 cm)		<b>1105-1316-0SH</b>	
14" (36 cm)	14" (36 cm)		<b>1105-1414-0SH</b>	
	15" (38 cm)		<b>1105-1415-0SH</b>	
	16" (41 cm)		<b>1105-1416-0SH</b>	
	17" (43 cm)		<b>1105-1417-0SH</b>	
15" (38 cm)	18" (46 cm)		<b>1105-1418-0SH</b>	
	14" (36 cm)		<b>1105-1514-0SH</b>	
	16" (41 cm)		<b>1105-1516-0SH</b>	

LARGH. NOMINALE	PROF. NOMINALE	Q.TA'	CODICE	€
15" (38 cm)	17" (43 cm)		<b>1105-1517-0SH</b>	660
	18" (46 cm)		<b>1105-1518-0SH</b>	
16" (41 cm)	16" (41 cm)		<b>1105-1616-0SH</b>	
	17" (43 cm)		<b>1105-1617-0SH</b>	
	18" (46 cm)		<b>1105-1618-0SH</b>	
	20" (51 cm)		<b>1105-1620-0SH</b>	
17" (43 cm)	17" (43 cm)		<b>1105-1717-0SH</b>	
	18" (46 cm)		<b>1105-1718-0SH</b>	
	20" (51 cm)		<b>1105-1720-0SH</b>	
18" (46 cm)	18" (46 cm)		<b>1105-1818-0SH</b>	
	20" (51 cm)		<b>1105-1820-0SH</b>	
19" (48 cm)	18" (46 cm)		<b>1105-1918-0SH</b>	
	20" (51 cm)		<b>1105-1920-0SH</b>	
20" (51 cm)	20" (51 cm)		<b>1105-2020-0SH</b>	

10"-13" spessore min.: 8 cm anteriormente  
14"+ spessore min.: 10 cm anteriormente



# Schienale Spex

## STEP 1: SCEGLI LA MISURA

LARGH. NOMINALE	ALTEZZA NOMINALE	Q.TA'	CODICE	€
10" (25 cm)	12" (30 cm)		1255-1012-0SS	989
	14" (36 cm)		<b>1255-1014-0SS</b>	
12" (30 cm)	14" (36 cm)		<b>1255-1214-0SS</b>	
	16" (41 cm)		<b>1255-1216-0SS</b>	
14" (36 cm)	18" (46 cm)		<b>1255-1218-0SS</b>	
	16" (41 cm)		<b>1255-1416-0SS</b>	
	18" (46 cm)		<b>1255-1418-0SS</b>	
16" (41 cm)	20" (51 cm)		1255-1420-0SS	
	16" (41 cm)		<b>1255-1616-0SS</b>	
18" (46 cm)	18" (46 cm)		<b>1255-1618-0SS</b>	
	20" (51 cm)		<b>1255-1620-0SS</b>	
20" (51 cm)	18" (46 cm)		<b>1255-1818-0SS</b>	1173
	20" (51 cm)		<b>1255-1820-0SS</b>	
	23" (58 cm)		<b>1255-1823-0SS</b>	
20" (51 cm)	18" (46 cm)		<b>1255-2018-0SS</b>	
	20" (51 cm)		<b>1255-2020-0SS</b>	



## STEP 2: SCEGLI IL KIT DI MONTAGGIO

✓	CODICE	IMMAGINE	TIPO	€
[ ]	1259-2400-100		Quad Quick Release	-
[ ]	1259-2405-100		Heavy Duty	40



# Schienale Super Shape

## STEP 1: SCEGLI LA MISURA

LARGH. NOMINALE	ALTEZZA NOMINALE	Q.TA'	CODICE	€
12" (30 cm)	12" (30 cm)		1256-1212-0SS	1319
	14" (36 cm)		<b>1256-1214-0SS</b>	
	16" (41 cm)		<b>1256-1216-0SS</b>	
14" (36 cm)	14" (36 cm)		<b>1256-1414-0SS</b>	
	16" (41 cm)		<b>1256-1416-0SS</b>	
	18" (46 cm)		<b>1256-1418-0SS</b>	
	20" (51 cm)		<b>1256-1420-0SS</b>	
16" (41 cm)	16" (41 cm)		<b>1256-1616-0SS</b>	
	18" (46 cm)		<b>1256-1618-0SS</b>	
	20" (51 cm)		<b>1256-1620-0SS</b>	
18" (46 cm)	23" (58 cm)		<b>1256-1623-0SS</b>	
	16" (41 cm)		<b>1256-1816-0SS</b>	1487
	18" (46 cm)		<b>1256-1818-0SS</b>	
20" (51 cm)		<b>1256-1820-0SS</b>		
20" (51 cm)	23" (58 cm)		<b>1256-1823-0SS</b>	
	18" (46 cm)		<b>1256-2018-0SS</b>	
	20" (51 cm)		<b>1256-2020-0SS</b>	
20" (51 cm)	20" (51 cm)		<b>1256-2020-0SS</b>	
	23" (58 cm)		<b>1256-2023-0SS</b>	



## STEP 2: SCEGLI IL KIT DI MONTAGGIO

✓	CODICE	IMMAGINE	TIPO	€
[ ]	1259-2400-100		Quad Quick Release	-
[ ]	1259-2405-100		Heavy Duty	40

# Schienale Vigour

## STEP 1: SCEGLI LA MISURA



LARGH. NOMINALE	ALT.	Q.TA'	CODICE	€
10" (25 cm)	12" (25 cm)		1252-1012-00H	810
	14" (36 cm)		1252-1014-00H	
12" (30 cm)	14" (36 cm)		<b>1252-1214-00H</b>	
	16" (41 cm)		<b>1252-1216-00H</b>	
14" (36 cm)	16" (41 cm)		<b>1252-1416-00H</b>	
	18" (46 cm)		<b>1252-1418-00H</b>	
16" (41 cm)	16" (41 cm)		<b>1252-1616-00H</b>	
	18" (46 cm)		<b>1252-1618-00H</b>	

LARGH.	ALT.	Q.TA'	CODICE	€
16" (41 cm)	20" (51 cm)		<b>1252-1620-00H</b>	810
17" (43 cm)	18" (46 cm)		1252-1718-00H	
18" (46 cm)	18" (46 cm)		<b>1252-1818-00H</b>	
	20" (51 cm)		<b>1252-1820-00H</b>	
20" (51 cm)	18" (46 cm)		<b>1252-2018-00H</b>	847
	20" (51 cm)		<b>1252-2020-00H</b>	
	23" (58 cm)		1252-2023-00H	

## STEP 2: SCEGLI IL KIT DI MONTAGGIO

✓	CODICE	IMMAGINE	TIPO	€
[ ]	1259-2400-100		Quad Quick Release	-

✓	CODICE	IMMAGINE	TIPO	€
[ ]	1259-2405-100		Heavy Duty	40

## Opzioni per schienali e supporti tronco

Q.TA'	CODICE	KIT DI INSERTI	€	Q.TA'	CODICE	KIT DI INSERTI	€
	1209-2713-300	Cunei addizionali lombari e per stabilità laterale	57		1209-2720-300	Kit di cunei	130
	1209-2722-300	Cuneo asimmetrico lungo 20 cm, largo 10 cm, spessore 4 cm	50		1209-2724-300	Cuneo a 5° lungo 55 cm, largo 50 cm, spessore 4,4 cm	79
	1209-2723-300	Cuneo biangolare lungo 20 cm, largo 10 cm, spessore 4 cm	57		<b>1259-2452-100</b>	Kit estensione per attacchi Quad (per incrementare la profondità di seduta)	142
	<b>1259-2450-100</b>	Kit per attacchi Quad per incrementare l'inclinazione di circa 10°	70		<b>1266-2420-100</b>	Prolunga di 30 mm (in profondità) per staffa pelotta swing away o axial (NON Kidz)	60
	<b>1266-2411-100</b> <b>1266-2412-100</b>	Attacco pelotta tubo carrozzina (sinistro) Attacco pelotta tubo carrozzina (destra)	91		<b>1266-2430-100</b>	Prolunga di 115 mm (in profondità) per staffa pelotta swing away o axial (NON Kidz)	91

# Supporti per il tronco

## STEP 1: SCEGLI I SUPPORTI

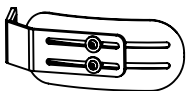

FISSI - € 142 al pezzo

Q.TA'	TIPO	CODICE
	Fissa 	<b>1266-2101-100</b>

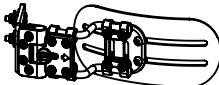
SWING-AWAY AXIAL - € 346 al pezzo

Q.TA'	TIPO	CODICE
	Axial 	<b>1266-2301-100</b>

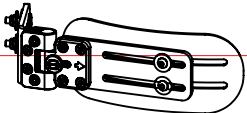
SWING-AWAY - € 244 al pezzo

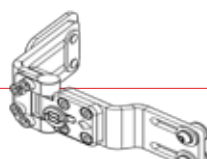
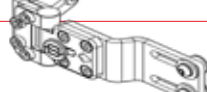
Q.TA'	TIPO	CODICE
	Dritta (Lunghezza totale 175 mm) 	<b>1266-2201-100</b>
	Dritta allungata (Lunghezza totale 205 mm) 	<b>1266-2202-100</b>
	Offset 20mm 	<b>1266-2203-100</b>
	Offset 40mm 	<b>1266-2204-100</b>

KIDS SWING AWAY MONO AXIAL

€ 239 al pz



Q.TA'	TIPO	CODICE
	Kids Mono Axial Destro	<b>1266-2623-100-R</b>
	Kids Mono Axial Sinistro	<b>1266-2623-100-L</b>
	Kids Mono Axial staffa su tubi carrozzina Destro	1266-2623-300-R
	Kids Mono Axial staffa su tubi carrozzina Sinistro	1266-2623-300-L
	Kids Mono Axial montaggio anteriorizzato Destro	1266-2623-200-R
	Kids Mono Axial montaggio anteriorizzato Sinistro	1266-2623-200-L

## STEP 2: SCEGLI LE PELOTTE (gratuite se acquistate insieme ai relativi supporti)

Q.TA'	TIPO	ALTEZZA	PROF.	CODICE	IMMAGINE
	Curva 1	95 mm	145 mm	<b>1266-3021-400</b>	
	Curva 2	95 mm	180 mm	<b>1266-3022-400</b>	
	Curva 3	115 mm	210 mm	<b>1266-3023-400</b>	
	Curva 4	115 mm	240 mm	<b>1266-3024-400</b>	
	Larga 1	105 mm	130 mm	<b>1266-3031-400</b>	
	Larga 2	125 mm	140 mm	<b>1266-3032-400</b>	
	Larga 3	140 mm	150 mm	<b>1266-3033-400</b>	
	Larga 4	160 mm	155 mm	<b>1266-3034-400</b>	
	Larga 5	195 mm	165 mm	<b>1266-3035-400</b>	
	Larga 6	230 mm	175 mm	<b>1266-3036-400</b>	

## Pelotta biangolare per il tronco

SWING-AWAY AXIAL - € 397 al pezzo

PELOTTA

(gratuita se acquistata insieme al relativo supporto)

Q.TA'	CODICE
	<b>1266-2501-100</b>

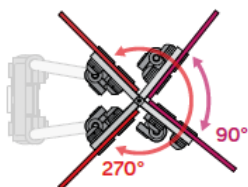

Q.TA'	TIPO	CODICE
	Pelotta biangolare tg. 4 (165x175 mm)	<b>1266-3044-410</b>
	Pelotta biangolare tg. 6 (215x195 mm)	<b>1266-3046-410</b>
	Pelotta biangolare tg. 8 (265x195mm)	<b>1266-3048-410</b>

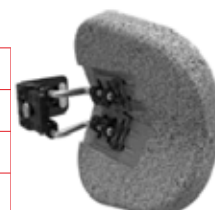

# Stabilizzatori pettorali

	TG:	Q.TA'	CODICE	MIS (1)	MIS (2)	MIS (3)	LARGH. NOM.	€
<b>AD "H"</b> (includere guide spalle e attacchi posteriori)	XS		1409-6640-017 + <b>1400-6692-000</b>		27 cm		8-12"	222
	S		<b>1409-6641-017 + 1400-6692-000</b>		30 cm		11-15"	
	M		<b>1409-6642-017 + 1400-6692-000</b>		36 cm		14-17"	
	L		<b>1409-6643-017 + 1400-6692-000</b>		42 cm		17-20"	
	XL		<b>1409-6644-017 + 1400-6692-000</b>		48 cm		20" +	
<b>DIRITTO (RETRATTORI)</b> (includere guide spalle e attacchi posteriori)	S		<b>1409-6621-017 + 1400-6692-000</b>		32 cm		11-15"	192
	M		<b>1409-6622-017 + 1400-6692-000</b>		38 cm		14-17"	
	L		<b>1409-6623-017 + 1400-6692-000</b>		44 cm		17-20"	
	XL		1409-6624-017 + <b>1400-6692-000</b>		50 cm		20" +	
<b>A PETTORINA</b> (includere guide spalle e attacchi posteriori)	XS		1409-6610-017 + <b>1400-6692-000</b>	15 cm	24 cm	24 cm	8-12"	222
	S		<b>1409-6611-017 + 1400-6692-000</b>	20 cm	32 cm	32 cm	11-15"	
	M		<b>1409-6612-017 + 1400-6692-000</b>	26 cm	40 cm	40 cm	14-17"	
	L		1409-6613-017 + <b>1400-6692-000</b>	30 cm	48 cm	48 cm	17-20"	
<b>A SGANCIO CENTRALE</b> (includere guide spalle e attacchi posteriori)	XS		1409-6660-017 + <b>1400-6692-000</b>	23 cm	26 cm	22 cm	8-12"	253
	S		<b>1409-6661-017 + 1400-6692-000</b>	29 cm	36 cm	32 cm	11-15"	
	M		<b>1409-6662-017 + 1400-6692-000</b>	34 cm	40 cm	36 cm	14-17"	
	L		1409-6663-017 + <b>1400-6692-000</b>	40 cm	45 cm	42 cm	17-20"	
	XL		1409-6664-017 + <b>1400-6692-000</b>	45 cm	50 cm	50 cm	20" +	
<b>GUIDE PER LE SPALLE E ATTACCHI POSTERIORI</b>		[X]	<b>1400-6692-000</b>				(includere con gli stabilizzatori)	

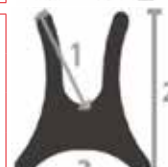
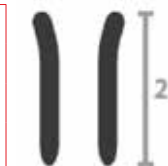

# Supporti per il capo Stylo

(completi di attacco allo schienale)



	TG.	LARGH.	ALTEZZA	Q.TA'	BRACCETTO 16 CM	€	Q.TA'	BRACCETTO 26 CM	€
<b>CONTOUR</b>	S	285 mm	115 mm		1275-0021-000 + 1274-1252-000	430		1275-0021-000 + 1274-1282-000	460
	L	340 mm	165 mm		1275-0022-000 + 1274-1252-000	430		1275-0022-000 + 1274-1282-000	460
<b>COMFI LATERAL</b>	STD	270 mm	150 mm		1275-0043-000 + 1274-1252-000	520		1275-0043-000 + 1274-1282-000	550
	EXT	270 mm	165 mm		1275-0044-000 + 1274-1252-000	520		1275-0044-000 + 1274-1282-000	550



Dimensioni interne Comfi Standard (supporto per il collo): larghezza 13 cm e profondità 7,5 cm  
Dimensioni interne Comfi Extended (supporto per il collo): larghezza 17 cm e profondità 16 cm

# Cinture Spex 2 e 4 punti

	TG:	Q.TA'	CODICE	Lunghezza imbottitura	Range di regolazione	LARGH. NOM.	€
Spex 2 Point Padded Hip Belt, Centre Pull, Pen Popper	S		1405-6211-025	36 cm	28,1 cm - 38,4 cm	11-15"	159
	M		1405-6212-025	46 cm	35,8 cm - 43,5 cm	14-17"	
	L		1405-6213-025	56 cm	43,5 - 51,2 cm	17-20"	



Spex 2 Point Padded Hip Belt, Centre Pull, Side Release	S		1405-6211-027	36 cm	28,1 cm - 38,4 cm	11-15"	106
	M		1405-6212-027	46 cm	35,8 cm - 43,5 cm	14-17"	
	L		1405-6213-027	56 cm	43,5 - 51,2 cm	17-20"	



Spex 2 Point Padded Hip Belt, Dual Centre Pull, Side Release	S		1405-6221-027	36 cm	28,1 cm - 38,4 cm	11-15"	106
	M		1405-6222-027	46 cm	35,8 cm - 43,5 cm	14-17"	
	L		1405-6223-027	56 cm	43,5 - 51,2 cm	17-20"	



	TG:	Q.TA'	CODICE	Lunghezza imbottitura	Range di regolazione	LARGH. NOM.	€
Spex 4 Point Padded Hip Belt, Centre Pull, Side Release	S		1406-6411-027	36 cm	28,1 cm - 38,4 cm	11-15"	138
	M		1406-6412-027	46 cm	35,8 cm - 43,5 cm	14-17"	
	L		1406-6413-027	56 cm	43,5 - 51,2 cm	17-20"	



Spex 4 Point Padded Hip Belt, Dual Centre Pull, Side Release	S		1406-6421-027	36 cm	28,1 cm - 38,4 cm	11-15"	138
	M		1406-6422-027	46 cm	35,8 cm - 43,5 cm	14-17"	
	L		1406-6423-027	56 cm	43,5 - 51,2 cm	17-20"	



Spex 4 Point Padded Hip Belt, Side Pull, Pen Popper	S		1406-6401-025	36 cm	28,1 cm - 38,4 cm	11-15"	216
	M		1406-6402-025	46 cm	35,8 cm - 43,5 cm	14-17"	
	L		1406-6403-025	56 cm	43,5 - 51,2 cm	17-20"	



Spex 4 Point Padded Hip Belt, Side Pull, Side Release	S		1406-6401-027	36 cm	28,1 cm - 38,4 cm	11-15"	138
	M		1406-6402-027	46 cm	35,8 cm - 43,5 cm	14-17"	
	L		1406-6403-027	56 cm	43,5 - 51,2 cm	17-20"	



Spex 4 Point Padded Hip Belt, Centre Pull, Pen Popper	S		1406-6411-025	36 cm	28,1 cm - 38,4 cm	11-15"	216
	M		1406-6412-025	46 cm	35,8 cm - 43,5 cm	14-17"	
	L		1406-6413-025	56 cm	43,5 - 51,2 cm	17-20"	











# Poggiatesta Ottobock

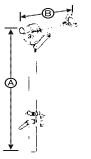

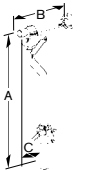
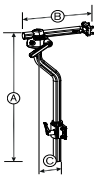
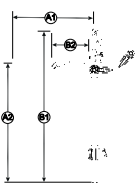
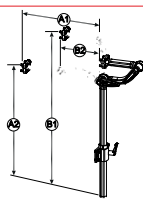
Advanced line						
Codice		Figura	Descrizione	Mis.	Dimensioni [mm]	Quantità
476L52=SK100	<input type="checkbox"/>		Comfort Plus	N	A = 150, B = 110, C = 60	
476L52=SK105	<input type="checkbox"/>			S	A = 200, B = 140, C = 60	
476L52=SK110	<input type="checkbox"/>			M	A = 250, B = 150, C = 60	
476L52=SK115	<input type="checkbox"/>			L	A = 360, B = 150, C = 60	
476L52=SK120	<input type="checkbox"/>		Tri-Comfort Plus	XS	A = 200, B = 110, C = 80, D = 100	
476L52=SK125	<input type="checkbox"/>			NS	A = 220, B = 140, C = 90, D = 120	
476L52=SK130	<input type="checkbox"/>			S	A = 290, B = 150, C = 100, D = 160	
476L52=SK135	<input type="checkbox"/>			M	A = 360, B = 150, C = 130, D = 170	
476L52=SK140	<input type="checkbox"/>		Adjustable Comfort Plus	M	A = 60, B = 130, C = 130, D = 130	
476L52=SK145	<input type="checkbox"/>			L	A = 60, B = 130, C = 180, D = 170	
476L52=SK150	<input type="checkbox"/>		Combo	S	A = 50, B = 80, C = 80, D = 130, E = 70	
476L52=SK155	<input type="checkbox"/>			L	A = 70, B = 100, C = 120, D = 150, E = 90	
476L52=SK160	<input type="checkbox"/>			XL	A = 160, B = 160, C = 180, D = 150, E = 160	

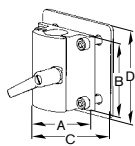
Care line						
Codice		Figura	Descrizione	Mis.	Dimensioni [mm]	Quantità
430H1=1-7	<input type="checkbox"/>		Poggiatesta standard	Large	A = 290, B = 150, C = 50	
430H1=3-7	<input type="checkbox"/>			Small	A = 250, B = 100, C = 50	
430C1=1-7	<input type="checkbox"/>		Poggiatesta / poggianuca	Large	A = 220, B = 130, C = 90	
430C1=3-7	<input type="checkbox"/>			Small	A = 180, B = 115, C = 55	
430C2=1-7	<input type="checkbox"/>		Poggiatesta / poggianuca con alette	Large	A = 220, B = 130, C = 130	
430C2=3-7	<input type="checkbox"/>			Small	A = 180, B = 115, C = 90	
430C3=1-7	<input type="checkbox"/>		Poggiatesta ad X	Large	A = 220, B = 195, C = 160, D = 130	
430C4=1-7	<input type="checkbox"/>			Small	A = 203, B = 147, C = 110, D = 85	



# Kit di montaggio Ottobock

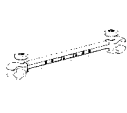

Codice	Figura	Descrizione	Dimensioni [mm]	Quantità
476L52=SK025		Kit di montaggio multi-assiale, diritto, nero, 25mm da combinare ai poggiatesta della linea CareLine	A = 400; B = 200	
476L52=SK026		Kit di montaggio multi-assiale, diritto, nero, 17mm da combinare ai poggiatesta della linea Advanced Line	A = 400; B = 190	
476L52=SK015		Kit di montaggio multi-assiale, curvo, nero, 25mm da combinare ai poggiatesta della linea CareLine	A = 400; B = 200; C = 70	
476L52=SK016		Kit di montaggio multi-assiale, curvo, nero, 17 mm da combinare ai poggiatesta della linea Advanced Line	A = 400; B = 200; C = 70	
476L52=SK035		Kit di montaggio "a collo d'oca" nero, da combinare ai poggiatesta della linea CareLine	A1 = 273; A2 = 390; B1 = 512; B2 = 140,7	
476L52=SK036		Kit di montaggio "a collo d'oca" nero, da combinare ai poggiatesta della linea Advanced Line	A1 = 263; A2 = 390; B1 = 512; B2 = 130	
477L52=ST170		Adattatore ad anello 17mm		
477L52=SK055		Kit montaggio della staffa allo schienale, per staffe multiassiali e "a collo d'oca" (non in combinazione con kit di montaggio 476D52=SK0xx presenti alla pagina successiva)	A = 63,5; B = 63,5; C = 80,0; D = 80,0	
476L52=SK165		Staffa UniLink corta, da abbinare ai poggiatesta Advanced Line (necessario il kit di montaggio 476L52=SK170)	A = 178, B = 76	
476L52=SK175		Staffa UniLink lunga, da abbinare ai poggiatesta Advanced Line (necessario il kit di montaggio 476L52=SK170)	A = 305, B = 76	
476L52=SK170		Kit di montaggio allo schienale per staffe UniLink		

Codice	Figura	Descrizione	Dimensioni [mm]	Quantità
477L52=ST165	<input type="checkbox"/>		A = 38	
477L52=ST166	<input type="checkbox"/>		A = 50	
477L52=ST167	<input type="checkbox"/>		A = 76	
491L75=ST010	<input type="checkbox"/>		Adattatore mont. staffa poggiatesta su sedile standard per carrozzine Juvo B4/B5/B6	
491L75=ST012	<input type="checkbox"/>		Adattatore mont. staffa poggiatesta su sedile VAS per carrozzine Juvo B5/B6	







Codice	Figura	Descrizione	Largh. seduta carr. [mm]	Quantità
476D52=SK035 <sup>1</sup>	<input type="checkbox"/>		170 – 420	
476D52=SK045	<input type="checkbox"/>		400 – 540	
476D52=SK055	<input type="checkbox"/>		520 – 630	
476D52=SK085	<input type="checkbox"/>		310 – 370	
476D52=SK065	<input type="checkbox"/>		380 – 420	
476D52=SK015	<input type="checkbox"/>		430 – 530	
476D52=SK025	<input type="checkbox"/>		540 – 640	

<sup>1</sup> Nota: per il kit di montaggio 476D52=SK035, usare solo i morsetti piccoli 477D52=SK0xx indicati qui di seguito.

#### Morsetti di fissaggio

Codice	Figura	Descrizione	Diametro tubi Ø [mm]	Quantità
434H1=3/4-7	<input type="checkbox"/>		Ø 19,0	
434H1=7/8-7	<input type="checkbox"/>		Ø 22,2	
434H1=1-7	<input type="checkbox"/>		Ø 25,0	
477D52=SK036	<input type="checkbox"/>		Ø 19,0	
477D52=SK042	<input type="checkbox"/>		Ø 22,2	
477D52=SK030	<input type="checkbox"/>		Ø 25,0	

## Cinghie pelviche Ottobock

Codice	Figura	Descrizione	Dimensioni [mm]	Quantità
476P52=SK004	<input type="checkbox"/>		A 2 punti con fibbia in plastica	H: 40, Lu: 2000
476P52=SK002	<input type="checkbox"/>		A 2 punti con fibbia in metallo	H: 40, Lu: 2000
476P52=SK006	<input type="checkbox"/>		A 2 punti con fibbia in plastica, per bambini	H: 25, Lu: 2000
476P52=SK003	<input type="checkbox"/>		A 4 punti con fibbia in plastica	H: 40, Lu: 2000
476P52=SK001	<input type="checkbox"/>		A 4 punti con fibbia in metallo	H: 40, Lu: 2000
476P52=SK005	<input type="checkbox"/>		A 4 punti con fibbia in plastica, per bambini	H: 25; Lu: 1000