



Avantgarde 4

Manuele actieve rolstoel
480F160=0_AA01_C

ottobock.

Order NR: _____

Klant

Klant nr. _____

Naam _____

Straat + nr. _____

Postcode, stad _____

Verzendadres (indien anders dan klantadres)

Naam _____

Straat + nr. _____

Postcode, stad _____

Bedrijf _____

Naam _____ Datum _____ Handtekening _____

Offerte Bestelling



DV



DS

Basisprijs	
Avantgarde 4	€ 2.783,28
Alle prijzen in €, incl BTW	
Geldig: 01.01.2026 - 31.12.2026	
Prijswijzigingen, zet -en/of drukfouten voorbehouden	
Mail uw bestelling naar mbx@ottobock.com	

Standaard uitrusting

- Aluminium buisframe met enkele en dubbele kruisbrace
- Keuze uit voorframe-offset
 - > DS versie = vaste voetensteun
 - > DV versie = voetensteun wegzwenkbaar en afneembaar
- Aluminium voetensteun:
 - > Eindelijk of gedeelde voetplaat
- Naspanbare rugbekleding
- Aluminium kledingbeschermers
- Modulair design
- Aandrijfwielen met quick-release assen
- Kniehevelrem 4.0
- Kuitband
- Plooibaar, max. gebruikersgewicht 140 kg
- Crash-getest volgens ISO 7176-19 (met enkel en dubbel kruisframe)











Bij het plaatsen van de bestelling, accepteert u de instructies in de gebruikershandleidingen / servicehandleidingen voor accessoires en producten van andere fabrikanten, wanneer deze worden gecombineerd met een product van Ottobock, naast de instructies in de gebruikershandleidingen / servicehandleidingen van de betreffende Ottobock-producten. U bevestigt ook dat u onze algemene voorwaarden heeft gelezen, begrepen en geaccepteerd. Bovendien, bij het plaatsen van de bestelling, accepteert u dat, indien u wijzigingen of aanpassingen aanbrengt die niet voldoen aan de specificaties van de Ottobock-gebruikershandleidingen / servicehandleidingen, u zelf zorgt voor een conformiteitsbeoordeling in overeenstemming met de nationale eisen.

Code		Voorframe type	Prestatiecode	Prijs
MA01	<input type="checkbox"/>	DS 70° vaste voetensteun		-
MA03	<input type="checkbox"/>	DS 80° vaste voetensteun		-
MA000	<input type="checkbox"/>	DV afneembaar en wegzwenkbare voetensteun		-
Code		Voorframe offset	Prestatiecode	Prijs
MA14	<input type="checkbox"/>	0 cm offset		-
MA15	<input type="checkbox"/>	2 cm offset		-
Code		Uitrusting	Prestatiecode	Prijs
MA110	<input type="checkbox"/>	Standaard		-
Code		Design aandrijf wiel adapter	Prestatiecode	Prijs
MA113	<input type="checkbox"/>	Met verschillende instelmogelijkheden (ISO 7176-19)		-
MA114	<input type="checkbox"/>	Vast gelast (CLT optie)	€	308,15
Code		Kruisframe	Prestatiecode	Prijs
MA100	<input type="checkbox"/>	Enkel kruisframe (max gebruikersgewicht 100 kg, enkel zitbreedte 42 cm)		-
MA101	<input type="checkbox"/>	Dubbel kruisframe		-
Code		Type rolstoel	Prestatiecode	Prijs
	<input type="checkbox"/>	Standaard		
Code		Zitbreedte (ZB) in cm	Prestatiecode	Prijs
		<input type="checkbox"/> 32 <input type="checkbox"/> 34 <input type="checkbox"/> 36 <input type="checkbox"/> 38 <input type="checkbox"/> 40 <input type="checkbox"/> 42 <input type="checkbox"/> 44 <input type="checkbox"/> 46		
		<input type="checkbox"/> 48 <input type="checkbox"/> 50 <input type="checkbox"/> 52		
Code		Zitdiepte (ZD) in cm	Prestatiecode	Prijs
		<input type="checkbox"/> 36 <input type="checkbox"/> 38 <input type="checkbox"/> 40 <input type="checkbox"/> 42 <input type="checkbox"/> 44 <input type="checkbox"/> 46 <input type="checkbox"/> 48		
		<input type="checkbox"/> 50 <input type="checkbox"/> 52 <input type="checkbox"/> 54		
Code		Zithoogte vooraan (ZHV) in cm	Prestatiecode	Prijs
		<input type="checkbox"/> 38 <input type="checkbox"/> 39 <input type="checkbox"/> 40 <input type="checkbox"/> 41 <input type="checkbox"/> 42 <input type="checkbox"/> 43 <input type="checkbox"/> 44 <input type="checkbox"/> 45 <input type="checkbox"/> 46		
		<input type="checkbox"/> 47 <input type="checkbox"/> 48 <input type="checkbox"/> 49 <input type="checkbox"/> 50 <input type="checkbox"/> 51 <input type="checkbox"/> 52 <input type="checkbox"/> 53 <input type="checkbox"/> 54		
Code		Frame accessoires	Prestatiecode	Prijs
MA50	<input type="checkbox"/>	Transit wielen, paar	€	164,20
MA51	<input type="checkbox"/>	Kiep-hulp, rechts	€	116,23
MA52	<input type="checkbox"/>	Kiep-hulp, links	€	116,23
MA55	<input type="checkbox"/>	Anti-kiep wegzwenkbaar, rechts	222938 €	208,26
MA56	<input type="checkbox"/>	Anti-kiep wegzwenkbaar, links	222938 €	208,26
MA57	<input type="checkbox"/>	Stokhouder met kiep-hulp, rechts	€	91,70
MA58	<input type="checkbox"/>	Stokhouder met kiep-hulp, links	€	91,70
MA60	<input type="checkbox"/>	Frame bekleding/bescherming lang	€	69,31
MA60	<input type="checkbox"/>	Frame bekleding/bescherming kort	€	69,31

Code	Banden	Prestatiecode	Prijs
MG30	<input type="checkbox"/> Banden met witte zijanten (lucht) 1 3/8" ,24" (1)(2)(3)		€ -
MG31	<input type="checkbox"/> Schwalbe RightRun, fijn profiel, 1" 22", 24", 25" (3)		€ -
MG34	<input type="checkbox"/> PU 1", 24" (1)(3)		€ -
MG341	<input type="checkbox"/> PU 1" Black, 24" (1)(3)		€ -
MG37	<input type="checkbox"/> Schwalbe Marathon Plus Evolution, 1" 22", 24", 25"		€ 133,28
MG200	<input type="checkbox"/> Schwalbe ONE 1" (CLT optie) 24" (3)		€ 140,75
	(1) Niet in combinatie met MG15, MG150		
	(2) Niet in combinatie met MG10, MG11, MG12		
	(3) Niet in combinatie met MG 197, MG198, MG199		
Code	Hoepels (PER PAAR)	Prestatiecode	Prijs
MG50	<input type="checkbox"/> Aluminium, zwart gecoat 22", 24", 25"		€ -
MG52	<input type="checkbox"/> Aluminium, zilver geanodiseerd, hoog 22", 24", 25"		€ -
MG53	<input type="checkbox"/> Aluminium, zilver geanodiseerd, laag 22", 24"		€ -
MG54	<input type="checkbox"/> Aluminium, rubber-coated 22", 24", 25"	222953	€ 235,60
MG56	<input type="checkbox"/> Roestvrij staal gepolijst, hoog 22", 24", 25"		€ 69,31
MG57	<input type="checkbox"/> Roestvrij staal gepolijst, laag 22", 24"		€ 69,31
MG63	<input type="checkbox"/> Curve L, geanodiseerd 24", 25"		€ 425,43
MG64	<input type="checkbox"/> Curve L Grip 24", 25"	222953	€ 460,66
MG65	<input type="checkbox"/> Gekko, ergonomische handrem 24", 25"		€ 456,38
Code	Montage hoepels	Prestatiecode	Prijs
MG70	<input type="checkbox"/> Smal (15 mm)		€ -
MG71	<input type="checkbox"/> Wijd (25 mm)		€ -
Code	Wielbasisverlenging inclusief remadapter	Prestatiecode	Prijs
MG86	<input type="checkbox"/> Extra lang		€ 328,41
MG82	<input type="checkbox"/> Extra lang met tweede as (voor aanpassing handbike)		€ 285,75
MG46	<input type="checkbox"/> Zonder		€ -
Code	Quick-release systeem	Prestatiecode	Prijs
MG27	<input type="checkbox"/> Quick-release as		€ -
MG28	<input type="checkbox"/> Quick-release as met Tetra ontgrendeling		€ 140,75
Code	Schokdemper	Prestatiecode	Prijs
MG97	<input type="checkbox"/> Hardheid "soft" (tot 60 kg) *		€ 474,48
MG98	<input type="checkbox"/> Hardheid "medium" (61 kg – 100 kg) *		€ 474,48
MG99	<input type="checkbox"/> Hardheid "hard" (101 kg – 140 kg) *		€ 474,48
	* Geen combinatie met MH82, MG86		
Code	Remmen	Prestatiecode	Prijs
MH01	<input type="checkbox"/> Knielevelrem 4.0		€ -
MH30	<input type="checkbox"/> Knielevelrem 4.0, lange remhendel		€ -
MH05	<input type="checkbox"/> Schaarrem (CLT optie)		€ 237,78
MH06	<input type="checkbox"/> Knielevelrem voor gebruiker en begeleider		€ 351,87
MH08	<input type="checkbox"/> Rem voor eenhandsaandrijving, rechts		€ 335,87
MH09	<input type="checkbox"/> Rem voor eenhandsaandrijving, links		€ 335,87

Code	Rem accessoires	Prestatiecode	Prijs
MH10	<input type="checkbox"/> Remhendelverlenging voor knielevelrem	221693	€ 45,36
MH21	<input type="checkbox"/> Verlenging wielvergrendelingshendel, opsteekbaar		€ 45,36
Code	Rughoogte (RH) in cm	Prestatiecode	Prijs
	<input type="checkbox"/> 25 <input type="checkbox"/> 27,5 <input type="checkbox"/> 30 <input type="checkbox"/> 32,5 <input type="checkbox"/> 35 <input type="checkbox"/> 37,5		
	<input type="checkbox"/> 40 <input type="checkbox"/> 42,5 <input type="checkbox"/> 45 <input type="checkbox"/> 47,5 <input type="checkbox"/> 50 <input type="checkbox"/> 52,5 <input type="checkbox"/> 55		
Code	Rugsysteem	Prestatiecode	Prijs
MD01	<input type="checkbox"/> Rugbuizen, hoogte-aanpasbaar, recht		€ -
	<input type="checkbox"/> RH 25 – 32,5 cm <input type="checkbox"/> RH 32,5 – 40 cm <input type="checkbox"/> RH 42,5 – 50 cm <input type="checkbox"/> RH 52,5 – 55 cm		
MD09	<input type="checkbox"/> Rugbuizen, hoogte-aanpasbaar, met lumbaal knik		€ -
	<input type="checkbox"/> RH 35 – 40 cm <input type="checkbox"/> RH 40 – 45 cm <input type="checkbox"/> RH 45 – 50 cm <input type="checkbox"/> RH 50 – 55 cm		
MD10	<input type="checkbox"/> Rugbuizen, hoek-aanpasbaar in stappen van 6° (-15 to +9°)		€ 380,01
	<input type="checkbox"/> RH 30 – 40 cm <input type="checkbox"/> RH 35 – 45 cm <input type="checkbox"/> RH 40 – 50 cm		
MD11	<input type="checkbox"/> Plooibaar naar achter, in het midden van de rugsteun		€ 241,02
MD12	<input type="checkbox"/> Vastgelaste rugsteun (niet goedgekeurd voor gebruik in voertuigen) (2)		€ 509,67
	<input type="checkbox"/> 0° <input type="checkbox"/> -5° <input type="checkbox"/> -10° <input type="checkbox"/> -15°		
	(2) Enkel in combinatie met MA114		
Code	Rugbekleding	Prestatiecode	Prijs
MD03	<input type="checkbox"/> Naspanbaar, gepolsterd		€ 55,44
MD05	<input type="checkbox"/> Naspanbaar, ademend		€ -
MD18	<input type="checkbox"/> Ultra light		€ 50,11
MD06	<input type="checkbox"/> Zonder		€ -
Code	Rugbekleding verbreding	Prestatiecode	Prijs
MD80	<input type="checkbox"/> + 2 cm		€ 26,65
MD81	<input type="checkbox"/> + 4 cm		€ 26,65
MD82	<input type="checkbox"/> Zonder		€ -
Code	Duwhandvatten	Prestatiecode	Prijs
MD50	<input type="checkbox"/> Kort		€ -
MD51	<input type="checkbox"/> Lang		€ -
MD52	<input type="checkbox"/> Telescopisch, lang		€ 196,18
MD55	<input type="checkbox"/> Hoogte verstelbaar/afneembaar		€ 196,18
MD56	<input type="checkbox"/> Neerklapbaar (max. gebruikersgewicht 125 kg)		€ 170,60
MD59	<input type="checkbox"/> Zonder		€ -
Code	Rug accessoires	Prestatiecode	Prijs
MD58	<input type="checkbox"/> Rugstabilisatiestang (enkel in combinatie met MD55)		€ 218,59
Code	Zijdelen (PER PAAR)	Prestatiecode	Prijs
ME01	<input type="checkbox"/> Met warmte-isolatie		€ -
ME02	<input type="checkbox"/> Met spatbord en warmte-isolatie		€ 65,04
ME04	<input type="checkbox"/> Met spatbord, carbon		€ 462,76
ME05	<input type="checkbox"/> Met armsteun in hoogte verstelbaar, kort	220853	€ 368,60
ME06	<input type="checkbox"/> Met armsteun in hoogte verstelbaar, lang	220853	€ 368,60
ME17	<input type="checkbox"/> Zijpaneel met lange armsteun in hoogte verstelbaar	220853	€ 368,60

Code		Zijdeel accessoires	Prestatiecode	Prijs
ME50	<input type="checkbox"/>	Buisarmsteunen met arm pad, kort, per PAAR *	220853	€ 368,60
ME50	<input type="checkbox"/>	Buisarmsteunen met arm pad, lang, per PAAR *	220853	€ 368,60
ME50	<input type="checkbox"/>	Buisarmsteun extra hoog, lang 350mm, per PAAR *	220853	€ 368,60
		* Niet in combinatie met ME05, ME06, ME17		
ME60	<input type="checkbox"/>	Werkblad		€ 243,21
ME66	<input type="checkbox"/>	Werkblad, half zijdig <input type="checkbox"/> links <input type="checkbox"/> rechts		€ 243,21
		Voor meer opties, zie bestelbon accessoirelijst		
Code		Zitbekleding	Prestatiecode	Prijs
MC15	<input type="checkbox"/>	Zitbekleding met opbergvakjes		€ 79,00
MC16	<input type="checkbox"/>	Nylon zitbekleding, naspanbaar		€ -
MC18	<input type="checkbox"/>	Ultra light (CLT optie)		€ 50,11
MC06	<input type="checkbox"/>	Zonder		€ -
Code		Kussens (kortingen volgens accessoires lijst)	Prestatiecode	Prijs
MC20	<input type="checkbox"/>	Terra (hoogte 6 cm)	110518	€ 152,00
MC21	<input type="checkbox"/>	Terra aquos (hoogte 6 cm)		€ 244,48
MC22	<input type="checkbox"/>	Terra flair (hoogte 6 cm)	110555	€ 532,04
MC23	<input type="checkbox"/>	Cloud (hoogte 11 cm)	110577	€ 608,03
Code		Voetsteunen DV versie (afneembaar en wegzwenkbaar)	Prestatiecode	Prijs
MB010	<input type="checkbox"/>	Aluminium wegzwenkbare gedeelde voetsteunen, hoekverstelbaar (standaard)		€ -
MB100	<input type="checkbox"/>	Aluminium doorlopende voetplaat, hoekverstelbaar		€ -
MB70	<input type="checkbox"/>	Vergrendeling doorlopende voetsteun (voor MB100)		€ 93,83
MB120	<input type="checkbox"/>	Aluminium voetbeugel (buisvorm), hoekverstelbaar		€ -
MB74	<input type="checkbox"/>	Kunststof voetplaat voor voetbeugel (MB120)		€ 52,24
MB150	<input type="checkbox"/>	Doorlopende voetplaat voor korte onderbeenlengte		€ 201,52
MB25	<input type="checkbox"/>	Comfort beensteun per paar	220676	€ 349,62
MB26	<input type="checkbox"/>	Comfort beensteun links	220676	€ 174,81
MB27	<input type="checkbox"/>	Comfort beensteun rechts	220676	€ 174,81
MB85	<input type="checkbox"/>	STEALTH Amputatiesteun links		€ 356,47
MB86	<input type="checkbox"/>	STEALTH Amputatiesteun rechts		€ 356,47
MB87	<input type="checkbox"/>	STEALTH Amputatiesteun paar		€ 712,94
MB80	<input type="checkbox"/>	Zonder voetplaat		€ -
Code		Voetsteun opties DS versie (vast)	Prestatiecode	Prijs
MB100	<input type="checkbox"/>	Aluminium doorlopende voetplaat, hoekverstelbaar (standaard)		€ -
MB201	<input type="checkbox"/>	Wegzwenkbaar eendelige voetplaat naar links		€ 50,11
MB202	<input type="checkbox"/>	Wegzwenkbaar eendelige voetplaat naar rechts		€ 50,11
MB70	<input type="checkbox"/>	Vergrendeling doorlopende voetplaat (voor MB100)		€ 93,83
MB010	<input type="checkbox"/>	Aluminium gedeelde voetsteunen, hoekverstelbaar		€ -
MB120	<input type="checkbox"/>	Aluminium voetbeugel (buisvorm), hoekverstelbaar		€ -

MB150	<input type="checkbox"/>	Doorlopende voetplaat voor korte onderbeenlengte	€	201,52
Code Onderbeenlengte in cm (zonder zitkussen) Prestatiecode Prijs				
		Onderbeenlengte (OL) in cm (instelbereik 16 cm – 55 cm)		
Code Lengte van de voetsteunbuis (zonder zitkussen) Prestatiecode Prijs				
MB40	<input type="checkbox"/>	Kort	€	-
MB41	<input type="checkbox"/>	Medium	€	-
MB42	<input type="checkbox"/>	Lang	€	-
MB43	<input type="checkbox"/>	Extra lang	€	-
		Zie tabel E		
Code Overige accessoires Prestatiecode Prijs				
MZ51	<input type="checkbox"/>	Veiligheidsgordel met metalen sluiting	221354 €	88,77
Code Spaakbeschermers Prestatiecode Prijs				
MG90	<input type="checkbox"/>	Spaakschermen, transparant	€	158,87
MG100	<input type="checkbox"/>	Spaakschermen, Graphic decor	€	237,78
MG101	<input type="checkbox"/>	Spaakschermen, Miracle decor	€	237,78
MG102	<input type="checkbox"/>	Spaakschermen, Network decor	€	237,78
MG103	<input type="checkbox"/>	Spaakschermen, Robots decor	€	237,78
MG104	<input type="checkbox"/>	Spaakschermen, Spectrum decor	€	237,78
Code Frame kleuren Prestatiecode Prijs				
002	 <input type="checkbox"/>	Anthracite metallic		-
003	 <input type="checkbox"/>	Jet black RAL 9005		-
023	 <input type="checkbox"/>	White RAL 9016		-
048	 <input type="checkbox"/>	Obsidian black (textuur)		-
051	 <input type="checkbox"/>	Sunny orange (textuur)		-
057	 <input type="checkbox"/>	Forest Green		-
058	 <input type="checkbox"/>	Mint Green		-
059	 <input type="checkbox"/>	Raspberry		-
060	 <input type="checkbox"/>	Azure blue		-
001	 <input type="checkbox"/>	Briljant Silver		-
012	 <input type="checkbox"/>	Sky blue		-
014	 <input type="checkbox"/>	Candy red		-
027	 <input type="checkbox"/>	Shimano matte		-
056	 <input type="checkbox"/>	Pearl white		-
Code Speciale accessoires Prestatiecode Prijs				
MZ58	<input type="checkbox"/>	Tas voor aandrijfwielen	€	134,35
MZ92	<input type="checkbox"/>	Wheel blades (mini-skies voor zwenkwielen)	€	456,36
MZ93	<input type="checkbox"/>	Rugzak	€	69,31

Maten van de rolstoel

Zitbreedte (ZB) = buitenkant van de framebuis tot buitenkant van de framebuis

Zitdiepte (ZD) = voorkant van de zitbekleding tot de rugleuningbuis.

Voorste zithoogte (ZHV) = grond tot bovenkant van de zitbekleding

Achterste zithoogte (ZHA) = grond tot bovenkant van de zitbekleding.

Rugleuninghoogte (RH) = bovenkant van de zitbuis tot bovenkant van de rugleuningbekleding.

Onderbeenhoogte (OBL) = bovenkant van de zitbekleding tot bovenkant van de voetplaat.

Er geldt een fabricagetolerantie van 10 mm voor alle maten en van 10 % voor opgegeven gewichten.

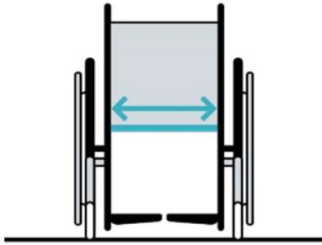

ZB= cm



ZD= cm

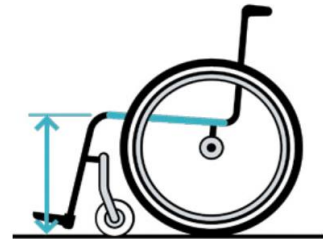

ZHV= cm



ZHA=

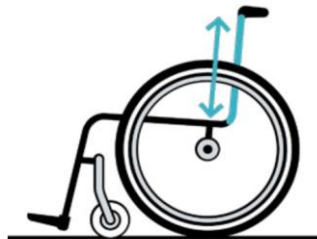

RH=



OBL= cm

A) Anterior seat height [ASH] / Caster Wheels

Caster wheels	4"	5"	5.5"	6"	7"
39.0 cm	●	●			
40.0 cm	●	●			
41.0 cm	●	●			
42.0 cm	●	●			
43.0 cm	●	●	●		
44.0 cm	●	●	●	●	
45.0 cm	●	●	●	●	●
46.0 cm	●	●	●	●	●
47.0 cm	●	●	●	●	●
48.0 cm	●	●	●	●	●
49.0 cm		●	●	●	●
50.0 cm	●	●	●	●	●
51.0 cm	●	●	●	●	●
52.0 cm	●	●	●	●	●
53.0 cm		●	●	●	●
54.0 cm			●	●	●
55.0 cm					●

● Position possible

The values indicated are rounded values which have been theoretically determined. Max. deviation of 1 cm.

The anterior seat height depends on the selected wheel size, caster fork and mounting position. Please refer to the seat height table! Specified without seat cushion at 0° seat inclination.

Horizontal position of the drive wheel attachment device: see sketch.

The posterior seat height (PSH) depends on the selected wheel size and mounting position in the drive wheel attachment device. Please refer to the seat height table!

A manufacturing tolerance of 10 mm applies to all measurements and of 10% to specified weights.

B) Posterior Seat Hight → Drive Wheel Size

Posterior seat height with wheelbase extension			
Axle position	Drive wheel size		
	22"	24"	25"
1	37 cm	39 cm	40 cm
2	40 cm	42 cm	42 cm
3	42 cm	44 cm	45 cm
4	46 cm	46 cm	48 cm
5	47 cm	49 cm	50 cm
Posterior seat height with shock absorber system			
Axle position	Drive wheel size		
	22"	24"	25"
1	40 cm	42 cm	43 cm
2	42 cm	44 cm	45 cm
3	44 cm	46 cm	47 cm
4	46 cm	48 cm	49 cm
5	48 cm	50 cm	51 cm

Posterior seat height			
Free mounting positions	Drive wheel size		
	22"	24"	25"
1	36 cm	38 cm	40 cm
2	37 cm	39 cm	41 cm
3	38 cm	40 cm	42 cm
4	39 cm	41 cm	43 cm
5	40 cm	42 cm	44 cm
6	41 cm	43 cm	45 cm
7	42 cm	44 cm	46 cm
8	43 cm	45 cm	47 cm
9	44 cm	46 cm	48 cm
10	45 cm	47 cm	49 cm
11	46 cm	48 cm	50 cm
12	47 cm	49 cm	51 cm

This table is for information only. The locking position may deviate in certain constellations. The locking position is selected such that the applicable rear seat height in the ordered constellation is reached as ordered.

C) Seat Depth [SD] / Horizontal Drive Wheel Position

Horizontal drive wheel position A															
Seat depth [cm]	Drive wheel size 22"					Drive wheel size 24"					Drive wheel size 25"				
	Caster wheels														
	4"	5"	5.5"	6"	7"	4"	5"	5.5"	6"	7"	4"	5"	5.5"	6"	7"
36.0	●	●	●	●	●	●	●	●	●	●	●	●	●	●	
38.0	●	●	●	●	●	●	●	●	●	●	●	●	●	●	
40.0	●	●	●	●	●	●	●	●	●	●	●	●	●	●	
42.0	●	●	●	●	●	●	●	●	●	●	●	●	●	●	
44.0	●	●	●	●	●	●	●	●	●	●	●	●	●	●	
46.0	●	●	●	●	●	●	●	●	●	●	●	●	●	●	
48.0	●	●	●	●	●	●	●	●	●	●	●	●	●	●	
50.0	●	●	●	●	●	●	●	●	●	●	●	●	●	●	
52.0	●	●	●	●	●	●	●	●	●	●	●	●	●	●	

Horizontal drive wheel position B															
Seat depth [cm]	Drive wheel size 22"					Drive wheel size 24"					Drive wheel size 25"				
	Caster wheels														
	4"	5"	5.5"	6"	7"	4"	5"	5.5"	6"	7"	4"	5"	5.5"	6"	7"
36.0	●	●	●												
38.0	●	●	●			●									
40.0	●	●	●	●		●	●	●	●		●	●	●	●	
42.0	●	●	●	●	●	●	●	●	●	●	●	●	●	●	
44.0	●	●	●	●	●	●	●	●	●	●	●	●	●	●	
46.0	●	●	●	●	●	●	●	●	●	●	●	●	●	●	
48.0	●	●	●	●	●	●	●	●	●	●	●	●	●	●	
50.0	●	●	●	●	●	●	●	●	●	●	●	●	●	●	
52.0	●	●	●	●	●	●	●	●	●	●	●	●	●	●	

Horizontal drive wheel position C															
Seat depth [cm]	Drive wheel size 22"					Drive wheel size 24"					Drive wheel size 25"				
	Caster wheels														
	4"	5"	5.5"	6"	7"	4"	5"	5.5"	6"	7"	4"	5"	5.5"	6"	7"
36.0	●	●				●	●				●	●			
38.0	●	●	●	●		●	●				●	●			
40.0	●	●	●	●		●	●				●	●			
42.0	●	●	●	●	●	●	●				●	●			
44.0	●	●	●	●	●	●	●	●	●	●	●	●	●	●	●
46.0	●	●	●	●	●	●	●	●	●	●	●	●	●	●	●
48.0	●	●	●	●	●	●	●	●	●	●	●	●	●	●	●
50.0	●	●	●	●	●	●	●	●	●	●	●	●	●	●	●
52.0	●	●	●	●	●	●	●	●	●	●	●	●	●	●	●

Horizontal drive wheel position D															
Seat depth [cm]	Drive wheel size 22"					Drive wheel size 24"					Drive wheel size 25"				
	Caster wheels														
	4"	5"	5.5"	6"	7"	4"	5"	5.5"	6"	7"	4"	5"	5.5"	6"	7"
36.0															
38.0	●	●	●	●											
40.0	●	●	●	●		●	●	●							
42.0	●	●	●	●	●	●	●	●			●	●	●		
44.0	●	●	●	●	●	●	●	●	●	●	●	●	●	●	●
46.0	●	●	●	●	●	●	●	●	●	●	●	●	●	●	●
48.0	●	●	●	●	●	●	●	●	●	●	●	●	●	●	●
50.0	●	●	●	●	●	●	●	●	●	●	●	●	●	●	●
52.0	●	●	●	●	●	●	●	●	●	●	●	●	●	●	●

Horizontal drive wheel position E															
Seat depth [cm]	Drive wheel size 22"					Drive wheel size 24"					Drive wheel size 25"				
	Caster wheels														
	4"	5"	5.5"	6"	7"	4"	5"	5.5"	6"	7"	4"	5"	5.5"	6"	7"
36.0															
38.0															
40.0	●	●	●	●	●										
42.0	●	●	●	●	●	●	●								
44.0	●	●	●	●	●	●	●	●	●		●	●	●	●	
46.0	●	●	●	●	●	●	●	●	●		●	●	●	●	
48.0	●	●	●	●	●	●	●	●	●	●	●	●	●	●	●
50.0	●	●	●	●	●	●	●	●	●	●	●	●	●	●	●
52.0	●	●	●	●	●	●	●	●	●	●	●	●	●	●	●

Horizontal drive wheel position F															
Seat depth [cm]	Drive wheel size 22"					Drive wheel size 24"					Drive wheel size 25"				
	Caster wheels														
	4"	5"	5.5"	6"	7"	4"	5"	5.5"	6"	7"	4"	5"	5.5"	6"	7"
36.0															
38.0															
40.0															
42.0	●	●	●	●	●										
44.0	●	●	●	●	●	●	●								
46.0	●	●	●	●	●	●	●	●	●	●	●	●	●		
48.0	●	●	●	●	●	●	●	●	●	●	●	●	●	●	●
50.0	●	●	●	●	●	●	●	●	●	●	●	●	●	●	●
52.0	●	●	●	●	●	●	●	●	●	●	●	●	●	●	●

Horizontal drive wheel position G																
Seat depth [cm]	Drive wheel size 22"					Drive wheel size 24"					Drive wheel size 25"					
	Caster wheels															
	4"	5"	5.5"	6"	7"	4"	5"	5.5"	6"	7"	4"	5"	5.5"	6"	7"	
36.0																
38.0																
40.0																
42.0	●	●	●	●	●											
44.0	●	●	●	●	●	●	●									
46.0	●	●	●	●	●	●	●	●			●	●	●			
48.0	●	●	●	●	●	●	●	●	●	●	●	●	●	●		
50.0	●	●	●	●	●	●	●	●	●	●	●	●	●	●	●	●
52.0	●	●	●	●	●	●	●	●	●	●	●	●	●	●	●	●

● possible position

D) Drive wheel position Distance from tipping point

Drive wheel position → Distance from tipping point in mm	
Dimension (horizontal) from centre axis to apex point Back support tube (front edge)/upholstery bar (top edge)	
Drive Wheel Position	Distance from tipping point
G (active)	133 mm
F	115.5 mm
E	98 mm
D	85 mm
C	67.5 mm
B	50 mm
A	32.5 mm (not with CLT version)

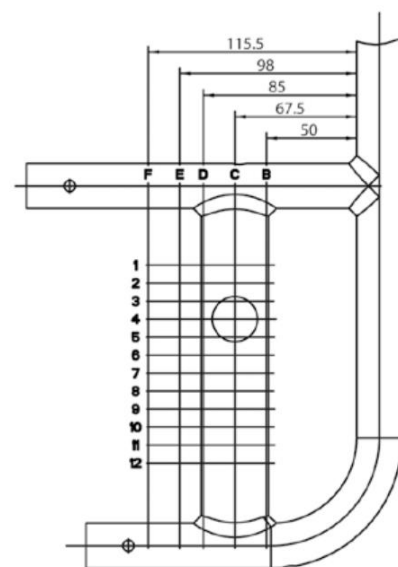
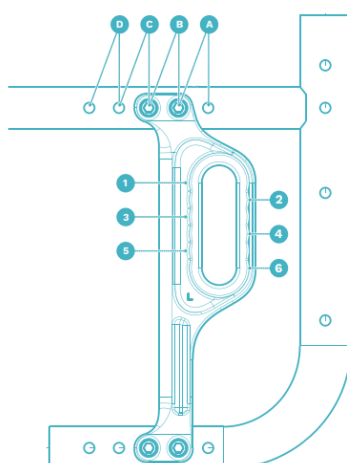
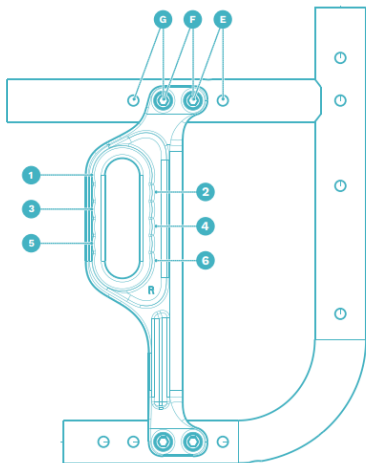
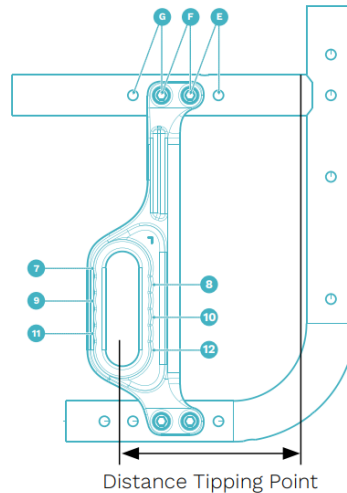

Drive wheel positions with CLT equipment

From position E, the drive wheel adapter must be turned around – right side to the left side and left side to the right side.

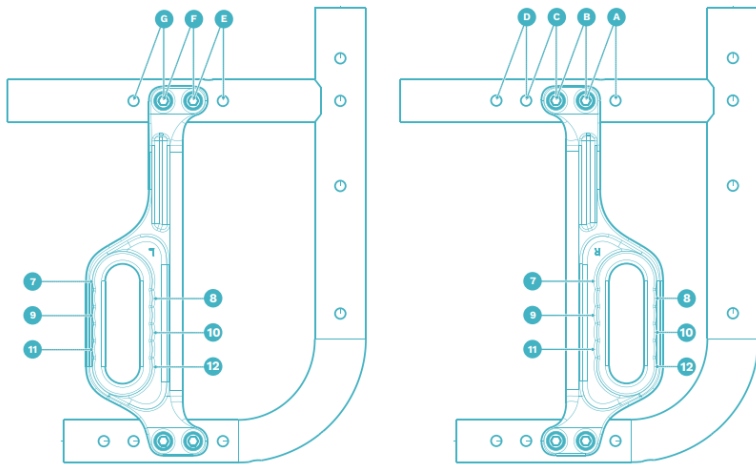

E) Lower Leg Length [LL] → Length Foot Plate Bar

Foot support bar	Lower leg length [cm]					
	Selection foot bar by 0 cm front frame offset				Selection foot bar by 2 cm front frame offset	
	Leg support single panel, leg support individual		Elevating leg support left or right	Elevating leg support, pair	Leg support single panel, leg support individual	
	Foot plate Aluminium	Foot plate plastic			Foot plate Aluminium	Foot plate plastic
Short	33 - 43	38 - 43	30 - 39	28 - 39	32 - 40	34 - 42
Medium	37 - 48	43 - 48	-	-	37 - 45	-
Long	42 - 52	47 - 52	35 - 51	35 - 51	42 - 50	46 - 53
Extra long	47 - 55	-	-	-	47 - 54	-



MA51/52
Tip-assist



MA55/56
Anti-tipper



MA57/58
Crutch holder



MF35/36/37
4" softroll caster, aluminium



MG10
Spinerogy SPOX



MG11
Spinerogy LX



MG83
One-arm drive



MG63
Curve L



MG65
Gekko



MG64
Curve L Grip



MG28
Tetra release



MH05
Scissor wheel lock

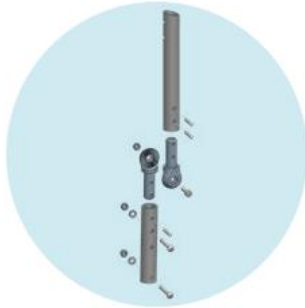

MD10
Back support, adjustable



MD11
Folding back support



MD55
Push handles, height adjustable/ detachable



MD56
Push handles, folding



ME50
Arm support padded, swing away



MC15
Seat upholstery with storage pockets



ME60
Tray



ME66
Half-sided tray

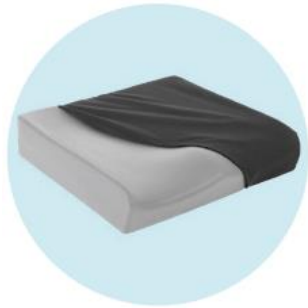

MC20
Terra



MC21
Terra Aquos

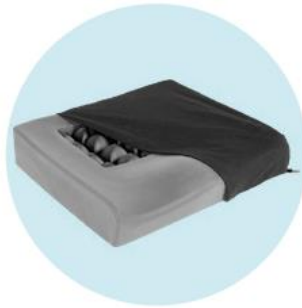

MC22
Terra Flair



MC23
Cloud



MB120
Tube bar



MB150
Single panel, short lower leg length



MB85/86/87
Stealth Amputation leg support



MG100
Graphics



MG101
Miracle



MG102
Network



MG103
Robots



MG104
Spectrum



MZ58
Bag for rear wheels



MZ93
Backpack