

Drawing Board - double

EP-SKS-DB2

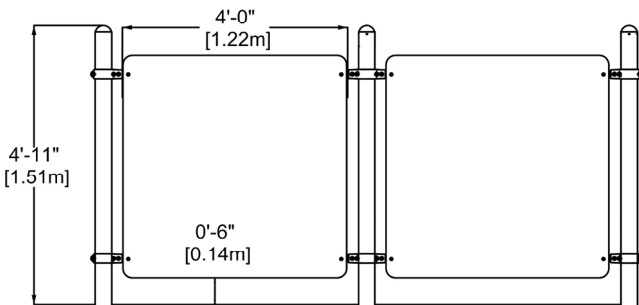
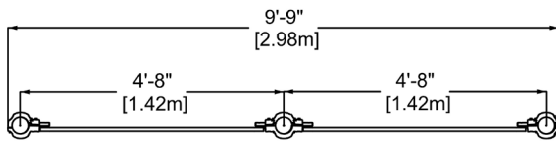
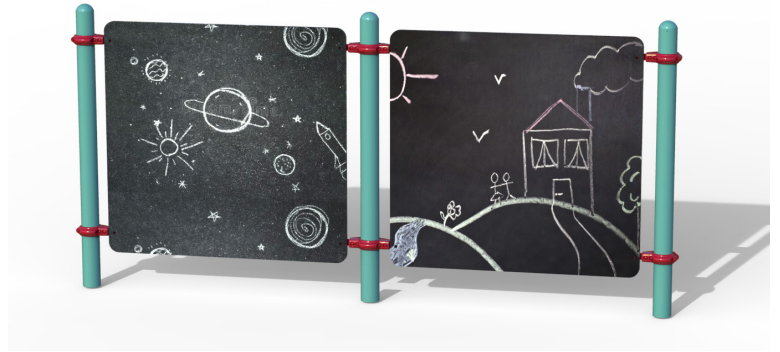

CHARACTERISTICS

Plastic drawing board with rounded corners that can be used on both sides.

Board dimensions: 4' x 4' (1.22m x 1.22m)

Center to center measure: 4'-8" (1.42m)

MATERIALS

Posts: 3 1/2" (89mm) galvanized powder coated steel.

Caps: powder coated aluminum.

Board: HDPE textured plastic 0.75" [19mm] thick.

INSTALLATION

Concrete poured into 12" (0.3m) diameter sonotubes. Depth to be determined according to the depth of the frost line in your region.

The concrete used for the foundations must be at least 25 Mpa at 28 days with entrained air.

Foundation backfill must be made of 0-3/4" aggregate in successive layers not exceeding 12in to reach 95% of the P.M.

PLAY VALUE

Can bonify an outdoor class, favorize creative games and lead towards calmer activities during recreations and playtime.

Designed to be used with classic chalk only. No liquid chalk markers.

INSTALLATION DETAILS

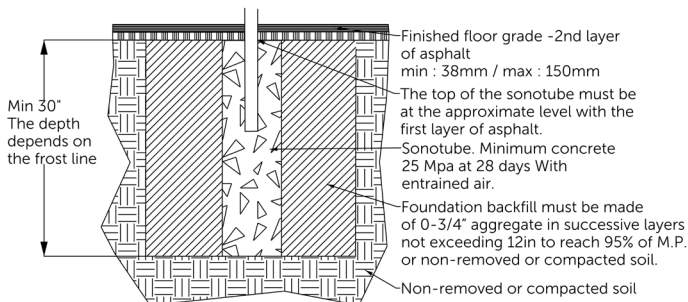

AVAILABLE COLORS - POSTS

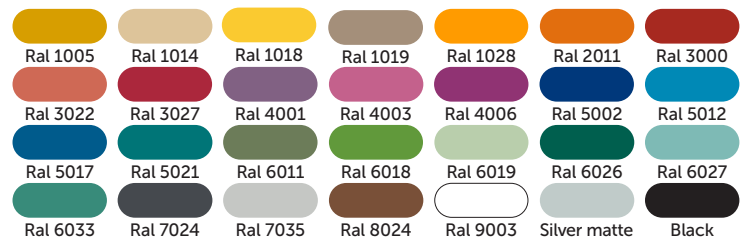

AVAILABLE COLOR - BOARD



Drawing Board - triple

EP-SKS-DB3



CHARACTERISTICS

Plastic drawing board with rounded corners that can be used on both sides.

Board dimensions: 4' x 4' (1.22m x 1.22m)

Center to center measure: 4'-8" (1.42m)

MATERIALS

Posts: 3 1/2" (89mm) galvanized powder coated steel.

Caps: powder coated aluminum.

Board: HDPE textured plastic 0.75" [19mm] thick.

INSTALLATION

Concrete poured into 12" (0.3m) diameter sonotubes. Depth to be determined according to the depth of the frost line in your region.

The concrete used for the foundations must be at least 25 Mpa at 28 days with entrained air.

Foundation backfill must be made of 0-3/4" aggregate in successive layers not exceeding 12in to reach 95% of the P.M.

PLAY VALUE

Can bonify an outdoor class, favorize creative games and lead towards calmer activities during recreations and playtime.

Designed to be used with classic chalk only. No liquid chalk markers.

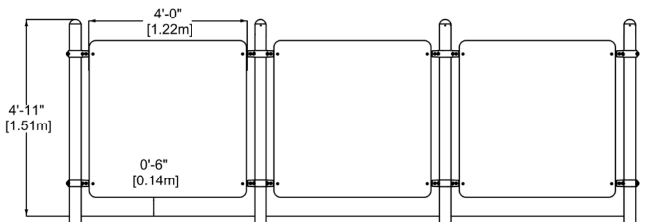
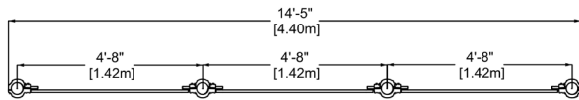

INSTALLATION DETAILS

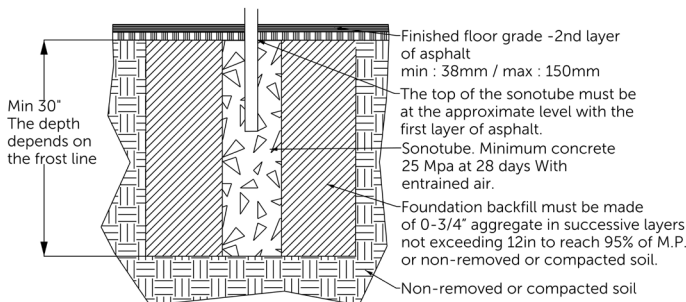

AVAILABLE COLORS - POSTS

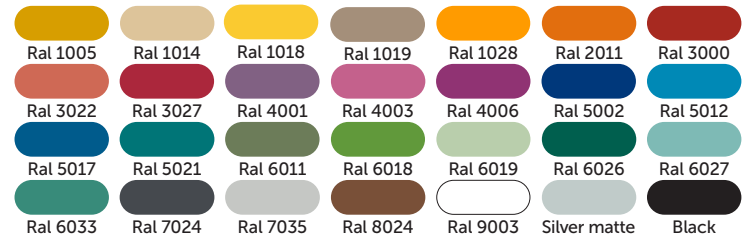

AVAILABLE COLOR - BOARD



Drawing Board - Quadruple

EP-SKS-DB4

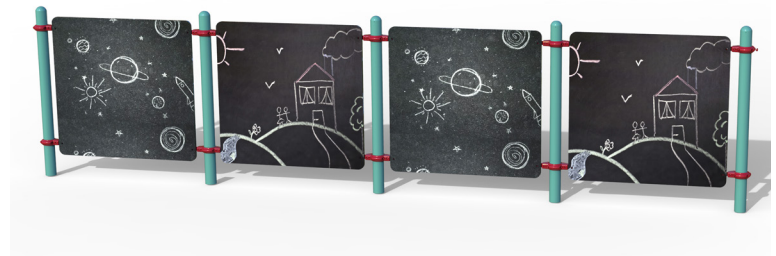

CHARACTERISTICS

Plastic drawing board with rounded corners that can be used on both sides.

Board dimensions: 4' x 4' (1.22m x 1.22m)

Center to center measure: 4'-8" (1.42m)

MATERIALS

Posts: 3 1/2" (89mm) galvanized powder coated steel.

Caps: powder coated aluminum.

Board: HDPE textured plastic 0.75" [19mm] thick.

INSTALLATION

Concrete poured into 12" (0.3m) diameter sonotubes. Depth to be determined according to the depth of the frost line in your region.

The concrete used for the foundations must be at least 25 Mpa at 28 days with entrained air.

Foundation backfill must be made of 0-3/4" aggregate in successive layers not exceeding 12in to reach 95% of the P.M.

PLAY VALUE

Can bonify an outdoor class, favorize creative games and lead towards calmer activities during recreations and playtime.

Designed to be used with classic chalk only. No liquid chalk markers.

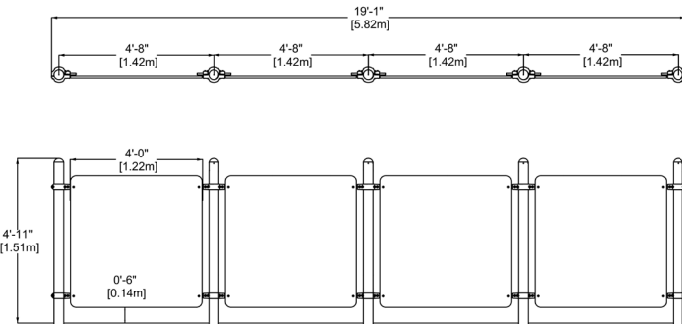

INSTALLATION DETAILS

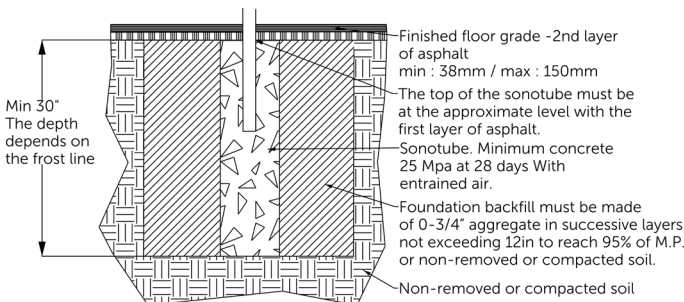

AVAILABLE COLORS - POSTS

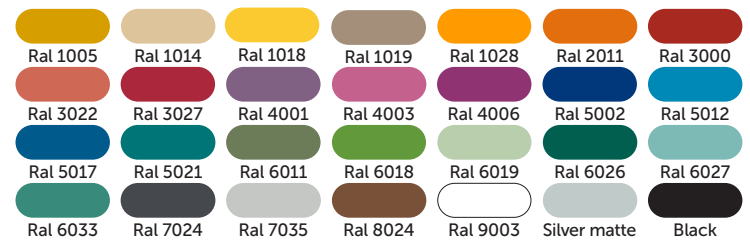

AVAILABLE COLOR - BOARD



Drawing Board - Quintuple

EP-SKS-DB5

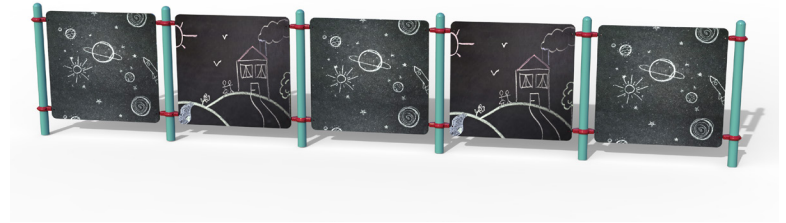

CHARACTERISTICS

Plastic drawing board with rounded corners that can be used on both sides.

Board dimensions: 4' x 4' (1.22m x 1.22m)

Center to center measure: 4'-8" (1.42m)

MATERIALS

Posts: 3 1/2" (89mm) galvanized powder coated steel.

Caps: powder coated aluminum.

Board: HDPE textured plastic 0.75" [19mm] thick.

INSTALLATION

Concrete poured into 12" (0.3m) diameter sonotubes. Depth to be determined according to the depth of the frost line in your region.

The concrete used for the foundations must be at least 25 Mpa at 28 days with entrained air.

Foundation backfill must be made of 0-3/4" aggregate in successive layers not exceeding 12in to reach 95% of the P.M.

PLAY VALUE

Can bonify an outdoor class, favorize creative games and lead towards calmer activities during recreations and playtime.

Designed to be used with classic chalk only. No liquid chalk markers.

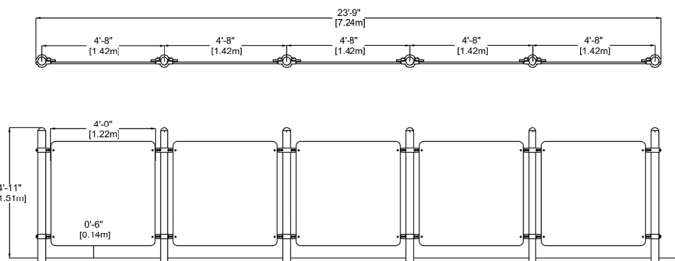

INSTALLATION DETAILS

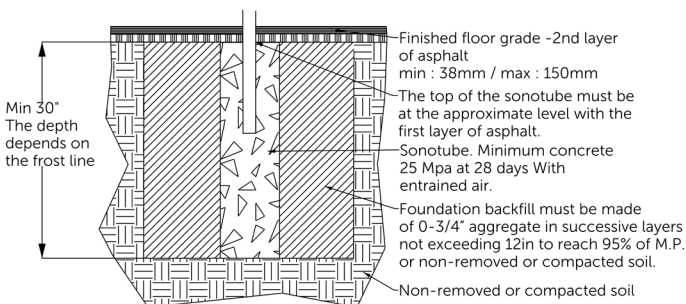

AVAILABLE COLORS - POSTS

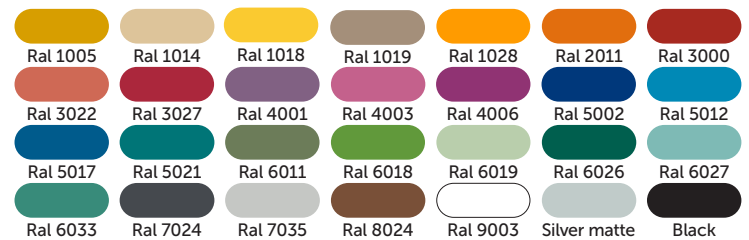

AVAILABLE COLOR - BOARD

