

KitchenAid®

QUICK START GUIDE

WELCOME
BIENVENUE
BIENVENIDOS

Scan for Quick Start



Scan here for set-up & how-to videos, recipes, care & maintenance, FAQ, warranty



QUICK START GUIDE

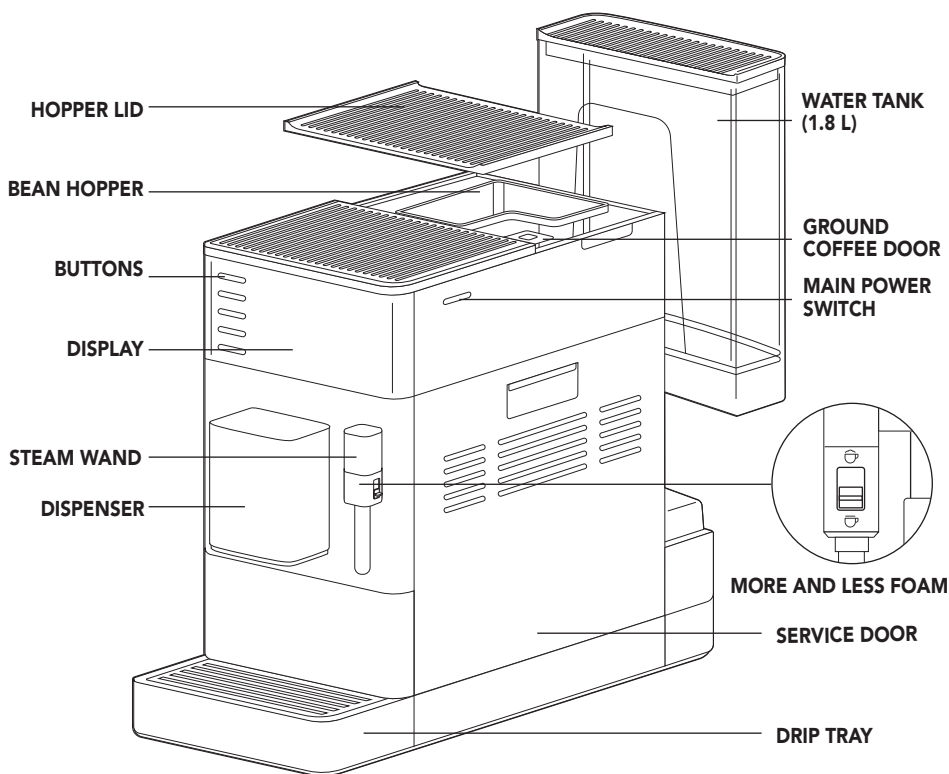

CLEANING TABLETS



WATER FILTER



HARDNESS STRIP



GROUND COFFEE SCOOP

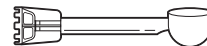

Scan for Quick Start

Scan here for set-up & how-to videos, recipes, care & maintenance, FAQ, warranty



QUICK START GUIDE

CONTROL PANEL DISPLAY

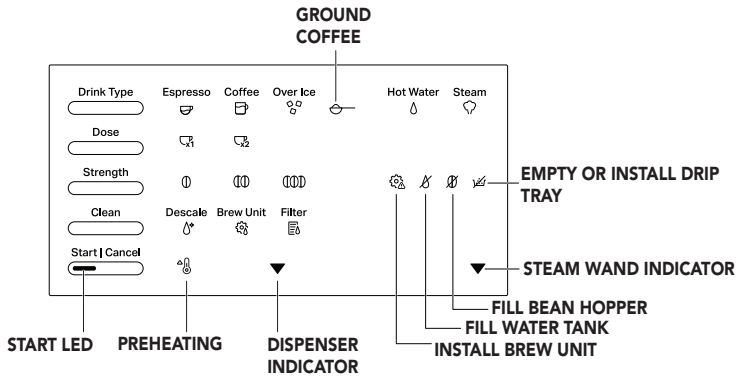

GETTING STARTED

1.

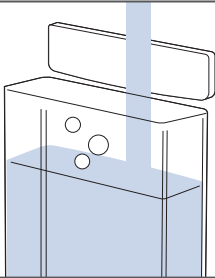

Clean Water Tank.

2.

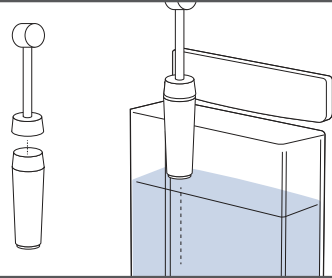

Insert Water Filter using end of Ground Coffee Scoop. Fill Water Tank to Max fill line.

3.

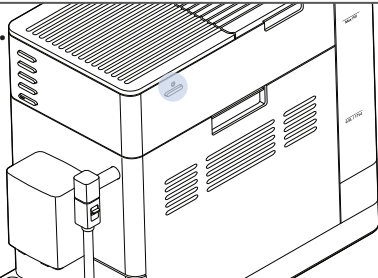

Power on machine. (Place container under Steam Wand and Dispenser.)

4.



When water filter icon () is illuminated, press the flashing Start button to rinse water filter through the Steam Wand and the dispenser.

QUICK START GUIDE

GETTING STARTED

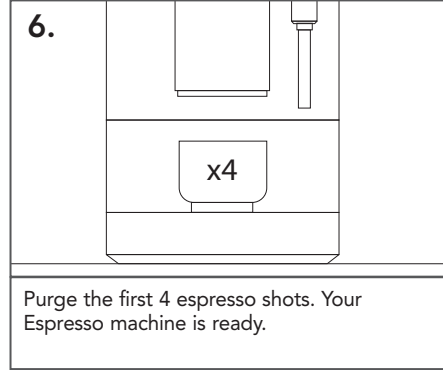
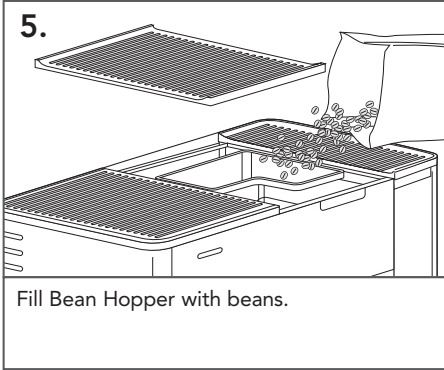

BREWING A COFFEE DRINK

NOTE: The machine will rinse at each Power On and Power Off. Power On rinsing pre-heats the system for the ideal brewing temperature. Power Off rinsing flushes away residue, and helps keep your machine clean for lasting performance.

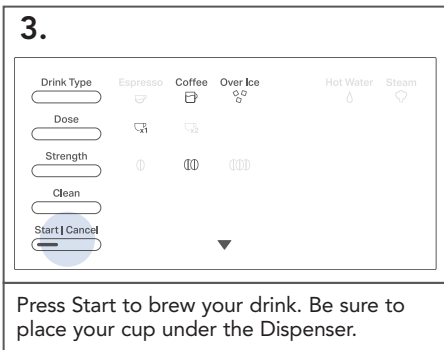
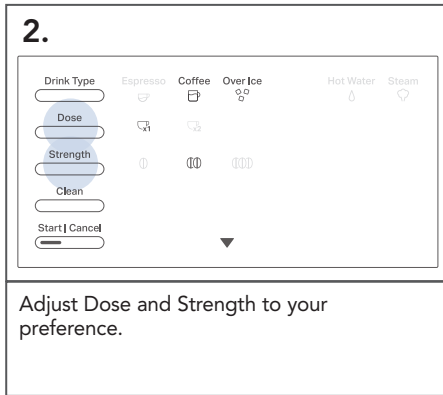
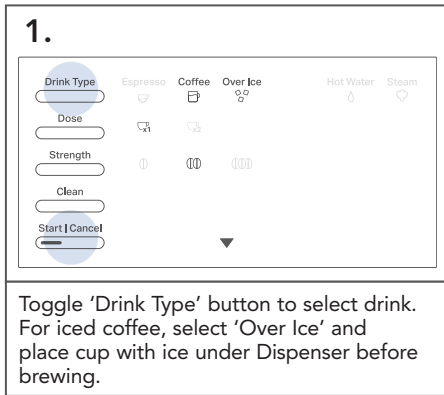

QUICK START GUIDE

STEAMING MILK

1.

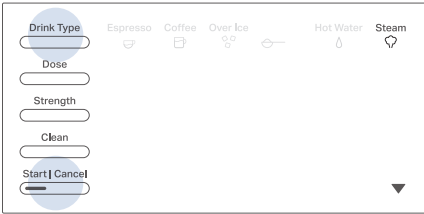

Toggle 'Drink Type' button to select Steam, press Start button to initiate preheat cycle.

2.

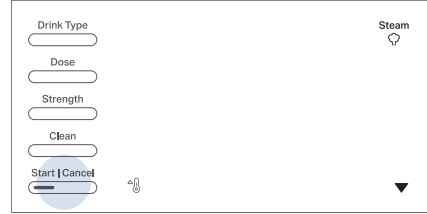

Once preheated, point the Steam Wand toward Drip Tray. Purge Steam Wand for 3 seconds by pressing Start/Cancel. Press Start/Cancel again to stop steam.

3.

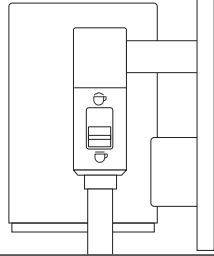

Select more foam/less foam on Steam Wand.

4.

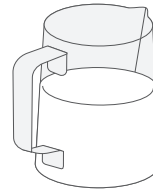

Fill milk pitcher (not included) with milk. Leave room for milk to expand during frothing.

5.

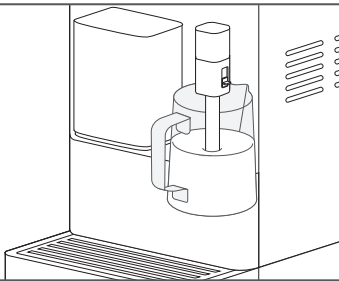

Submerge tip of the Steam Wand below the surface of the milk. Steam milk to desired temperature.

6.

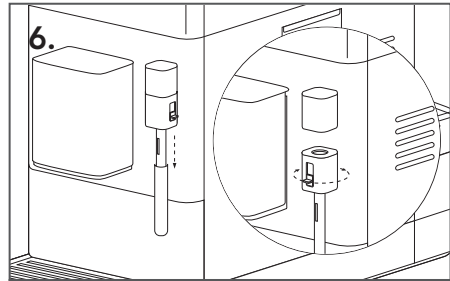

Purge and Clean Steam Wand after every use. Remove and clean metal tube and wipe down plastic portion of Steam Wand. Periodically clean entire Steam Wand by twisting clockwise to remove entire assembly.

QUICK START GUIDE

AMERICANO-HOT WATER

1.

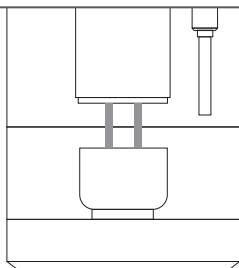

Brew an Espresso to your preference.

2.

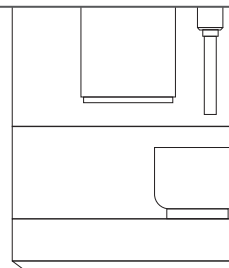

Move cup under Steam Wand.

3.





Toggle 'Drink Type' to Hot Water. Adjust the dose (single or double). Press Start to preheat and dispense.

Hot Water Volume:
Single: 120 ml (4 oz.)
Double: 240 ml (8 oz.)

NOTE: Water will dispense immediately after preheat temperature is reached. See the "Owner's Manual" for detailed information.

CARE AND MAINTENANCE

ICON	DESCRIPTION	FREQUENCY	DURATION
Descale 	Removes mineral build up	Every 6 months*	~15 minutes
Brew Unit 	Cleans oils deposited from beans	6-8 weeks*	~15 minutes
Filter 	Filter needs to be replaced	Every 2 months*	~2 minutes

*Depending on usage.

GUIDE DE DÉMARRAGE RAPIDE

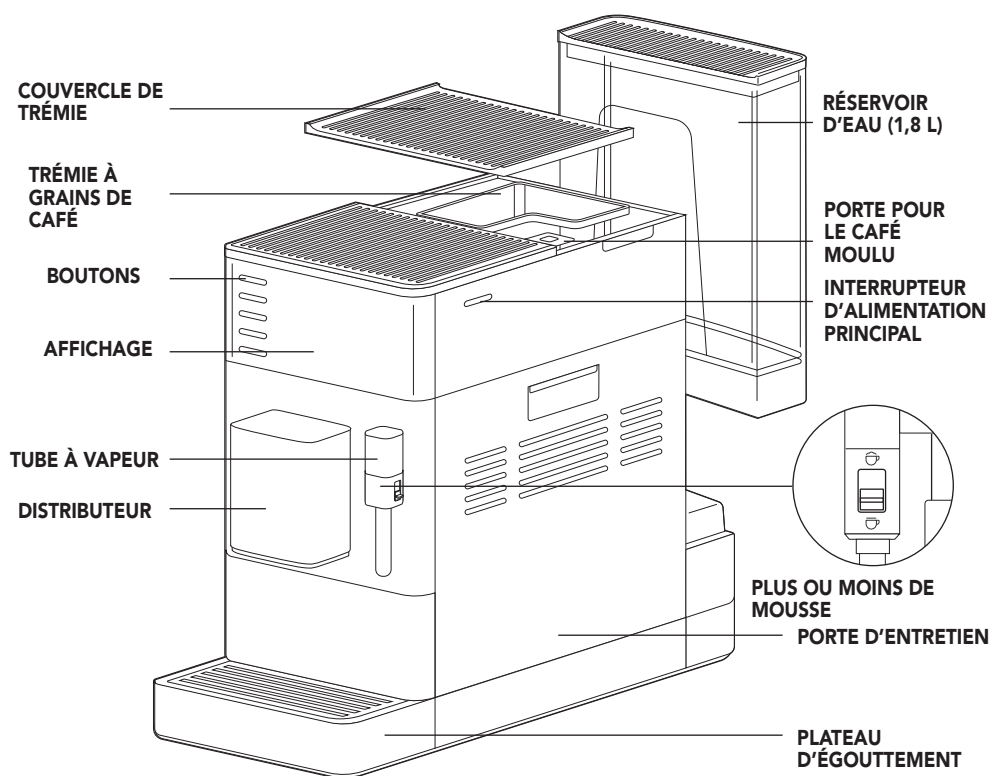

TABLETTES DE NETTOYAGE



FILTRE À EAU



BANDE DE DURETÉ



CUILLÈRE À CAFÉ MOULU

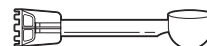

Numériser pour le démarrage rapide

Numériser ici pour accéder aux vidéos d'installation et d'utilisation, aux recettes, au nettoyage et à l'entretien, à la garantie et à la FAQ



GUIDE DE DÉMARRAGE RAPIDE

AFFICHAGE DU TABLEAU DE COMMANDE

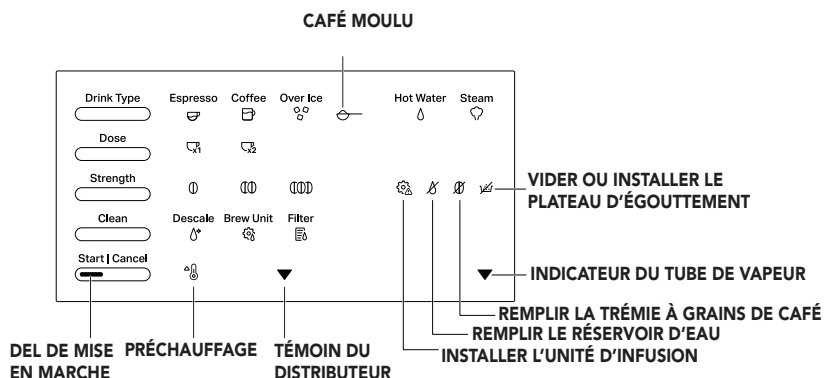

MISE EN PLACE

1.

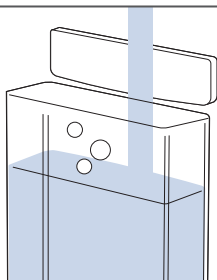

Nettoyer le réservoir d'eau.

2.

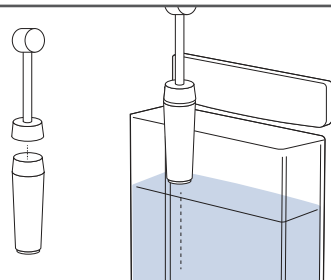

Insérer le filtre à eau en utilisant l'extrémité de la cuillère à café moulu. Remplir le réservoir d'eau jusqu'à la ligne de remplissage maximale.

3.

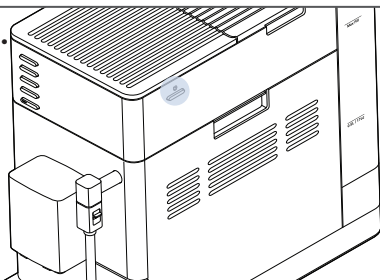

Mettre la machine sous tension. (Placer le récipient sous le tube à vapeur et le distributeur.)

4.

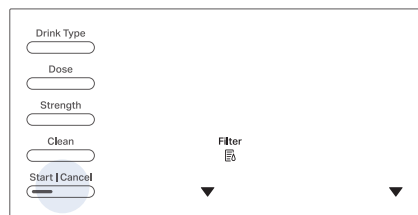

Lorsque l'icône du filtre à eau (☑️) s'allume, appuyer sur le bouton Mise en marche (Start) clignotant pour rincer le filtre à eau par le tube à vapeur et le distributeur.

GUIDE DE DÉMARRAGE RAPIDE

MISE EN PLACE

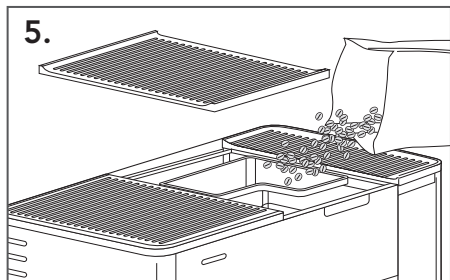

Remplir la trémie à grains de grains de café.

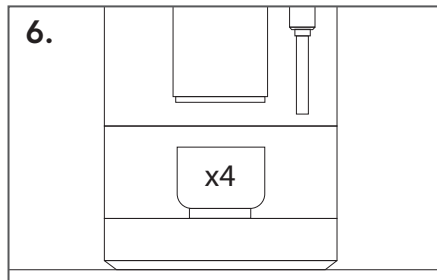

Purger les 4 premières doses d'espresso. La machine à espresso est prête.

PRÉPARER UN CAFÉ

REMARQUE : La machine se rince à chaque mise sous et hors tension. Le rinçage à la mise sous chauffe le système pour obtenir la température d'infusion idéale. Le rinçage à la mise hors tension élimine les résidus et aide à garder votre machine propre pour des performances durables.

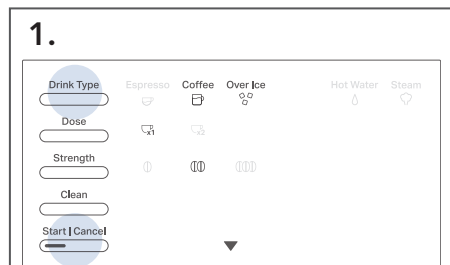

Appuyer sur le bouton « Type de boisson » (Drink Type) pour sélectionner la boisson. Pour le café glacé, sélectionner « Sur glace » (Over Ice) et placer la tasse contenant des glaçons sous le distributeur avant l'infusion.

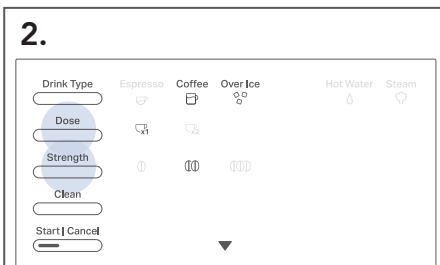

Régler la dose et l'intensité selon vos préférences.

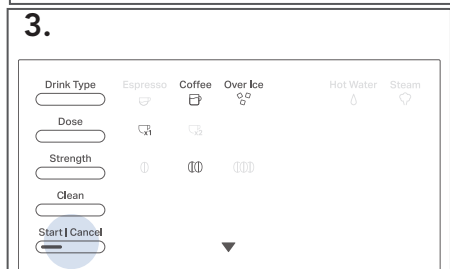

Appuyer sur Mise en marche (Start) pour infuser votre boisson. Placer la tasse sous le distributeur.

GUIDE DE DÉMARRAGE RAPIDE

CHAUFFER DU LAIT À LA VAPEUR

1.



Déplacer le bouton « Type de boisson » (Drink Type) sur Vapeur (Steam), appuyer sur le bouton Mise en marche (Start) pour lancer le cycle de préchauffage.

2.

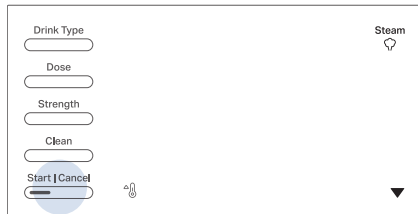

Après le préchauffage, pointer le tube à vapeur vers le plateau d'égouttement. Purger le tube de vapeur pendant 3 secondes en appuyant sur Mise en marche/arrêt (Start/Cancel). Appuyer à nouveau sur Mise en marche/arrêt (Start/Cancel) pour arrêter la vapeur.

3.

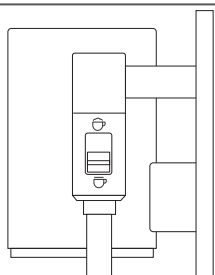

Sélectionner plus de mousse/moins de mousse (more foam/less foam) sur le tube à vapeur.

4.

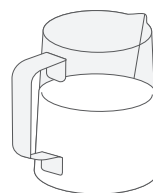

Remplir le pichet de lait (non fourni) de lait. Laisser de la place pour la dilatation du lait pendant le moussage.

5.

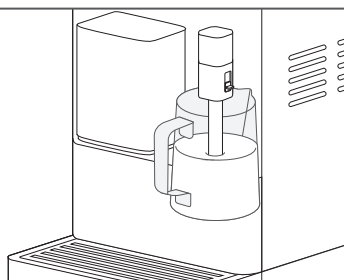

Immerger l'extrémité du tube à vapeur sous la surface du lait. Faire chauffer le lait à la vapeur jusqu'à la température désirée.

6.

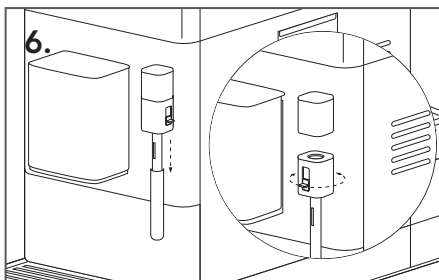

Purger et nettoyer le tube à vapeur après chaque utilisation. Retirer et nettoyer le tube métallique et essuyer la partie en plastique du tube à vapeur. Nettoyer périodiquement tout le tube à vapeur en la tournant dans le sens des aiguilles d'une montre pour retirer tout l'ensemble.

GUIDE DE DÉMARRAGE RAPIDE

EAU CHAUDE POUR AMERICANO

1.

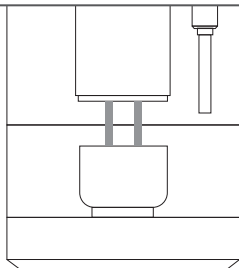

Préparer un espresso selon vos préférences.

2.

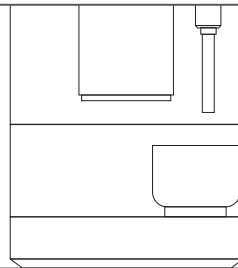

Déplacer la tasse sous le tube à vapeur.

3.

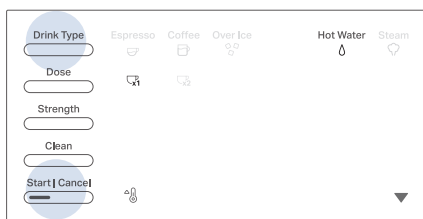

Basculer « Type de boisson » (Drink Type) sur eau chaude. Régler la dose (simple ou double). Appuyer sur Mise en marche (Start) pour préchauffer et distribuer.



Volume d'eau chaude :

Simple : 120 ml (4 oz)

Double : 240 ml (8 oz)

REMARQUE : L'eau sera distribuée dès que la température de préchauffage sera atteinte. Consulter le « Guide d'utilisation » pour obtenir des informations détaillées.

NETTOYAGE ET ENTRETIEN

ICÔNE	DESCRIPTION	FRÉQUENCE	DURÉE
Détartrage (Descale) 	Supprime les accumulations de minéraux	Tous les 6 mois*	~15 minutes
Unité d'infusion (Brew Unit) 	Nettoie les huiles déposées par les grains	6 à 8 semaines*	~15 minutes
Filtre (Filter) 	Le filtre doit être remplacé	Tous les 2 mois*	~2 minutes

*En fonction de l'utilisation.

GUÍA DE INICIO RÁPIDO

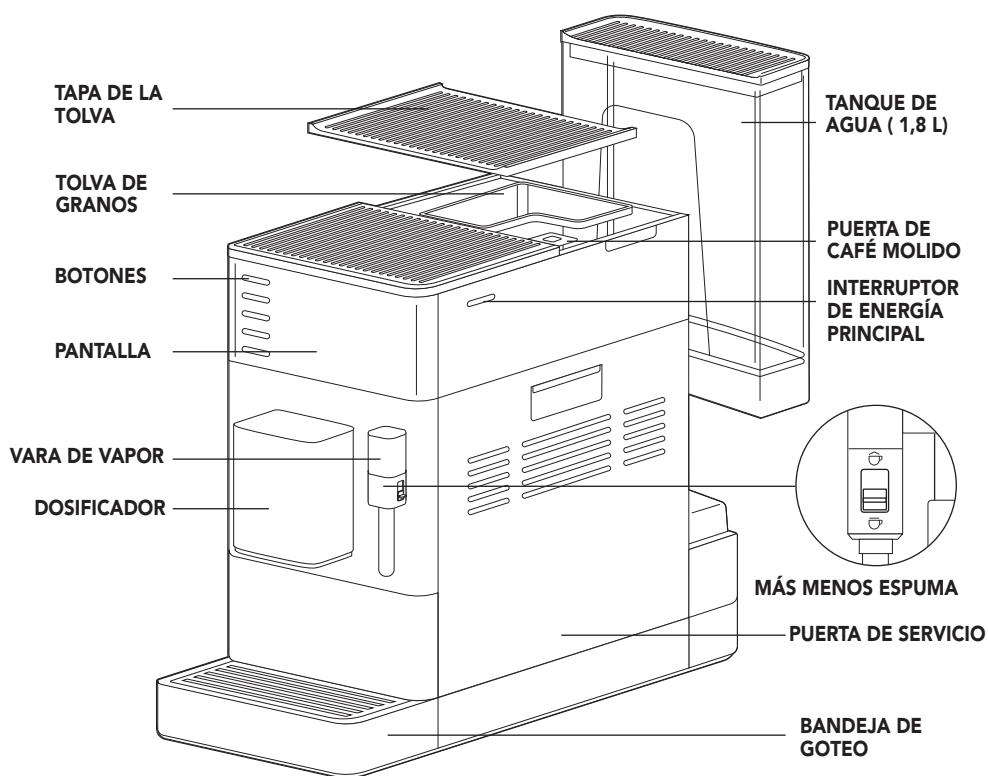

TABLETAS DE LIMPIEZA



FILTRO DE AGUA



BANDA DE DUREZA



CUCHARA PARA CAFÉ MOLIDO

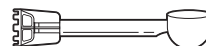

Escanear para inicio rápido

Escanee aquí para ver la configuración, videos instructivos, recetas, el cuidado y mantenimiento, las Preguntas frecuentes y la garantía



GUÍA DE INICIO RÁPIDO

PANTALLA DEL PANEL DE CONTROL

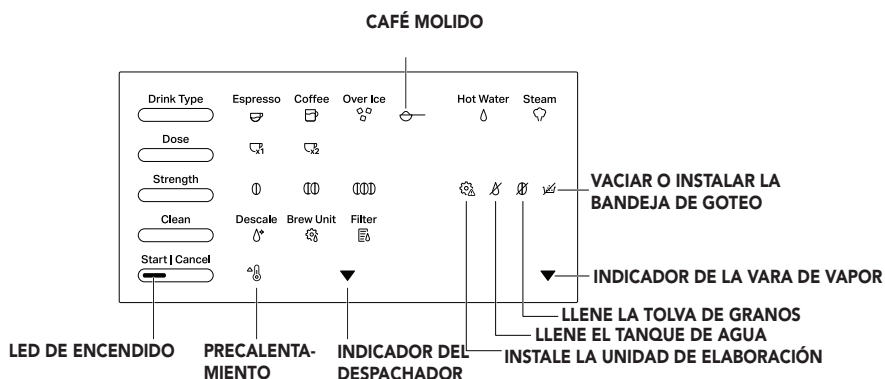

CÓMO COMENZAR

1.

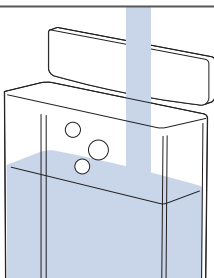

Limpie el tanque de agua.

2.

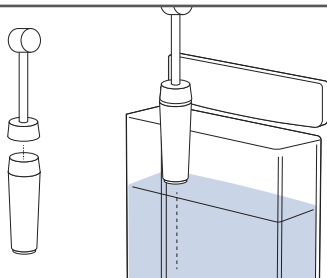

Inserte el filtro de agua con el extremo de la cuchara de café molido. Llene el tanque de agua hasta la línea de llenado Max.

3.

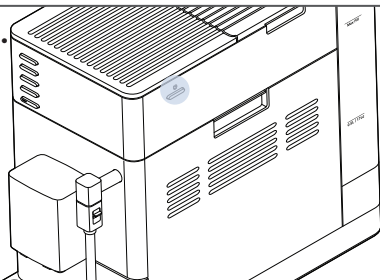

Encienda la máquina. (Coloque el recipiente debajo de la vara de vapor y el despachador.)

4.

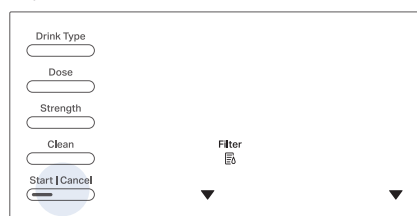

Cuando el icono del filtro de agua (☒) esté iluminado, presione el botón Inicio (Start) que parpadea para enjuagar el filtro de agua a través de la vara de vapor y el despachador.

GUÍA DE INICIO RÁPIDO

CÓMO COMENZAR

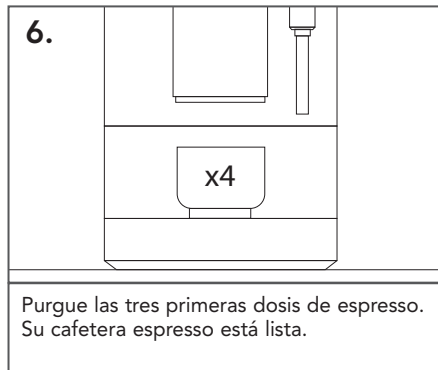
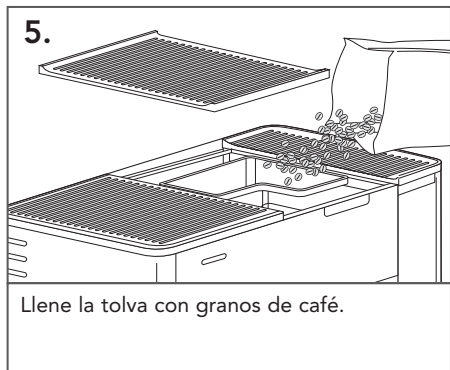

PARA ELABORAR UNA BEBIDA DE CAFÉ

NOTA: La máquina se enjuagará en cada encendido y apagado. El enjuague con encendido precalienta el sistema para obtener la temperatura de infusión ideal. El enjuague sin encendido elimina los residuos y ayuda a mantener su máquina limpia para un rendimiento duradero.

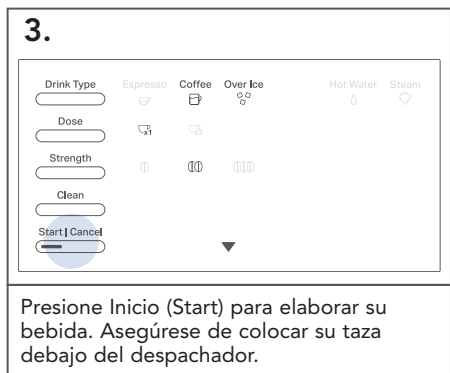
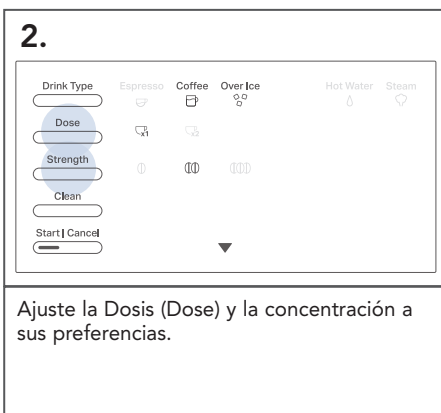
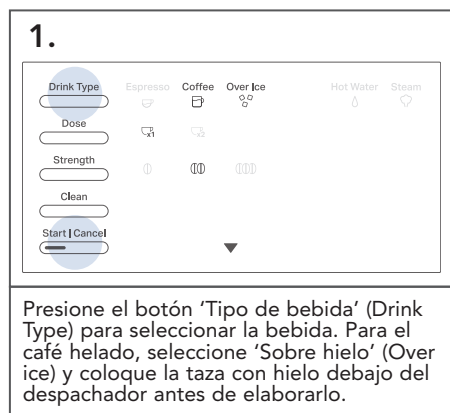

GUÍA DE INICIO RÁPIDO

LECHE AL VAPOR

1.



Presione el botón 'Tipo de bebida' (Drink Type) para seleccionar el vapor, presione el botón Inicio (Start) para iniciar el ciclo de precalentamiento.

2.

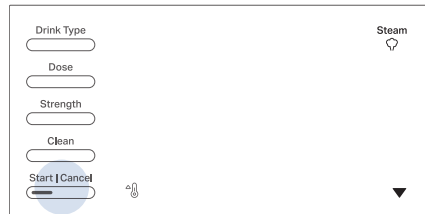

Una vez precalentado, apunte la vara de vapor hacia la bandeja de goteo. Purgue la vara de vapor durante 3 segundos presionando Inicio/Cancelar (Start/Cancel). Presione Inicio/Cancelar (Start/Cancel) de nuevo para detener el vapor.

3.

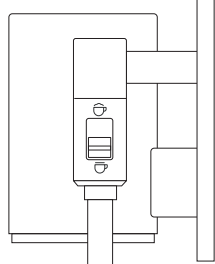

Seleccione más/menos espuma en la vara de vapor.

4.

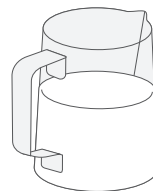

Llene la jarra para leche (no incluida) con leche. Deje espacio para que la leche se expanda durante la formación de la espuma.

5.

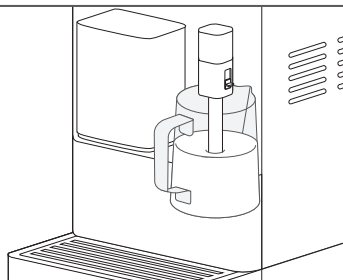

Sumerja la punta de la vara de vapor por debajo de la superficie de la leche. Hierva la leche a la temperatura deseada.

6.

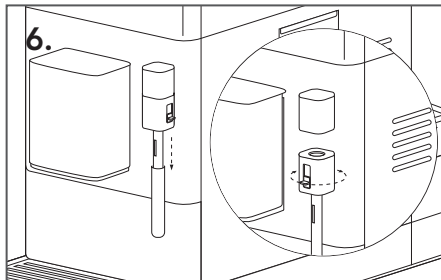

Purgue y limpie la vara de vapor después de cada uso. Retire y limpie el tubo de metal y limpie la porción de plástico de la vara de vapor. Limpie periódicamente toda la vara de vapor girándola en sentido horario para retirar todo el conjunto.

GUÍA DE INICIO RÁPIDO

AMERICANO-AGUA CALIENTE

1.

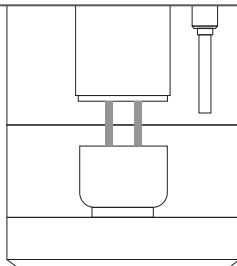

Elabore un café espresso según sus preferencias.

2.

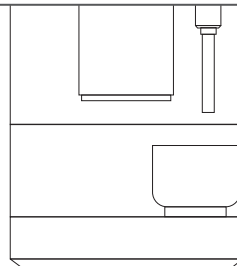

Ponga la taza debajo de la vara de vapor.

3.

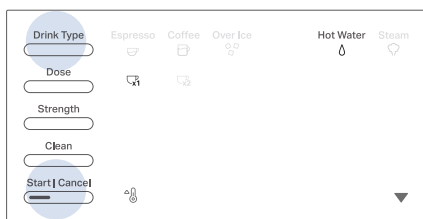

Cambie 'Tipo de bebida' (Drink Type) a Agua caliente (Hot Water). Ajuste la dosis (simple o doble). Presione Inicio (Start) para precalentar y dispensar.



Volumen de agua caliente:

Simple: 120 ml (4 oz)

Doble: 240 ml (8 oz)

NOTA: Se dispensará agua inmediatamente después de alcanzar la temperatura de precalentamiento. Consulte el "Manual del propietario" para obtener información detallada.

CUIDADO Y MANTENIMIENTO

ICONO	DESCRIPCIÓN	FRECUENCIA	DURACIÓN
Descalcificar (Descale) 	Retira minerales acumulados	Cada 6 meses*	~15 minutos
Unidad de elaboración (Brew Unit) 	Limpia los aceites depositados de los granos	6-8 semanas*	~15 minutos
Filtro (Filter) 	El filtro debe ser reemplazado	Cada 2 meses*	~2 minutos

*Dependiendo del uso.



NOTES





NOTES





NOTES





KitchenAid[®]

®/™ ©2025 KitchenAid. All rights reserved. Used under license in Canada.
Tous droits réservés. Utilisé sous licence au Canada.
Todos los derechos reservados. Usado bajo licencia en Canadá.

