

MF275R

User Guide

ZTE CORPORATION
NO. 55, Hi-tech Road South, ShenZhen, P.R.China
Postcode: 518057
Tel: +86-755-26779999
URL: www.ztedevice.com
E-mail: mobile@zte.com.cn

LEGAL INFORMATION

Copyright © 2016 ZTE CORPORATION.

All rights reserved.

No part of this publication may be excerpted, reproduced, translated or utilized in any form or by any means, electronic or mechanical, including photocopying and microfilm, without the prior written permission of ZTE Corporation.

The manual is published by ZTE Corporation. We reserve the right to make modifications on print errors or update specifications without prior notice.

Version No. : R1.0

Edition Time: August 24, 2016

Contents

Getting Started	1
Appearance.....	1
Indicators.....	2
Installation Guide.....	3
Installing the micro-SIM Card and battery.....	3
Connecting Your Device	4
Switching on Your Device	4
About micro-SIM Card	5
Internet Access.....	5
Wireless Connection	5
Accessing the Internet	6
Calling	7
Making a Call.....	7
Three-Way Calling.....	7
Call Waiting	7
Call Forwarding	8
Voicemail.....	9
Setup.....	9
Message Waiting	9
Retrieving Messages	9
WebUI Configuration	9
Accessing the Configuration Page	9
Login	10
Settings	10
Network Settings.....	10
Wi-Fi Settings	13
Device Settings.....	17
Firewall	20
Router Settings.....	25
Information	26
Device Information	26
Statistics	27
Data Limit Settings	27
SMS	28
Operating Messages in Native.....	28
Operating Messages in micro-SIM Card.....	29
Configuring Messages.....	29
Warning and Notice	30
Safety Precautions	30
Cleaning and Maintaining.....	30
Limited Warranty	30
Limitation of Liability	31
FCC Compliance	31
RF Exposure.....	32
IC.....	32
Troubleshooting.....	33

Getting Started





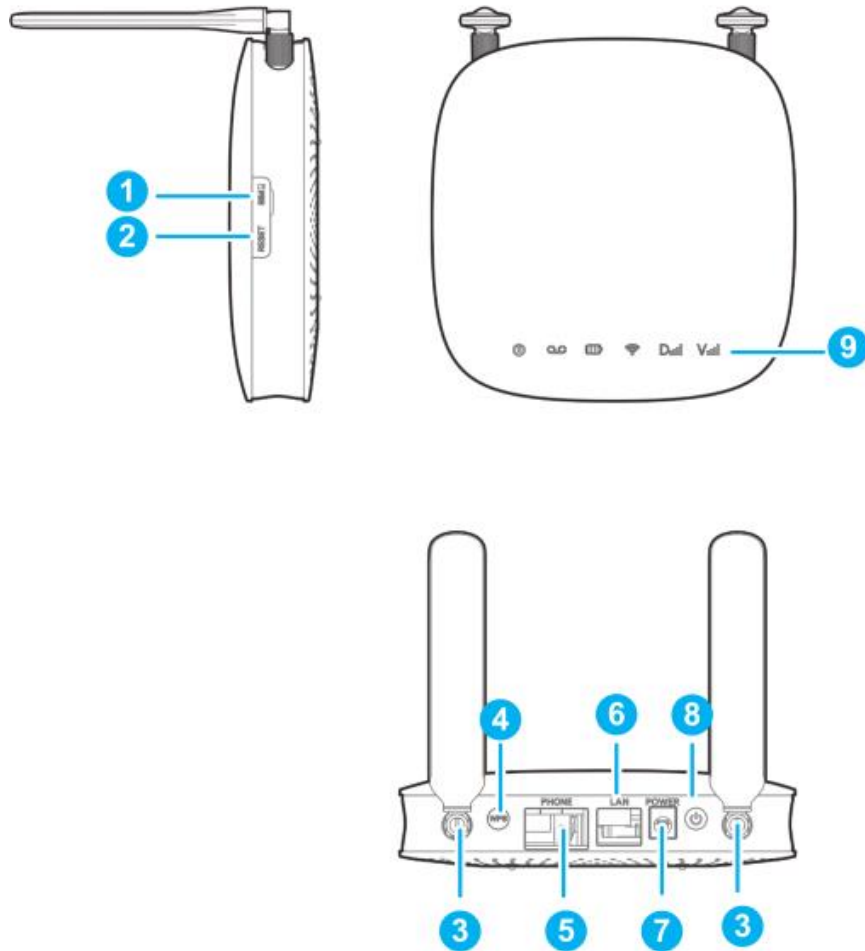

The device operates on 4G/LTE networks and supports voice and data services.

Appearance



1. SIM Card slot	Insert your micro-SIM Card.
2. Reset button	Reset your device.
3. External antenna	To strengthen signal.
4. WPS button	To activate the WPS function.
5. Phone	RJ11 connector for connection to telephone.
6. LAN	RJ45 Ethernet connector for connection to computer.
7. Power Socket	Connector for the external power supply.
8. Power Switch	Turn your device on or off.
9. Indicators	Indicates the status of your device.

Indicators

Indicator	State	Description
Power 	Green steady	AC power present
	Off	No AC power
Voicemail 	Green blinking	New voicemail waiting
	Off	No new voicemail
Battery 	Green steady	More than 50% discharging (charger not present)
	Green blinking	More than 50% charging (charger present)
	Yellow steady	20%-50% discharging (charger not present)
	Yellow blinking	20%-50% charging (charger present)
	Red steady	Less than 20% discharging(charger not present)
	Red blinking	Less than 20% charging (charger present)
	Off	Battery not present
Wi-Fi 	Green steady	Wi-Fi on
	Blinking	Active data connection or FOTA
	Off	Wi-Fi off
Network 	Green steady	Connected to the LTE network
	Green blinking	Roaming (LTE network)
	Yellow steady	Connected to the 4G network
	Yellow blinking	Roaming (4G network)
	Red steady	No service, limited service, searching for network, no SIM Card or other abnormal status
Signal Strength 	Green steady	Strong signal
	Yellow steady	Weak signal
	Red steady	No service, limited service, or searching for signal

Installation Guide

Installing the micro-SIM Card and battery

1. Install the micro-SIM card.



 **WARNING!**

- Switch off your device before installing or replacing the micro-SIM card.
 - Your device only supports a micro-SIM card.
 - To avoid damaging the device, please only use the card that is provided by your service provider and ensure that the micro-SIM card contacts are facing up when inserting it into the micro-SIM slot.
2. Slide the back cover and remove it

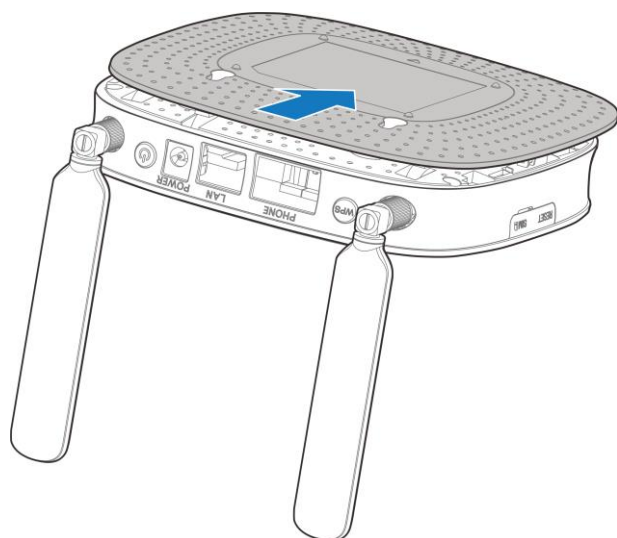

3. Insert the battery.

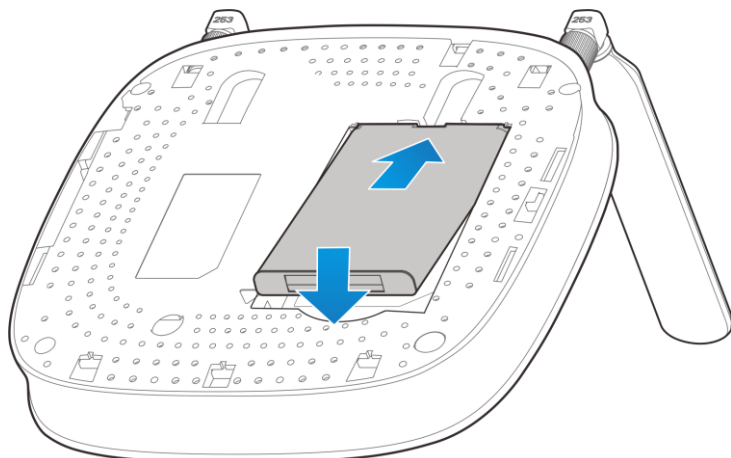

Connecting Your Device

Please refer to the below picture before connecting to your device. If you want to use the mobile network to connect to the Internet or use your land line phone, you will need to insert your micro-SIM card first.

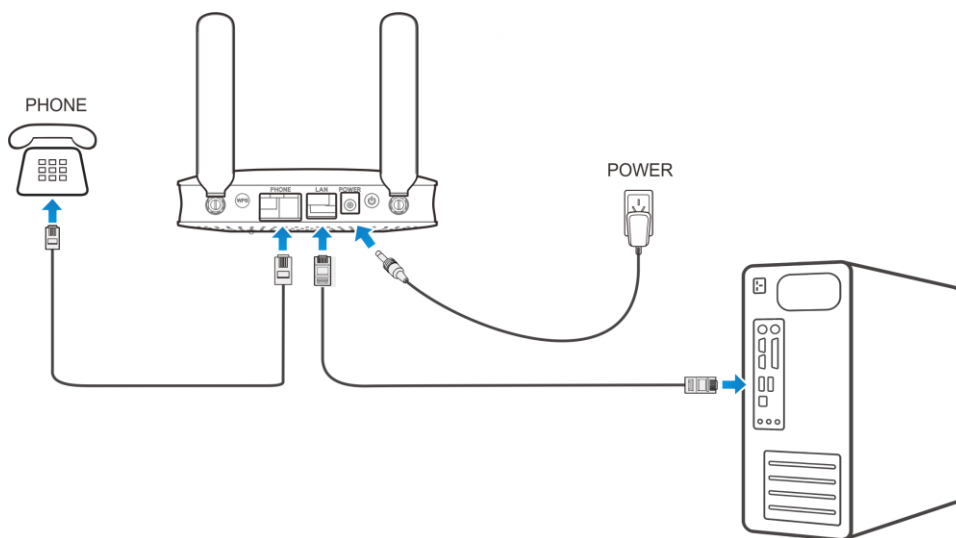

Switching on Your Device

Press and hold the Power Switch to get started. Make sure that the phone is on the hook before you power on.

 **NOTE:**

Do not put anything on the top of the device. Do not stack multiple devices on top of each other during usage.

About micro-SIM Card

Avoid handling the micro-SIM card unnecessarily. Hold the card by the edges to prevent static damage. Keep the micro-SIM card away from electrical and magnetic appliances.

If you cannot get service, make sure that:

- You are in an area which has network coverage
- The antennae are firmly attached to the device
- You are using the correct micro-SIM card

Internet Access

Wireless Connection

If you want to use Wi-Fi to connect to your MF275R, please refer to the following steps.

1. Make sure that Wi-Fi is enabled. Please check the Wi-Fi Setting on the WebUI Configuration page or check the Wi-Fi indicator .

2.4GHz SSID

2.4GHz SSID Switch Enable Disable

Apply

Cancel

2. Use your normal Wi-Fi application on the client to search for available wireless networks.



NOTE:

Please set the client to use DHCP to obtain an IP address automatically, and the client will get an IP address like “192.168.0.100”.

3. Select the SSID (wireless networks name) of your device, and then click **Connect**.



4. Input the password, and then click **OK**.

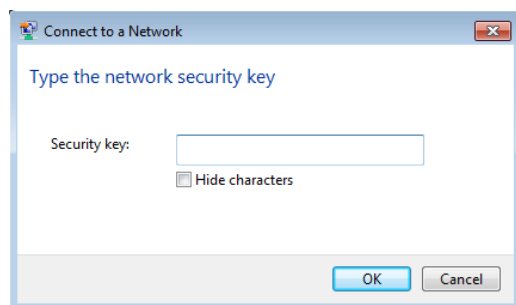

 **NOTE:**

You may need to input a password for the Wi-Fi connection. Please check the label on your MF275R to get the default password.

5. After a few moments, the client will connect to your MF275R.

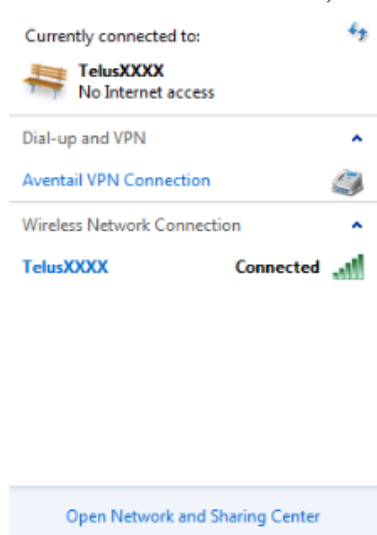

If you want to use **WPS** function to enable a Wi-Fi connection, please:

1. Power on your device, and enable the Wi-Fi function on your device.
2. Please check that the **WPS** Setting on the WebUI Configuration page is enabled.
3. Press the **WPS** button on your device to start the Wi-Fi Protected Setup authentication process.
4. Enable the **WPS** function on your client device.
5. Follow the system prompts on your client to finish the connection process.

Accessing the Internet

After the client is connected to your device successfully, you can access the Internet in the **Automatic** or **Manual** mode. The default mode is **Automatic**.

Mode	Operations
Automatic	Your device will connect to the Internet automatically.
Manual	1. Log in the WebUI configuration page.

	<ol style="list-style-type: none">2. Select Settings > Network Settings > Connection Mode > WAN Connection Mode > Manual, and then click Apply.3. Select Home, and then click Connect or Disconnect.
--	--

**NOTE:**

If you want to modify the detailed parameters of your device, please log into the WebUI configuration page by visiting <http://192.168.0.1> or <http://telus.ztesmarthub>. The default password is **admin**.

Calling

Making a Call

Using a phone connected to your device allows you to place and receive calls as you normally would. The device supports both cordless and corded phone dialing methods.

Note: Make sure to dial the 10-digit phone number, including area code.

Three-Way Calling

While on an existing call, press the Flash (or Talk) key on your phone to put the first party on hold. When you hear a dial tone, dial the second party's number (wait up to four seconds).

When the second party answers, press the Flash (or Talk) key again to complete the three-way connection. If the second party does not answer, press the Flash (or Talk) key to end the connection and return to the first party.

Note: If your phone does not have a Flash (or Talk) key, use the off-hook mechanism supported by your phone instead.

Call Waiting

Press *43# or #43# to enable or disable Call Waiting features.

You will hear two tones if someone calls while you are already on a call.

To hold the current call and accept the waiting call, press the Flash (or Talk) key. You can press the Flash (or Talk) key anytime to switch back and forth between calls.

To end the current call and accept the waiting call, enter "1" and press the Flash (or Talk) key.

To reject (User Busy) the waiting call, enter "0" and press the Flash (or Talk) key.

Notes:

- Your device comes with standard three-way calling and call waiting. Operation of these

features will vary depending on your home phone equipment.

- If your phone does not have a Flash (or Talk) key, then use the off-hook mechanism supported by your phone.

Call Forwarding

With Call Forwarding you can forward calls to another phone number.

Always forward

1. Press *21* on your connected phone.
2. Dial the 10-digit number to which you wish to forward your calls.
3. Press the “#” key.

(Example: *21*1234567890# forwards your calls to the phone number 123-456-7890)

4. Wait for 3 seconds until you hear a confirmation tone for the forwarding process to complete before hanging up.

Note:

To un-forward calls, press #21#, wait for 3 seconds until you hear a confirmation tone for the un-forwarding process to complete before hanging up.

Forward when busy

1. Press *67* on your connected phone.
2. Dial the 10-digit number to which you wish to forward your calls.
3. Press the “#” key.
4. Wait for 3 seconds until you hear a confirmation tone for the forwarding process to complete before hanging up.

Note: Press #67# to un-forward calls.

Forward when unanswered

1. Press *61* on your connected phone.
2. Dial the 10-digit number to which you wish to forward your calls.
3. Press “#” key.

(Example: *61*1234567890**10# forwards your calls to the phone number 123-456-7890, if you don't answer the calls for 10 seconds.)

4. Wait for 3 seconds until you hear a confirmation tone for the forwarding process to complete before hanging up.

Note: Press #61# to un-forward calls.

Forward when unreachable

1. Press *62* on your connected phone.
2. Dial the 10-digit number to which you wish to forward your calls.
3. Press “#” key.
4. Wait for 3 seconds until you hear a confirmation tone for the forwarding process to complete before hanging up.

Note: Press #62# to un-forward calls.

Voicemail

Your MF275R supports wireless voicemail. Follow the steps below to set up and use your voicemail.

Setup

Dial 1 on any home phone connected to your device and wait for four seconds to connect to your wireless voicemail. Simply follow the voice prompts to complete setup.

Message Waiting

There are two indicators for a new message waiting: 1) the voicemail indicator ; and 2) an intermittent dial tone

The voicemail indicator on your device flashes when a voicemail message is waiting. You will also hear an intermittent dial tone on any connected phone handset before placing a call.

Retrieving Messages

To retrieve voice messages, dial 1 on any home phone connected to your device and wait for four seconds to connect to your wireless voicemail box. Simply follow the voice prompts to listen to and manage your messages. (Alternately, you may dial your 10-digit home phone number to access your voicemail box.)

WebUI Configuration

Accessing the Configuration Page

1. Make sure the connection between your devices is active (either by cable or WiFi).
2. Launch the Internet browser, and then enter http://192.168.0.1 (or other IP if you have changed it from the default) or http://telus.ztesmarthub in the address bar.

 **NOTE:**

It is recommended that you use IE (8.0 or later), Firefox (31.0 or later), Opera (23.0 or later), Safari (6.2 or later) or Google Chrome (36.0 or later).

3. The login page will appear as follows.

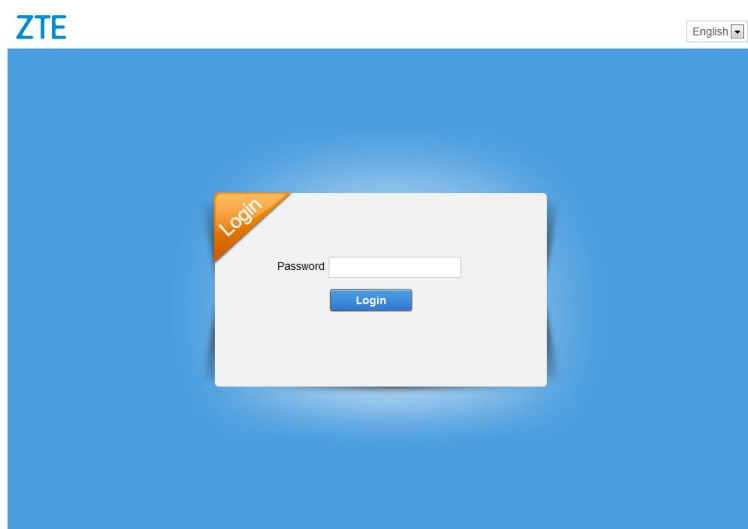

Login

In the WebUI Configuration page, select the desired language and input the password (the default Password is **admin**).

Click **Login** to proceed.

Settings

Do not modify any settings unless instructed by your service provider.

Please disconnect the device from the cellular network before making changes to settings.

Network Settings

Connection Mode

Select **Settings > Network Settings > Connection Mode**.

You can set the WAN connection mode here. The default mode is Automatic.

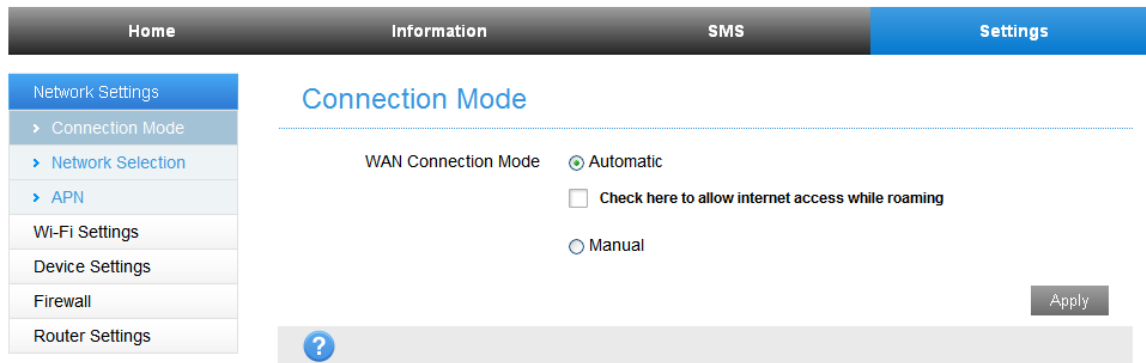

 **NOTES:**

- To change the current settings, please disconnect from the cellular network first.
- After changing the connection mode to **Manual**, you need to go to the **Home** page and click **Connect** to connect to the Internet.

Network Selection

Select **Settings** > **Network Settings** > **Network Selection**.

You can set the device to search for the network automatically.

Network Selection

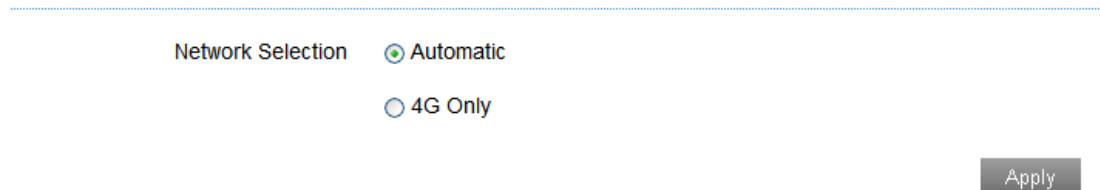

- **Automatic:** The device will search for the available network automatically.
- **4G Only:** The device searches for 4G network only.

Click **Apply** to confirm your configuration.

 **NOTE:**

To change the current settings, please disconnect from the cellular network first.

APN Setting

Select **Settings** > **Network Settings** > **APN**.

The APN parameters are shown in the following figure.

APN

Current APN TELUS ISP (Default)

Mode Auto Manual

Profile

Profile Name *

APN *

Authentication

User Name

Password

Set as default: Click to set current profile as the default profile.

To add a new APN profile, follow the steps below:

1. Select **Manual** mode in the figure above.

APN

Current APN TELUS ISP

Mode Auto Manual

Profile

Profile Name *

APN *

Authentication

User Name

Password

2. Click **Add New** to access the following figure.

APN

Current APN TELUS ISP

Mode Auto Manual

Profile

Profile Name *

APN *

Authentication

User Name

Password

3. Enter the related parameters (please see following table), and then click **Apply** to add a new profile.

Parameter	Function
Mode	If a fixed APN is provided by your service provider, select Manual APN. Otherwise, please select Auto APN, and the device will automatically obtain parameters.
Profile	Shows the profile.
Profile Name	Type the profile name.
APN	Type the APN string.
Authentication	Password Authentication Protocol (PAP) provides a simple method without encryption for the peer to establish its identity using a 2-way handshake. Challenge-Handshake Authentication Protocol (CHAP) is used to periodically verify the identity of the peer using a 3-way handshake.
User Name	User name is used to obtain authentication from the ISP when the connection is established.
Password	Password is used to obtain authentication from the ISP when the connection is established.

 **NOTES:**

- The **Profile Name** and **APN** are mandatory, others are optional.
- If the **Authentication** is set to **NONE**, you don't need to set the **User Name** and **Password**.

Wi-Fi Settings

Basic Settings

Select **Settings > Wi-Fi Settings > 2.4GHz / 5.0GHz**

The wireless network basic parameters are shown in the following figure.

Network Settings
Wi-Fi Settings
> 2.4 GHz
> 5.0 GHz
> Black List
> WPS
Device Settings
Firewall
Router Settings

2.4GHz SSID

2.4GHz SSID Switch Enable Disable

Apply

Cancel

Basic Settings

Network Name (SSID) *

Broadcast Network Name (SSID) Enable Disable

AP Isolation Enable Disable

Security Mode

Pass Phrase * Display Password

Max Station Number

Apply

Cancel

Advanced Settings

Network Mode

Channel Bandwidth

Country/Region Code

Frequency (Channel)

Apply

Cancel

- **2.4GHz SSID Switch:** Enable or disable 2.4GHz SSID function.
- **Network Name (SSID):** Service Set Identifier (SSID). Enter a string less than 32 characters as the name for your wireless local area network (WLAN).
- **Broadcast Network Name (SSID):** Disable or Enable (Default) this function. If **Enable** is selected, the device broadcasts the SSID, and other devices can search and connect to it. When you select **Disable**, other devices cannot search out the SSID. If you want someone to connect, you need to tell them the SSID, and let them setup the connection manually.
- **AP Isolation:** When **Enabled** is selected, your wireless clients will not be able to communicate with each other. When **Disable** is selected, your wireless clients will be able to communicate with each other.

- **Security Mode:** The security modes are described below:

Mode	Description
OPEN	Authentication and encryption won't be active. There are risks that private information can be intercepted or that the network will be used by unauthorized individuals.
WPA2(AES)-PSK	A more secure version of WPA with implementation of the 802.11i standard.
WPA-PSK/WPA2-PSK	Apply both the WPA-PSK and WPA2-PSK schemes.

- **Pass Phrase:** Set the password for your wireless local area network.
- **Frequency (Channel):** Choose the appropriate channel to optimize the performance and coverage of your wireless network.
- **Max Station Number:** Choose the maximum number of the devices that can connect to the Wi-Fi hotspot simultaneously.

Click **Apply** to confirm your configuration.



NOTE:

Your device has two Wi-Fi SSIDs, select **Settings > Wi-Fi Settings > 2.4GHz / 5.0GHz**, and you can set the band selection, network mode, channel bandwidth and other Wi-Fi advanced settings.

Black List

Select **Setting > Wi-Fi Settings > Black List**

The Black List page is shown in the following figure.

Black List

Black List Enable Disable

Apply

No.	Host Name	MAC Address
-----	-----------	-------------

Device Information

No.	Host Name	MAC Address	
1	host1	18:9E:FC:56:3E:BF	Block

All the clients connected to your device are shown in the **Device Information** area. Click **Block** behind the device you want to block and then it will be added to the black list. Devices on the black list will not be able to use the device to connect to the network.

Click **Delete** to delete the device from the black list and then the device will be able to access the network again.

WPS

Select **Settings > Wi-Fi Settings > WPS**

You can enable Wi-Fi Protected Setup (WPS) by PIN (PIN code) or PBC (push-button) mode; the two modes are described below:

WPS(2.4GHz SSID)

SSID Telus4B05

WPS * PIN
 PBC

Apply

WPS(5.0GHz SSID)

SSID Telus5G4B05

WPS * PIN
 PBC

Apply

- **PIN:** A device will need to provide the specified PIN to connect to the network when using WPS.
- **PBC:** Press the WPS button of the device or select PBC, and then click Apply. Press the WPS button on the client wireless adapter within two minutes, and the negotiation process will be established.

 **NOTE:**

Your device has two WPS selections to configure the two Wi-Fi SSIDs.

Device Settings

Account Management

Select **Settings > Device Settings > Account Management**.

The administrator settings information is shown in the following figure.

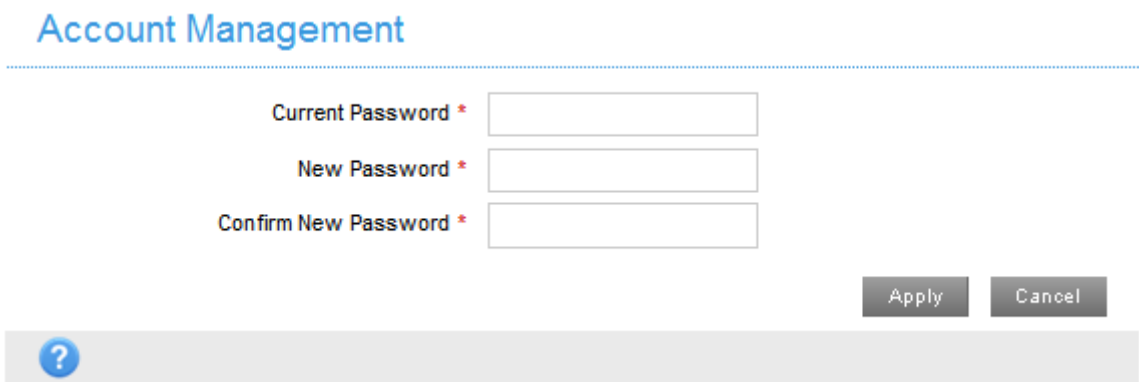

The screenshot shows the 'Account Management' settings page. It features three input fields: 'Current Password *', 'New Password *', and 'Confirm New Password *'. To the right of these fields are two buttons: 'Apply' and 'Cancel'. Below the input fields is a grey bar with a blue question mark icon.

You can change the administrator’s password. Click **Apply** to confirm your configuration.

SIM PIN Management

Select **Settings > Device Settings > SIM PIN Management**.

The PIN management is shown in the following figure.

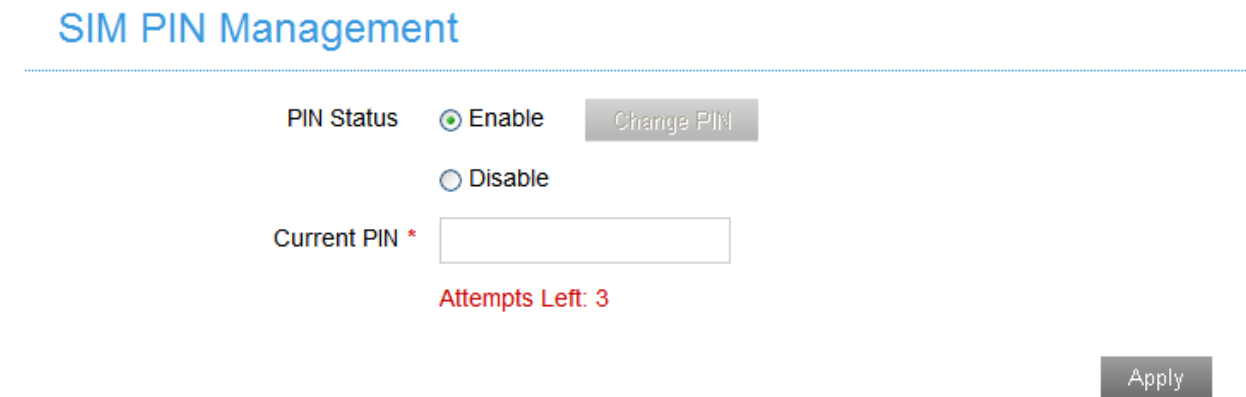

The screenshot shows the 'SIM PIN Management' settings page. It includes a 'PIN Status' section with radio buttons for 'Enable' (selected) and 'Disable'. A 'Change PIN' button is located to the right of the 'Enable' option. Below this is a 'Current PIN *' input field. Underneath the input field, the text 'Attempts Left: 3' is displayed in red. An 'Apply' button is positioned at the bottom right of the form.

• **PIN Status:** Shows the current PIN status and allows you to select PIN status.

• **Current PIN:** Type the PIN code.

If you select **Change PIN**, the modification parameters are shown in the following figure:

PIN Management

PIN Status Enable
 Disable

Current PIN *

New PIN *

Confirm New PIN *

Attempts Left: 3

Type the old PIN code, and then type the new PIN code twice. Click **Apply** to confirm your configuration.

NOTES:

- If you enter the incorrect PIN three times the micro-SIM card will be blocked.
- When you manage your PIN code, you need to disconnect from the network first.
- After changing the PIN code, you don't need to input the PIN code again. The PIN code is required every time the device is restarted.

Reset

Select **Settings > Device Settings > Reset**

Click **Reset** to set all the settings to their factory default values, and then the device will restart automatically.

Reset Factory Settings

Reset Factory Settings



Restart

Select **Settings > Device Settings > Restart**

Click **Restart** to restart your device manually.

Restart

Restart Device

Restart

SNTP

Select **Settings > Device Settings > SNTP**

You can set the device's time manually or set the device to obtain time from an SNTP server automatically. The default time set mode is **SNTP auto Synchronization**.

SNTP

Current Local Time	2000-01-01 00:03:32	Saturday
Time Set Mode	Sntp auto Synchroniza ▼	
SNTP Server1 *	time.windows.com ▼	
SNTP Server2 *	pool.ntp.org ▼	
SNTP Server3 *	europe.pool.ntp.org ▼	
Time Zone	GMT-06:00 ▼	
Daylight Saving Time	Enable ▼	

Apply

- **Current Local Time:** Shows current local time.
- **Time Set Mode:** Choose to set the time automatically or manually from the drop-down list.
- **SNTP server 1/2/3:** Choose SNTP server from the drop-down list.
- **Time Zone:** Choose your time zone from the drop-down list.
- **Daylight Saving Time:** Enable or disable the Daylight Saving Time.

Click **Apply** to confirm your configuration.

To set the device's time manually, follow the steps below.

1. Choose **Manual Set Time** from the **Time Set Mode** drop-down list.

Sntp

Current Local Time 2000-01-01 00:04:27 Saturday

Time Set Mode

Manual Set Time Year Month Date Hour Minute

- Set the time and then click **Apply** to confirm your configuration.

Update Management

Select **Settings > Device Settings > Update Management**

The update management is shown in the following figure.

Enable will set the device to automatically check for updates. You can change the **Auto-check Cycle** to the desired update schedule. **Disable** will set the device to not check for device updates automatically.

You can click the **Check** button to manually check for new software at any time.

Cycle Settings

Auto-check New Version Enable Disable

Auto-check Cycle

Check this option, the device will update when roaming and you will incur roaming charges.

Check New Version

Click Check button for checking new version immediately.

Firewall

A firewall protects your connected devices against malicious incoming traffic from the Internet. The firewall cannot be disabled, but the following settings are available.

Port Filtering

Select **Settings > Firewall > Port Filtering**.

The MAC/IP/Port Filtering section is shown in the following figures.

Port Filtering

MAC/IP/Port Filtering Enable Disable

Apply



If you select **Enable**, and click **Apply**, the filter settings will appear as shown below:

Port Filtering

MAC/IP/Port Filtering Enable Disable
 Default Policy Accepted Dropped

Apply



MAC/IP/Port Filtering Settings

MAC Address (e.g., 00:1E:90:FF:FF:FF)
 Source IP Address
 Dest. IP Address
 Protocol
 Action Accept Drop
 Comment *

Apply



Current MAC/IP/Port filtering rules in system

<input type="checkbox"/>	MAC Address	Source IP Address	Dest. IP Address	Protocol	Source Port Range

Delete



- **Default Policy:** Set how to handle the packet if none of the rules matches.

Accepted: Internet traffic is allowed by default. Only traffic from the selected applications will be blocked from accessing the Internet. Traffic is identified by port numbers. In particular, you need to know the port numbers and the protocol (TCP, UDP) used by outgoing traffic.

Dropped: Internet traffic is blocked by default. Only traffic from the selected, pre-defined or custom applications is allowed to access the Internet.

- **MAC Address:** Set the MAC address that will be filtered.
- **Source IP Address:** Set the source IP address that will be filtered.
- **Dest. IP Address:** Set the destination IP address that will be filtered.
- **Protocol:** Set which protocol will be used for filtering.
- **Action:** Set how to handle the packet if it matches with the rule.
- **Comment:** Type a comment for the filter settings.

**NOTE:**

If rules are in conflict with each other, the first to be triggered will determine how that traffic is handled.

Click **Apply** to confirm your configuration.

Click **Delete** to delete the rule which you selected.

To add a new rule:

1. Select **Enable** in the **Port Filtering** area.
2. Click **Apply**.
3. Input the detailed information in the **MAC/IP/Port Filtering Settings** area.
4. Click **Apply** in the **MAC/IP/Port Filtering Settings** area.

Port Forwarding

You can set up virtual servers to provide services on the Internet.

Select **Settings > Firewall > Port Forwarding**

The virtual server settings is shown in the following figures.

Port Forwarding

Virtual Server Settings Enable Disable

Apply



If you select **Enable**, the Virtual Server Settings will appear.

Port Forwarding

Virtual Server Settings Enable Disable

Apply

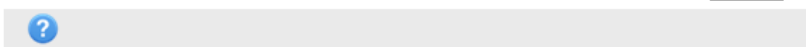

Port Forwarding Settings

IP Address * (e.g., 192.168.0.101)
Port Range * - (1~65535)
Protocol
Comment *

Apply



Current Virtual Servers in system

<input type="checkbox"/>	IP Address	Port Range	Protocol	Comment
--------------------------	------------	------------	----------	---------

Delete

- **IP Address:** Set the IP address for the virtual server.
- **Port Range:** Set port numbers for the virtual server.
- **Protocol:** Set the protocol for the virtual server.
- **Comment:** Type a comment for the virtual server settings.

Click **Apply** to confirm your configuration.

Click **Delete** to delete the rule which you selected.

To add a new rule:

1. Select **Enable** in the **Port Forwarding** area.
2. Click **Apply**.

3. Input the detailed information in the **Port Forwarding Settings** area.
4. Click **Apply** in the **Port Forwarding Settings** area.

URL Filtering

You can set up content filters to restrict the access to specific websites.

Select **Settings > Firewall > URL Filtering**

The URL Filtering is shown in the following figure:

The screenshot shows the 'URL Filtering' configuration interface. At the top, there is a title 'URL Filtering'. Below it is a text input field labeled 'URL *' with a red asterisk. To the right of the input field are two buttons: 'Apply' and 'Reset'. Below the input field is a grey bar with a blue question mark icon. Underneath is the section 'Current URL Filtering', which contains a table with one row. The row has a checkbox in the first column and the text 'URL' in the second column. To the right of the table is a 'Delete' button.

Type the URL address, and then click **Apply** to add the URL address into the filtering list. The new URL filtering item will be shown in the Current Webs URL Filters field.

UPnP

Universal Plug Play (UPnP) is a set of networking protocols that allows network devices, such as PCs, printers, Internet gateways, Wi-Fi access points and mobile devices, to seamlessly discover each other's presence on the network and establish functional network services for data sharing, communications, and entertainment.

Select **Settings > Firewall > UPnP**

The UPnP settings page is shown in the following figure.

The screenshot shows the 'UPnP Settings' configuration interface. At the top, there is a title 'UPnP Settings'. Below it are two radio buttons: 'Enable' and 'Disable', with 'Disable' selected. To the right of the radio buttons is an 'Apply' button. Below the radio buttons is a grey bar with a blue question mark icon.

Check **Enable** and click **Apply** to enable the function.

DMZ

The DMZ, or De-Militarized Zone, is a selected internal IP address of a device that allows full access and connectivity from outside traffic, through the firewall, to a specific internal device without being filtered or blocked by your device.

Select **Settings > Firewall > DMZ** and the following page will appear:

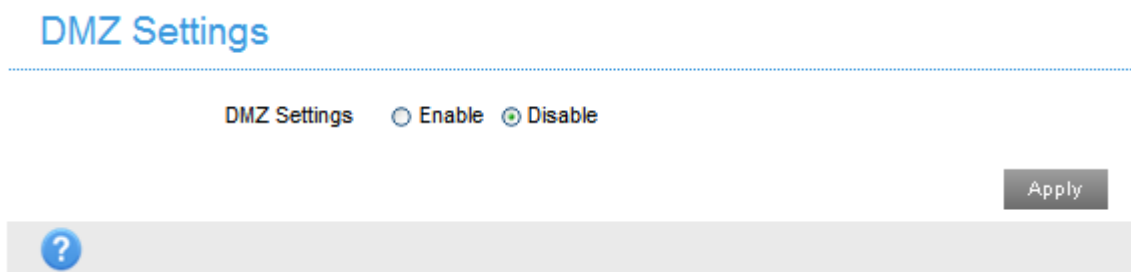

If you select **Enable**, the DMZ Settings will appear:

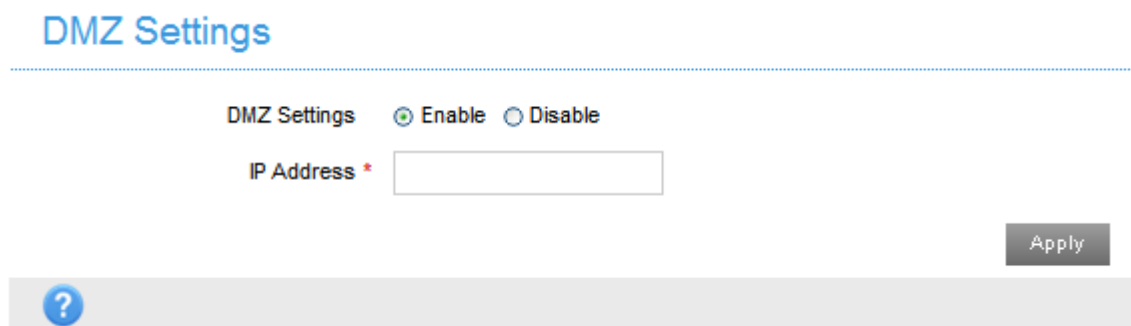

Enter the IP address of the device you want to communicate with the Internet unfiltered, and then click **Apply** to save the settings.

Router Settings

Select **Settings > Router Settings**

The router information is shown in the following figure:

Router Settings

IP Address *	<input type="text" value="192.168.0.1"/>
Subnet Mask *	<input type="text" value="255.255.255.0"/>
DHCP Server	<input checked="" type="radio"/> Enable <input type="radio"/> Disable
DHCP IP Pool *	<input type="text" value="192.168.0.100"/> - <input type="text" value="192.168.0.200"/>
DHCP Lease Time *	<input type="text" value="24"/> hour(s)



- **IP Address:** IP address for the LAN interface.
- **Subnet Mask:** Subnet mask for the IP address.
- **DHCP Server:** Enable or disable DHCP Server function.
- **DHCP IP Pool:** Allocate begin and end IP address for IP pool.
- **DHCP Lease Time:** Define how long before the leased IP address will expire. The new IP address will be reallocated after the IP address has expired.

Click **Apply** to confirm your configuration.

Information

This function allows you to view system information.

Device Information

Select **Information > Device Information** to view the device information.

Device Information

SIM Card Number	— —
IMEI	862425030000190
IMSI	— —
Signal strength	— —
Network Name(2.4GHz SSID)	Telus4B05 Change
Max Access Number(2.4GHz SSID)	10
Network Name(5GHz SSID)	Telus5G4B05 Change
Max Access Number(5GHz SSID)	10
IP Address	192.168.0.1
WAN IP Address	— —
Software Version	MF275RUIV1.2.1
Hardware Version	dgpB

Statistics

Select **Information** > **Statistics** to view usage statistics shown in the following figure:

Statistics

	Upload		Download	
Speed	0b/s		0b/s	

	Duration	Downloaded	Uploaded	Total Used Data
Current Connection	00:00:00	0B	0B	0B
Current Month	41:54:29	128.73MB	2.14MB	130.87MB

• Data usage is approximate only. For actual usage, please refer to your network operator.

Data Limit Settings

Select **Information** > **Data Limit Settings**.

Data Limit Settings

Data Use Limit Enable Disable



If you select **Enable**, the Data Limit Settings will appear.

Data Limit Settings

Data Use Limit Enable Disable

Limit by Data Time

Monthly * hour(s)

Remind me * %



- **Limit by:** Select a way to limit the data use, by data amount or time.
- **Monthly:** Set data limit for a month. If you set the limit by data, you need to select the data unit from the drop-down list; if you set the limit by time, you need to enter the time directly.
- **Remind me:** Set a percentage to remind you when the data/time reaches the specified percentage.

SMS

This function allows you to receive messages from your ISP.

Operating Messages in Native

You can check the messages saved in your device.

Device SMS

Select **Messages > Device SMS** to access the following figure:

Device SMS (0/100)



All the received messages saved in your device will be displayed here.

Click **Delete** to delete the selected messages.

Select the checkbox next to **Delete** to select all the messages saved in your device and then click **Delete** to delete them.

Click **Refresh** to refresh manually.

Operating Messages in micro-SIM Card

You can check the messages saved in your micro-SIM card.

SIM SMS

Select **Messages > SIM SMS** to access the following figure:



All the received messages saved in the micro-SIM card will be displayed here.

Click **Delete** to delete the selected messages.

Check the checkbox next to **Delete** to select all the messages in micro-SIM card and then click **Delete** to delete them.

Configuring Messages

Select **Messages > SMS Settings**

You are allowed to set the SMS centre number here.

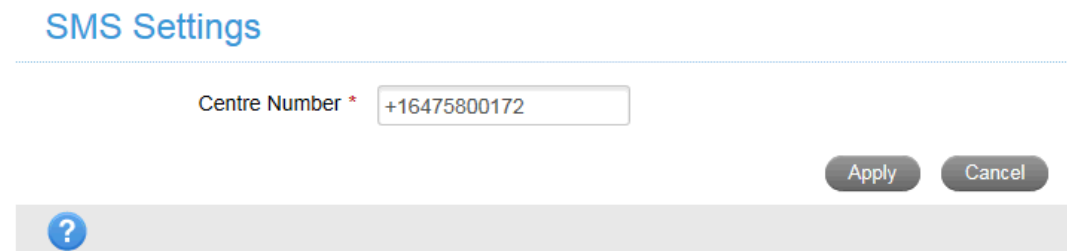

Warning and Notice

Safety Precautions

- Some electronic devices may be susceptible to electromagnetic interference. Locate the device away from TV set, radio and other electronic equipment to avoid electromagnetic interference.
- The device may interfere with medical devices like hearing aids and pacemakers. Consult a physician or the manufacturer of the medical device before using the device.
- Please keep yourself at least 20 centimeters away from device.
- Do not use your device in dangerous environments such as oil terminals or chemical factories where there are explosive gases or explosive products being processed.
- Please use original accessories or accessories that are authorized by ZTE. Unauthorized accessories may affect the device performance, damage the device or cause danger to you.
- Do not attempt to dismantle the device. There are no user serviceable parts.
- Do not allow the device or accessories to come into contact with liquid or moisture at any time. Do not immerse the device in any liquid.
- Do not place objects on top of the device. This may lead to overheating of the device.
- The device must be placed in ventilated environment for use.
- Do not expose the device to direct sunlight or store it in hot areas. High temperature can shorten the life of electronic devices.
- Do not allow children to play with the device or charger.
- Keep the length of the cable between the device and the phone less than 10 meters.
- The device is for indoor use only. Do not use the device outside. Do not connect telephone extensions which run outside of the building. These can result in lightning damage to your unit.

Cleaning and Maintaining

- Use an antistatic cloth to clean the device. Do not use chemical or abrasive cleanser as these could damage the plastic case. Turn off your device before you clean it.
- Use the device within the temperature range of $-10^{\circ}\text{C} \sim +55^{\circ}\text{C}$, and the storage temperature range is $-20^{\circ}\text{C} \sim +65^{\circ}\text{C}$. The humidity range is 5%~95%.
- Do not use your device during a thunderstorm. Remove the mains power pack from the wall socket.
- Do not take out your micro-SIM card unnecessarily. The micro-SIM card may be easily lost or it can be damaged by static electricity.

Limited Warranty

- This warranty does not apply to defects or errors in the Product caused by:
 - i. Reasonable abrasion.
 - ii. End User's failure to follow ZTE's installation, operation or maintenance instructions or procedures.

- iii. End User's mishandling, misuse, negligence, or improper installation, disassembly, storage, servicing or operation of the Product.
- iv. Modifications or repairs not made by ZTE or a ZTE-certified individual.
- v. Power failures, surges, fire, flood, accidents, actions of third parties or other events outside ZTE's reasonable control.
- vi. Usage of third-party products, or usage in conjunction with third-party products provided that such defects are due to the combined usage.
- vii. Any other cause beyond the range of normal usage intended for the Product.

End User shall have no right to reject or return the Product, or receive a refund for the Product from ZTE under the above-mentioned situations.

- This warranty is End User's sole remedy and ZTE's sole liability for defective or nonconforming items, and is in lieu of all other warranties, expressed, implied or statutory, including but not limited to the implied warranties of merchantability and fitness for a particular purpose, unless otherwise required under the mandatory provisions of the law.

Limitation of Liability

ZTE shall not be liable for any loss of profits or indirect, special, incidental or consequential damages resulting from or arising out of or in connection with using of this product, whether or not ZTE had been advised, knew or should have known of the possibility of such damages, including, but not limited to lost profits, interruption of business, cost of capital, cost of substitute facilities or product, or any downtime cost.

FCC Compliance

This device complies with part 15 of the FCC Rules. Operation is subject to the following two conditions: (1) This device may not cause harmful interference, and (2) this device must accept any interference received, including interference that may cause undesired operation.

Caution: Changes or modifications not expressly approved by the manufacturer could void the user's authority to operate the equipment.

NOTE: This equipment has been tested and found to comply with the limits for a Class B digital device, pursuant to part 15 of the FCC Rules. These limits are designed to provide reasonable protection against harmful interference in a residential installation. This equipment generates, uses and can radiate radio frequency energy and, if not installed and used in accordance with the instructions, may cause harmful interference to radio communications. However, there is no guarantee that interference will not occur in a particular installation. If this equipment does cause harmful interference to radio or television reception, which can be determined by turning the equipment off and on, the user is encouraged to try to correct the interference by one or more of the following measures:

- Reorient or relocate the receiving antenna.
- Increase the separation between the equipment and receiver.
- Connect the equipment into an outlet on a circuit different from that to which the receiver is connected.
- Consult the dealer or an experienced radio/ TV technician for help.

RF Exposure

Your device contains a transmitter and a receiver. When it is ON, it receives and transmits RF energy. When you communicate with your device, the system handling your connection controls the power level at which your device transmits.

Important safety information regarding radiofrequency radiation (RF) exposure. To ensure compliance with RF exposure guidelines the device must be used with a separation from the body. Failure to observe these instructions could result in your RF exposure exceeding the relevant guideline limits.

The maximum permissible exposure is defined in 47 CFR 1.1310 with $1\text{mW}/\text{cm}^2$. The transmitter is using external antenna that operate at 20cm or more from nearby persons. The maximum power density is $0.041\text{mW}/\text{cm}^2$.

The FCC grant can be found under the Display Grant section of <http://www.fcc.gov/oet/fccid> after searching on **FCC ID: SRQ-MF275R**.

IC

This radio transmitter (identify the device by certification number, or model number if Category II) has been approved by Industry Canada to operate with the antenna types listed below with the maximum permissible gain and required antenna impedance for each antenna type indicated. Antenna types not included in this list, having a gain greater than the maximum gain indicated for that type, are strictly prohibited for use with this device.

Immediately following the above notice, the manufacturer shall provide a list of all antenna types approved for use with the transmitter, indicating the maximum permission antenna gain (in dBi) and required impedance for each.

This device complies with Industry Canada license-exempt RSS standard(s). Operation is subject to the following two conditions:

- (1) this device may not cause interference, and
- (2) this device must accept any interference, including interference that may cause undesired operation of the device.

This Class B digital apparatus complies with Canadian ICES-003.

IC : 5200E-MF275R

IC Radiation Exposure Statement

This device complies with IC radiation exposure limits set forth for an uncontrolled environment. In order to avoid the possibility of exceeding the IC radio frequency exposure limits, human proximity to the antenna shall not be less than 20cm (8 inches) during normal operation.

Troubleshooting

Internet Related Problems

Problem	Recommended Action
The device cannot access the Internet at all.	<ul style="list-style-type: none"> • Please check your configuration settings. • Please wait 1~ 2 minutes for the device to initialize. • Check your service indicator LED's.
The download or upload speeds are very slow.	The speed is dependent on signal strength. Check your signal strength and network type.
Failing to visit the WebUI configuration page	<ul style="list-style-type: none"> • Enter the correct address. The default address is http://192.168.0.1 or http://telus.ztesmarthub. • Only use one network adapter in your PC. • Do not use any proxy server.
Failing to establish a connection between your device and a client through Wi-Fi	<ul style="list-style-type: none"> • Make sure the Wi-Fi function is active. • Refresh network list and select the correct SSID. • Check the IP address to make sure your client can obtain an IP address automatically in the Internet protocol (TCP/IP) properties. • Type the correct network key (Wi-Fi password) when you connect to the device.
About the password	<ul style="list-style-type: none"> • For the Wi-Fi connection password, please check the label on the device. • The default password of the WebUI configuration page is admin. • If you changed the password and forgot the new password, you need to restore the device to the factory default settings.

For more assistance, please:

- Visit www.ztedevices.ca
- Call the Service Hotline: +1 (866) 644-3056