



PYLONTECH

LFP Lithium Ion Energy Storage System PowerCube-M1-C Operation Manual

Information Version: AS0MPCM1C312

21P1MC0701

This manual introduces PowerCube-M1-C from Pylontech. PowerCube-M1-C is a high voltage Lithium-Ion Phosphate Battery storage system. Please read this manual before you install the battery and follow the instruction carefully during the installation process. Any confusion, please contact Pylontech immediately for advice and clarification.

Content

| | |
|---|-----------|
| 1. SAFETY | 1 |
| 1.1 Symbol..... | 2 |
| 1.2 Reference standards | 6 |
| 2. SYSTEM INTRODUCE..... | 7 |
| 2.1 Product Introduce..... | 7 |
| 2.2 Specifications | 7 |
| 2.2.1 The parameter of system..... | 8 |
| 2.2.2 Battery Module (H32148-C)..... | 9 |
| 2.2.3 Control Module | 11 |
| 2.3 System Diagram..... | 19 |
| 2.3.1 Multiple battery string parallel connection by CAN communication between MBMS and BMS diagram (battery string qty. ≤ 6) | 19 |
| 2.3.2 Multi battery string parallel connection by Ethernet communication between MBMS and BMS diagram (battery string qty. ≤ 32 set)..... | 19 |
| 2.3.3 Diagram between BMS and battery modules(external power supply):..... | 20 |
| 2.3.4 Diagram between BMS and battery modules(internal power supply):..... | 20 |
| 2. INSTALLATION | 21 |
| 3.1 Tools..... | 21 |
| 3.2 Safety Gear..... | 22 |
| 3.3 System Working Environments Checking | 22 |
| 3.3.1 Cleaning..... | 22 |

| | | |
|---------|--|----|
| 3.3.2 | Temperature..... | 23 |
| 3.3.3 | Cooling System..... | 23 |
| 3.3.4 | Heating System..... | 23 |
| 3.3.5 | Fire-extinguisher System..... | 24 |
| 3.3.6 | Grounding System | 24 |
| 3.4 | Package Items..... | 24 |
| 3.5 | Handling and placement | 27 |
| 3.5.1 | Handling and placement of the battery module | 28 |
| 3.5.2 | Handling and placement of the rack..... | 28 |
| 3.5.3 | The fix and installation of the rack | 28 |
| 3.5.4 | Install BMS and battery module..... | 28 |
| 3.5.5 | Install MBMS | 28 |
| 3.5.6 | Install Ethernet Switch | 29 |
| 3.6 | Cables connection..... | 29 |
| 3.6.1 | Caution..... | 29 |
| 3.6.2 | Cables Connection..... | 30 |
| 3.6.2.1 | CAN Communication..... | 31 |
| 3.6.2.2 | Ethernet communication | 32 |
| 3.6.3.1 | Communication for single BMS..... | 33 |
| 3.6.3.2 | CAN Communication..... | 34 |
| 3.6.3.3 | Ethernet communication | 34 |
| 3.6.3.4 | MBMS Communication Mode | 34 |
| 3.6.4 | System turns on..... | 35 |
| 3.6.5 | System turns off..... | 40 |

| | | |
|-----------|---|-----------|
| 3. | SYSTEM DEBUG | 45 |
| 4. | MAINTENANCE | 46 |
| 5.1 | Trouble Shooting:..... | 46 |
| 5.2 | Replacement of main component | 52 |
| 5.2.1 | Replacement of Battery Module | 52 |
| 5.2.2 | Replacement of Control Module (BMS) | 53 |
| 5.2.3 | Replacement of 3 rd level Control Module (MBMS) | 54 |
| 5.3 | Battery Maintenance..... | 55 |
| 5. | REMARKS..... | 57 |
| 6. | SHIPMENT | 57 |
| | ANNEX 1: CABLE CONNECTION DIAGRAM (CAN ≤6 SET) | 58 |
| | ANNEX 2: CABLE CONNECTION DIAGRAM (ETHERNET) | 59 |
| | ANNEX 3: INSTALLATION AND SYSTEM TURN ON PROGRESS LIST | 60 |
| | ANNEX 4: SYSTEM TURN OFF PROGRESS LIST | 62 |

1. Safety

The PowerCube-M1-C is a high voltage DC system, operated by authorized person only. Read all safety instructions carefully prior to any work and observe them at all times when working on with the system.

PowerCube-M1-C est un système à haute tension CC, opéré uniquement par le personnel autorisé. Lisez attentivement toutes les instructions de sécurité avant tout travail et respectez-les à tout moment lorsque vous travaillez avec le système.

Incorrect operation or work may cause:

Une opération ou un travail incorrect peut causer:

- Injury or death to the operator or a third party;
blessure ou mort à l'opérateur ou à un tiers;
- Damage to the system hardware and other properties belonging to the operator or a third party.
Dompage au matériel du système et à d'autres propriétés appartenant à l'opérateur ou à un tiers.





Skills of Qualified Person

Qualified personnel must have the following skills:





Le personnel qualifié doit avoir les compétences suivantes:

- Training in the installation and commissioning of the electrical system, as well as the dealing with hazards;
Formation en matière d'installation et de mise en service du système électrique, et de gestion des risques;
- Knowledge of the manual and other related documents;
Connaissance du manuel et d'autres documents concerné;
- knowledge of the local regulations and directives.
Connaissance des réglementations et directives locales.

1.1 Symbol

| | | |
|---|---|---|
|  | <p>Danger</p> <p><i>Danger</i></p> | <p>Lethal voltage!</p> <p><i>Tension mortelle!</i></p> <ul style="list-style-type: none"> ● Battery strings will produce high voltage DC power and can cause a lethal voltage and an electric shock. <i>La batterie produira un courant continu à haute tension et peuvent provoquer une tension mortelle et un choc électrique.</i> ● Only qualified person can perform the wiring of the battery strings. <i>Seule le personnel qualifié peut effectuer le câblage de la batterie.</i> |
|  | <p>Warning</p> <p><i>Avertissement</i></p> | <p>Risk of battery system damage or personal injury</p> <p><i>Risque d'endommagement du système de batterie ou de blessure corporelle</i></p> <ul style="list-style-type: none"> ● DO not pull out the connectors while the system is working! <i>NE PAS debrancher les connecteurs lorsque le système fonctionne!</i> ● De-energize from all multiple power sources and verify that there is no voltage. <i>Mettez hors tension toutes les sources d'alimentation et vérifiez qu'il n'y a pas de tension.</i> |
|  | <p>Caution</p> <p><i>Attention</i></p> | <p>Risk of battery system failure or life cycle reduces.</p> <p><i>Risque de défaillance ou de réduction de durée de vie du système de batterie.</i></p> |
|  | <p>Symbol in label</p> | <p>Read the product and operation manual before operating the battery system!</p> <p><i>Lisez le manuel du produit avant d'utiliser le système de batterie!</i></p> |

| | | |
|---|--------------------|---|
|  | Symbol in label | Danger! Safety! Danger ! Sécurité ! |
|  | Symbol in label | Warning electric shock! Avertissement : choc électrique ! |
|  | Symbol in label | Do not place near flammable material Ne placez pas à proximité de matériaux inflammables |
|  | Symbol in label | Do not reverse connection the positive and negative. N'inversez pas la connexion des pôles positif et négatif. |
|  | Symbol in label | Do not place near open flame Ne placez pas près d'une flamme nue |
|  | Symbol in label | Do not place at the children and pet touchable area. Ne placez pas à la portée des enfants et des animaux domestiques. |
|  | Symbol in label | Recycle label. Étiquette de recyclage. |

| | | |
|---|----------------------------|--|
|  | <p>Symbol in label</p> | <p>Label for Waste Electrical and Electronic Equipment (WEEE) Directive (2012/19/EU) Étiquette pour Directive de rebuts d'équipements électriques et électroniques (WEEE) (2012/19/UE)</p> |
|  | <p>Symbol in label</p> | <p>The certificate label for EMC. Étiquette de certificat pour EMC.</p> |
|  | <p>Symbol in label</p> | <p>The certificate label for EMC. Étiquette de certificat pour EMC.</p> |
|  | <p>Symbol in label</p> | <p>The certificate label for Safety by TÜV Rheinland. Étiquette de certificat de sécurité par TÜV Rheinland.</p> |
|  | <p>Symbol in label</p> | <p>The certificate label for Safety by TÜV Rheinland. Étiquette de certificat de sécurité par TÜV Rheinland.</p> |

Danger: Batteries deliver electric power, resulting in burns or a fire hazard when they are short



circuited, or wrongly installed.

Les piles fournissent de l'énergie électrique, ce qui entraîne des brûlures ou un risque d'incendie lorsqu'elles sont court-circuitées ou mal installées.



Danger: Lethal voltages are present in the battery terminals and cables. Severe injuries or death may occur if the cables and terminals are touched.

Des tensions mortelles sont présentes dans les bornes et les câbles de la batterie. Des blessures graves, voire mortelles, peuvent survenir si les câbles et les bornes sont touchés.



Warning: Do not open or deform the battery module;

Ne pas ouvrir ou déformer le module de batterie.

Warning: Whenever working on the battery, wear suitable personal protective equipment (PPE) such as rubber gloves, rubber boots and goggles.

Chaque fois que vous travaillez sur la batterie, portez un équipement de protection individuelle (PPE) approprié, tel que des gants en caoutchouc, des bottes en caoutchouc et des lunettes de protection.



Warning: PowerCube-M1-C system working temperature range: 10°C~40°C; Optimum temperature: 18°C~28°C. Out of the working temperature range may cause the battery system over / low temperature alarm or protection which further lead to the cycle life reduction as well as. It will affect the warranty terms as well.

Plage de température de fonctionnement du système PowerCube-M1-C: 0°C – 50°C ; température optimale: 18°C-28°C. En dehors de la plage de température de fonctionnement, la batterie risque de réduire sa durée de vie et même l'alarme de protection contre les températures trop élevées ou trop basses du système de batterie. Cela affectera la garantie.



Warning: For battery installation, the installer shall refer to NFPA70 standard for operation.

Avertissement :

Lors du montage extérieur de la batterie, le montage doit être réalisé conformément à la Norme NFPA70.



Caution: Improper settings or maintenance can permanently damage the battery.

Le réglage ou la maintenance incorrecte peuvent endommager en permanence la batterie.



Caution: Incorrect inverter parameters will lead to the premature aging of battery.

Les paramètres de l'inverseur incorrects entraîneront un vieillissement prématuré de la batterie.

1.2 Reference standards

| No | Description | Code |
|----|---|---|
| 1 | Safety standard for secondary lithium batteries | IEC62619 IEC63056 IEC62477-1 IEC62040-1 |
| 2 | UN38.3 Safe transport standard | UN38.3 |
| 3 | CE EMC Standard CE EMC Directive 2014/30/EU | EN IEC 61000-6-1:2019 EN IEC 61000-6-2:2019 EN 61000-6-3:2007+A1 EN 61000-6-4:2007+A1 IEC 61000-6-1:2016 IEC 61000-6-2:2016 IEC 61000-6-3:2006+A1 IEC 61000-6-4:2018 |
| 4 | UKCA EMC Standard | BS EN IEC 61000-6-2:2019 BS EN 61000-6-2:2005 BS EN 61000-6-4:2007+ A1 |
| 5 | Battery Cell safety standard | UL1642 |
| 6 | Battery Cell safety standard | UL1973 |
| 7 | Battery Cell safety standard | JIS C 8715-2 |
| 8 | Battery safety standard | UL9540A |
| 9 | safety standard for electrical devices CE LVD Directive 2014/35/EU | IEC62477-1 |
| 10 | Safety Standard for Lithium Battery (US) | UL1973 |
| 11 | Safety Standard for Lithium Battery (Germany) | VDE-AR-E 2510-50:2017 |

2. System Introduce

2.1 Product Introduce

PowerCube-M1-C is a high voltage battery storage system based on lithium iron phosphate battery, is one of new energy storage products developed and produced by Pylontech, it can be used to support reliable power for various types of equipment and systems. PowerCube-M1-C is especially suitable for application scene of high power, limited installation space, restricted load-bearing and long cycle life.

2.2 Specifications

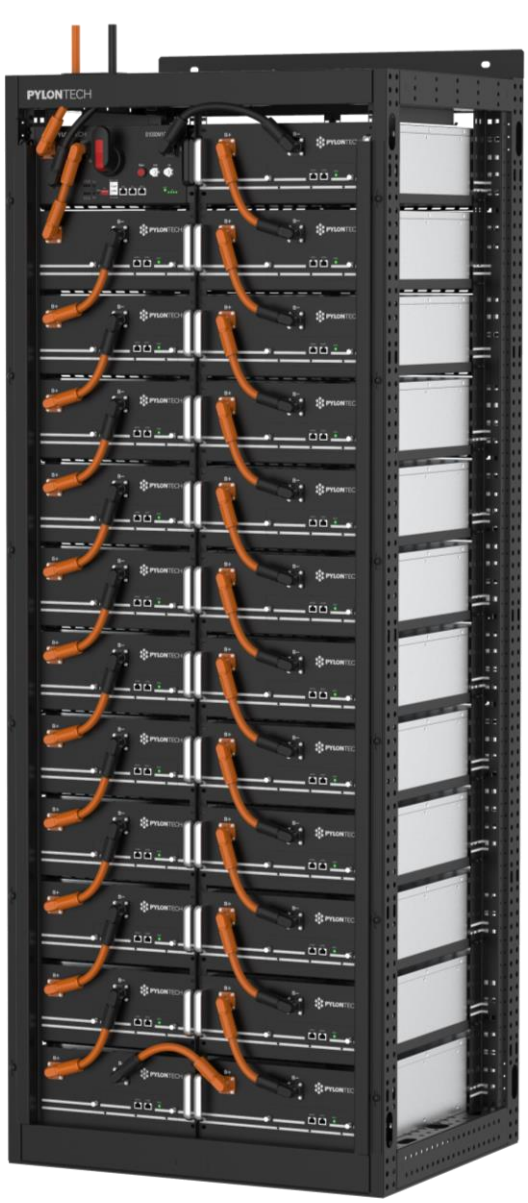
| External power supply battery system | Internal power supply battery system |
|---|--|
|  A tall, black metal rack housing a battery system. The front panel features a control panel at the top with a red emergency stop button, a digital display, and several indicator lights. Below the control panel, there are two columns of battery modules. Each module is connected to a central busbar system via orange and black cables. The rack is labeled 'PYLONTECH' at the top left. |  A tall, black metal rack housing a battery system, similar in design to the external system. It features a control panel at the top with a red emergency stop button, a digital display, and indicator lights. The battery modules are arranged in two columns, connected to a central busbar system via orange and black cables. The rack is labeled 'PYLONTECH' at the top left. |

2.2.1 The parameter of system

| Product Type | PowerCube-M1-C |
|--------------------------------------|--|
| System Voltage (Vdc) | <1000 |
| Controller Type | SC1000-200L-C (External Power Supply Version) SC1000-200J-C (Internal Power Supply Version) |
| Battery Module Type | H32148-C |
| Nominal Voltage (Vdc) | 32 × n (where n = 1~25) |
| Rated Capacity(Ah) | 148 |
| Total Storage Energy(kWh) | 4.736 × n (where n = 1~25) |
| Charge Upper Voltage (Vdc) | 36 × n (where n = 1~25) |
| Discharge Lower Voltage (Vdc) | 27 × n (where n = 1~25) |
| Nominal Current(Amps) | 74 |
| Max. Continuous Current(Amps) | 148 |
| Peak Current(Amps) | 220@15sec |
| OverCurrent/Duration(Amps/ms) | 8000/2 |
| IP Rating/Protection Class | IP20/I |
| Operation temp. range(°C) | 10 ~ 40 |
| Communication type | CANBUS/Modbus RTU/TCP/IP |
| Storage temp. range(°C) | -20 ~ 60 |
| Humidity (%) | 5 – 95 (without condensing) |
| Round-trip efficiency (% , @1C-rate) | 95 |
| Depth of Discharge (%) | 95 |
| Dimension | 815mm(W)*659mm(D)*2130mm(H)(rack for 1~23pcs) 815mm(W)*659mm(D)*2300mm(H)(rack for 1~25pcs) |
| Weight | 114+ 43×n (where n = 1~25) kg |
| Operation cycle life | >5,000 |
| Operation Life(Years) | 15+ |
| IP rating | IP20 |
| Cooling type | Natural cooling |

| | |
|----------------------|---|
| Altitude [m] | <4,000 |
| Certification | UL1973, UL9540A, IEC62477-1, IEC62040-1, IEC62619, IEC63056, UKCA, CE LVD, CE EMC, UN38.3, VDE-AR-E 2510-50 |

2.2.2 Battery Module (H32148-C)



| Product Type | H32148-C |
|-------------------------------|---------------|
| Cell Technology | Li-ion (LFP) |
| Battery Module Capacity (kWh) | 4.736 |
| Battery Module Voltage (Vdc) | 32 |
| Battery Module Capacity (AH) | 148 |
| Dimension (W*D*H, mm) | 330×628×150.5 |
| Protection Class | IP20 |
| Weight (kg) | 43 |
| Operation Cycle Life | 5,000 |
| Operation Temperature(℃) | 0~50 |
| Storage Temperature(℃) | -20~60 |
| Transportation Certificate | UN38.3 |

Battery Module (H32148-C) Front Interface

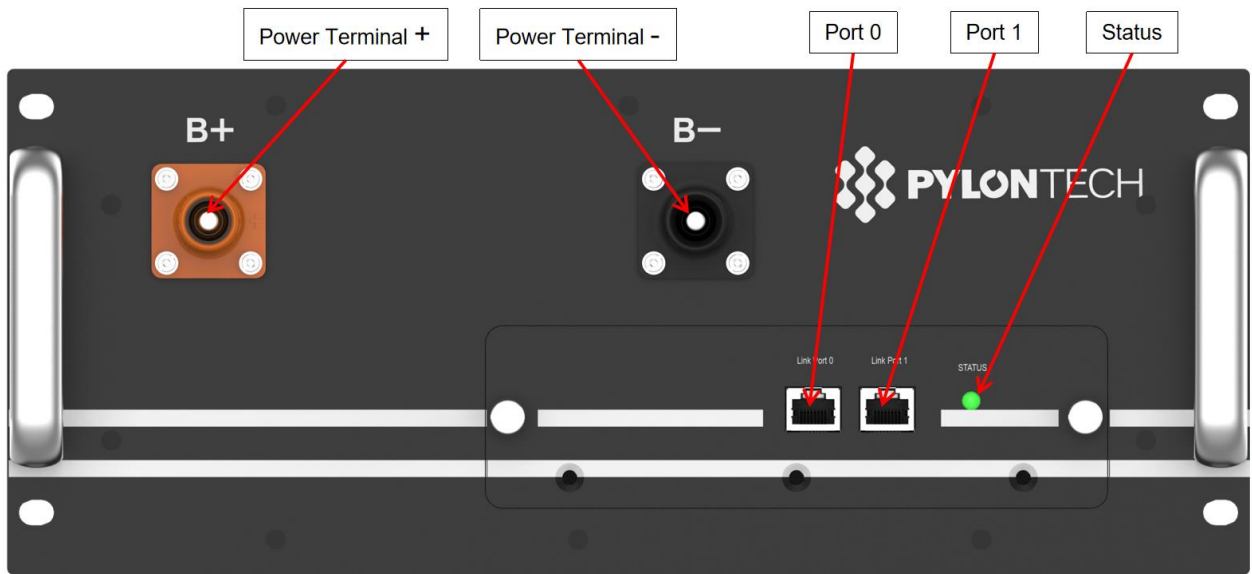

Power Terminal +/-

To connect battery series power cables.

Status

Status light: to show the battery module's status (Normal ●, Abnormal ●).

Link Port 0, 1

Link Port 0, 1 Communication Terminal: (RJ45 port), CAN communication, between multiple serial battery modules and control module.

Power Terminals

Power cable terminals: there are two pair of terminals with same function, one connect to equipment, the other one paralleling to other battery module for capacity expanding. For each single module, each terminal can achieve charging and discharging function.

For power cables uses water-proofed connectors. It must keep pressing this Lock Button during pulling out the power plug.



2.2.3 Control Module

PowerCube-M1-C's Control Module has two versions, **external** power supply or internal power supply.



SC1000-200L-C



SC1000-200J-C

| Product Type | SC1000-200L-C | SC1000-200J-C |
|--------------------------------------|--------------------|--------------------|
| Related Product | M1-C | M1-C |
| AC Supply for BMS | 230Vac/50Hz/1.3A | N/A |
| System Operation Voltage (Vdc) | 0~1000 | 0~1000 |
| Operation Current (Max.) (A) | 148 | 148 |
| Self-consumption Power-Relay Off (W) | 12 | 6 |
| Self-consumption Power-Relay On(W) | 19 | 15 |
| Dimension (W*D*H, mm) | 330×628×150.5 | 330×628×150.5 |
| Communication | MODBUS RTU\CAN\LAN | MODBUS RTU\CAN\LAN |
| Protection Class | IP20 | IP20 |
| Weight(kg) | 13 | 13 |
| Operation Life (Years) | 15+ | 15+ |
| Operation Temperature(°C) | -20~65 | -20~65 |
| Storage Temperature(°C) | -40~80 | -40~80 |

2.2.3.1 Control Module (SC1000-200L-C External power supply) Front Interface

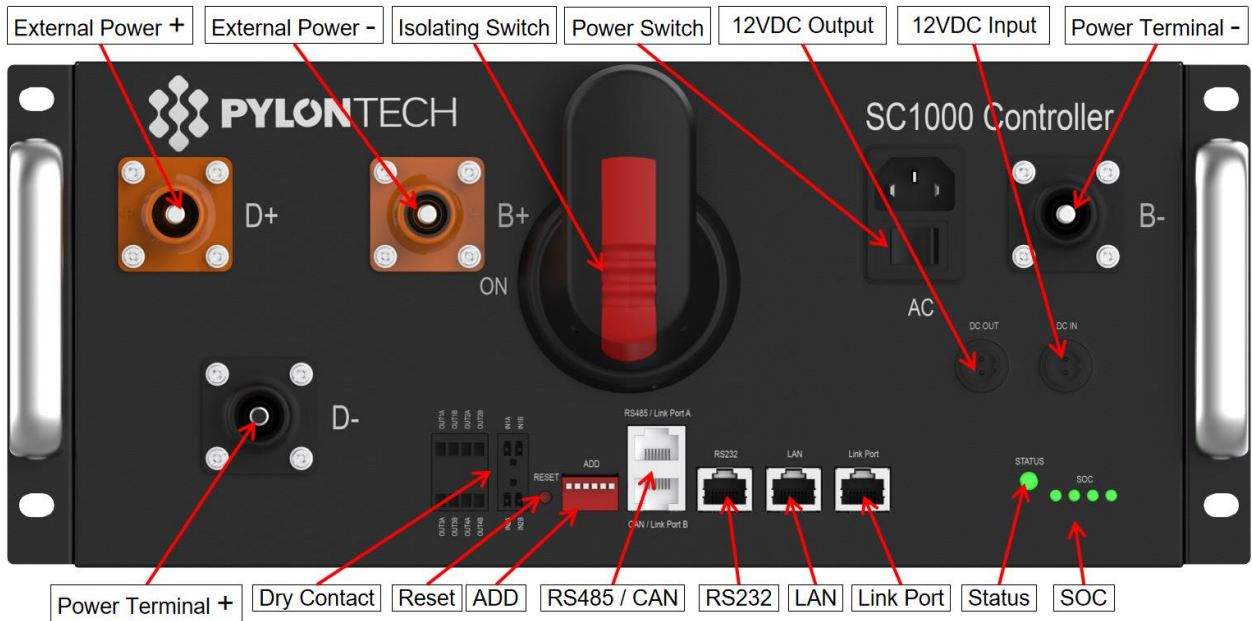

External Power Terminal D+/D-

Connect battery system with Inverter.

Power Terminal B+/B-

To connect battery power cables in series.

12VDC Output

OUT: Power supply for MBMS, to connect with MBMS' 12VDC IN.

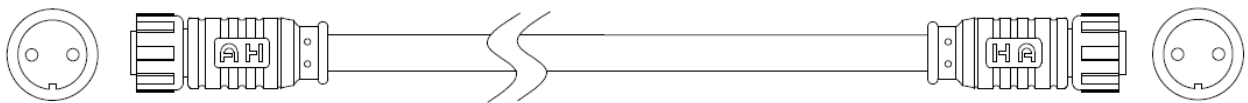

12VDC Input

In: Back-up 12VDC power supply port.

AC Input for BMS power supply

AC Socket and Control Module Power Switch: External power supply for Control Module, has an Australia or Europe or USA standard AC Power input socket. Power Switch to control ON/OFF. Applied with UPS system.

Australia Standard

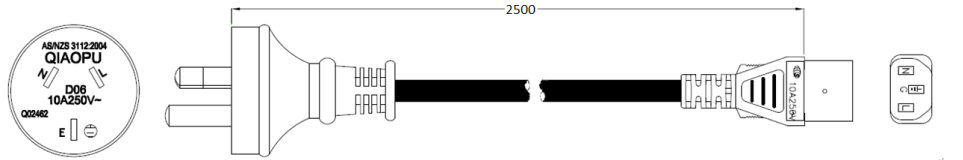

Or

Europe Standard

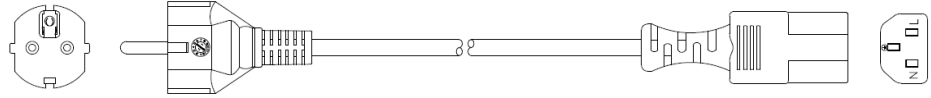

Or

USA Standard

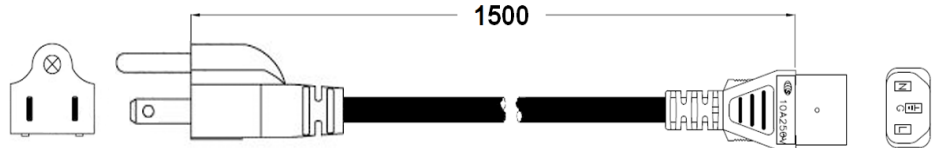

Caution: It shall be installed an AC breaker outside for AC short-circuit protection. The specifications of the breaker shall meet the system's parameters. System parameters refer to the system parameters table (chapter 2.2.1)

Attention: il doit être installé un disjoncteur CA à l'extérieur pour la protection contre les courts-circuits CA.

Power Switch

To control the BMS power supply ON/OFF

Isolating Switch

To control the high voltage DC power output ON/OFF during the Control Module Power Switch ON.

Dry Contact

Dry Contact Terminal: provided 2 input and 4 output dry contact signal.

Reset

Reset Button: Long press this button to restart the battery system.

ADD

ADD: 6 bit dial switches to manually distribute the communication address of the battery system. Nether position is OFF, means "0". Upper position is ON, means "1". 1st bit to 5th bit is for address, and the 6th bit dial switch support a 120Ω resistance.

CAN / RS485

CAN Communication Terminal: (RJ45 port) follow CAN protocol, for communication between battery system and inverter.

RS485 Communication Terminal: (RJ45 port) follow Modbus RTU/TCP/IP protocol, for communication between battery system and inverter.

RS232 Terminal

Console Communication Terminal: (RJ45 port) follow RS232 protocol, for manufacturer or professional engineer to debug or service.

LAN Terminal

Console Communication Terminal: (RJ45 port) follow Modbus protocol, used for communication between MBMS, switches or upper controller.

Link Port

Link Port Communication Terminal: (RJ45 port) follow internal protocol, for communication between multiple serial battery modules and control module.

Definition of RJ45 Port Pin

| No. | CAN | RS485 | RS232 |
|-----|------|--------|-------|
| 1 | --- | --- | --- |
| 2 | GND | --- | --- |
| 3 | --- | --- | TX |
| 4 | CANH | --- | --- |
| 5 | CANL | --- | --- |
| 6 | --- | GND | RX |
| 7 | --- | RS485A | --- |
| 8 | --- | RS485B | GND |

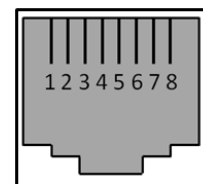

RJ45 Port

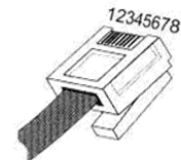

RJ45 Plug







Status

Status light: to show the battery module's status (RUN●, Alarm and Protection●).

LED Status Indicators

✧ Battery capacity indicator: 4 green lamps, each light represents 25% capacity.

LED Indicators Instructions

| Battery Status | Protection / Alarm / Normal | STATUS (green) | STATUS (red) | Capacity SOC | | | | Descriptions |
|----------------|-----------------------------|---|---|---|---|---|---|--|
| | |  |  |  |  |  |  | |
| Shut Down | | Off | Off | Off | Off | Off | Off | All off |
| Sleep | Normal | Flash2 | Off | Off | Off | Off | Off | Indicates Sleep Mode, to save the power. |
| Idle | Normal | Light | Off | Off | Off | Off | Off | Indicates save power mode. |
| | Alarm | Light | Off | Off | Off | Off | Off | Indicates the battery voltage or temperature is high or low. |
| | Protection | Off | Light | Off | Off | Off | Off | Indicates the battery voltage or temperature is over or under. |
| Charge | Normal | Light | Off | The highest capacity indicator LED flashes (flash 2), others lighting | | | | The highest capacity indicator LED flashes (flash 2), others lighting, horse race lamp when SOC >= DODH; |
| | Alarm | Light | Off | | | | | |
| | Protection | Off | Light | Off | Off | Off | Off | Stop charging, STATUS(red) lighting |
| Discharge | Normal | Flash2 | Off | Indicate based on capacity | | | | Indicate based on capacity |
| | Alarm | Flash2 | Off | | | | | |
| | Protection | Off | Light | Off | Off | Off | Off | Stop discharging, STATUS(red) lighting |
| Abnormal | Power On Fault | Off | flash 4 | Off | Off | Off | Off | Stop charging/discharging, STATUS(red) lighting |
| | Other Fault | Off | light | Off | Off | Off | Off | |
| | STL Fault | Off | flash 2 | flash 2 | | | | MCU self-check problem |

Note: The flashing instructions, flash 1 - 0.25s light / 3.75s off; flash 2 - 0.5s light / 0.5s off; flash 3 - 0.5s light / 1.5s off; flash 4 - 1s light / 1s off.

2.2.3.2 Control Module (SC1000-200J-C Internal power supply) Front Interface

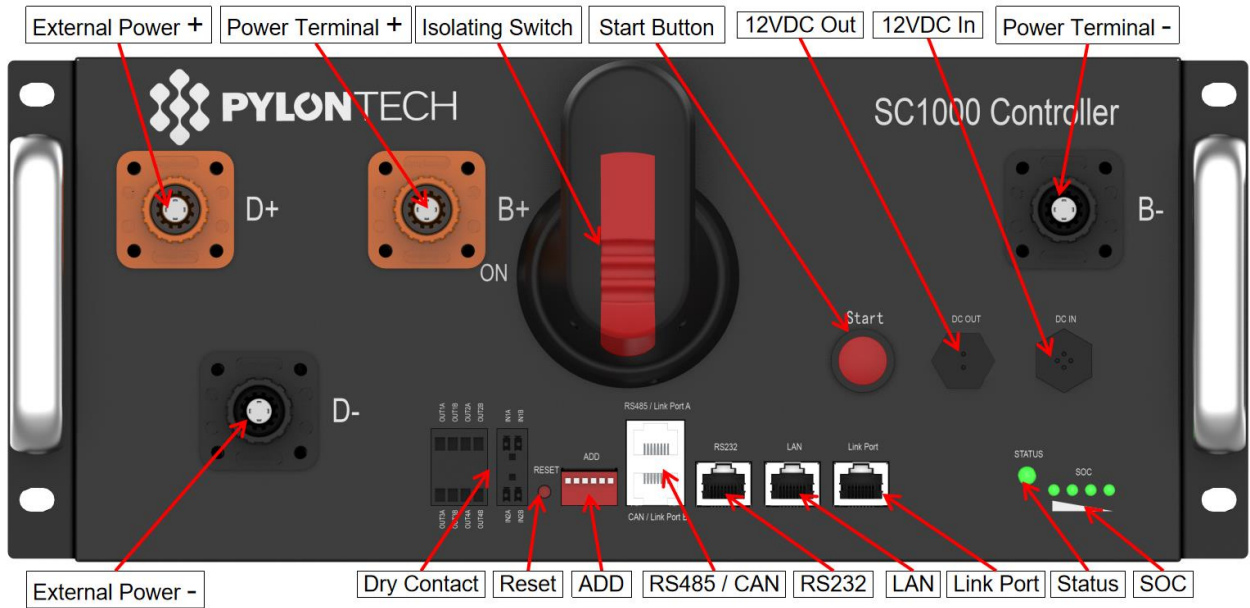

External Power Terminal D+/D-

Connect battery system with Inverter.

Power Terminal B+/B-

To connect battery power cables in series.

12VDC Out

OUT: Power supply for MBMS, to connect with MBMS' 12VDC IN.

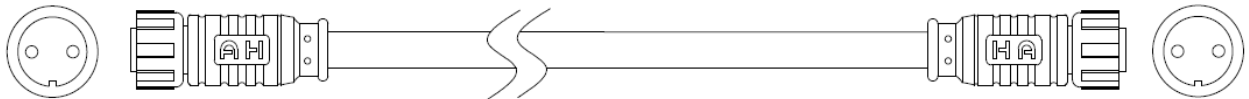

12VDC In

In: Back-up 12VDC power supply port.

Isolating Switch

To control the BMS power supply and high voltage DC power output

Start Button

Start function: press more than 5sec until the buzzer rings, to turn on controller.



Power on: Press and hold $\geq 5\text{sec}$ till the buzzer rings
Mise sous tension: Appuyez et maintenez $\geq 5\text{sec}$
 jusqu'à ce que le buzzer sonne

Black start function: If long press(>10sec) the start button 30s **AFTER** controller power on. The "STATUS" lamp will become green which means black start function is enabled. and relay will close and output for 10 min.

Dry Contact Terminal

Dry Contact Terminal: provided 2 input and 4 output dry contact signal.

Reset

Reset Button: Long press this button to restart the battery system.

ADD

ADD: 6 bit dial switches to manually distribute the communication address of the battery system. Nether position is OFF, means "0". Upper position is ON, means "1". 1st bit to 5th bit is for address, and the 6th bit dial switch support a 120 Ω resistance.

CAN / RS485

CAN Communication Terminal: (RJ45 port) follow CAN protocol, for communication between battery system and inverter.

RS485 Communication Terminal: (RJ45 port) follow Modbus RTU/TCP/IP protocol, for communication between battery system and inverter.

RS232 Terminal

Console Communication Terminal: (RJ45 port) follow RS232 protocol, for manufacturer or professional engineer to debug or service.

LAN Terminal

Console Communication Terminal: (RJ45 port) follow Modbus protocol, used for communication between MBMS, switches or upper controller.

Link Port

Link Port Communication Terminal: (RJ45 port) follow RS485 protocol, for communication between multiple serial battery modules and control module.

Definition of RJ45 Port Pin

| No. | CAN | RS485 | RS232 |
|-----|------|--------|-------|
| 1 | --- | --- | --- |
| 2 | GND | --- | --- |
| 3 | --- | --- | TX |
| 4 | CANH | --- | --- |
| 5 | CANL | --- | --- |
| 6 | --- | GND | RX |
| 7 | --- | RS485A | --- |
| 8 | --- | RS485B | GND |

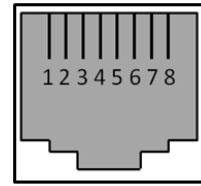

RJ45 Port

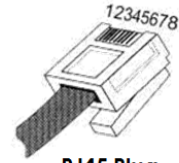

RJ45 Plug

Status

Status light: to show the battery module's status (RUN●, Alarm and Protection●).

LED Status Indicators

◇ Battery capacity indicator: 4 green lamps, each light represents 25% capacity.

LED Indicators Instructions

| Battery Status | Protection / Alarm / Normal | STATUS (green) | STATUS (red) | Capacity SOC | | | | Descriptions |
|----------------|-----------------------------|----------------|--------------|---|-----|-----|-----|--|
| | | ● | ● | ● | ● | ● | ● | |
| Shut Down | | Off | Off | Off | Off | Off | Off | All off |
| Sleep | Normal | Flash2 | Off | Off | Off | Off | Off | Indicates Sleep Mode, to save the power. |
| Idle | Normal | Light | Off | Off | Off | Off | Off | Indicates save power mode. |
| | Alarm | Light | Off | Off | Off | Off | Off | Indicates the battery voltage or temperature is high or low. |
| | Protection | Off | Light | Off | Off | Off | Off | Indicates the battery voltage or temperature is over or under. |
| Charge | Normal | Light | Off | The highest capacity indicator LED flashes (flash 2), others lighting | | | | The highest capacity indicator LED flashes (flash 2), others lighting, horse race lamp when SOC >= DODH; |
| | Alarm | Light | Off | | | | | |
| | Protection | Off | Light | Off | Off | Off | Off | Stop charging, STATUS(red) lighting |
| Discharge | Normal | Flash2 | Off | Indicate based on capacity | | | | Indicate based on capacity |
| | Alarm | Flash2 | Off | | | | | |
| | Protection | Off | Light | Off | Off | Off | Off | Stop discharging, STATUS(red) lighting |
| Abnormal | Power On Fault | Off | flash 4 | Off | Off | Off | Off | Stop charging/dischargin |

| | | | | | | | | |
|--|-------------|-----|---------|---------|-----|-----|-----|-------------------------|
| | Other Fault | Off | light | Off | Off | Off | Off | g. STATUS(red) lighting |
| | STL Fault | Off | flash 2 | flash 2 | | | | MCU self-check problem |

Note: The flashing instructions, flash 2 - 0.5s light / 0.5s off; flash 4 - 1s light / 1s off .

2.3 System Diagram

2.3.1 Multiple battery string parallel connection by CAN communication between MBMS and BMS diagram (battery string qty. ≤ 6)

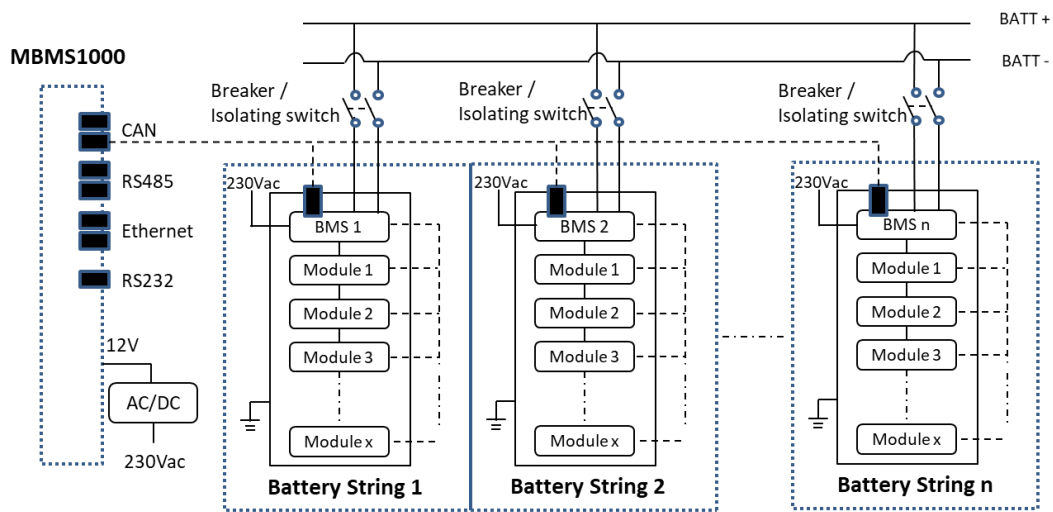

2.3.2 Multi battery string parallel connection by Ethernet communication between MBMS and BMS diagram (battery string qty. ≤ 32 set)

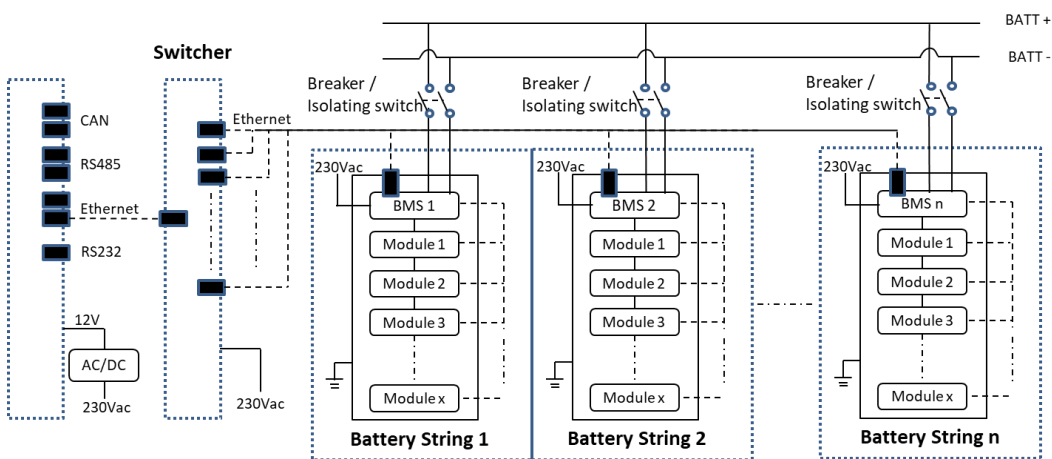

2.3.3 Diagram between BMS and battery modules(external power supply):

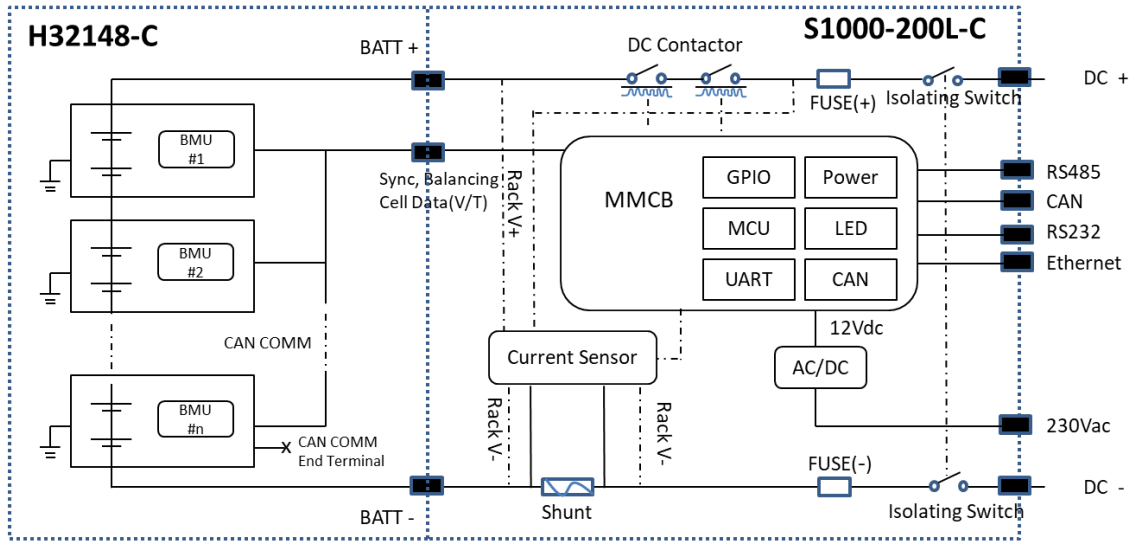

2.3.4 Diagram between BMS and battery modules(internal power supply):

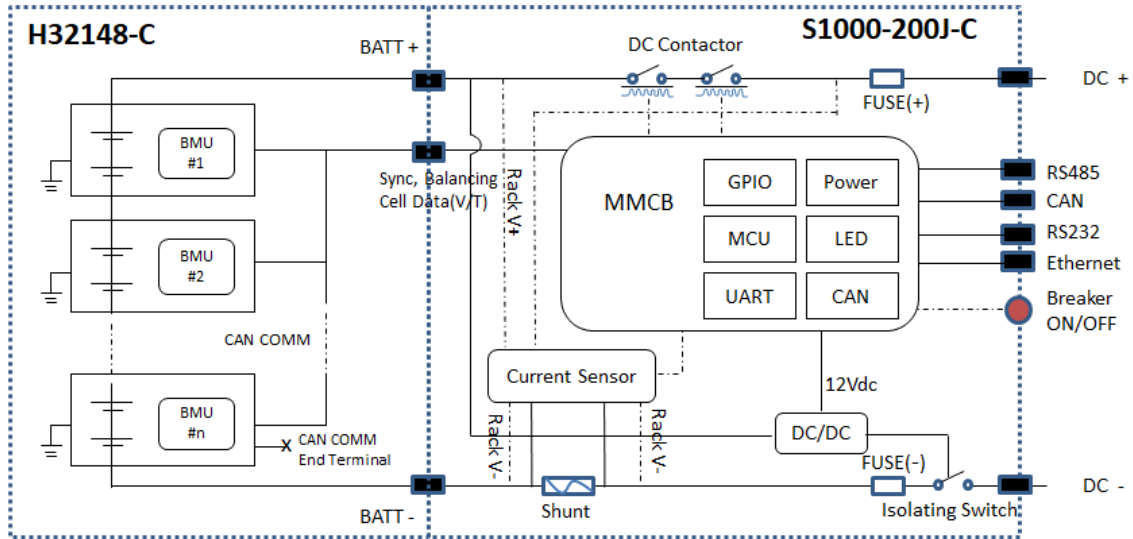









2. Installation

Please check every installation step with <Annex 2: Installation and System Turn ON Progress List> during the install.

3.1 Tools

The following tools are required to install the battery pack:

| | | |
|---|--|--|
|  <p>Wire Cutter</p> |  <p>Crimping Modular Plier</p> |  <p>Cable Ties</p> |
|  <p>Screw Driver Set</p> |  <p>Electric Screw Driver</p> |  <p>Insulating Gloves</p> |
|  <p>Adjustable Wrench</p> |  <p>1500VDC Isolating nut drivers</p> |  <p>2000VDC Multimeter</p> |

NOTE

Use properly insulated tools to prevent accidental electric shock or short circuits.

If insulated tools are not available, cover the entire exposed metal surfaces of the available tools, except their tips, with electrical tape.

3.2 Safety Gear



It is recommended to wear the following safety gear when dealing with the battery pack.

Il est recommandé de porter l'équipement de sécurité suivant lors de l'opération de la batterie.



Insulating gloves

Gants isolés



Safety goggles

Lunettes de sécurité



Safety shoes

Chaussures de sécurité

3.3 System Working Environments Checking

3.3.1 Cleaning



The battery system has high voltage connectors. The clean condition will cause the isolation characteristic of the system.

Le système de batterie a des connecteurs à haute tension. La condition de nettoyage entraînera la caractéristique d'isolation du système.

Before installation and system working must clean the dust and iron scurf to keep the environments cleaning. And the environment must have certain anti-dust ability.

Avant l'installation et le fonctionnement du système, vous devez éliminer la poussière et le copeau de fer pour maintenir l'environnement propre. Et l'environnement doit avoir une certaine capacité anti-poussière.

The system after long term running must check the humidity and dust cover or not. If heavy dust cover with high humidity on the system should stop the system running and make clean specially for the high voltage connectors.

Après une longue période de fonctionnement, le système doit vérifier l'humidité et le pare-poussière ou non. En cas de forte couverture de poussière avec une humidité élevée sur le

système, celui-ci doit être arrêté et doit être nettoyé spécialement pour les connecteurs à haute tension.



Danger: the power cables and plugs still have high voltage DC power from serial connected battery modules (battery module can't be turned off), must be careful to handle the Power Plugs.

Les câbles d'alimentation et les fiches sont toujours alimentés en courant continu à haute tension par les modules de batterie connectés en série (le module de batterie ne peut pas être désactivé), vous devez donc manipuler les fiches avec précaution.

3.3.2 Temperature

PowerCube-M1-C system working temperature range: 10°C ~ 40°C; Optimum temperature: 18°C ~ 28°C.



Plage de température de fonctionnement du système PowerCube-M1-C: 10°C-40°C; température optimale: 18°C-28°C.

Caution: Out of the working temperature range may cause the battery reduces the cycle of life even cause the battery system over / low temperature alarm or protection.

En dehors de la plage de température de fonctionnement, la batterie risque de réduire sa durée de vie et même de déclencher une alarme ou une protection contre les températures trop élevée ou trop basses.

3.3.3 Cooling System



The room must be equipped with cooling system.

La salle doit être équipée d'un système de refroidissement.

Caution: Out of the working temperature range may cause the battery reduces the cycle of life even cause the battery system over / low temperature alarm or protection.

En dehors de la plage de température de fonctionnement, la batterie risque de réduire sa durée de vie et même de déclencher une alarme ou une protection contre les températures trop élevées ou trop basses.

3.3.4 Heating System



The room must be equipped with heating system. If the environment is lower than 0°C, must turn on the heating system at first.

La salle doit être équipée d'un système de chauffage. Si la température ambiante est inférieure à 0°C, vous devez d'abord allumer le système de chauffage.

Caution: Out of the working temperature range may cause the battery reduces the cycle of life even cause the battery system over / low temperature alarm or protection.

En dehors de la plage de température de fonctionnement, la batterie risque de réduire sa durée de vie, voire de déclencher une alarme ou une protection contre les températures trop élevées ou trop basses du système de batterie.

3.3.5 Fire-extinguisher System



The room must be equipped with fire-extinguisher system for lithium-ion battery.

La salle doit être équipée d'un système d'extinction d'incendie pour batterie lithium-ion.

The fire system needs to be regularly checked to be in normal condition. Refer to the using and maintenance requirements of local fire equipment relevant.

Le système d'incendie doit être vérifié régulièrement pour être en état normal. Reportez-vous aux exigences d'utilisation et de maintenance des équipements anti-incendie locaux.

3.3.6 Grounding System



Before the battery installation must sure the grounding point of the basement is stable and reliable. If the battery system is installed in an independent equipment cabin (e.g. container), must make sure the grounding of the cabin is stable and reliable.

Avant l'installation de la batterie, vous devez vous assurer que le point de mise à la terre du sous-sol soit stable et fiable. Si le système de batterie est installé dans une cabine d'équipement indépendante (conteneur, par exemple), vous devez vous assurer que la mise à la terre de la cabine soit stable et fiable.

The resistance of the grounding system must $\leq 100m\Omega$

La résistance du système de mise à la terre doit être $\leq 100 m\Omega$.

3.4 Package Items

Accessories

The type and quantity of the accessories are subject to the battery packing list.

NOTE

Power cable uses water-proofed connectors. It must keep pressing this Lock Button during pulling out the power plug.



Unpacking and check the Packing List:

- **Internal Cable Kits for wiring connection up to Battery Controller**

| | | | |
|--|--|-----|-------|
| Power Cable + (Battery Module and Main Controller Serial Connection) | Orange/0.19m/1/0AWG/ 2 Orange Terminal | pcs | 1 pcs |
|--|--|-----|-------|

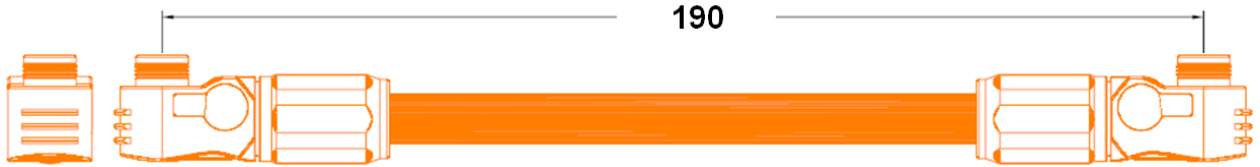

| | | | |
|--|--------------------------------------|-----|-------|
| Power Cable - (Battery Module and Main Controller Serial Connection) | Black/0.32m/1/0AWG /2 Black Terminal | pcs | 1 pcs |
|--|--------------------------------------|-----|-------|

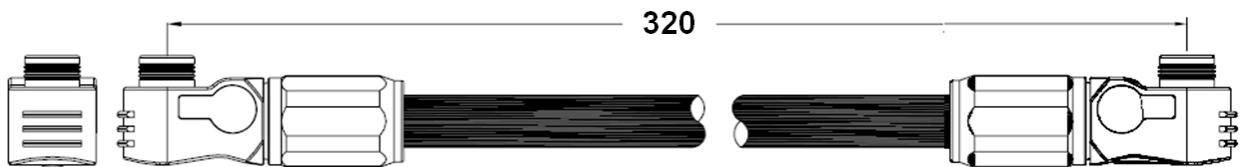

| | | | |
|--|---|-----|-------|
| Power Cable (Battery Module Left and Right rack Serial Connection) | Orange/0.35m/1/0AWG /1Orange & 1 Black Terminal | pcs | 1 pcs |
|--|---|-----|-------|

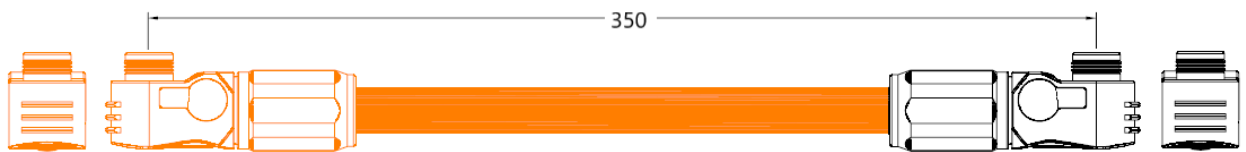

| | | | |
|--|--|-----|--------|
| Power Cable (Battery Module Upper and Lower Serial Connection) | Orange/0.24m/1/0AWG /Orange & 1 Black Terminal | pcs | 23 pcs |
|--|--|-----|--------|

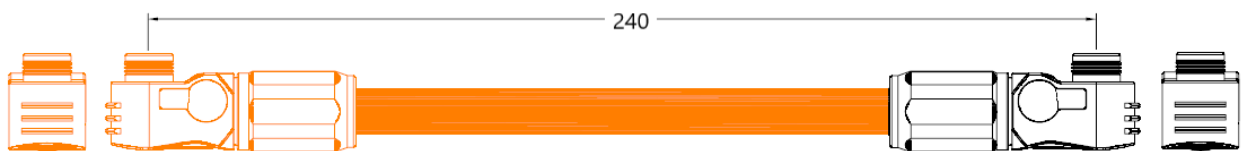

| | | | |
|---|---|-----|--------|
| Battery Cascade Communication Cable (0.18m) | Black/0.18m/8 Core Super 5th Class Twisted-pair Wire/RJ45 | pcs | 25 pcs |
|---|---|-----|--------|

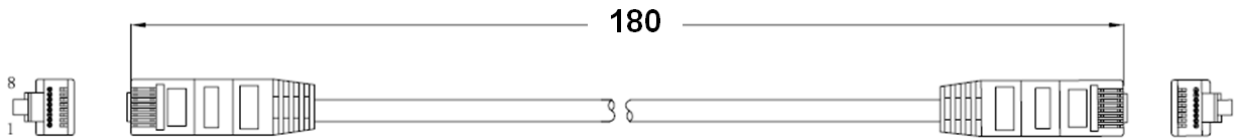

| | | | |
|---|---|-----|------|
| Battery Cascade Communication Cable (0.5m) | Black/0.5m/8 Core Super 5th Class Twisted-pair Wire/RJ45 | pcs | 1pcs |
|---|---|-----|------|

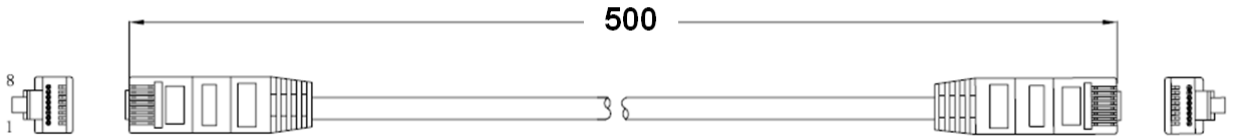

- External Cable Kits for wiring connection from Battery Controller to PCS/EMS/Power Supply

NOTE

External Cable Kits for wiring connection are available in four lengths, 3.5m/5m/7m/10m.

External Cable Kits is a separate kits externally from the battery or control module packaging.

(Communication Cable & External Power Cable).

| | | | |
|--|---|-----|------|
| External Battery CAN Communication Cable (direct) | Black/3.5m/Super 5th Class Twisted-pair Wire/2 RJ45 terminal | pcs | 1pcs |
|--|---|-----|------|

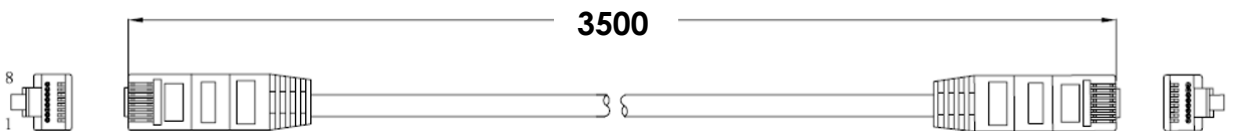

| | | | |
|------------------------|--|-----|------|
| External Power Cable + | Orange/3.5m/1/0AWG/ Phoenix Terminal/50-8 Terminal | pcs | 1pcs |
|------------------------|--|-----|------|

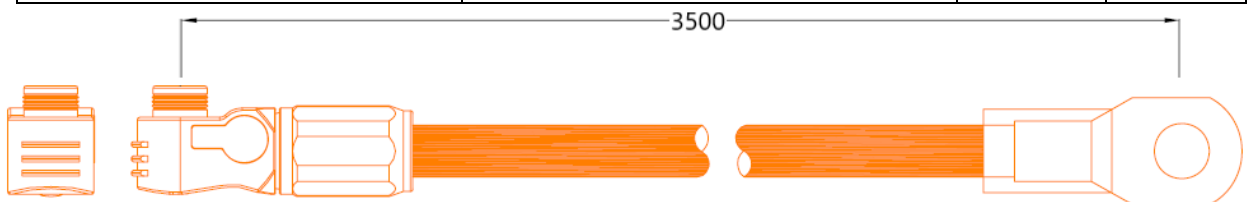

| | | | |
|------------------------|--|-----|------|
| External Power Cable - | Black/3.5m/1/0AWG / Phoenix Terminal/50-8 Terminal | pcs | 1pcs |
|------------------------|--|-----|------|

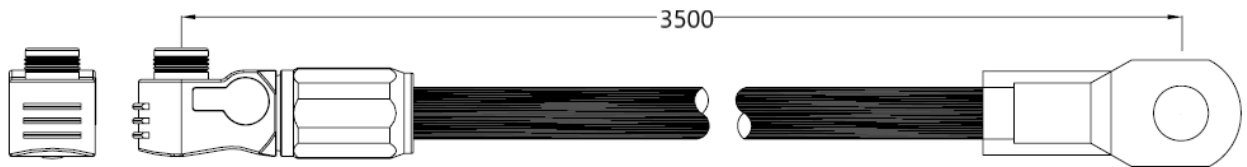

For external power supply control module(SC1000-200L-C) there is additional AC power cable:

NOTE

Ac power cables are available in two specifications: Australia Standard Or USA Standard Or Europe Standard.

| | | | |
|-------------------------------------|---|-----|------|
| AC Power Cable (Australia Standard) | Black/1.5m/3*0.75mm2/Australia Standard | pcs | 1pcs |
|-------------------------------------|---|-----|------|

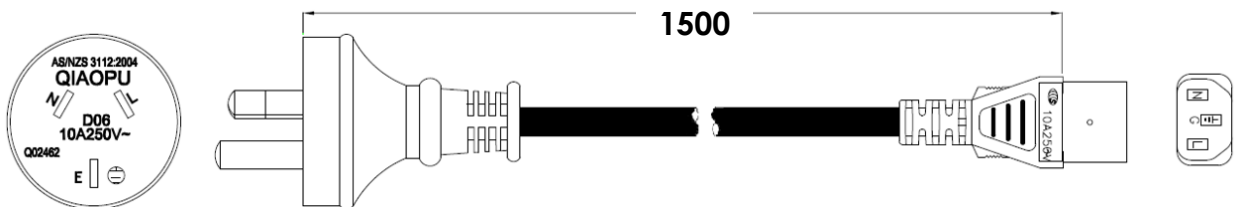

| | | | |
|-------------------------------|-----------------------------------|-----|------|
| AC Power Cable (USA Standard) | Black/1.5m/3*0.75mm2/USA Standard | pcs | 1pcs |
|-------------------------------|-----------------------------------|-----|------|

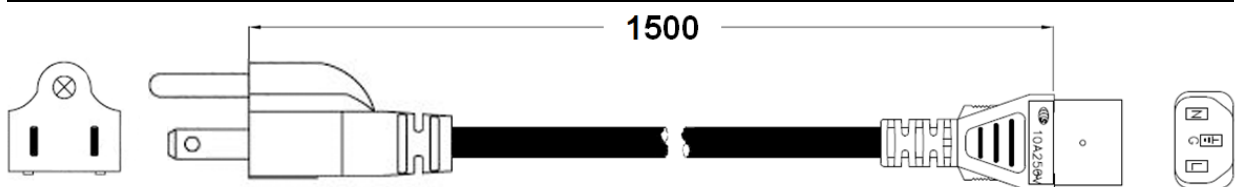

| | | | |
|----------------------------------|---------------------------------------|-----|------|
| AC Power Cable (Europe Standard) | Black/1.5m/3*0.75mm2/ Europe Standard | pcs | 1pcs |
|----------------------------------|---------------------------------------|-----|------|

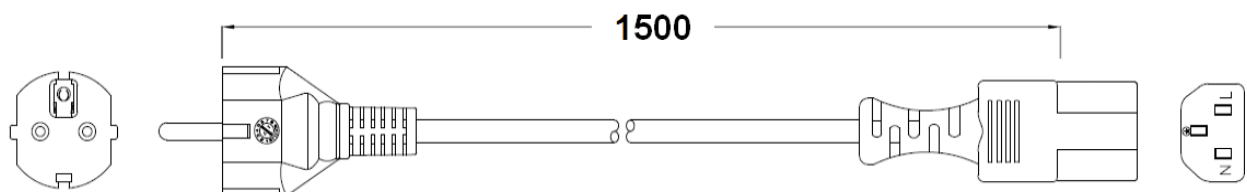

3.5 Handling and placement



Warning: The battery rack is IP00. It must be installed in a restricted access area;

Le support de batterie est IP00. Il doit être installé dans une zone d'accès restreint.

Warning: The PowerCube-M1-C is a high voltage DC system, operated by qualified and authorized person only.

PowerCube-M1-C est un système CC à haute tension, opéré uniquement par le personnel qualifié et autorisé.

3.5.1 Handling and placement of the battery module



Single battery module is 43kg. If without handling tools must more than 3 personnel to handling with it. If install in high place of the rack it must more than 4 men, or use **Lifting device.**

Un module de batterie pèse de 43kg. Sans outils de manipulation, il est nécessaire de plus de 3 hommes pour manipuler avec lui. Si vous l'installez en hauteur, il faut plus de 4 hommes.

3.5.2 Handling and placement of the rack

If without handling tools must more than 4 personnel to handling with it.

3.5.3 The fix and installation of the rack

The rack must be fixed on the basement and secure on the wall with M20 screws (use 30mm sleeve).

Battery rack basement holes bitmap (unit: mm):

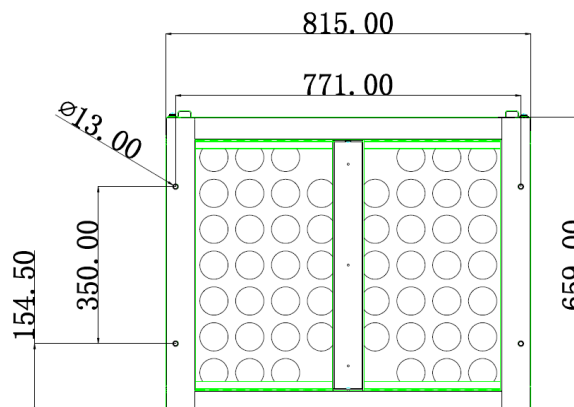

3.5.4 Control Module (BMS) and all Battery Modules install into the Rack

- Dismantle the **rack metal strip** (on the left side and right side of the rack). After installed the control module (BMS) and all battery modules need install the metals strips back for security.
- Install the **buckle nuts**. The position of nuts must meet the position of the control module (BMS) and all battery modules.
- Install the control module (BMS) and all battery modules in. Each module uses 4 **screws** to fix it.

3.5.5 Install the MBMS into a 19' standard rack [If configured]

- Install the **buckle nuts**. The position of nuts must meet the position of the MBMS.

- Install the MBMS in. Uses 4 **screws** to fix it.

3.5.6 Install the Ethernet Switch into a 19' standard rack [If configured]

- Install the **buckle nuts**. The position of nuts must meet the position of the Ethernet Switch.
- Install the Ethernet Switch in. Uses **4 screws** to fix it.

3.6 Cables connection

3.6.1 Caution:



Danger: The battery system is high voltage DC system. Must make sure the grounding of the rack is stable and reliable.

Le système de batterie est un système CC à haute tension. Vous devez vous assurer que la mise à la terre du rack soit stable et fiable.



Danger: All the plugs and sockets of the power cables must be **orange to orange and black to black**. Otherwise it will cause personal injury.

*Toutes les fiches et prises des câbles d'alimentation doivent être **orange à orange et noir à noir**. Sinon, cela causera des blessures.*



Danger: Isolation breakers or switches for each battery string must be installed for maintenance.

Un disjoncteur d'isolement ou un commutateur doivent être installés pour chaque batterie.



Danger: No short circuit or reserved connection of the battery system's anode and cathode.

Toutes les fiches et prises des câbles d'alimentation doivent être orange à orange et noir à noir. Sinon, cela causera des blessures.



Caution: Wrong communication cables connection will cause the battery system failure.

Une mauvaise connexion des câbles de communication entraînera une défaillance du système de batterie.

Grounding



The PowerCube-M1-C modules' grounding is based on metal directly touch between the module's surface and rack's surface. So it needn't grounding cables at all. If uses normal rack, remove the paint at the corresponding place.

La mise à la terre des modules PowerCube-M1-C repose sur le contact direct des métaux entre la surface de module et celle du rack. Il n'est donc pas nécessaire de mettre les câbles à la terre. Si vous utilisez un rack normal, il est possible d'enlever la peinture aux positions correspondantes.

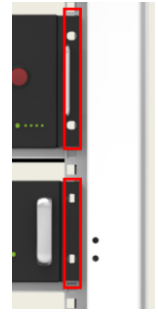

Rack Grounding:

If there is a grounding metal frame outside the rack, for example, the metal angle steel frame at the bottom of the container, the fix hole of the fix frame can be fixed directly with the metal frame of the container. Then through the grounding of the container to ensure reliable grounding.

The cable shall be copper with yellow-green color.

The ground cable can also be connected from the M8 grounding bolt on the frame base.

Grounding cable must be $\geq 6\text{AWG}$.

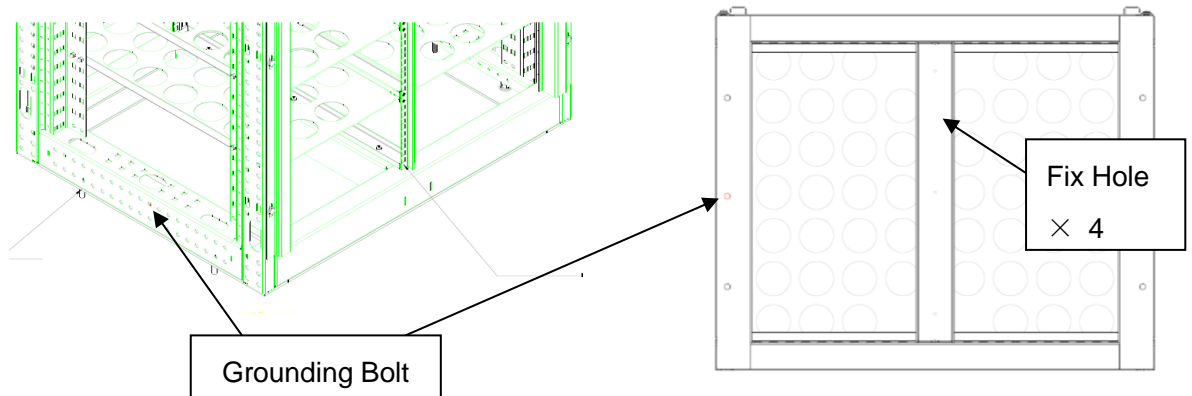

3.6.2 Cables Connection

Note: Power cable uses water-proofed connectors. It must keep pressing this Lock Button during pulling out the power plug.



3.6.2.1 CAN Communication Mode between MBMS and BMS (battery string qty. ≤ 6 set)
(battery string qty. ≤ 6 set)

When system configured PowerCube-M1-C ≤ 6 set. The communication between PowerCube-M1-C uses CAN communication mode. The communication between the MBMS and the BMS of 1st PowerCube-M1-C uses CAN communication mode.

12V DC Power Cable of AC/DC Adaptor to AC output socket of the UPS

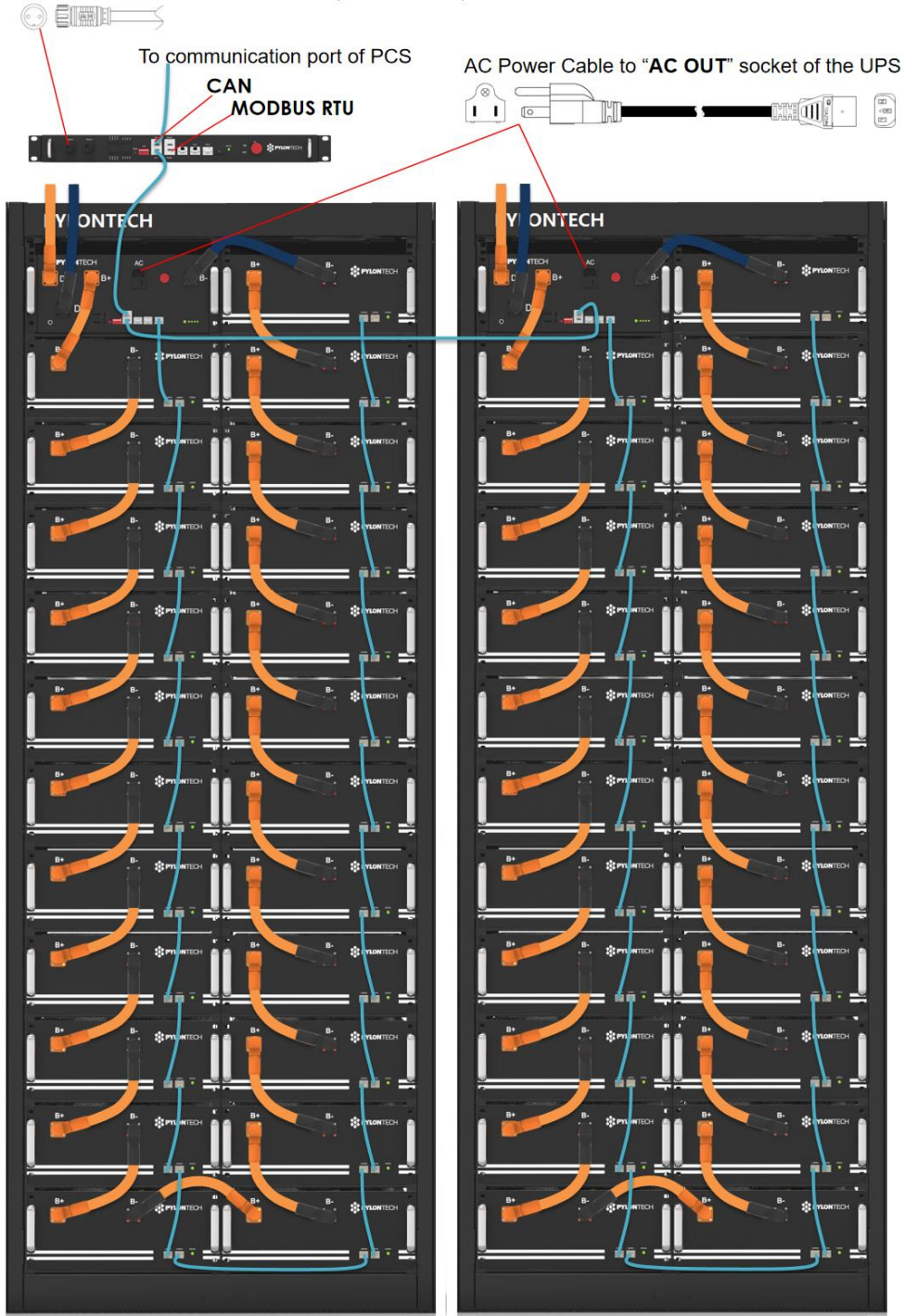

Note: The 1st PowerCube-M1-C should be installed nearest by the MBMS.

3.6.2.2 Ethernet communication between MBMS and BMS (battery string qty ≤ 32 set)

- A. When system configured PowerCube-M1-C ≤ 32 set. The communication between PowerCube-M1-Cs and MBMS uses Ethernet Switch by LAN communication.

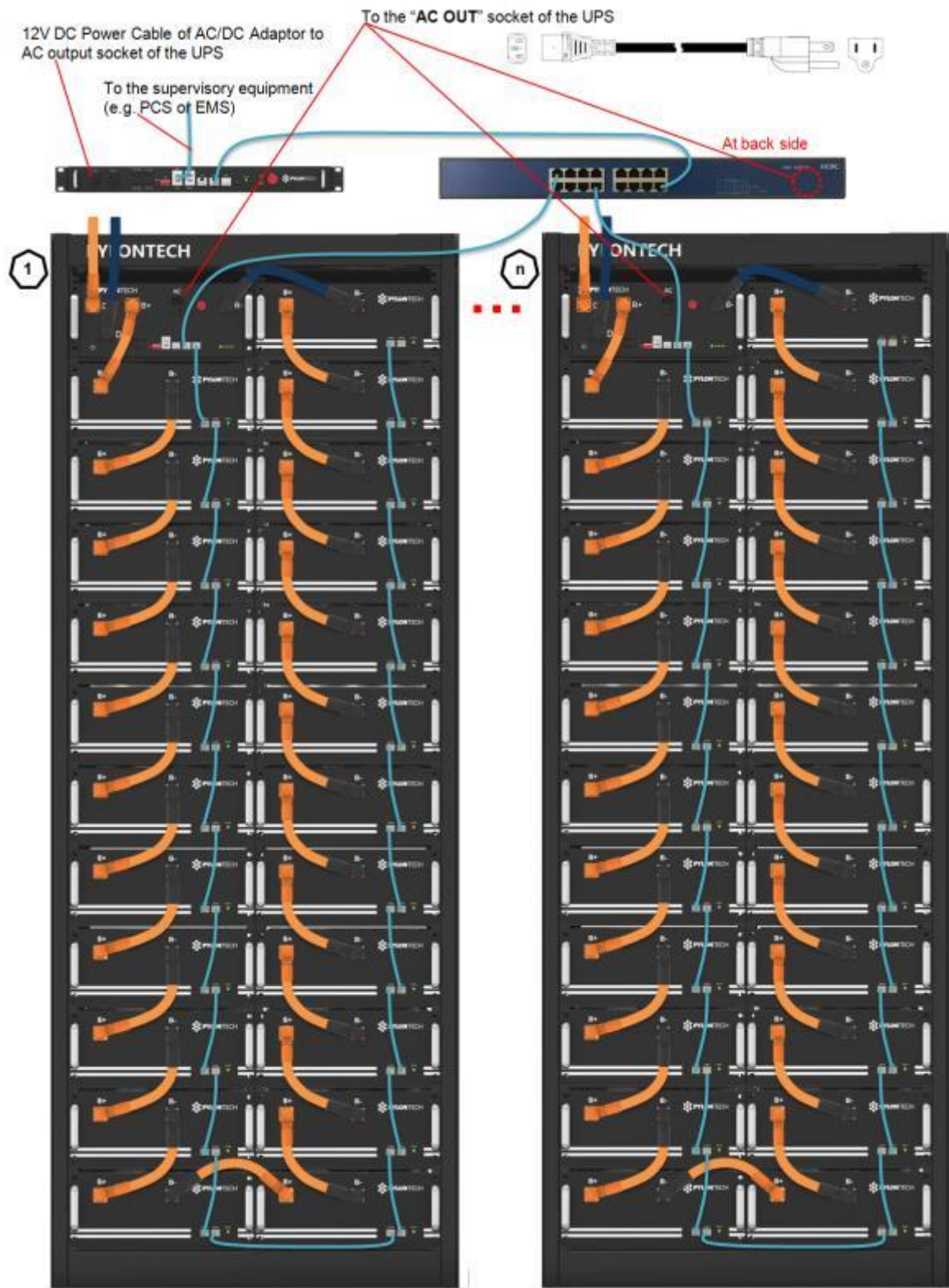

- B. Relation of MBMS and battery strings (PowerCube-M1-Cs) in the ports of Ethernet Switch

The both side of BMS to MBMS communication cable must be marked with labels.

Les deux côtés du câble de communication de BMS à MBMS doivent être marqués avec des étiquettes.



The last port of Ethernet Switch is for the MBMS.

Les deux côtés du câble de communication de BMS à MBMS doivent être marqués avec des étiquettes.



From the 1st port to the nth port are for the corresponding battery string (PowerCube-M1-C).

So we can fastest find out the corresponding battery string on the Ethernet Switch.

Du 1er port au nème port correspondent à la chaîne de batterie correspondante (PowerCube-M1). Ainsi, nous pouvons trouver rapidement la chaîne de batterie correspondante sur le commutateur Ethernet.

3.6.3 ADD Switch Setting (Address Assignment)

ADD Switch - Battery Controller is a 6 bit dial switches to manually distribute the communication address of the battery system. Down position is OFF, means "0". Up position is ON, means "1". 1st bit to 5th bit is for address, and the 6th bit dial switch support a 120 Ω resistance (**Terminal Resistance**).



ADD Switch - MBMS is a 6 bit dial switches to manually distribute the communication address of the battery system. Down position is OFF, means "0". Up position is ON, means "1". 1st bit to 4th bit is for address, the 5th and the 6th bit dial switch support a 120 Ω resistance (Terminal Resistance).

3.6.3.1 Under communication for single BMS (battery string qty. 1 set)

The BMS's first five bits must set in below **<BMS's Address Configure Table>**. The last BMS's terminal resistance must set in "1" (X=1);

The address is configured follow ASCII code: ("X" is terminal resistance).



BMS's Address Configure Table:

| CAN | Modbus | Address dial bit |
|-----|--------|------------------|
| 0 | 1 | 00000X |
| 1 | 1 | 10000X |
| 2 | 2 | 01000X |
| 3 | 3 | 11000X |
| 4 | 4 | 00100X |
| 5 | 5 | 10100X |
| 6 | 6 | 01100X |

3.6.3.2 Under CAN Communication Mode between MBMS and BMS (battery string qty. s6 set)

The BMS's first five bits must set in below <**BMS's Address Configure Table**>. The last BMS's terminal resistance must set in "1" (X=1), and other BMS's terminal resistance must set in "0".

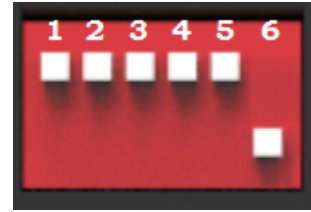

The address is configured follow ASCII code: ("X" is terminal resistance).

BMS's Address Configure Table:

The MBMS's ADD Switch set with "000011". The last 2 bits are terminal resistances.

Note: the 1st to 4th bit dial for MBMS refer to 3.6.3.4.

| Battery String | Address Bit |
|----------------|-------------|
| 1 | 10000X |
| 2 | 01000X |
| 3 | 11000X |
| 4 | 00100X |
| 5 | 10100X |
| 6 | 01100X |

3.6.3.3 Under Ethernet communication between MBMS and BMS (battery string qty. 1~32 set)

The BMS's first five bits must set in above <**BMS's Address Configure Table**>. The BMS' terminal resistance must set in "0".



The address is configured follow ASCII code: ("X" is terminal resistance).

BMS's Address Configure Table:

| Battery String | Address Bit | Battery String | Address Bit | Battery String | Address Bit | Battery String | Address Bit |
|----------------|-------------|----------------|-------------|----------------|-------------|----------------|-------------|
| 1 | 10000X | 9 | 10010X | 17 | 10001X | 25 | 10011X |
| 2 | 01000X | 10 | 01010X | 18 | 01001X | 26 | 01011X |
| 3 | 11000X | 11 | 11010X | 19 | 11001X | 27 | 11011X |
| 4 | 00100X | 12 | 00110X | 20 | 00101X | 28 | 00111X |
| 5 | 10100X | 13 | 10110X | 21 | 10101X | 29 | 10111X |
| 6 | 01100X | 14 | 01110X | 22 | 01101X | 30 | 01111X |
| 7 | 11100X | 15 | 11110X | 23 | 11101X | 31 | 11111X |
| 8 | 00010X | 16 | 00001X | 24 | 00011X | 32 | 00000X |

The MBMS's ADD Switch set with "000011". The last 2 bits are terminal resistances.

Note: the 1st to 4th bit dial for MBMS refer to 3.6.3.4.

3.6.3.4 MBMS Communication Mode

In some project it configures multi Energy Storage Systems. In this case will have multi MBMS. The address of MBMS must follow <MBMS's Address Configure Table>

| CAN | MODBUS | address dial bit 1~4 |
|-----|--------|----------------------|
| 0 | 1 | 0000 |
| 1 | 1 | 1000 |
| 2 | 2 | 0100 |
| 3 | 3 | 1100 |
| 4 | 4 | 0010 |
| 5 | 5 | 1010 |
| 6 | 6 | 0110 |
| 7 | 7 | 1110 |
| 8 | 8 | 0001 |
| 9 | 9 | 1001 |
| 10 | 10 | 0101 |
| 11 | 11 | 1101 |
| 12 | 12 | 0011 |
| 13 | 13 | 1011 |
| 14 | 14 | 0111 |
| 15 | 15 | 1111 |

3.6.4 System turns on



Double check all the power cables and communication cables. Make sure the voltage of the PCS is same level with the battery system. Check all the power switch of every battery system is OFF.

Vérifiez deux fois tous les câbles d'alimentation et les câbles de communication. Assurez-vous que la tension du PCS est identique à celle du système de batterie. Vérifiez que l'interrupteur de chaque système de batterie soit éteint.



Warning: MBMS must be turned on **AFTER** all battery strings self-check finish.

MBMS doit être activé une fois le contrôle automatique des chaînes de batterie terminé.



Warning: The external switch or breaker between PCS and battery string must be off before the battery system power on.

Un interrupteur ou disjoncteur externe entre le PC et la chaîne de batterie doit être désactivé avant que le système de batterie ne soit alimenté.

System turns on step:

- (1) Check the UPS (if has) is turned on. And the UPS is power supplying.
- (2) Switch the external power or PCS on, make sure all the power equipment can work normally.
- (3) Confirm the MBMS **is off**.
- (4) Turn on all the BMS (Battery Control Modules) as follow step:

Turn on the 1st BMS (Battery Control Modules) of battery string:

The second BMS must be operated after the first battery string's self-check is successful.

From 1st BMS to the last BMS turn on the battery strings on one by one.

For external power supply,

- 1. Turn on the "Power Switch":



- 2. Turn on the "Isolating Switch":



- 3. System start process:

The battery string's system will check itself, if work normal the battery string system will go to self-check mode.

If the BMS and all battery modules are working normally, every status LED will lighting green, that's mean self-check are pass. Self-check will be finish within 5sec.

The BMS can't receive communication from upper equipment because the communication is off, the "STATUS" lamp will light red after 30sec. That doesn't means failure existing, it means this battery string is working normally.



Warning: If has failure during the self-check, must debug the failure then can start next step.

En cas d'échec lors de l'auto-contrôle, vous devez déboguer l'échec pour pouvoir commencer à l'étape suivante.

If the "STATUS" lamp shows red from beginning, it means has failure in the battery string, the Power Relays in BMS will switch ON, must debug at first.

Si le voyant "STATUS" est rouge depuis le début, cela signifie qu'il y a une défaillance de la chaîne de batterie, les relais de puissance dans le BMS s'activent et il faut déboguer en premier.

For internal power supply,

- 1. Turn on the "Isolating Switch":



- 2. Press the "Start Button":



开机：长按至蜂鸣器响

Power on: Press and hold ≥ 5 sec till the buzzer rings

Press and hold the Start Button for more than 5sec until the buzzer rings, the LED indicator on front panel will light on if the start-up is successful;



Caution: Do not press the start button more than 30s continuously, or it will go into "BLACK-START" mode.

- 3. System start process:

The battery string's system will check itself, if power on successfully the battery string system will entering into self-check mode automatically.

If the BMS and all battery modules are working normally, every status LED will be lighting green, that's mean self-check are pass. Self-check will be finish within 10sec.

Black-start function:

If long press(>10sec) the start button 30s **AFTER** power on. The "STATUS" lamp will becomes green if the black start function is enabled. If "STATUS" lamp remain red, the black start function is failed to active, need long press start button again. System will close relay and output for 10mins.



Warning: if the black-start function is enabled, the terminal of D+ and D- will be electricity dangerous with high DC voltage output.

Les bornes D+ et D- présentent une tension de sortie en courant continu élevée et présentent un risque de mise sous tension si la fonction de démarrage en noir d'activation est activée.

Note: If the BMS can't receive communication from upper equipment because of the communication is off, the "STATUS" lamp will light red after 30sec. That doesn't mean failure existed, it means this battery string is OK while the external communication is off.

Si le BMS ne peut pas recevoir de communication de haut niveau parce que la communication est hors service, La lampe «d'état» sera rouge après 30sec. Ça veut dire que la batterie est OK pendant que la communication externe est coupée.



Warning: If has failure during the self-check, must debug the failure then can start next step.

En cas d'échec lors de l'auto-contrôle, vous devez déboguer l'échec pour pouvoir commencer à l'étape suivante.

If the "STATUS" lamp on BMS/battery shows red from beginning, it means there has some failure in the battery string, the Power Relays in BMS will open, must debug at first.

Si le voyant "STATUS" est rouge depuis le début, cela signifie qu'il y a une défaillance de la chaîne de batterie, les relais de puissance dans le BMS s'activent et il faut déboguer en premier.

Note: The LED lamp will be off in 20sec without any operation.

La lampe à LED sera éteinte dans 20 secondes sans aucune opération.

- (5) Turn on the external switches or breakers all after all the BMS turn on successful :
- (6) Switch the MBMS on:



And check MBMS is working. The "STATUS" lamp will light green.

The Power Relays in BMS will switch ON after 30 seconds, when the MBMS was turned ON.

The "STATUS" lamp of the BMS will light green;

When the voltage distance is smaller than the parameter, the battery string will do the parallel operation.

When the MBMS was turned ON, the "STATUS" lamp of the BMS will light red, but it is normal;

Note: If the MBMS can't build communication with other equipment, the system can't work normally. External Power should communicate with battery system through LAN, CAN or RS485. Otherwise maybe cause battery system work abnormal.



Caution: The whole Battery Energy Storage System (BESS), after installation or restart the system when long time not in using, should charge it to full at first.

Pour l'ensemble du système de stockage d'énergie de batterie (BESS) après l'installation ou le redémarrage du système après une longue période d'inactivité, il faut le charger complètement au début.

3.6.5 System turns off

During maintenance or long-term storage, must turn off the battery system:

For external power supply,

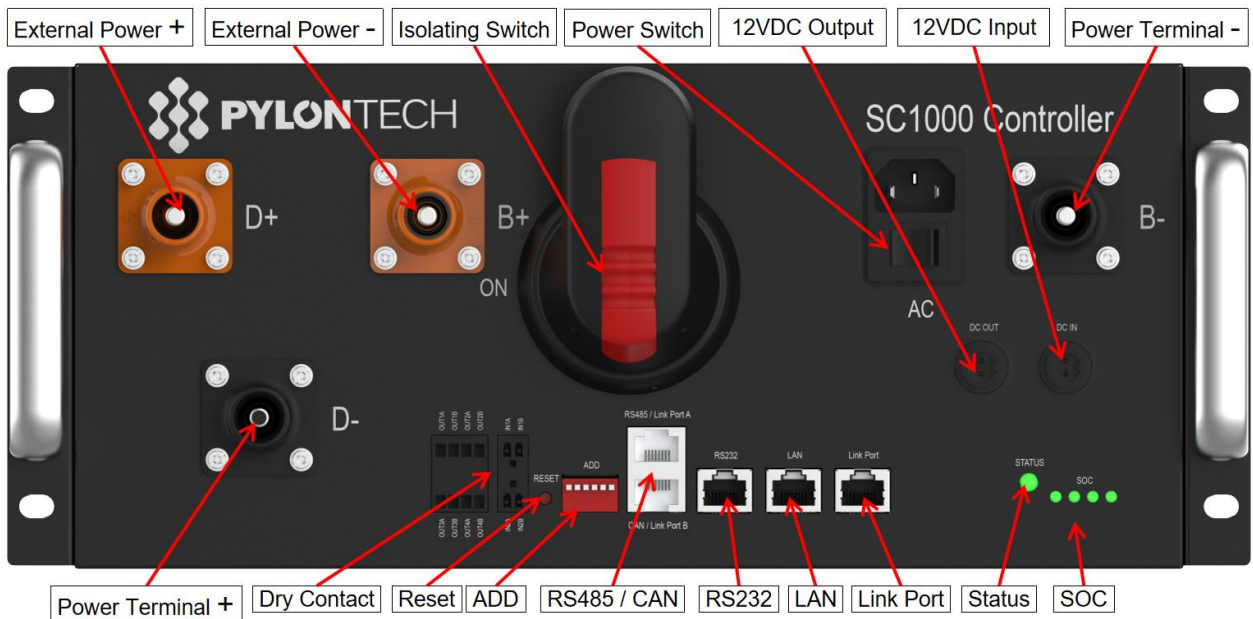

- 1) Turn off the power switch of PCS, to make sure no current through this battery string.
- 2) Turn off all the external switches or breaker between PCS and each battery strings.
- 3) Turn off the "Isolating Switch" of the BMS.
- 4) Turn off the "Power Switch" of the BMS.
- 5) Turn off the "Power Switch" of the MBMS. If the ESS configures only single battery without MBMS, so needn't this operation step.



- 6) Turn off the UPS(if has).



The UPS can turn on if have equipment must keep running can't turn off. Otherwise must turn off the UPS to save its power.

L'UPS peut s'allumer si l'équipement doit continuer à fonctionner et ne peut pas s'éteindre. Sinon, vous devez éteindre l'UPS pour économiser son énergie.



Caution: Before change the battery module for service, must charge/discharge the replaced battery same voltage to the other in system battery modules. Otherwise the system need long time to do the balance for this replaced battery module.

Avant de remplacer le module de batterie pour le service, vous devez charger/décharger la batterie remplacée à la même tension dans les modules de batterie du système. Sinon, le système a besoin d'une longue durée pour équilibrer ce module de batterie remplacé.



Warning: Do not turn off the “**Isolating Switch**” during normal running condition.

Otherwise will cause this battery string current surge by another battery strings. If turned off the “**Isolating Switch**” in normal running condition, must first turn off the PCS.

N'éteignez pas l'interrupteur d'isolation en fonctionnement normal. Dans le cas contraire, cela provoquera une surtension de la chaîne de batterie par une autre chaîne de batterie. Si le "commutateur d'isolation" est éteint en fonctionnement normal, il doit d'abord éteindre le PCS.



Warning: Do not turn off the “**Power Switch**” during normal running condition.

Otherwise will cause the DC relay of this BMS adhesion this battery string current surge by another battery strings. If turned off the “**Power Switch**” in normal running condition, must first turn off the PCS.

N'éteignez pas l'interrupteur électrique en fonctionnement normal. Sinon, cela causera le relais continu de cette adhésion BMS cette surcharge de courant de la chaîne de batterie par une autre chaîne de batterie. Si le "Power Switch" est éteint en fonctionnement normal, il faut d'abord éteindre le PCS.



For internal power supply,

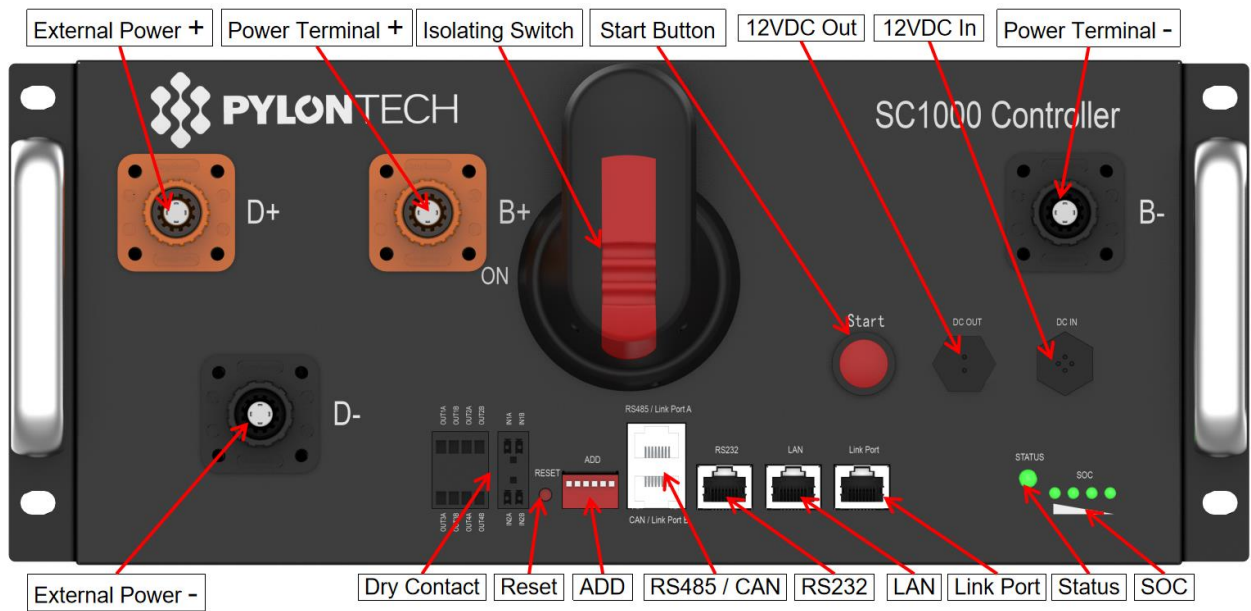

- 1) Turn off the power switch of PCS, to make sure no current through this battery string.
- 2) Turn off all the external switches or breaker between PCS and each battery strings.
- 3) Turn off the "Isolating Switch" of the BMS.
- 4) Turn off the "Power Switch" of the MBMS. If the ESS configures only single battery without MBMS, so needn't this operation step.



- 5) Turn off the UPS.



The UPS can turn on if have equipment must keep running can't turn off. Otherwise must turn off the UPS to save its power.

L'UPS peut s'allumer si l'équipement doit continuer à fonctionner et ne peut pas s'éteindre. Sinon, vous devez éteindre l'UPS pour économiser son énergie.



Caution: Before change the battery module for service, must charge/discharge the replaced battery same voltage to the other in system battery modules. Otherwise the system need long time to do the balance for this replaced battery module.

Avant de remplacer le module de batterie pour le service, vous devez charger/décharger la batterie remplacée à la même tension dans les modules de batterie du système. Sinon, le système a besoin d'une longue durée pour équilibrer ce module de batterie remplacé.



Warning: Do not turn off the “Isolating Switch” during normal running condition.

Otherwise will cause this battery string current surge by another battery strings. If turned off the “Isolating Switch” in normal running condition, must first turn off the PCS.

N'éteignez pas l'interrupteur d'isolation en fonctionnement normal. Dans le cas contraire, cela provoquera une surtension de la chaîne de batterie par une autre chaîne de batterie. Si le "commutateur d'isolation" est éteint en fonctionnement normal, il doit d'abord éteindre le PCS.



NOTE

After installation, do not forget to register online for full warranty:

www.pylontech.com.cn/service/support

3. System Debug

This system debug is for BESS system (Battery Energy Storage System). BESS system can't do the debug alone. It must operation with configured UPS, PCS and EMS system together.

| Debug Step | Content |
|--|---|
| Prepare of debug. | <p>Turn on the BESS system, refer to chapter 3. Before turn on the whole BESS system turn on the load is not allowed!</p> <p>Remark: Except the BESS, if other equipments have its own system turn on step, must follow its own system operation menu.</p> |
| System function test. | <p>Each component system debug:</p> <p>Power supply from the External Power Suppler (e.g. UPS) is working normally.</p> <p>Communication Test: Check the communication between the BESS system and communicated devices normal or not, has alarm or not.</p> <p>Power Conversion System Test: Before conjoint test must test the Inverter System turn on progress at first. And check the parameters meet BESS requirement or not.</p> <p>BESS Test: Charge/Discharge test; Test stop charging, stop discharging, current limiting functions, etc.</p> <p>Caution: Before turn on the BESS system must setup all the parameters of the PCS and EMS at first.</p> |
| Monitor function test. (If configured.) | Check the data of the BESS system is showing on the monitor system normally. |
| EMS monitoring test (If configured.) | If the EMS system has configured, check the information uniformity and command functionality follow the BMS protocol. |
| Trial operation test. | After the system debugged, run the system a period as test (testing with low load), to test the high voltage DC system is fit for the contract. |

4. Maintenance

5.1 Trouble Shooting:



Danger: The PowerCube-M1-C is a high voltage DC system, operated by qualified and authorized person only.

PowerCube-M1-C est un système à courant continu à haute tension, opéré uniquement par le personnel qualifié et autorisé.



Danger: Before check the failure, must check all the cables connection and the BESS system can turn on normally or not.

Danger : Avant le contrôle de panne, il faut contrôler toutes les connexions des câbles et si le système BESS peut s'allumer normalement ou non.

Section A Before start up:

(1) For External Power Supply BMS:

| Failure Mode | Possible Reason | Solution |
|--|-----------------------------|---|
| Battery system do not start up after power supply and correct start up procedure | External power supply issue | 1. Check external power supply condition a. Require 100 – 240Vac, 50/60Hz b. Power needed for device wake up: M1/M1C BMS – 150W M2A180 – 225W M3A100 – 360W M3A180 BMS & air fan – 1500W MBMS – 5W |
| | Power supply cable issue | 2. Use multimeter to check the power supply cable connectivity 3. Check the connection reliability |
| | PMU failure | 4. Open BMS case, use multimeter check PMU 12Vdc output and CMU LEDs. If neither is on, please swap the PMU. |
| | Other error | 5. If problem remain, contact Pylontech service engineer. |

(2) For Internal Power Supply BMS:

| Failure Mode | Possible Reason | Solution |
|--------------------------------|-------------------|--|
| Battery system do not start up | Power cable issue | 1. Check the wiring connection and connectivity of the power cables. |

| | | |
|--|----------------------|--|
| after correct wiring connection and start up procedure | Internal cable issue | 2. Open BMS case, check the connectivity and reliability of the internal power supply cable |
| | PMU issue | 3. Open BMS case, use multimeter check PMU 12Vdc output and CMU LEDs. If neither is on, please swap the PMU. |
| | Other error | 4. If problem remain, contact Pylontech service engineer. |

Section B During operation :

(1) Error Code checked from BMS (Modbus protocol Appendix IV or CAN ID 0*4250&0*4290):

*The 'Failure Definition' and 'Failure Mode' column is reference from Pylontech Modbus protocol Appendix IV Error code 1 bits to present.

| Failure Type | Failure Definition | Possible Reason | Solution |
|-----------------|---|--|--|
| External | Input RV Err (Bit4) | D+ D- reversely connected | Check the external power cables of the polarity and connection |
| External | DC OV ERR input over voltage error (Bit3) | D+ D- voltage extremely higher than battery system voltage | Check external inverter's voltage whether match with the battery system or not. |
| External | Emergency stop (Bit13) | Command by external device via dry contactor | Command by external device, not an error actively report by Battery system. |
| Current Leakage | Current Leakage Error (Bit21) | Current Leakage >25mA | 1.With insulation glove, disconnect the battery system and contact Pylontech service engineer. |
| Self-test | Self-test module Initial Error (Bit16) | Self-test failed | 1. Restart 2.If problem remain, contact Pylontech service engineer. |
| Self-test | Self-test module coulomb error (Bit15) | Self-test failed | contact Pylontech service engineer. |
| Self-test | Self-test module detecting amount error (Bit14) | Self-test failed | contact Pylontech service engineer. |
| Self-test | Safety check failure (Bit11) | Chip self-test failed | 1.Restart 2.If problem remain, contact Pylontech |

| | | | |
|--------------------|--------------------------------|--|--|
| | | | service engineer. |
| Self-test | Self-test volt error (Bit10) | Battery cell voltage measurement mismatch with DCBUS voltage measurement | <ol style="list-style-type: none"> 1. Restart 2. Check the connectivity and reliability of the power and comm. cable by reconnection. 3. Swap the current measurement board or BMS 4. If problem remain, contact Pylontech service engineer. |
| Battery cell | Battery damage error (Bit6) | Battery cell voltage measured at <2.0V | <ol style="list-style-type: none"> 1. Restart 2. Swap out the RED LED module 3. Use multimeter to measure the battery module power terminal voltage, if is the same as the BMS reading value, then it's a true cell damage. Otherwise please swap the BMU of the module. |
| Comm. and hardware | BMIC error (Bit8) | Sensor chip error | <ol style="list-style-type: none"> 1. Restart 2. If observed a module LED is off, try to bypass the module on both comm. and power side and see whether rest modules' LED could be on and green. If so, then please change the BMU of the bypassed module. If not, further bypass the next LED off module and repeat the process. 3. If problem remain, contact Pylontech service engineer. |
| Comm. and hardware | Internal Comm. ERR (Bit2) | Communication offline between module and BMS | <ol style="list-style-type: none"> 1. Check the connectivity and reliability of the comm. cable between BMS and battery modules. 2. Restart 3. If problem remain, contact Pylontech service engineer. |
| Comm. and hardware | BMU Internal bus error (Bit18) | BMU internal error | <ol style="list-style-type: none"> 1. Change the BMU of the RED LED module. 2. If problem remain, contact Pylontech service engineer. |
| Comm. and hardware | BMS Internal bus error (Bit9) | CMU internal error or I2C issue | <ol style="list-style-type: none"> 1. Restart 2. Change the current measurement board 3. Change the CMU or BMS. 4. If problem remain, contact Pylontech service engineer. |

| | | | |
|----------|---------------------------------|--|---|
| Hareware | Shutdown circuit error (Bit7) | Cannot completely switch off the system during self-protection | 1.Change PMU 2.If problem remain, contact Pylontech service engineer. |
| Hareware | Relay Error (Bit5) | 1.Start-up procedure problem 2. Relay adhesion 3. Relay damage | 1. Completely switch off inverter and battery system. Make sure DCBUS has no voltage. 2. Switch on each BMS first before switch on the MBMS. After the battery system finish self-test(require ~3mins), switch on the inverter. 3. Change the relay or BMS. 4.If problem remain, contact Pylontech service engineer. |
| Hareware | temperature sensor error (Bit1) | 1. Sensor cable issue 2. Sensor connection issue | 1.Change the RED LED module`s BMU 2. Check the temp. sensor cable connect between BMU and battery pack of the connectivity 3. Change the RED LED module. 4.If problem remain, contact Pylontech service engineer. |
| Hareware | voltage sensor error (Bit0) | 1. Sensor cable issue 2. Sensor connection issue 3.BMU issue | 1.Change the RED LED module`s BMU 2. Check the voltage sensor cable connect between BMU and battery pack of the connectivity 3. Change the RED LED module. 4.If problem remain, contact Pylontech service engineer. |

(2) Error Code checked from MBMS(Modbus protocol Appendix IV or CAN ID 0*4250&0*4290):

| Content Failure Mode | Possible reason | Solution |
|-------------------------------|---|---|
| All BMS offline error (Bit20) | 1. Battery system over discharged 2. Comm. cable issue 3. Ethernet switch issue 4. MBMS CMU issue 5. Firmware issue | 1. Check whether the batter system has been over-discharged or not via multimeter. 2. Check the comm. cables between BMS and MBMS, make sure the cable is 8PIN pin – pin CAT5 ethernet cable. If BMS and MBMS is communication via CANBUS(no ethernet switch), make sure the CANBUS physical length is less than 15m. Restart the system. 3. Check the ethernet switch condition, |

| | | |
|---|--|---|
| | | <p>completely restart the system.</p> <p>4. Reverse sequence connect the comm. cable between the BMSs and change the ADD address settings. Restart the system.</p> <p>5. Change the MBMS CMU</p> <p>6. If problem remain, contact Pylontech service engineer.</p> |
| Emergency stop (Bit13) | Command by external device via dry contactor | Command by external device, not an error actively report by Battery system. |
| Communication error between MBMS and BMS (Bit17) | <p>1. Battery string(s) overdischarged</p> <p>2. BMS CMU error</p> | <p>1. Check whether the battery string(s) has been over-discharged or not via multimeter.</p> <p>2. Check the comm. cables between BMS and MBMS, make sure the cable is 8PIN pin – pin CAT5 ethernet cable. If BMS and MBMS is communication via CANBUS(no ethernet switch), make sure the CANBUS physical length is less than 12m.</p> <p>Restart the system.</p> <p>3. Reverse sequence connect the comm. cable between the BMSs and change the ADD address settings.</p> <p>Restart the system.</p> <p>4. Change the BMS CMU or BMS</p> <p>5. If problem remain, contact Pylontech service engineer.</p> |
| Insulation fault (Bit12) | External insulation detection device reports a failure | Check the external insulation detection device. |

(3) Alarm Code checked on MBMS(Modbus protocol Appendix I-4 or CAN ID 0*4290)

| Content Alarm definition | Possible Solution | Solution |
|---|--|---|
| BMS disconnect alarm (Alarm status 2 Bit3) | BMS disconnect due to comm. offline. | If the alarm is not continuously or frequently, the system can continuous working without issue. |
| | BMS disconnect due to voltage difference between multiple racks. | 1. Restart the system and make a fully discharge of the system followed by a fully charge, in order to align the voltage of multiple racks. |
| | BMS disconnect due to BMS error. | 1.Reference from Section B (1) to troubleshoot the BMS. 2.Restart the system and make a fully discharge of the system followed by a fully charge, in order to align the voltage of multiple racks. |
| BMS communication lost alarm (Alarm status 2 Bit2) | Exist BMS offline but system can continuous operation. | 1.Reference from Section B (2) Bit 17 to troubleshoot the BMS and MBMS. 2.Restart the system and make a fully discharge of the system followed by a fully charge, in order to align the voltage of multiple racks. |

5.2 Replacement of main component



Danger: The PowerCube-M1-C is a high voltage DC system, operated by qualified and authorized person only.

PowerCube-M1-C est un système à courant continu à haute tension, opéré uniquement par le personnel qualifié et autorisé.

Danger: Before replace the main component must shut off the maintenance battery string's power. Must confirm the **D+** and **D-** terminal are without power. The turn off progress refer to chapter 3.6.5.

5.2.1 Replacement of Battery Module

A new battery module can be add onto an existing system at any time. Please make sure the new battery module has an equivalent voltage level (OCV) compare to existing modules. In a serial connection system, the new module, even has a higher SOH, will follow the system worst SOH condition module to perform.

5.2.1.1 Make sure the new battery module has an equivalent voltage level (OCV) compare to existing modules.

5.2.1.2 Shut off the whole battery string's power. Must confirm the **D+** and **D-** terminal are without power. The turn off progress refer to chapter 3.6.5.

5.2.1.3 Pull out the Plug of Power Cable +/- . Pull out the plug of communication cable.

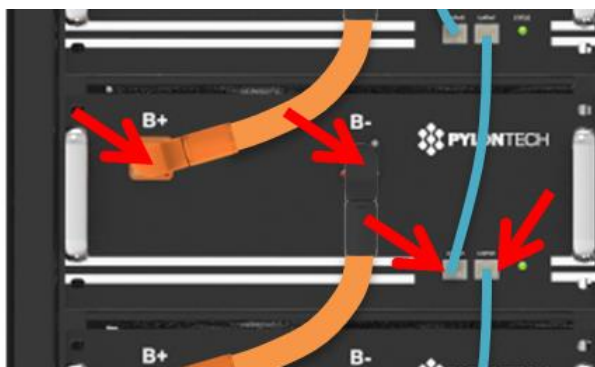

Danger: the power cables and plugs still have high voltage DC power from serial connected battery modules (battery module can't be turned off), must be careful to handle the Power plugs.

Les câbles d'alimentation et les fiches sont toujours alimentés en courant continu à haute tension par les modules de batterie connectés en série (le module de batterie ne peut pas être éteint), vous devez donc manipuler les fiches avec précaution.

5.2.1.4 Dismantle the 4 screws of the battery module's front face.

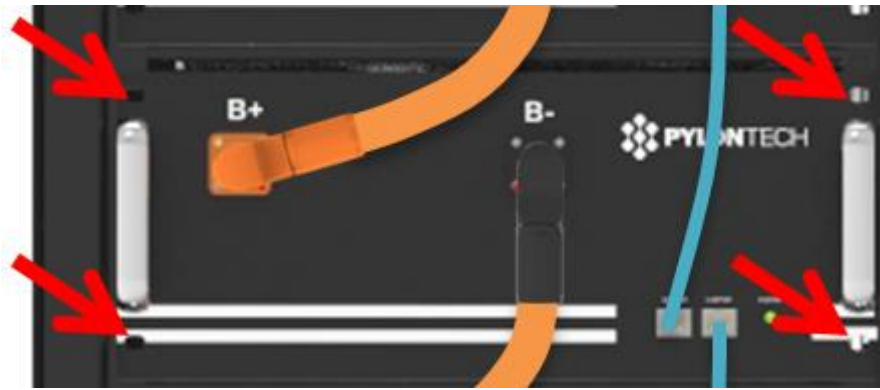

5.2.1.5 Handle the battery module out of the rack, and put it to the appoint place.



Warning: Single battery module is 43kg. If without handling tools must more than 3 personnel to handling with it. If install in high place of the rack it must more than 4 personnel.

Un module de batterie pèse 55 kg. Sans outils de manipulation, il est nécessaire de plus de 3 hommes pour manipuler avec lui. Si vous l'installez en hauteur, il faut plus de 4

5.2.1.6 Install the new battery module (see before 5.2.1.1). And connect the normal cables. Refer to chapter 3.5.

5.2.1.7 Turn on this battery string. Refer to chapter 3.6.

5.2.1.8 Make a fully charge of the system before normal operation.

5.2.2 Replacement of Control Module (BMS)

5.2.1.1 Shut off the whole battery string's power. Must confirm the **D+** and **D-** terminal are without power. The turn off progress refer to chapter 3.6.5.

5.2.2.2 Pull out the plugs of Power Cables and the communication plugs.

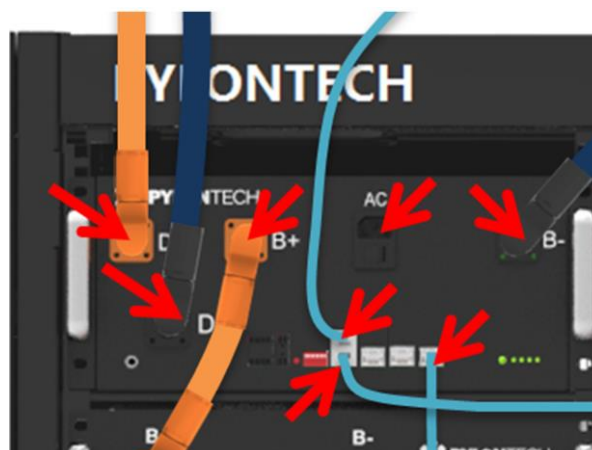



Danger: the power cables still have high voltage DC power from another battery modules, must be careful to handle the Power plugs.

Les câbles d'alimentation sont toujours alimentés en CC à haute tension par d'autres modules de batterie; vous devez manipuler les fiches d'alimentation avec soin.

5.2.2.3 Dismantle the 4 screws of the battery module's front face.



5.2.2.4 Install the new control module (BMS). And reconnect all the cables. Refer to chapter 3.5.

5.2.2.5 Turn on this battery string. Refer to chapter 3.6.



Caution: Before pull out the communication cables must mark the cable number, to avoid cable wrong sequence.

Avant de débrancher les câbles de communication, vous devez marquer leurs numéros afin d'éviter toute séquence incorrecte.

5.2.3 Replacement of 3rd level Control Module (MBMS)

5.2.3.1 Turn off the Power Switch. Refer to chapter 3.6.5.



Caution: Turn off this MBMS will stop the power output of belonging whole Battery Energy Storage System.

La désactivation de ce MBMS arrêtera la sortie de puissance du système de stockage d'énergie de batterie.

5.2.3.2 Dismantle the 4 screws.

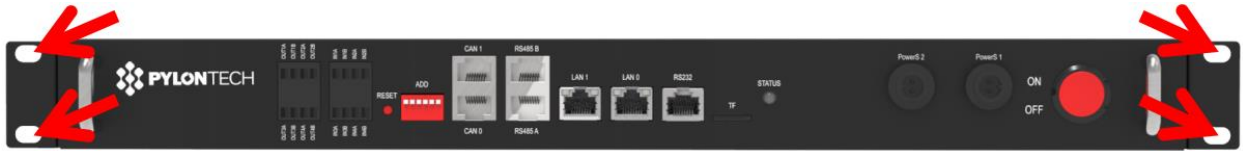

5.2.3.3 Install the new MBMS inside. And reconnect the cables. Refer to chapter 3.5.

5.2.3.4 Turn on this MBMS. Refer to chapter 3.6.



Caution: Before pull out the communication cables must mark the cable number, to avoid cable wrong sequence.

Avant de débrancher les câbles de communication, vous devez marquer leurs numéros afin d'éviter toute séquence incorrecte.

5.3 Battery Maintenance



Danger: The maintenance of battery must done by qualified and authorized person only.

La maintenance de la batterie doit être effectuée uniquement par le personnel qualifié et autorisé.

Danger: Some maintenance items must shut off at first.

Certains items de maintenance doivent être arrêtés en premier.

5.3.1 Voltage Inspection:

[Periodical Maintenance] Check the voltage of battery system through the monitor system. Check the system abnormal voltage or not. For example: Single cell's voltage is abnormal high or low.

5.3.2 SOC Inspection:

[Periodical Maintenance] Check the SOC of battery system through the monitor system. Check the battery string abnormal SOC or not.

5.3.3 Cables Inspection:

[Periodical Maintenance] Visual inspect all the cables of battery system. Check the cables has broken, aging, getting loose or not.

5.3.4 Balancing:

[Periodical Maintenance] The battery strings will become unbalance if long time not be full charged. Proposal: every 3 month should do the balancing maintenance (charge to full).

5.3.5 Output Relay Inspection:

[Periodical Maintenance] Under low load condition (low current), control the output relay OFF and ON to hear the relay has click voice, that's mean this relay can off and on normally.

5.3.6 History Inspection:

[Periodical Maintenance] Analysis the history record to check has accident (alarm and protection) or not, and analysis its reason.

5.3.7 Shutdown and Maintenance:

[Periodical Maintenance] Some battery function must be restart the ESS then can do the maintenance. So it must minimal 6 months do once.

5.3.8 Recycle

NOTE

Damaged batteries may leak electrolyte or produce flammable gas.

In case a damaged battery needs recycling, it shall follow the local recycling regulation (ie. Regulation (EC) N° 1013/2006 among European Union) to process, and using the best available techniques to achieve a relevant recycling efficiency.

5. Remarks

Storage

For long-term storage, if stored for a long time (more than 3 months), the battery cells should be stored in the temperature range for 5~45°C, relative humidity <65% and contains no corrosive gas environment.

The battery should shelved in 5~45°C, dry, clean and well ventilated environment. Before storage the battery should be charged to 50~55% SoC;

It is recommended to discharge and charge the battery every 3 months, and the longest discharge and charge interval shall not exceed 6 months.



Caution: If not follow the above instructions for long term store the battery, The cycle life will have relative heavily reduction.

Si vous ne suivez pas les instructions ci-dessus pour stocker la batterie à long terme, cela réduira son cycle de vie.

Capacity expansion

A new battery module can be add onto an existing system at any time. Please make sure the existing system is being fully charged before add on a new module. In a serial connection system, the new module, even has a higher SOH, will follow the system worst SOH condition module to perform.

6. Shipment

For single battery cell will as 55%SOC or according to customer requirement before shipment. The remaining capacity of battery cell, after shipment and before charge, is determined by the storage time and condition.

1. The battery modules meet the UN38.3 certificate standard.
2. In particular, special rules for the carriage of goods on the road and the current dangerous goods law, specifically ADR (European Convention on the International Carriage of Dangerous Goods by Road), as amended, must be observed.

Annex 1: Cable connection diagram (CAN ≤ 6 set)

12V DC Power Cable of AC/DC Adaptor to AC output socket of the UPS

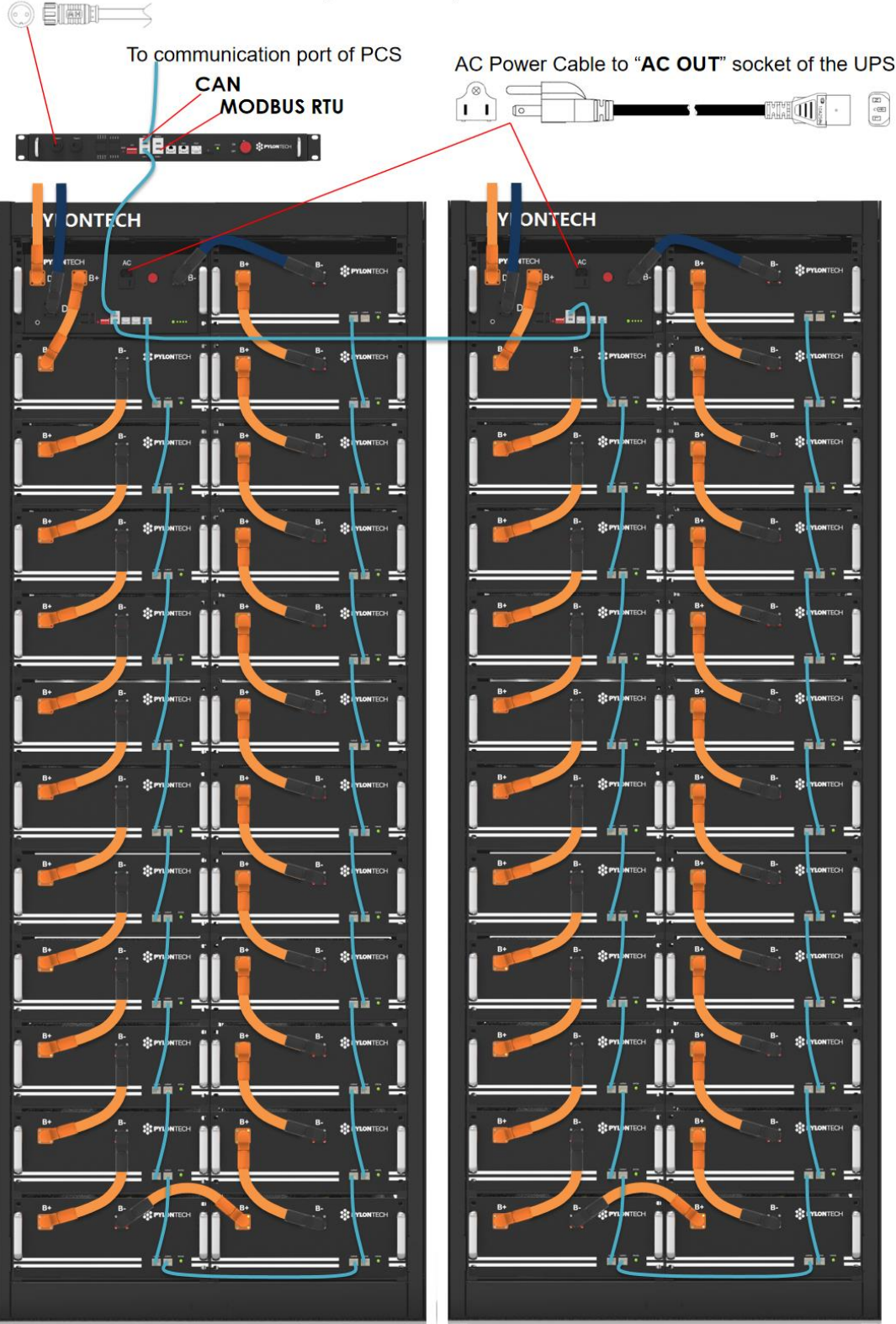

Annex 2: Cable connection diagram (Ethernet)

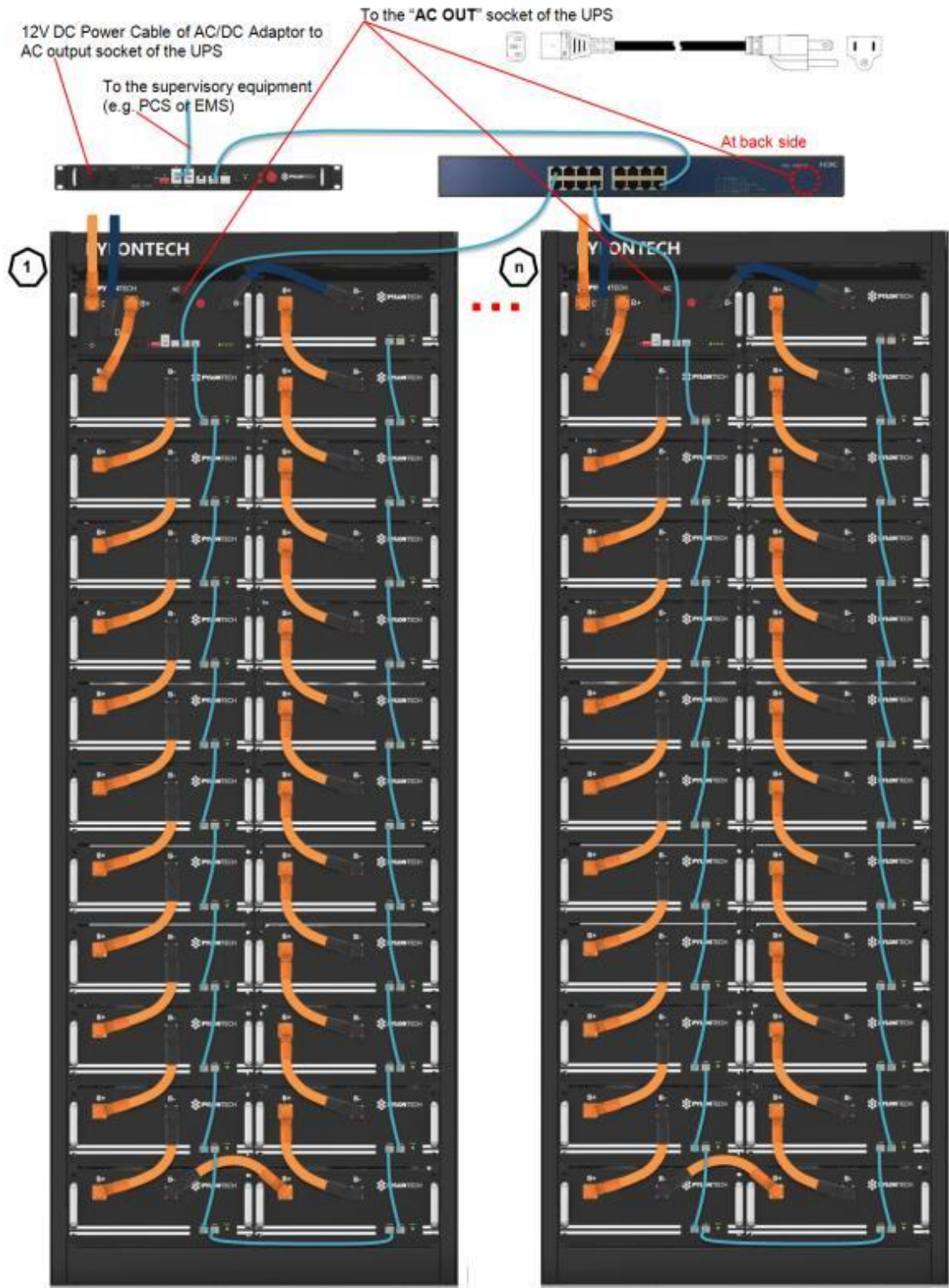

Annex 3: Installation and System Turn ON Progress List

| Tick after completion | No. | Item | Remark |
|--------------------------|-----|---|--|
| <input type="checkbox"/> | 1 | The environment is meeting all technical requirements. 3.3.1 Cleaning 3.3.2 Temperature 3.3.3 Radiating System 3.3.4 Heating System 3.3.5 Fire-extinguisher System 3.3.6 Grounding System | Refer to chapter 3.3 |
| <input type="checkbox"/> | 2 | Battery rack is installed follow the technical requirements. | Refer to chapter 3.5.3. |
| <input type="checkbox"/> | 3 | Control Module (BMS) and Battery Module are installed well. And install the rack metal strip. | Refer to chapter 3.5.4. |
| <input type="checkbox"/> | 4 | The MBMS are installed well. (If configured.) | Refer to chapter 3.5.5. |
| <input type="checkbox"/> | 5 | The Ethernet Switch is installed well. (If configured.) | Refer to chapter 3.5.6. |
| <input type="checkbox"/> | 6 | Connect the AC power cables from BMS, MBMS and Ethernet Switch to the AC "OUT PUT" socket of the UPS. (If configured.) | Refer to chapter 3.6.2.1 or 3.6.2.2. |
| <input type="checkbox"/> | 7 | Connect External Power Cable +/- between each BMS to the PCS or confluence cabinet. | Refer to chapter 3.6.2.1 or 3.6.2.2. |
| <input type="checkbox"/> | 8 | Connect power cables of each battery string. | Refer to chapter 3.6.2.1 or 3.6.2.2. |
| <input type="checkbox"/> | 9 | Connect communication cables of each battery string. | Refer to chapter 3.6.2.1 or 3.6.2.2. |
| <input type="checkbox"/> | 10 | Set up ADD switch of every BMS and the MBMS (Address Assignment). | Refer to chapter 3.6.3. |
| <input type="checkbox"/> | 11 | Connect external communication cables from BMS to Ethernet Switch, MBMS or another | Refer to chapter 3.6.2.1 or 3.6.2.2. |
| <input type="checkbox"/> | 13 | Connect the communication cable from MBMS to the PCS. | Refer to chapter 3.6.2.1 or 3.6.2.2. |
| <input type="checkbox"/> | 14 | Double check every power cables, communication cables installed well. And ADD Switches are setting right. | Refer to chapter 3.6.2.1 or 3.6.2.2 and 3.6.3. |

| | | | |
|--------------------------|----|--|--|
| <input type="checkbox"/> | 15 | Check the UPS is turned on. And the UPS is power supplying. | Refer to chapter 3.6.4. |
| <input type="checkbox"/> | 16 | Switch the external power or PCS on, to sure all the power equipments can work normally. | Refer to chapter 3.6.4. |
| <input type="checkbox"/> | 17 | <p>Turn the BMS (Battery Control Modules) of each battery string on (from 1st BMS to the last, one by one)</p> <ul style="list-style-type: none"> ● Turn on the "POWER OUTPUT SWITCH": ● Turn on the "Power Switch": ● The battery string's system will check itself, if work normal the battery string system will goes into self-check mode. <p style="padding-left: 40px;">If has failure during the self-check, must debug the failure then can start next step.</p> | Refer to chapter 3.6.4. |
| <input type="checkbox"/> | 18 | <p>If every battery string are working normally.</p> <p>Then switch the MBMS on. The MBMS will self-check and check each battery string one by one.</p> | Refer to chapter 3.6.4. |
| <input type="checkbox"/> | 19 | <p>The first installation should do full charging progress.</p> <p>After MBMS has communicated with each BMS, it will run parallel operation. It will begin from lowest voltage battery string to do the parallel operation during the charging.</p> <p>If the status LED of BMS turns to green, it means this battery string is in parallel operation.</p> | The first installation should do full charging progress. |

Annex 4: System Turn OFF Progress List

| Tick after completion | No. | Item | Remark |
|--------------------------|-----|---|-------------------------|
| <input type="checkbox"/> | 1 | Turn off the switch between PCS and this battery string (PowerCube-M1-C), or turn off the power switch of PCS, to make sure no current through this battery string. | Refer to chapter 3.6.5. |
| <input type="checkbox"/> | 2 | Turn off the "Power Output Switch" of the BMS. | Refer to chapter 3.6.5. |
| <input type="checkbox"/> | 3 | Turn off the "Power Switch" of the BMS. | Refer to chapter 3.6.5. |
| <input type="checkbox"/> | 4 | Turn off the "Power Switch" of the MBMS. | Refer to chapter 3.6.5. |
| <input type="checkbox"/> | 5 | Turn off the UPS. <ul style="list-style-type: none"> ● The UPS can turn on to check the equipment (PCS or battery system etc.). Otherwise must turn off the UPS to save its power. | Refer to chapter 3.6.5. |



PYLONTECH

Pylon Technologies Co., Ltd.

No. 73, Lane 887, ZuChongzhi Road, Zhangjiang Hi-Tech Park

Pudong, Shanghai 201203, China

T+86-21-51317699 | **F** +86-21-51317698

E service@pylontech.com.cn

W www.pylontech.com.cn