



ATESS BYPASS100/250/500/630/1000 User Manual

Shenzhen Ateess Power Technology Co.,Ltd

GROWATT-ATESS Industrial Park, No.23 Zhulongtian Road, Shuitian Community,
Shiyan Street, Baoan District, Shenzhen

T + 86 755 2998 8492

E info@atesspower.com

W www.atesspower.com

Contents

1 About this Manual

- 1.1 Contents
- 1.2 Target readers
- 1.3 How to use this manual

2 Safety instructions

- 2.1 Symbols explanation
- 2.2 Notice for use
- 2.3 Installation
- 2.4 Operation personnel
- 2.5 Important note

3 Product Description

- 3.1 BYPASS
- 3.2 Circuit diagram of BYPASS
- 3.3 Layout of the main components
- 3.4 Product information

4 Transportation and storage

- 4.1 Transportation
- 4.2 Inspection and storage

5 Products installation

- 5.1 Installation condition and requirements
- 5.2 Tools and spare parts required for whole machine installation
- 5.3 Mechanical installation
- 5.4 Electrical installation
- 5.5 Communication
- 5.6 System wiring

6 Pilot operation

- 6.1 Inspection
- 6.2 Commissioning

7 Routine maintenance

- 7.1 Regular maintenance
- 7.2 Waste disposal

8 Appendix

- 8.1 Specification
- 8.2 ATESS Factory warranty

1 About this Manual

This chapter describes the contents of this manual, target reader, and safety symbols, can help users to have a better understanding of the manual.

1.1 Contents

This manual applies to ATESS BYPASS , it contains:

> Safety instruction

Attention that needs to be paid when operating and maintaining ATESS BYPASS model.

> Product description

Function, structure, principle and package information of the ATESS BYPASS model.

> Transportation and storage

The mode of transportation of the product and the related storage precautions notice.

> Installation

Bypass installation conditions, tools, mechanical and electrical installation, the communication connection etc..

> Commissioning

Inspection before commissioning.

> Routine maintenance

Daily maintenance of BYPASS, the replacement of some spare parts and waste disposal instruction.

> Appendix

Technical data, warranty policy and contact information etc..

1.2 Target readers

Qualification:

- > Only professional electricians or professionally qualified personnel can transport or install this product.
- > The operator should be fully familiar with the structure and working principle of the entire BYPASS;
- > The operator should be fully familiar with this manual;
- > The operator should be fully familiar with the local standards of the project.

1.3. How to use this Manual

Read this manual before installation of the ATESS BYPASS. Store this manual where accessible at all times.







The contents of this manual will be periodically updated or revised if necessary.

2 Safety instructions

2.1 Symbols explanation

In order to ensure the personal and property safety of the user during installation, or optimally efficient use of this product, symbols are used highlight the information.

The following symbols may be used in this manual, please read carefully, in order to make better use of this manual.

	DANGER DANGER indicates a hazard with a high level of risk which, if not avoided, will result in death or serious injury.
	CAUTION CAUTION indicates there is potential risk, if not avoided, could result in equipment malfunction and property damage.
	Caution, risk of electric shock When battery bank connecting point are exposed, there will be DC voltage in the equipment DC side; and when output breaker is on, there is a potential risk of electric shock.
	Caution, risk of fire hazard Suitable for mounting on concrete or other non-combustible surface only.
	Protective conductor terminal BYPASS has to be firmly grounded to ensure the safety of personnel.
	Risk of electric shock, Energy storage timed discharge Electrical shock danger exists in the capacitor; the cover shall be moved at least 5 minutes later after all powers are disconnected.

2.2 Safety instructions

Bypass installation and service personnel must be trained and familiar with the general safety requirement when working on electrical equipment. Installation and service personnel should also be familiar with the local laws and regulations and safety requirements.

- Read this manual carefully before operation. The equipment will not be under warranty if failing to operate according to this manual.
- Operation on BYPASS must be for qualified electrical technician only.
- All electrical operation must comply with local electrical operation standards.

2.3 Installation

Proper installation requires following all the instructions in the user manual involving transportation, mounting, wiring and commissioning. ATESS does not cover warranty for BYPASS damage due to failing to use it properly.

The protection level of BYPASS is IP20, which is designed for indoor installation. Please refer to chapter 5 for installation instruction.

Other notice for using BYPASS:

- Pay attention to the safety instructions listed here and below;
- Pay attention to the user manual of energy storage controller;
- Technical data related to equipment shall be considered.

2.4 Operator

Bypass installation and service personnel must be trained and familiar with the general safety requirement when working on electrical equipment. Installation and service personnel should also be familiar with the local laws and regulations and safety requirements.

2.5 Important note



Item 1: Static electricity can cause damage to BYPASS electrostatic discharge may cause unrecoverable damage to BYPASS internal components!
When operating BYPASS, operator must comply with anti-static protection norms!

Item 2: Restriction
BYPASS cannot be directly used to connect the life support equipment and medical equipment!

Item 3: Precautions
Make sure installation tools or other unnecessary items are not left inside the BYPASS before starting up.

Item 4: Maintenance notice
Maintenance can only be carried out after BYPASS totally discharged.

3 Product description

3.1 BYPASS

ATESS BYPASS model is designed to work ATESS PCS500. Its main function is: 1. To make PCS realize off-grid fast switching, to ensure uninterrupted supply for load. 2. To allow PCS be able to connected to power grid and generator at the same time. 3. To allow the system be able to used with PV inverter(it needs to confirm with our engineer whether the inverter is compatible with ATESS PCS system).

3.2 Circuit diagram of BYPASS

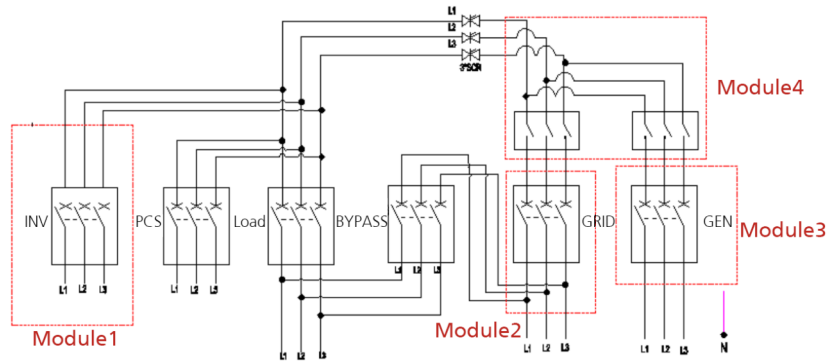

Module 1	PV input	This module can realize the access function of PV inverter, only the inverter produced by ATESS is recommended. Confirm with R & D in advance if other inverters are selected on whether the PV inverter can be connected.
Module 2	Grid input	The module is connected to realize the on/off grid switching function between PCS and grid.
Module 3	DG input	The module is connected to realize the on/off grid switching function between PCS and DG.
Module 4	To realize connection of DG or grid	This module is only needed when connecting DG and grid at the same time, the module won't be consisted if the system is connected to either one.

3.3 The layout of the main components

3.3.1 External components

The external components of BYPASS contain only indicators.

> Indicator

BYPASS adopts intelligent design. The current power status of it can be known through three indicator lights on the door panel. Only when the system is connected with DG and grid simultaneously are there three indicators.



LED	Description
PCS	The indicator lights up when there is power on the AC side of PCS and it can supply power to the load normally
Grid	The indicator lights up when there is power on grid side
GEN	The indicator lights up when there is power on DG side

3.3.2 internal component

The internal devices of BYPASS include PCS circuit breaker, PV circuit breaker, power grid circuit breaker, maintenance switch, DG circuit breaker, load circuit breaker, thyristor, power supply micro break and PCB board.

Note: BYPASS is a function cabinet customized according to customers' needs. There are different requirements and internal devices. The figure below shows the front layout of the BYPASS500 with full function (different models have different layouts).

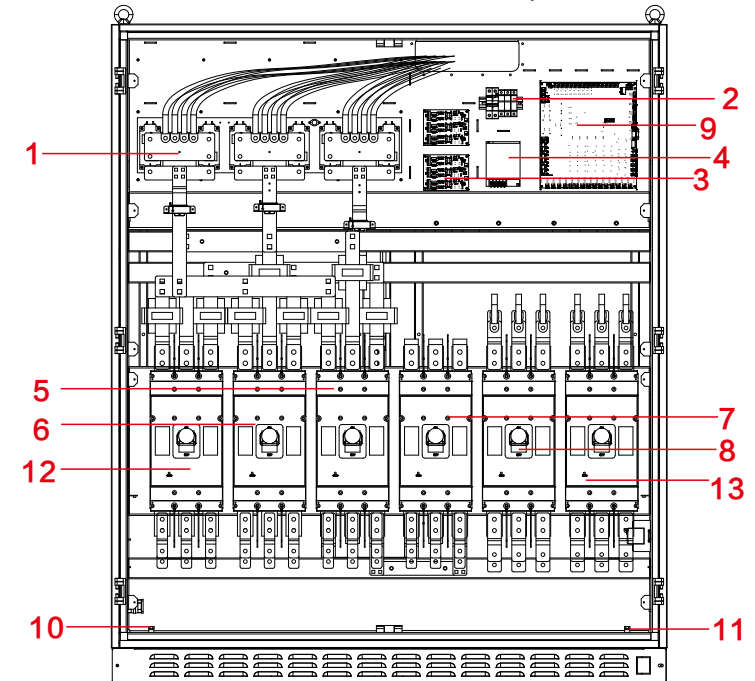

The front structure drawing of BYPASS

Transportation and storage 4

No.	Item name	Description
1	Thyristor	On/off grid switch
2	Power supply micro break	Control connection of control board power
3	Driving board	Drive circuit board of thyristor
4	Mingwei power supply	Supply power to control board
5	Load breaker	Control connection with load
6	PCS breaker	Control connection with PCS
7	Maintenance breaker	Maintenance switch
8	Grid breaker	Control connection with grid
9	Control board	Control logic of BYPASS and communication with PCS
10	N bar	Load, grid n-wire terminal
11	Ground bar	Machine grounding copper bar
12	Inverter breaker	Control connection with PV inverter
13	Ground breaker	Control connection with DG

3.4 Product information

3.4.1 Dimension and weight

Model	Dimension(W*D*H/mm)	Gross weight(KG)
BYPASS100	W700*D500*H1630	115
BYPASS250	W750*D500*H1800	165
BYPASS500	W1600*D800*H1900	905
BYPASS630	W1600*D800*H1900	955
BYPASS1000	W2555*D800*H2130	1100

Figure-- Dimension and weight of BYPASS

Note: the BYPASS cabinet is customized according to the needs of the project. The actual size and weight deviate from the above table. The actual accurate data can be provided by our sales department.

3.4.2. Packing information

NO	Name	Unit	Qty.	Note
1	BYPASS	unit	1	Key included
2	User manual	pcs	1	
3	Certificate	pcs	1	
4	Factory test report	pcs	1	

Figure-- Packing information

4.1 Transportation

Transportation should follow the transportation methods described in the user manual. BYPASS's weight and center of gravity should be taken into account during transportation. The center of gravity is marked on the box.



Caution, risk of danger

During transportation, lifting equipment and personnel must be qualified. Bypass should be placed vertically and the inclination cannot be more than 10 degrees. It is not allowed to place BYPASS upside down or transport in a horizontal position. Incorrect lifting and transportation can lead to serious injury, property loss and damage to BYPASS.

4.2 Inspection and storage

Bypass should be carefully checked before signing the document from the transportation company. Check the received items against delivery note, and if there is any defect or damage, immediately notify the transportation company. If necessary, you can seek help from ATESS Customer Service department.



Caution

ATESS BYPASS50 can only be stored when it is stopped and all the doors are closed in a dry room to protect the internal circuits against dust and moisture.

5 Installation

5.1 Installation condition requirements

To ensure normal operation of the machine, the installation environment is required as follows:

- > The ingress protection of BYPASS is IP20. Moreover, as this product is an electrical equipment, it shall not be placed in humid environment;
- > Install indoors and avoid sunlight and rain;
- > Ventilation of the room shall be good;
- > The installation environment shall be clean;
- > As some noise will be produced in operation, this equipment shall be installed far from residential quarters;
- > The installation ground shall be even enough, and firm enough to support the weight of BYPASS;
- > The installation position shall be convenient for maintenance;
- > Ambient temperature range: $-25^{\circ}\text{C} \sim 55^{\circ}\text{C}$;
- > Appropriate space shall be reserved for the machine to ensure ventilation and cooling.

We suggest BYPASS is installed in the distribution room. The floor, wall clearance, Ventilation equipment and precaution should be designed by professional personnel and satisfy the following requirements.

> Foundation requirement

Bypass is required to install on even ground with fire-retardant material as the surface or channel steel support structure, and sag or tilt ground is prohibited. The foundation shall be solid, safe and reliable. The foundation shall be capable of bearing the load of BYPASS. Its load bearing ability shall be concerned throughout the installation place selection.

> Clearance space

During installation of BYPASS, appropriate space shall be left to the wall or other equipment, in order to satisfy the requirements on narrowest maintenance channel, emergency access and ventilation.

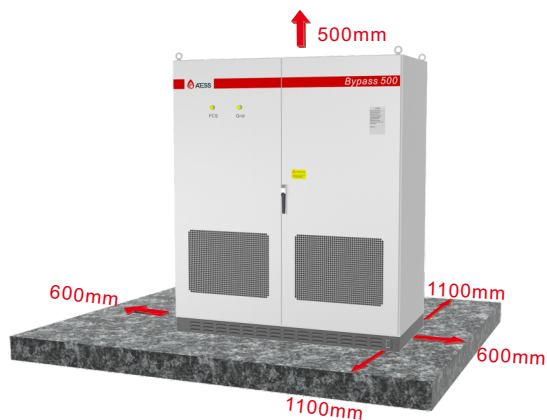

In front of the installation place of BYPASS, a space of 1.5m or more shall be ensured, the back 0.6m or more, the top 0.6m or more to ensure easy installation, cooling and maintenance.

> Cable trench

The cable connection of BYPASS adopts bottom inlet and bottom outlet. Cable trenches are recommended to ensure easy installation and maintenance.

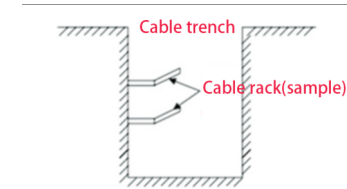

The cable trenches are often designed and constructed by the construction side based on relevant standards, with the equipment weight and dimensions required to be considered. Good electrical connection is needed between different cable trenches and GND terminals.

> Wiring specification

Cables in BYPASS can be classified into either power cables or data cables. In cabling, the power cable shall be kept far away from, and the cable shall be kept in right angle at cross. The cable shall be as short as possible, and an appropriate distance shall be kept to the power cable.

The power cable and data access shall be placed in different cable trenches respectively to avoid lengthy routing between the power cable and other cables, so as to reduce the electromagnetic interruption caused by sudden change of the output voltage. The distance among the power cable and data access shall be more than 0.2m. When the cables are crossed, the cross angle shall be 90 degrees, while the distance can be reduced appropriately.

> Ventilation requirement

In operation, BYPASS will produce heat. When ambient temperature is too high, the electrical property of the equipment may be affected, the equipment may even be damaged. Therefore, the heat release shall be fully considered in designing the control room to ensure operation of the equipment in high efficiency. In front of the installation place of BYPASS, a space of 1.5m or more shall be ensured, the back 0.6m or more, the top 0.6m or more to ensure easy installation, cooling and maintenance.

> Ventilation environment

To satisfy the ventilation requirement of BYPASS, its installation environment shall meet the following conditions:

- ※ BYPASS shall be prevented from being installed in the place of poor ventilation condition and insufficient air flow;
- ※ The air inlet shall have enough air supplementation.

> Ventilation equipment

To ensure safe and reliable operation of the equipment, the ambient temperature must be within the permission range $-25^{\circ}\text{C} \sim 55^{\circ}\text{C}$, therefore, appropriate ventilation devices must be equipped with to release the heat generated by the equipment. We suggest the ventilation rate is more than $3665\text{m}^3/\text{h}$.

1. There must be ventilation equipment inside the distribution room to ensure release of the waste heat generated by BYPASS from the equipment, and allow for maximum ambient environment temperature. This can be realized from installation of exhaust devices;
2. Another fan can be added at the air duct outlet to exhaust the air out and ensure balanced pressure;
3. The direction of the air outlet shall be selected according to the local actual wind direction;
4. Pay attention to the dustproof measures and waterproof design at the air inlet and outlet;
5. If more air ducts are required, its dimensions shall be designed by the professionals according to the air output amount.

> Other protections

With IP20 of protection level, BYPASS is appropriate to be installed in dry and clean environment. Meanwhile, water leakage of the house shall be prevented, as it may damage BYPASS. According to EMC requirement and noise level, BYPASS shall be installed in industrial environment.

5.2 Tools and spare parts required for whole machine installation

Tools and spare parts required for installation is as follows:

- > Hoisting crane, forklift or fork lift truck (with the capacity for bearing the weight of the BYPASS)
- > Torque wrench
- > Screwdriver
- > Wire stripper
- > Terminal crimping machine
- > Heat dryer
- > Megger and multimeter

5.3 Mechanical installation

5.3.1 Transportation of packaged whole machine

This BYPASS is transported as an integrated unit, and the user can hoist it from the bottom with a forklift, or move it with a hoisting crane or crane.

Note 1: BYPASS is integrated and cannot be dissembled either in transportation or installation. Any fault attributed to modification unauthorized by the ATESS is beyond the quality assurance.

Note 2: In movement, tilt, violent shake or sudden force upon BYPASS shall be prevented, such as sudden down of lifting.

Note 3: Please read carefully the labeled parameters to select an appropriate transportation means and storage place.

We suggest the user make use of forklift to move BYPASS if possible.



Before BYPASS is moved to the designated place, we suggest to lay the DC input cable and AC main power supply cable. As these cables are relatively thick, they are hard to be cabled after BYPASS is installed.

To keep the equipment in a better protective status, please adopt transportation with package as much as possible, and comply with the labels printed on the package in transportation:

Sign	Indication
	The gravity centre
	Lifting logo
	Face up to prohibit BYPASS horizontally, tilted or upside down
	Handle with care, to avoid the transport environment too intense collision friction damage to BYPASS
	Keep away from moisture

Bypass whose packages are not demolished can be moved with forklift, hoisting crane or crane. In moving, attention shall be paid to the weight painted on the package to ensure enough load capacity of the devices. As the gravity center of the equipment locates at the lower place symmetrical in front and back and left and right, the support point or hoisting point shall be arranged reasonably in transportation.

The forklift transportation is the standard one. The gravity center of the cabinet in transportation should locate between two forks of the forklift. The big-size BYPASS may block driver's sight, and it shall be treated with cooperation of the aid personnel.

5.3.2 Movement and installation of bare machine

> Demolish the package of BYPASS

Please demolish the packaged cabinet of the equipment according to the following procedures:

Procedure 1: Demolish the wood side and roof of the packaged cabinet

Procedure 2: Demolish the out-set package material on the machine

Procedure 3: Demolish the fastening screws between the machine and the pallet

- ① Demolish the front and back cover lids of the pedestal;
- ② Screw off the hold-down nuts at the bottom of the wood pallet;
- ③ Remove the screws, and BYPASS will depart from the wood pallet.

> Movement and installation of bear machine

BYPASS with demolished package can be moved with forklift, hoisting crane, slide rail or crane. If the package demolished place is far from the final installation place, it can be transported with forklift containing wood pallet.

If the wooden pallet at the bottom of the machine has been removed, when using the forklift, the front and rear cover plates of the base need to be removed first, and the center of gravity should be placed in the middle of the two forklifts, and then start lifting and transporting, as shown in the following figure:

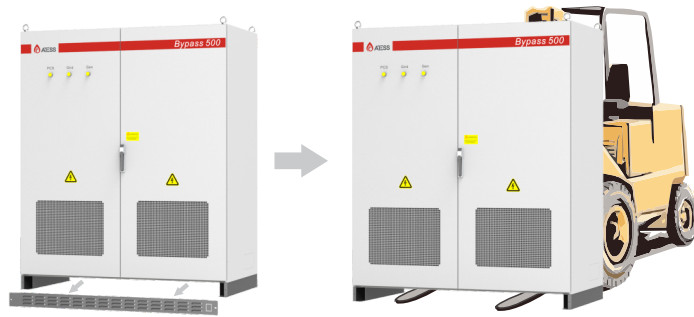

Caution, risk of danger

We must act slowly and gently when transporting BYPASS with forklift to avoid violent vibration of BYPASS or collision with other objects.

If lifting method is used for moving, please pay attention to the lifting position, ensure that the lifting angle is 70°, and be cautious of the center of gravity position of BYPASS.

NOTE:

- It is necessary to always pay attention to the position of the center of gravity of BYPASS.
- Take necessary auxiliary measures to ensure the safety of transportation personnel;
- Take necessary auxiliary measures to ensure that the equipment is delivered to the final installation site.

5.4 Electrical installation

5.4.1 Input and output requirements



Caution, risk of danger

- There is a danger of electrical shock of high voltage in BYPASS' operation; only electricians of professional skills can operate.
- All connections with this equipment shall be done under non-voltage state.
- BYPASS may be damaged if input or output terminal is incorrectly plugged.

Failure of acting upon this information may cause serious personnel injury or significant property loss even to death.

➤ **Load**

The total power of load input shall be within the capacity of BYPASS.

➤ **Three phase grid connection**

Grid required to be connected with the system is three phase grid, and should be in accordance to the previous agreed grid level. Otherwise, damage to the machine due to voltage level problems is not in the scope of warranty.

➤ **Cable requirements**

1. Please select the corresponding withstand voltage cable according to the voltage level.
2. The current will change due to different voltage value. Please calculate the corresponding cable diameter according to the actual voltage range. The following table only provides cable requirements for the minimum operating voltage for your reference.

	BYPASS100		BYPASS250		BYPASS500	
	Diameter(mm ²)	Aperture	Diameter(mm ²)	Aperture	Diameter(mm ²)	Aperture
PV input	At least a 75mm ² line each phase	Φ8	At least two 75mm ² line each phase	Φ8	At least three 95mm ² line each phase	Φ 10
PCS input	At least a 75mm ² line each phase	Φ8	At least two 75mm ² line each phase	Φ8	At least three 95mm ² line each phase	Φ 10
Load input	At least a 75mm ² line each phase	Φ8	At least two 75mm ² line each phase	Φ8	At least three 95mm ² line each phase	Φ 10
Grid input	At least a 75mm ² line each phase	Φ8	At least two 75mm ² line each phase	Φ8	At least three 95mm ² line each phase	Φ 10
DG input	At least a 75mm ² line each phase	Φ8	At least two 75mm ² line each phase	Φ8	At least three 95mm ² line each phase	Φ 10
N line	At least a 75mm ² line each phase	Φ8	At least two 75mm ² line each phase	Φ8	At least three 95mm ² line each phase	Φ 10
PE line	At least 25mm ² line(special yellow green line)	Φ8	At least 35mm ² line(special yellow green line)	Φ8	At least 75mm ² line(special yellow green line)	Φ8
Comm line	0.75mm ² special twisted pair shielded comm. line		0.75mm ² special twisted pair shielded comm. line		0.75mm ² special twisted pair shielded comm. line	

	BYPASS630		BYPASS1MW	
	Diameter(mm ²)	Aperture	Diameter(mm ²)	Aperture
PV input	At least four 95mm ² line each phase	Φ 10	At least five 120mm ² line each phase	Φ 10
PCS input	At least four 95mm ² line each phase	Φ 10	At least five 120mm ² line each phase	Φ 10
Load input	At least four 95mm ² line each phase	Φ 10	At least five 120mm ² line each phase	Φ 10
Grid input	At least four 95mm ² line each phase	Φ 10	At least five 120mm ² line each phase	Φ 10
DG input	At least four 95mm ² line each phase	Φ 10	At least five 120mm ² line each phase	Φ 10
N line	At least four 95mm ² line each phase	Φ 10	At least five 120mm ² line each phase	Φ 10
PE line	At least 75mm ² line(special yellow green line)	Φ 8	At least 95mm ² line(special yellow green line)	Φ 8
Comm. line	0.75mm ² special twisted pair shielded comm. line		0.75mm ² special twisted pair shielded comm. line	

The corresponding port to access shall be selected according to the customized function and model, the accessing port is different with different requirements.

5.4.2 Grid side wiring



Caution, risk of danger

When connecting the AC grid, cut off the circuit breaker at the AC side to ensure that the AC wire connecting to terminals has no electricity.

The output voltage of the AC side of BYPASS is 400V, the wiring method of AC side and grid side is as follows:

- 1) Cut off the circuit breaker at grid side, to ensure that the AC wire connecting to terminals has no electricity. Confirm it with a multimeter.
- 2) Ensure that the wiring phase sequence at AC side is consistent with the phase sequence at grid side.
- 3) Strip the insulation skin off at the end of the cable
- 4) Crimping copper nose
 1. Put the exposed copper core of the stripped wire head into the crimping hole of the copper nose.
 2. Use the terminal crimper to compress the copper nose of the wiring, and the number of crimping shall be more than two.
- 5) Install the shrink fit sleeve.
 1. Select the heat shrinkable sleeve which is more consistent with the cable size, length is about 5cm.
 2. The heat shrinkable sleeve shall be sleeved on the copper nose of the wiring to completely cover the wire pressing hole of the copper nose.
 3. Use a heat blower to tighten the heat shrink sleeve.

6) Connect "L1" cable to "L1" of AC distribution cabinet, i.e. phase a (U). Select the bolts that match the copper nose.

7) Connect "L2" of AC output to "L2" of AC distribution cabinet, i.e. phase B (V); connect "L3" of AC output to "L3" of AC distribution cabinet, i.e. phase C (W); connect n-line to n wire on BYPASS.

Note:

1. If the photovoltaic access function is selected, the connection steps are the same as those of grid connection steps 1 to 5. Then confirm the photovoltaic output phase sequence and connect it to the photovoltaic access port in turn.
2. If the access function of the oil turbine is selected, the connection steps are the same as those of the grid connection steps 1 to 5, then confirm the output phase sequence of the oil turbine, connect it to the access port of the oil turbine in turn, and connect the n-line to the N-BAR.
3. Load access, the access steps are the same as those of grid access steps 1 to 5, then confirm the phase sequence, connect to the load access port in turn, and connect the load n line to the n-bank.

5.4.3 Earthing

BYPASS must be earthing well for safety; Please make sure of the connection between PE in power distribution cabinet and PE copper in BYPASS good; and make sure the earthing cable more than half of load cable, and earthing resistance is not lower than 4Ω.

All wiring into the channel at the bottom of BYPASS to be all the wiring is completed, the connection port must be sealed with dust cotton, to prevent dust from entering the inside of BYPASS.



Connect several connecting wires on the PE copper bar as some parts inside the energy storage controller need to be grounded, please do not change them without permission, so as to avoid electric shock

5.5 Communication

BYPASS communicates with PCS via CAN. The following figure is the schematic diagram of the control board interface.

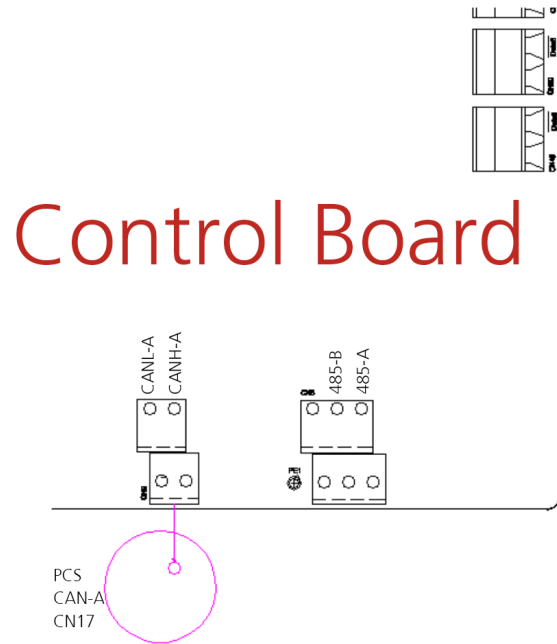

Schematic diagram of the control board interface

5.6 System wiring

BYPASS is a customized model, platform construction differs due to project requirements. In order to avoid misleading customers to build the system, we do not give detailed instructions in the manual. The specific drawings shall be provided separately, or the system drawings shall be obtained from the sales or after-sales personnel of ATESS when the project needs to build a system.

Note: all circuit breakers in BYPASS are with silk screen printing. When connecting to power grid, load, DG etc., they must be connected correspondingly in the right position and the right three-phase phase sequence. Otherwise, the system will not operate normally or even damage the machine.

Commissioning 6

6.1 Inspection before operation

Before BYPASS is put into operation, its installation shall be inspected. At least two staff do the inspection according to the items listed below to ensure the correctness of the installation.

Inspection items for installation

- There is no deformation or damage to BYPASS.
- Bottom of BYPASS is fixed securely, the foundation support is stable and reliable.
- There is enough space around BYPASS.
- The temperature, humidity and ventilation conditions of the environment where BYPASS is located meet the requirements.
- There is enough cooling air for ventilation.
- Cabinet sealing protection is complete and reliable

Electrical inspection

- Bypass is grounded completely and firmly.
- The grid voltage matches the rated output voltage of BYPASS.
- The phase sequence of grid connection is correct, and the tightening torque meets the requirements.
- Cable number is marked correctly and clearly.
- The insulation protection cover is complete and reliable, and the danger warning label is clear and firm.

Other inspection

- All useless conductive parts shall be tied with insulating ties.
- There are no tools, parts, conductive dust or other foreign matters left inside the cabinet.
- There is no condensation of moisture or ice in the cabinet.

6.2 Power on steps

All circuit breakers inside BYPASS are closed except the bypass switch is on. The power of BYPASS control board is taken from PCS. After the battery circuit is closed, the control board is powered on.

7 Routine maintenance

7.1 Regular maintenance

7.1.1 Maintenance and repair



CAUTION!

All maintenance and repair operations on the BYPASS can only be performed when the BYPASS is safely disconnected from all external connections, and it is confirmed that these power supplies will not be connected again and wait for at least 5 minutes.

Only professional technicians familiar with the system operation can perform such operation.

> **Disconnect the circuit breaker**

Disconnect all switches to ensure that BYPASS does not accidentally re-connect. Use a multimeter to test, make sure the device is disconnected and voltage free.

> **Maintenance and modification**

Only personnel authorized by ATESS can maintain and modify BYPASS. To ensure personal safety, please use only the original components provided by the manufacturer. Otherwise ATESS will not be held responsible for any problems in use.

> **How to use BYPASS switch**

If BYPASS fails and can not continue to operate, it needs to be shut down for maintenance. When the load connected to BYPASS needs to continue to work, the BYPASS switch can be used to power the load continuously by grid or generator, and the maintenance personnel can safely repair the machine.

Step 1: Turn on the PCS switch in case of machine failure.

Step 2: Except bypass switch, turn off all the switches on BYPASS.

At this time, the load is directly supplied by the grid, and PCS is not connected to the grid. However, if the PCS is to be overhauled, it must be carried out in accordance with the PCs maintenance manual. PCs still has DC input after power grid input is disconnected. Improper operation may cause electric shock.



CAUTION!

1. After power off, wait for 5 minutes to confirm safety before carrying out maintenance work.
2. Use multimeter to measure, ensure the safety before disassembling.

7.1.2 Replace the dust screen

During the use of BYPASS, the dust on the top shall be cleaned regularly, and the dust screen at the air inlet shall be cleaned or replaced. During the replacement of the dust screen, BYPASS shall be powered off.

Replacement method of dust screen: The dust-proof filter cotton on the door panel can be directly pulled up for cleaning and replacement.



In order to ensure the normal operation of BYPASS, it is necessary to clean the dust screen regularly.

7.1.3 Regular maintenance

In order to ensure the normal operation of BYPASS, regular maintenance work is required.

Recommended routine maintenance cycle and work, as shown in Table 7-2.

Maintenance item	Cycle
Clean SCR radiator	every month
Check the dust, moisture or condensation inside the cabinet	every month
Check the cable connections, and fix the screw if necessary	every month
Check the warning label, add or replace some if necessary	every month
Manual inspection on AC and DC circuit breakers	every month
Check if there is abnormal sound when BYPASS is operating	every week

Figure7-2 Routine maintenance work



CAUTION!

The maintenance operation of BYPASS must be carried out when all circuit breakers of BYPASS are disconnected. After the BYPASS circuit breaker is disconnected, some devices still have residual voltage. Please wait for at least five minutes to confirm safety before maintaining BYPASS to prevent electric shock.

7.2 Waste disposal

Bypass will not cause environmental pollution, since the all the components meet the requirements of environmental protection. According to environmental protection requirements, user shall dispose BYPASS in accordance with the relevant laws and regulations.

8 Appendix

8.1 Specification

Specification	BYPASS100	BYPASS250	BYPASS500	BYPASS630	BYPASS1MW
Rated voltage	400V	400V	400V	400V	400V
Rated current	144A	361A	722A	910A	1444A
Rated frequency	50HZ/60HZ	50HZ/60HZ	50HZ/60HZ	50HZ/60HZ	50HZ/60HZ
Rated power	100KW	250KW	500KW	630KW	1000KW
Maximum current	173A	433A	866A	1092A	1732A
Switch time	Auto≤10ms	Auto≤10ms	Auto≤10ms	Auto≤10ms	Auto≤10ms
Protection degree	IP20	IP20	IP20	IP20	IP20
Humidity	0%-95%	0%-95%	0%-95%	0%-95%	0%-95%
Ambient temperature	-25°C-55°C	-25°C-55°C	-25°C-55°C	-25°C-55°C	-25°C-55°C
Dimensions (W*D*H/mm)	700*500*1630	800*550*1980	1600*800*1900	1600*800*1900	3055*800*2130
Weight	115	165	905	955	1300
Comm. interface	CANA/485	CANA/485	CANA/485	CANA/485	CANA/485
PCS breaker	250A	630A	1250A	1250A	2000A
Bypass breaker	250A	630A	1250A	1250A	1600A
Bypass breaker	250A	630A	1250A	1250A	2000A
Load breaker	250A	630A	1250A	1250A	2000A
Grid breaker (optional)	250A	630A	1250A	1250A	2000A
DG breaker (optional)	250A	630A	1250A	1250A	2000A

8.2 ATESS Factory warranty

> Warranty period

The warranty period of this product is three years. If otherwise specified in the contract, the contract shall prevail.

During the warranty period, the customer shall show the invoice and date of purchase to the service personnel of ATESS. At the same time, the nameplate mark on the product shall be clear and visible, otherwise, ATESS has the right not to provide warranty service.

> Warranty conditions

In the event of failure during the warranty period, ATESS will repair or replace the product free of charge; The failed machine shall be owned by ATESS; the customer shall Set aside some time to repair the faulty machine.

> Liability exemption

In case of the following circumstances, ATESS has the right not to conduct warranty:

Products without logo of ATESS Power Technology logo;

The product or component that has exceeded the valid warranty period of ATESS;

Failure or damage (such as high temperature, low temperature, too wet or dry, high altitude, unstable voltage or current, etc.) caused by working in beyond-specified environment or wrong installation, storage or use that violates the instructions;

Failure or damage caused by unauthorized installation, repair, modification or disassembly;

Except for those authorized by the after-sales center of ATESS;

Failure or damage caused by using components that not supplied by ATESS;

Failure, damage or transportation damage caused by accident or human factors (operation error, scratching, carrying, bumping, improper voltage connection etc.);

Failure or damage caused by force majeure (such as earthquake, lightning, fire etc.);

Failures or damages caused by other factors rather than quality problems of the supplied product itself(including components).