

kóala

1.5 seater or chaise with arms

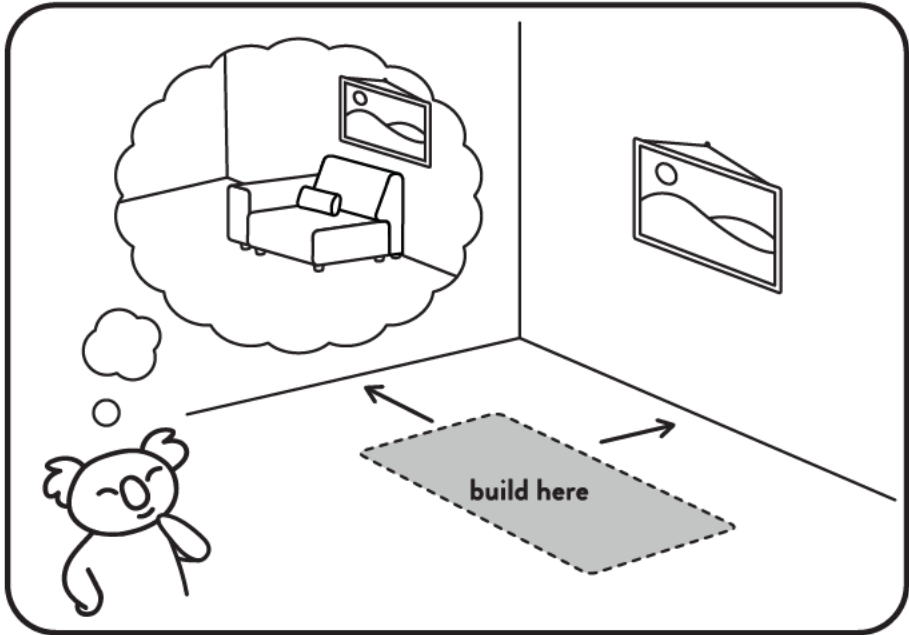

1.

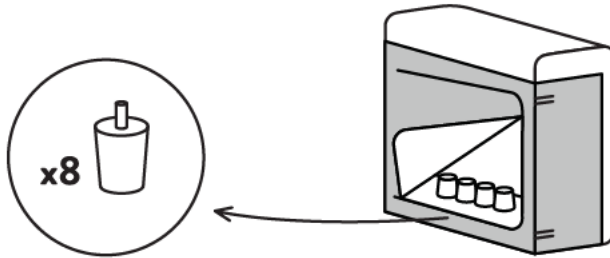

take all legs from inside zip pocket

2.

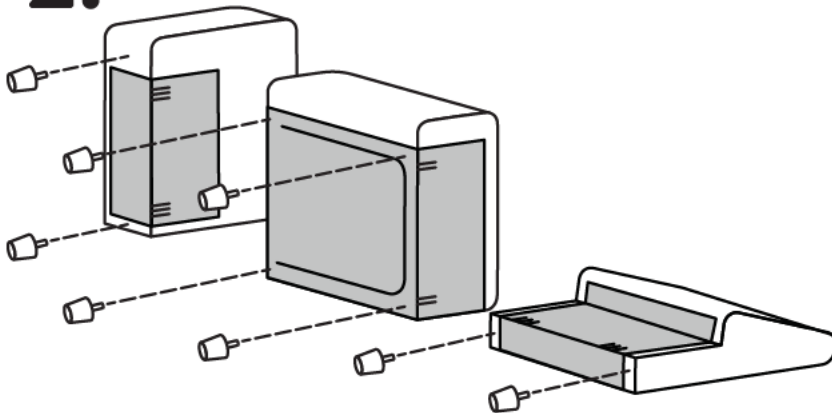

screw legs into all parts

3.

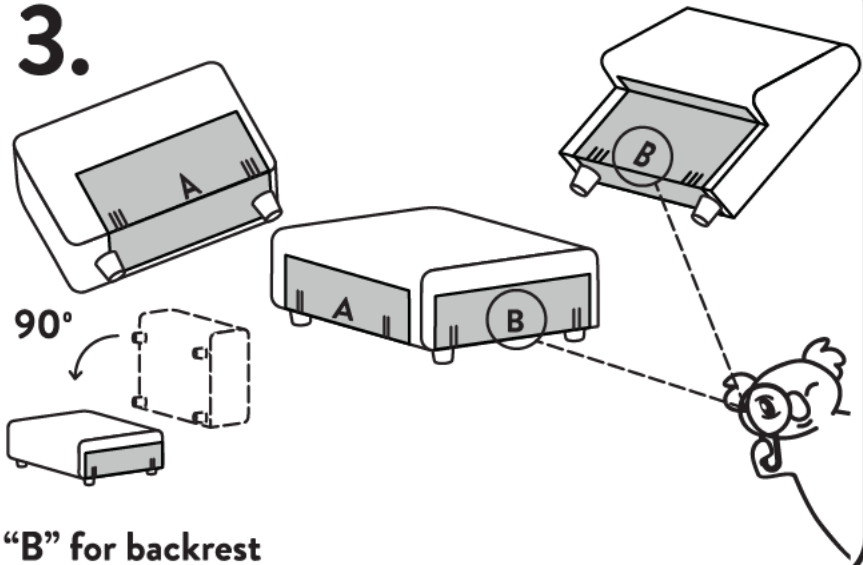

“B” for backrest

4.

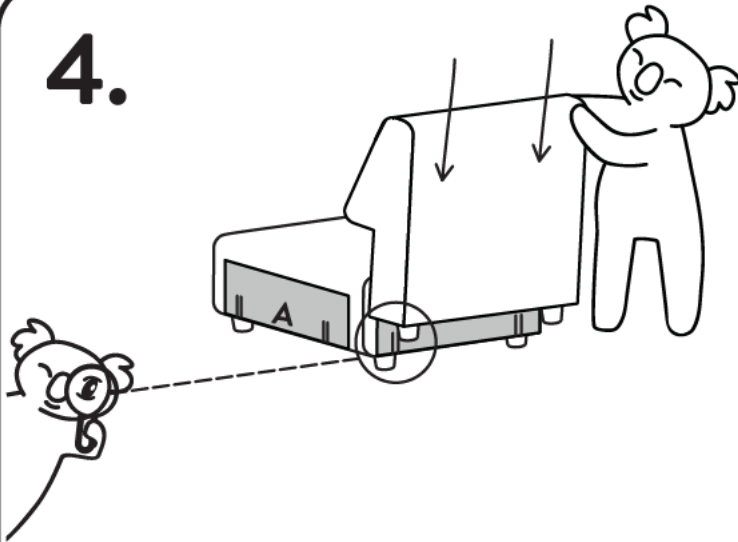

align connections and push down

5.

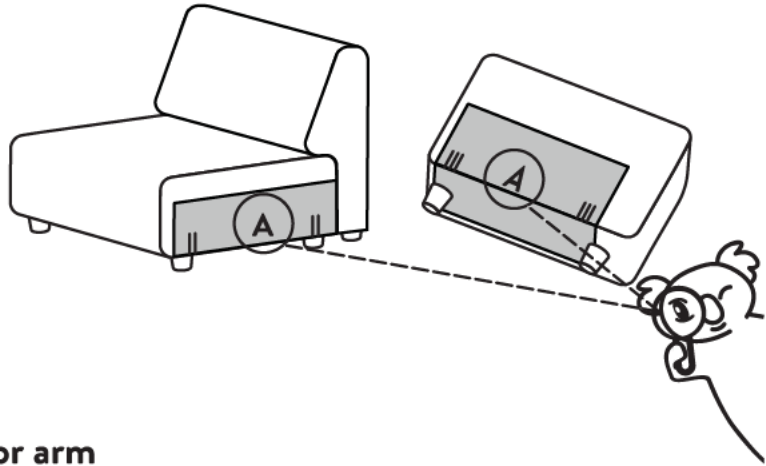

“A” for arm

6.

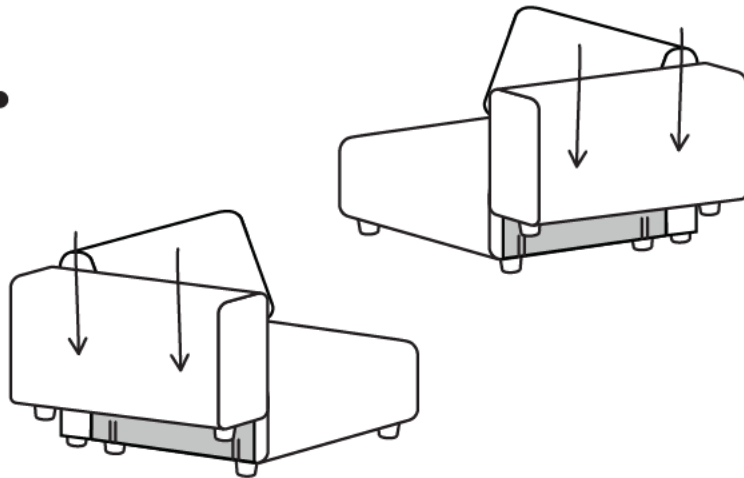

align connectors and push down

7

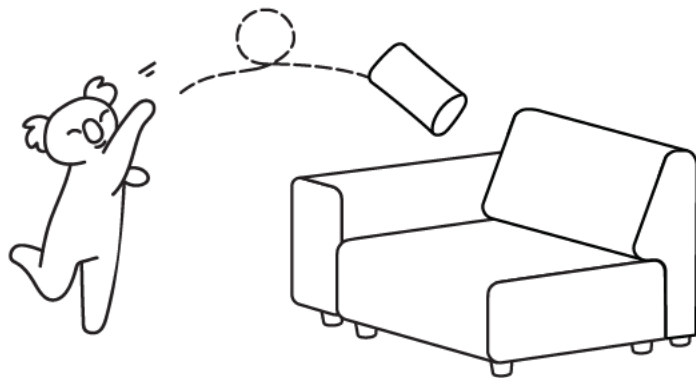

place your throw cushion

8.

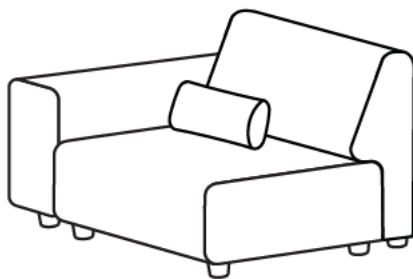

enjoy now or add to your collection

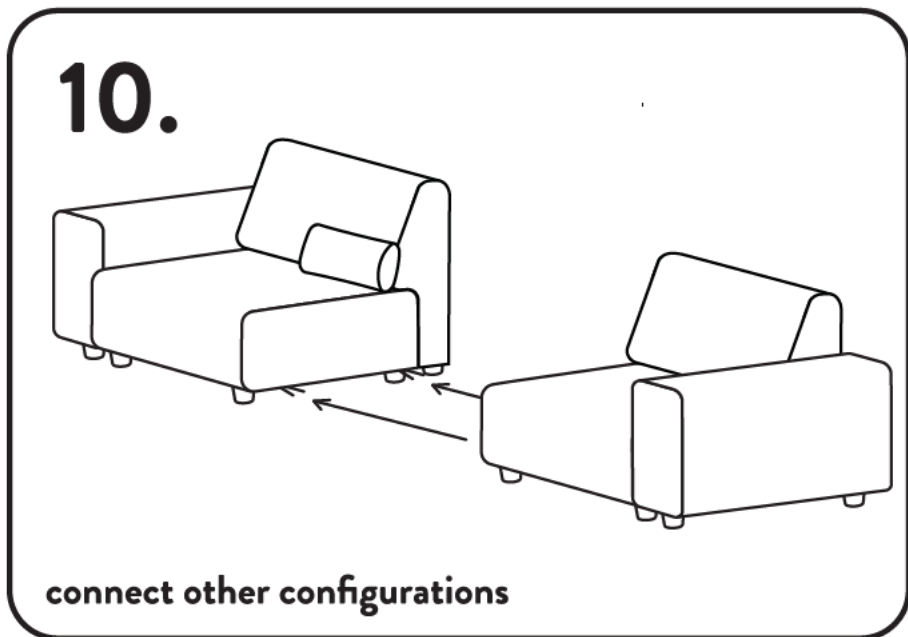
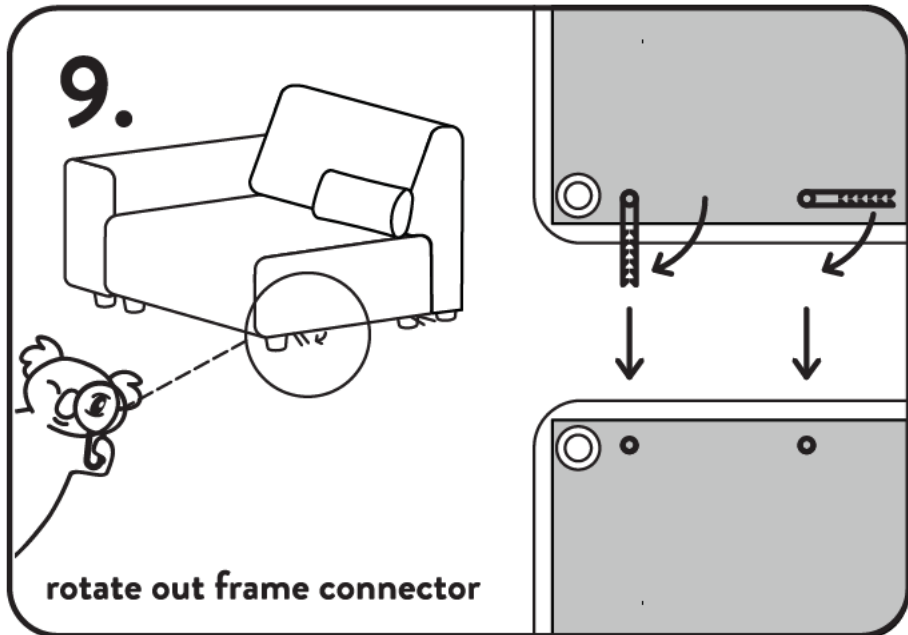

11.

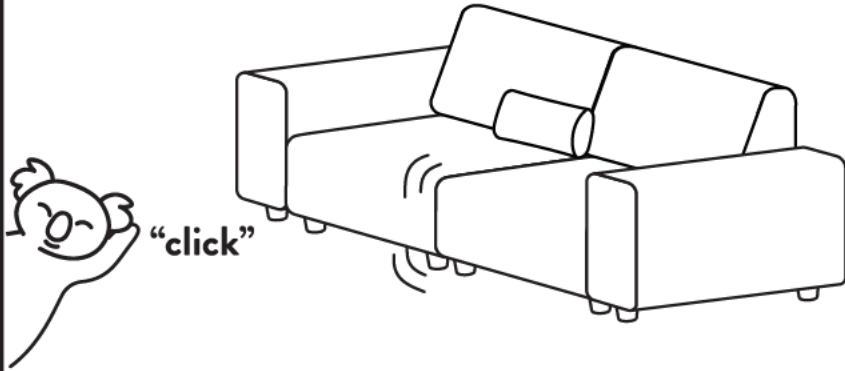

listen for click

12.

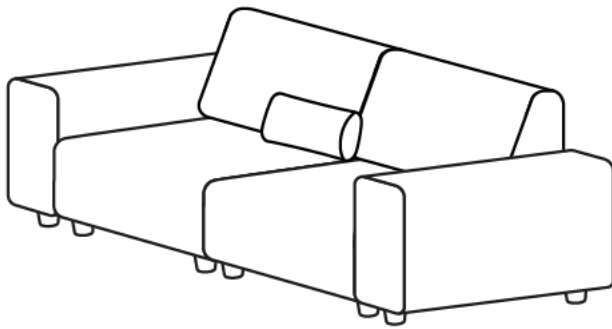

enjoy now or ...

13.

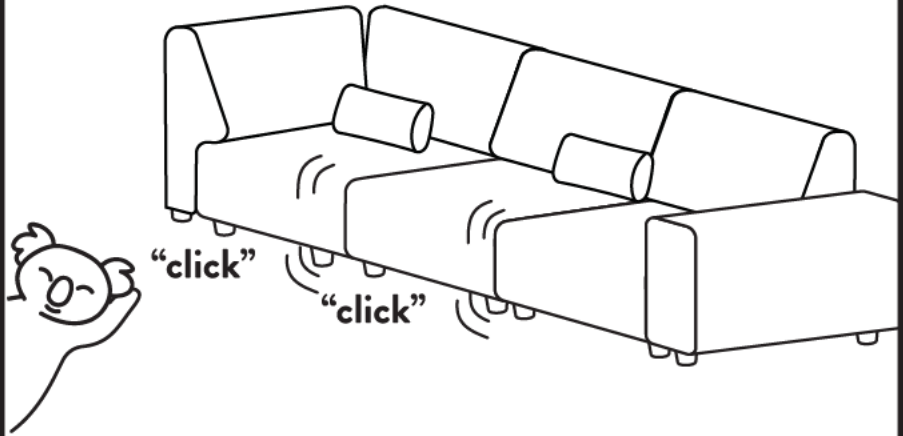

add to your collection

14.

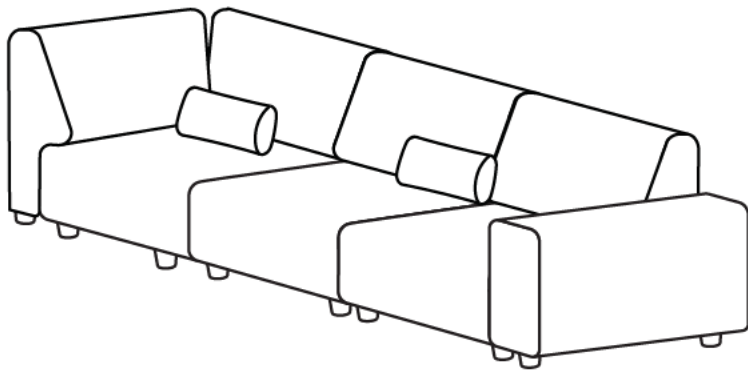

enjoy

#loungewithkoala

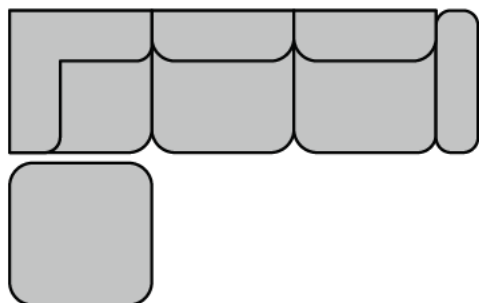
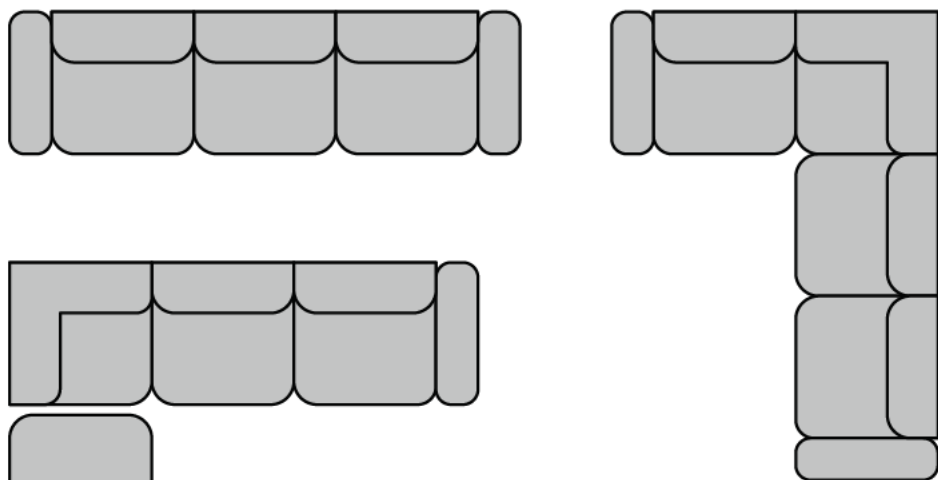
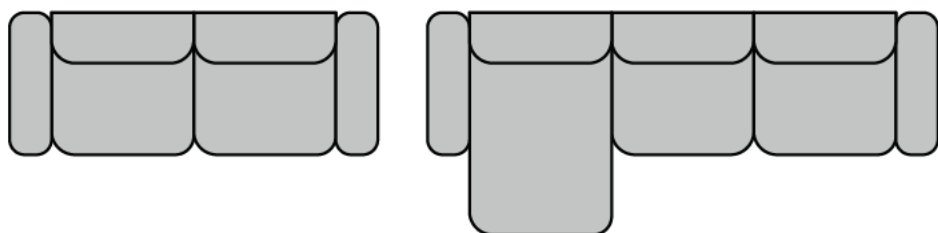
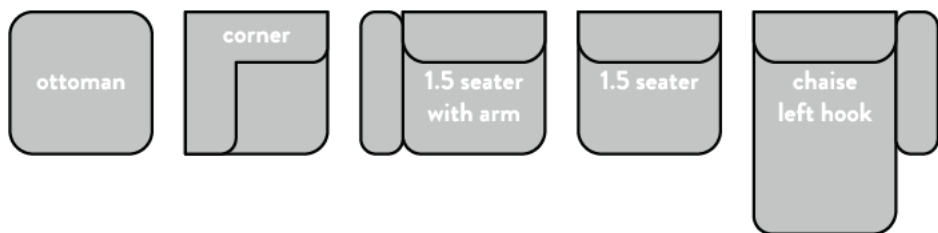



don't forget to recycle

koala