

kóala

1.5 seater (no arms)

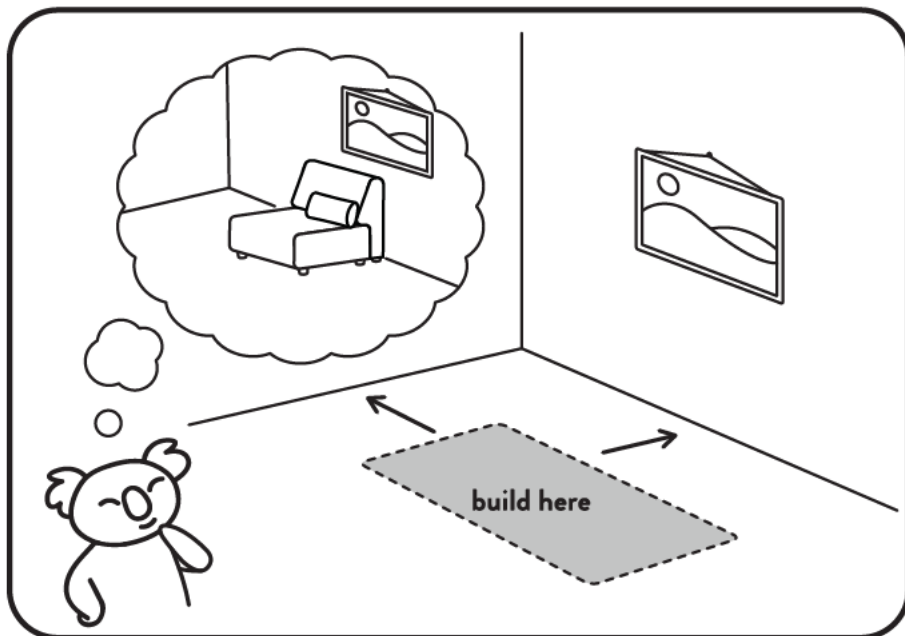

1.

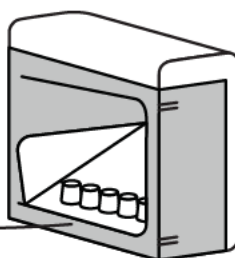

unscrew all legs from inside zip pocket

2.

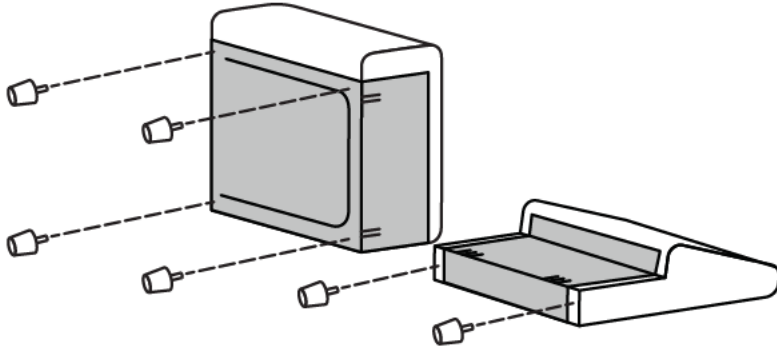

screw legs into all parts

3.

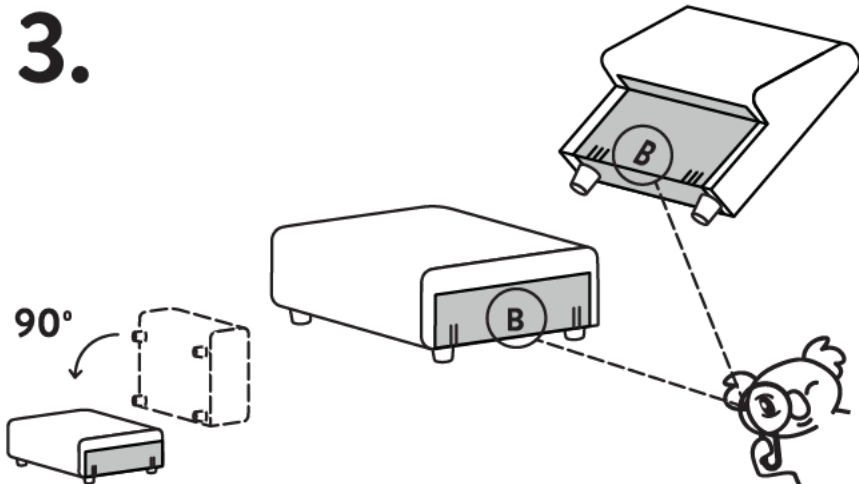

"B" for backrest

4.

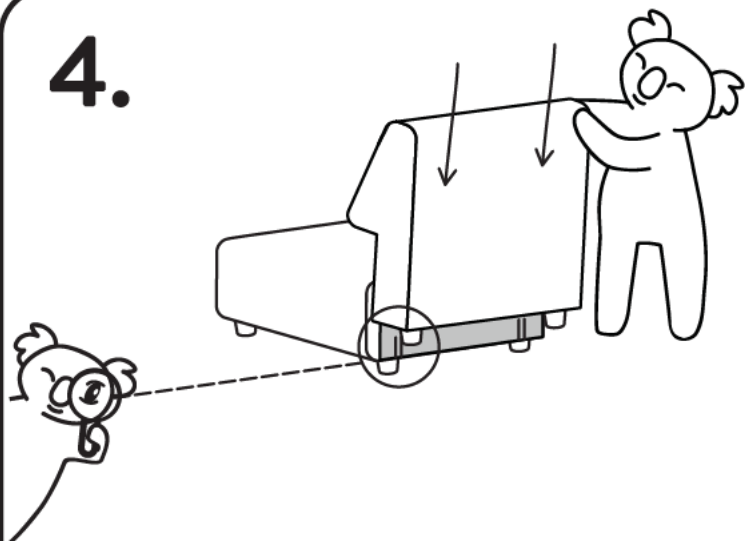

align connections and push down

5.

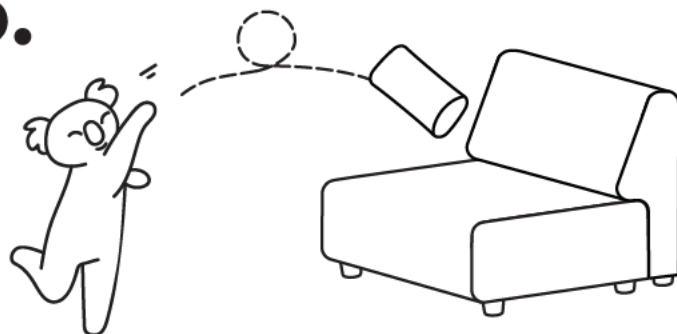

place your throw cushion

6.

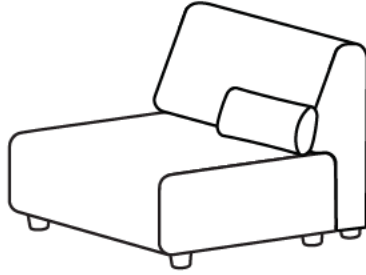

enjoy now or add to your collection

7.

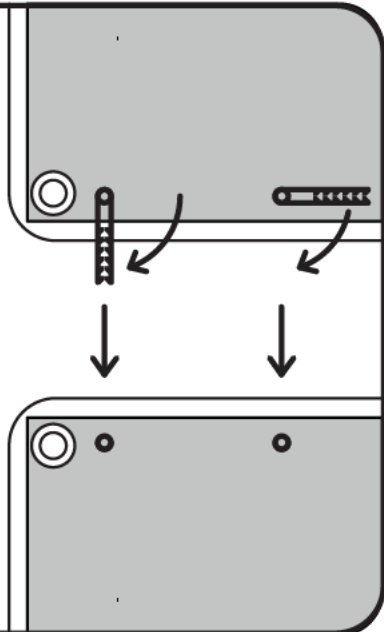
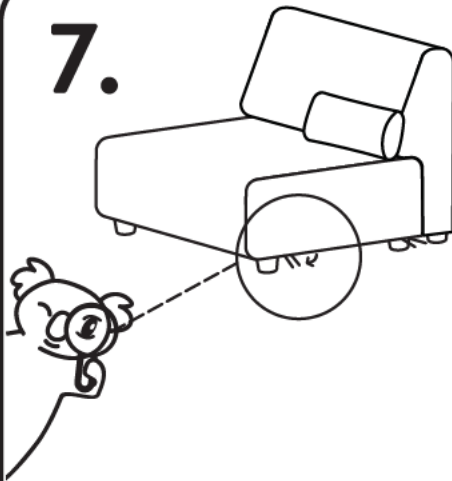

rotate out frame connector

8.

connect other configurations



“click”

listen for click

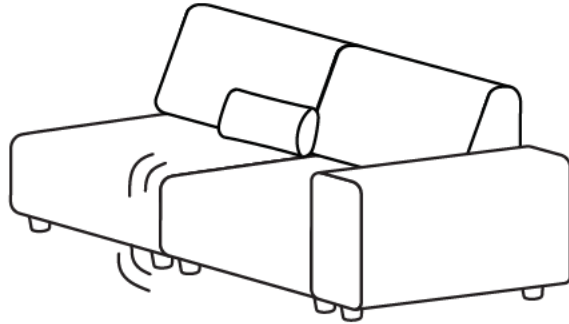

9.

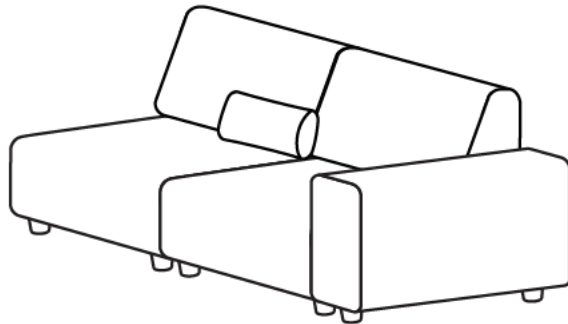

enjoy now or add to your collection

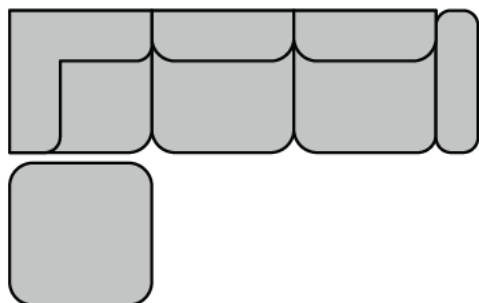
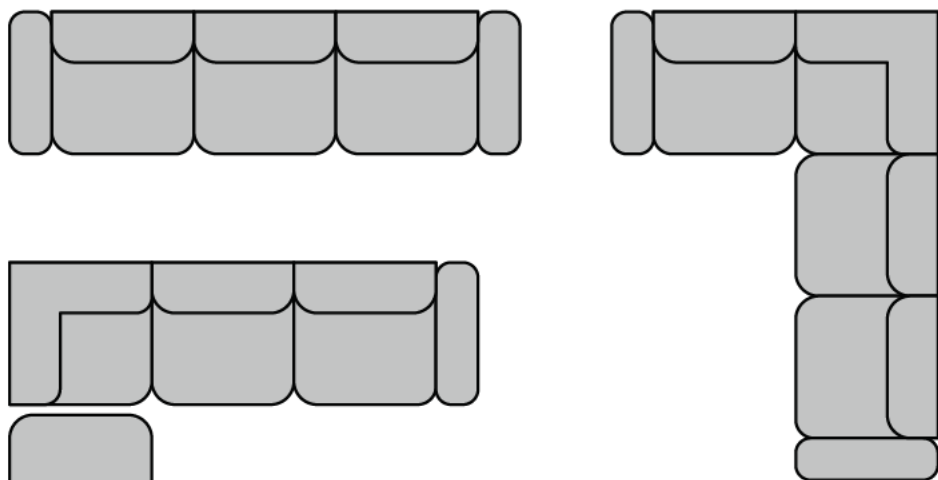
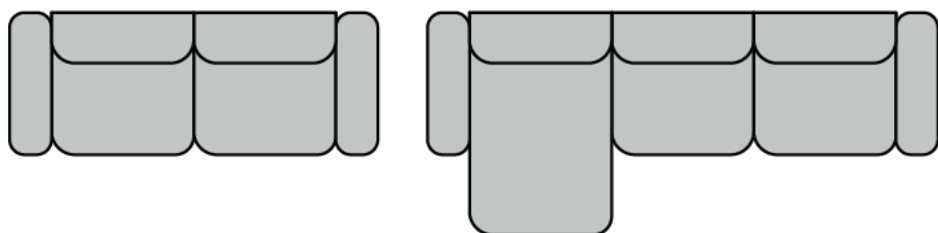
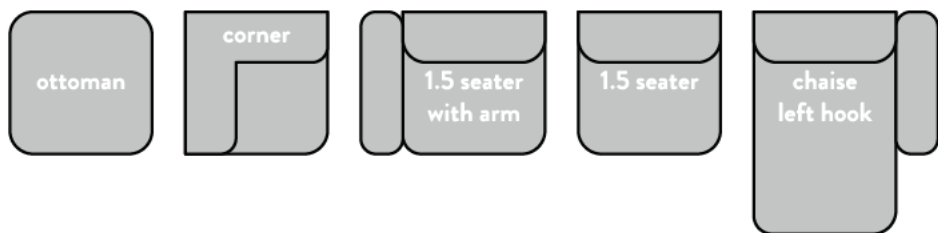

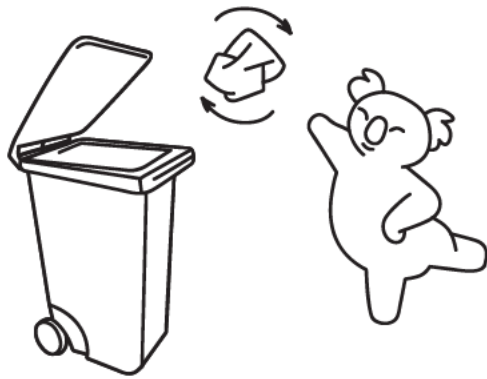

don't forget to recycle

koala