

emotional, refined,
contemporary, timeless,
charming, protagonist,
source of inspiration,
graphic impact ...
in a word, **the room.**

the
room



 **imola**
TILES FULL OF LIFE



ONYX WHITE ABSOLUTE



STATUARIO VENA PICCOLA



INV WHITE



PANDA WHITE



QUARTZITE PATAGONIA



CREMO DELICATO



SAN PEDRO



BLACK DAHLIA



GREY ROOTS



GRIS BRECHE DUMAS

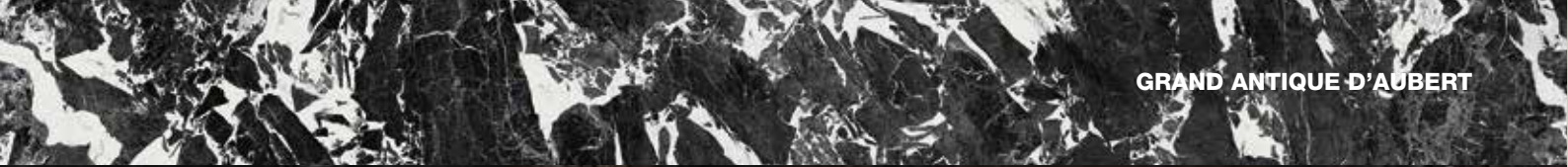

GRAND ANTIQUE D'AUBERT



INFINITY BRAZIL



ONYX AQUA BLUE GOLD

the
room

the room racconta
la ricchezza espressiva
di una selezione di
marmi pregiati,
interpretati attraverso
un linguaggio accogliente
e contemporaneo.

the room describes
the expressive opulence
of a selection of
quality marbles,
interpreted in a
welcoming, modern
language.



**ONYX WHITE
ABSOLUTE
P. 6**



**STATUARIO VENA
PICCOLA
P. 16**



**INV
WHITE
P. 24**



**PANDA
WHITE
P. 34**



**QUARTZITE
PATAGONIA
P. 42**



**CREMO
DELICATO
P. 54**



**SAN
PEDRO
P. 62**



**BLACK
DAHLIA
P. 70**



**GREY
ROOTS
P. 78**



**GRIS BRECHE
DUMAS
P. 92**



**GRAND ANTIQUE
D'AUBERT
P. 100**



**INFINITY
BRAZIL
P. 108**



**ONYX AQUA BLUE
GOLD
P. 118**

onyx white absolute



EDITION 2021

THE ROOM

L'onice calcarea ha origini ben lontane nella storia: è il 'marmor alabastrum' dei Latini ove alabastrum deriva da una fortezza detta "Alabastra", costruita a Tebe in Egitto e dove vi erano numerose cave usate per l'edificazione dei templi. Questa tipologia di marmo in natura si contraddistingue per la sua intensa lucentezza innestata in un fondo chiaro, con bande di vario spessore che vanno dall'avorio al color vaniglia.

The origins of the limestone onyx go way back in history: it is the 'marmor alabastrum' of the Latins where alabastrum derives from a fortress known as "Alabastra" built in Thebes in Egypt and where there were a number of quarries used to build the temples. This kind of marble in nature makes its mark thanks to its intense shine inserted into a clear background, and stands out for its strips of varying thickness that range in colour from ivory to vanilla.











ABS WH

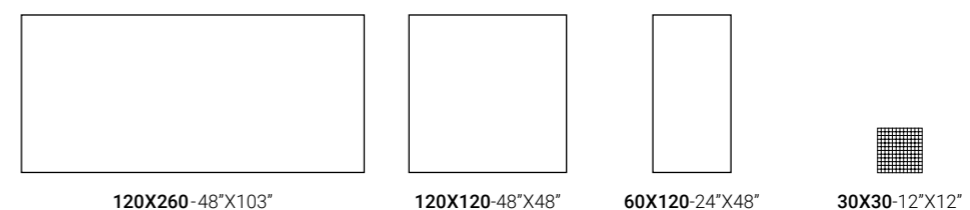

		ABS WH6 120 RM	ABS WH6 12 RM	MK.ABS WH6 30 (T144)
		ABS WH6 260 LP	ABS WH6 120 LP	ABS WH6 12 LP

statuario vena piccola



Il marmo Statuario Venato di prima qualità, di provenienza italiana, ha una grana fine e presenta un fondo puro, color bianco latte, con vene grigie di piccola e media larghezza. In natura è presente in quantità molto limitate rispetto agli altri marmi bianchi di Carrara.

Top quality Statuario Venato marble from Italy is fine veined with a pure, milky white background and grey veins of small and medium width. It occurs naturally in very small quantities compared to other white Carrara marbles.













STA VP

				
120X260-48"X103"	120X120-48"X48"	60X120-24"X48"	60X60-24"X24"	30X30-12"X12"
STA VP6 260 RM	STA VP6 120 RM	STA VP6 12 RM	STA VP6 60 RM	MK.STA VP6 30
STA VP6 260 LP	STA VP6 120 LP	STA VP6 12 LP	STA VP6 60 LP	



inv white

THE ROOM



Un marmo estratto in Asia Minore, composto quasi unicamente di Dolomia che si è trasformata col tempo e col calore in una pietra cristallina e leggermente trasparente. È caratterizzato da uno sfondo bianco attraversato da un reticolo largo di venature grigie che a volte hanno piccole sedimentazioni quasi ambrate.

A marble extracted in Asia Minor and made up almost exclusively of dolomite rock which transformed over time and with the heat into a crystalline, slightly transparent stone. It has a white background widely laced with grey veins which sometimes present small almost amber sedimentations.















INV WHITE

THE ROOM

GRES PORCELLANATO COLORATO IN MASSA
COLOR BODY PORCELAIN TILE



INV WH

			
120X260-48"X103"	120X120-48"X48"	60X120-24"X48"	30X30-12"X12"
 	INV WH6 120 RM INV WH6 120 LP	INV WH6 12 RM INV WH6 12 LP	MK.INV WH6 30 (T 144)



panda white

Un marmo davvero sorprendente che proviene dall'Estremo Oriente. È fortemente caratterizzato da uno sfondo bianco, accentuato da linee di un nero intenso a strisce più larghe o onde più spesse, il tutto completato da una cristallizzazione bianca su fondo chiaro che ne sottolinea la trasparenza.

It is a truly surprising marble from the Far East. It is strongly characterised by a very white background, accentuated by intense black lines with wider stripes or thicker waves and all completed with a white crystallization on the clear base which highlights its transparency.













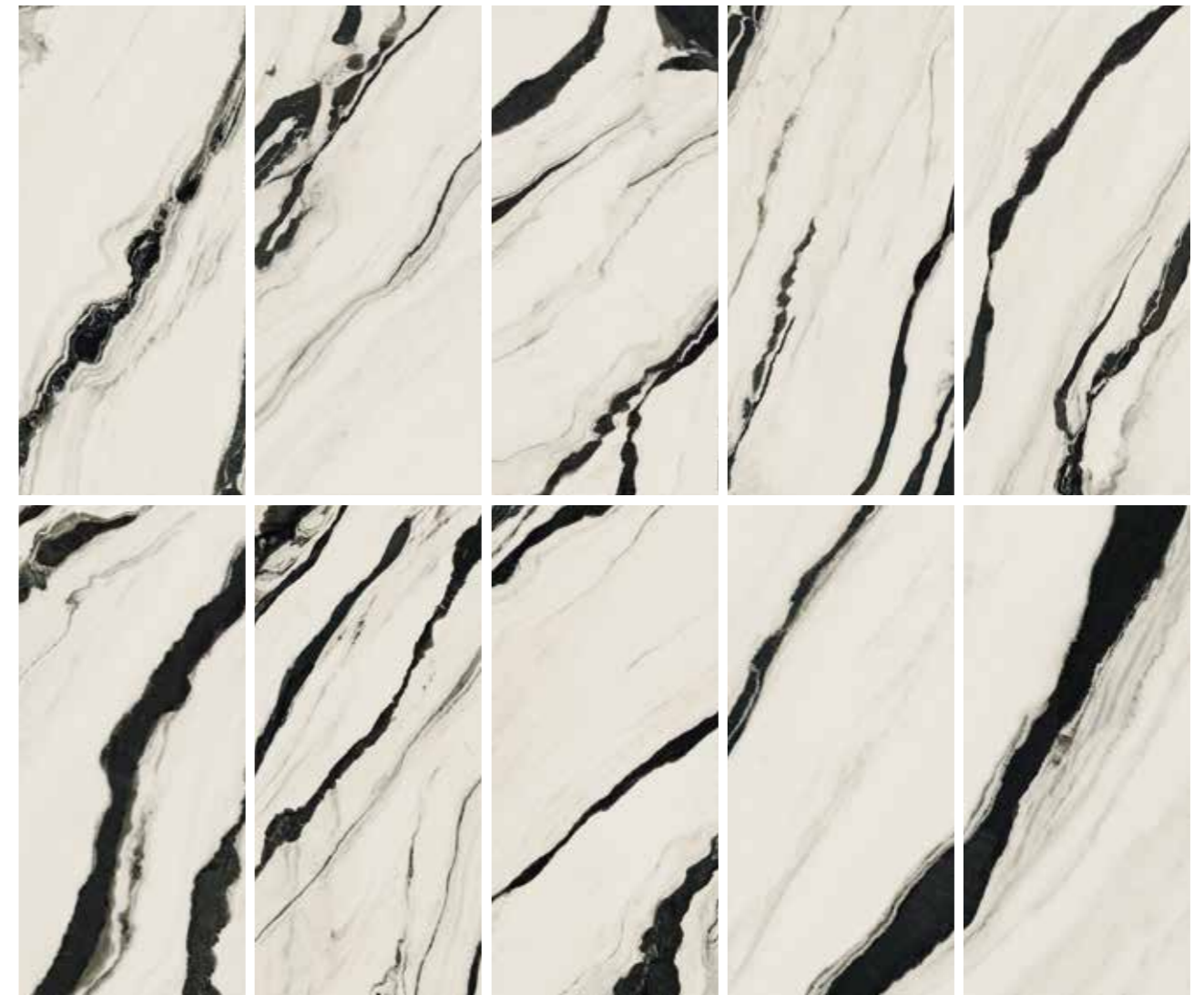





PANDA WHITE

THE ROOM

GRES PORCELLANATO COLORATO IN MASSA
COLOR BODY PORCELAIN TILE



PAN WH

			
120X260-48"X103"	120X120-48"X48"	60X120-24"X48"	30X30-12"X12"
 	 	 	 
PAN WH6 260 LP	PAN WH6 120 LP	PAN WH6 12 LP	MK.PAN WH6 30 (T 144)

quartzite patagonia



È una delle pietre più particolari e scenografiche esistenti in natura. Estratta in Sudamerica, in particolare in Brasile, è di origine vulcanica e la sua struttura geologica è dovuta a milioni di anni di attività sismica. Il magma risalendo verso la superficie, raffreddandosi, si è cristallizzato incorporando al proprio interno le rocce e i minerali incontrati nel corso del suo cammino.

It is one of the most unusual and attractive stones that exists in nature. Quarried in South America, especially in Brazil, its origins are volcanic and its geological structure comes from millions of years of seismic activity. As the magma rose to the surface and cooled, it crystallised and incorporated all the rocks and minerals it encountered on its path.











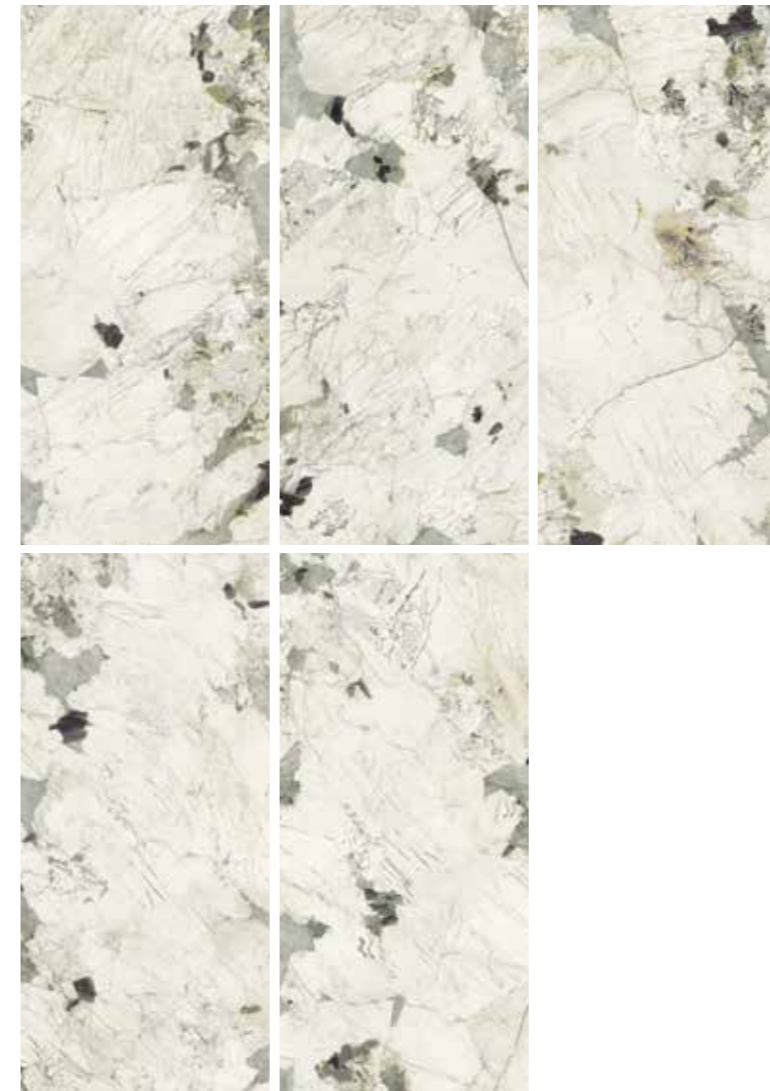

PAT WH

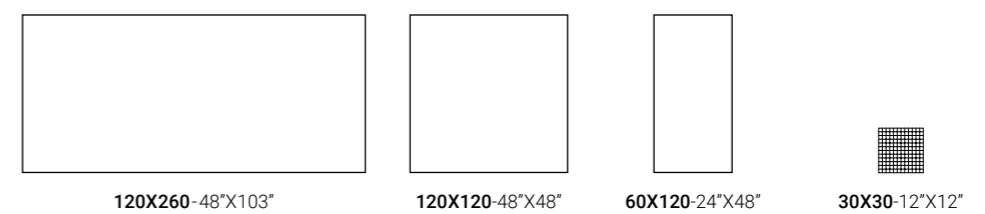

	PAT WH6 120 RM	PAT WH6 12 RM	MK.PAT WH6 30 (T144)
PAT WH6 260 LP	PAT WH6 120 LP	PAT WH6 12 LP	



cremo delicato

Un raffinato marmo italiano, caratterizzato dal colore di fondo bianco avorio con una presenza saltuaria di bande e rare venature grigio/giallastre allineate in senso longitudinale.

It is an elegant Italian marble, which features a white ivory background with occasional bands and rare grey/yellowish veins aligned longitudinally.



THE ROOM





CREMO DELICATO

THE ROOM

GRES PORCELLANATO COLORATO IN MASSA
 COLOR BODY PORCELAIN TILE



CRE DL

120X260-48"X103"	120X120-48"X48"	60X120-24"X48"	60X60-24"X24"	30X30-12"X12"
CRE DL6 260 RM	CRE DL6 120 RM	CRE DL6 12 RM	CRE DL6 60 RM	MK.CRE DL6 30
CRE DL6 260 LP	CRE DL6 120 LP	CRE DL6 12 LP	CRE DL6 60 LP	

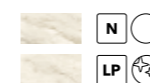



san pedro

Dall'Asia Minore proviene San Pedro, conosciuto anche come Silver Roots, dalla colorazione di fondo che può variare dal grigio tortora al beige intenso, con profonde venature scure e sottili di colore marrone tendente al rossiccio.

San Pedro, also known as Silver Roots, is from Asia Minor. Its background colour can vary from dove grey to rich beige, with deep, dark and thin veins of a brown to reddish hue.



THE ROOM





THE ROOM



SAN PE

120X260-48"X103"	120X120-48"X48"	60X120-24"X48"	60X60-24"X24"	30X30-12"X12"
SAN PE6 260 RM	SAN PE6 120 RM	SAN PE6 12 RM	SAN PE6 60 RM	MK.SAN PE6 30
SAN PE6 260 LP	SAN PE6 120 LP	SAN PE6 12 LP	SAN PE6 60 LP	



black dahlia



Proveniente dal Centro America, è una pietra che appartiene alla famiglia degli Onici Silicei. Solitamente di tonalità nera striata di bianco, è arricchita di particolari incredibili che possono variare dal giallo al marrone, fino ad arrivare quasi al rosso passando attraverso l'avorio ed il grigio.

Black Dahlia comes from central America and is a stone belonging to the silicate onyx category. Generally black with white streaks, it is enriched with incredible details that can vary from yellow to brown, even as far as red via ivory and grey.







THE ROOM







BLACK DAHLIA

THE ROOM

GRES PORCELLANATO COLORATO IN MASSA
 COLOR BODY PORCELAIN TILE



BLA DA

			
120X260-48"X103"	120X120-48"X48"	60X120-24"X48"	30X30-12"X12"
 	BLA DA6 120 RM	BLA DA6 12 RM	MK.BLA DA6 30 (T144)
BLA DA6 260 LP	BLA DA6 120 LP	BLA DA6 12 LP	

grey roots



Un marmo di particolare fascino, originario dell'Anatolia, caratterizzato da un luminoso colore di fondo, il grigio argento, ed arricchito da zone miscelate tra loro che vanno dalle tonalità del bianco al grigio. Sulla superficie affiorano increspature e solchi dai toni caldi dell'oro e del crema che donano un effetto di piacevole contrasto con lo sfondo grigio, conferendo al Grey Roots un senso di antica regalità e valore.

A particularly appealing marble, originally from Anatolia, characterised by a bright silvery-grey background colour, and enriched by areas mixed together, ranging from white to grey shades. Ripples and cracks appear on the surface in warm shades of gold and cream that give it a pleasant contrasting effect against the grey background, giving the Grey Roots a sense of ancient regality and value.













GREY ROOTS

EDITION 2021
THE ROOM

GRES PORCELLANATO COLORATO IN MASSA
COLOR BODY PORCELAIN TILE



GRE RO

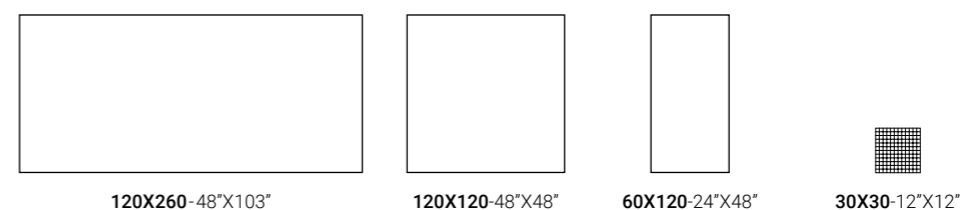

	GRE RO6 120 RM	GRE RO6 12 RM	MK.GRE RO6 30 (T144)
GRE RO6 260 LP	GRE RO6 120 LP	GRE RO6 12 LP	

gris breche dumas



E' il nome conferito a questa breccia, originaria dei Pirenei, in omaggio al noto drammaturgo francese Alexander Dumas. Un marmo sempre più difficile da reperire poiché la cava di estrazione è sostanzialmente esaurita. Per Imola l'intento è stato quello di riproporre sulla lastra ceramica l'estetica francese di questa roccia che si contraddistingue da un morbido e luminoso grigio chiaro di fondo e da sottili venature e sfumature tono su tono.

This is the name given to this pebble, originally from the Pyrenees, as a tribute to the famous French playwright, Alexander Dumas. An increasingly difficult marble to find because the quarries are basically empty. Imola's aim was to reproduce the French look of this rock on this ceramic slab that makes its mark with its soft, shiny light grey background and fine veining and tone-on-tone shades.

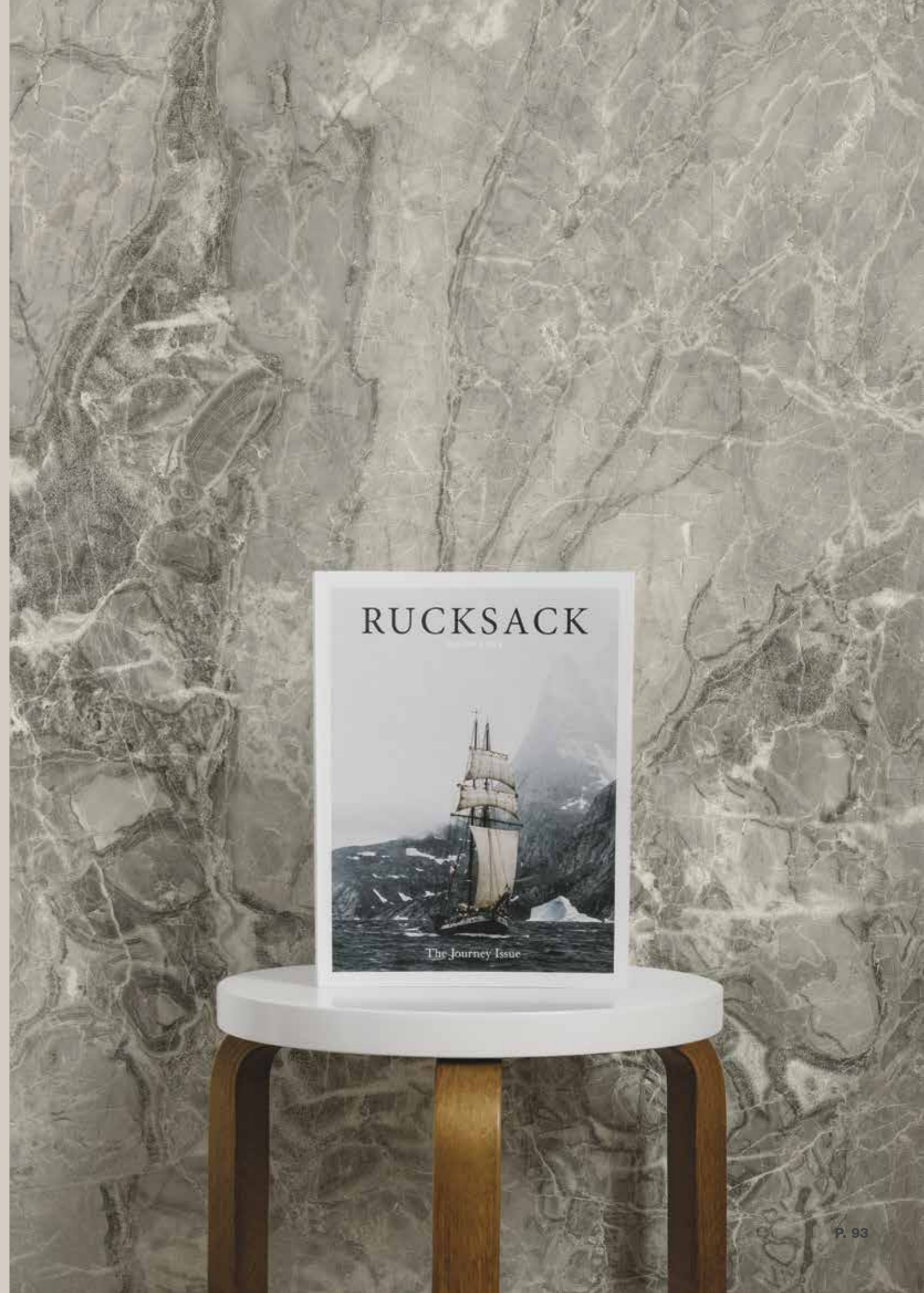

THE ROOM







BRE DU

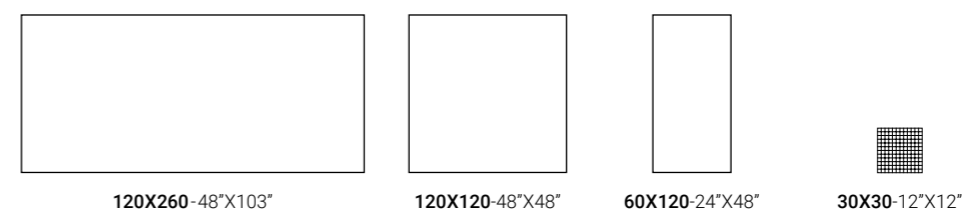

	BRE DU6 120 RM	BRE DU6 12 RM	MK.BRE DU6 30 (T144)
BRE DU6 260 LP	BRE DU6 120 LP	BRE DU6 12 LP	



grand antique d'aubert

E' una pietra estratta in Francia nei Pirenei settentrionali. La cava, chiusa per quasi 70 anni, è stata riaperta solo ultimamente. Famosissime le sue applicazioni nel mondo fra le quali la tomba di Napoleone. Si presenta a macchie bianche e nere con contrasti così definiti che non si possono trovare in nessun altro marmo presente in natura.

It is a stone extracted in France in the northern Pyrenees. The quarry, closed for almost 70 years, has only recently be re-opened. It has been used on some extremely famous occasions, including for Napoleon's tomb. Its black and white marks with such defined contrasts have never been seen in any other marble found in nature.



THE ROOM



THE ROOM

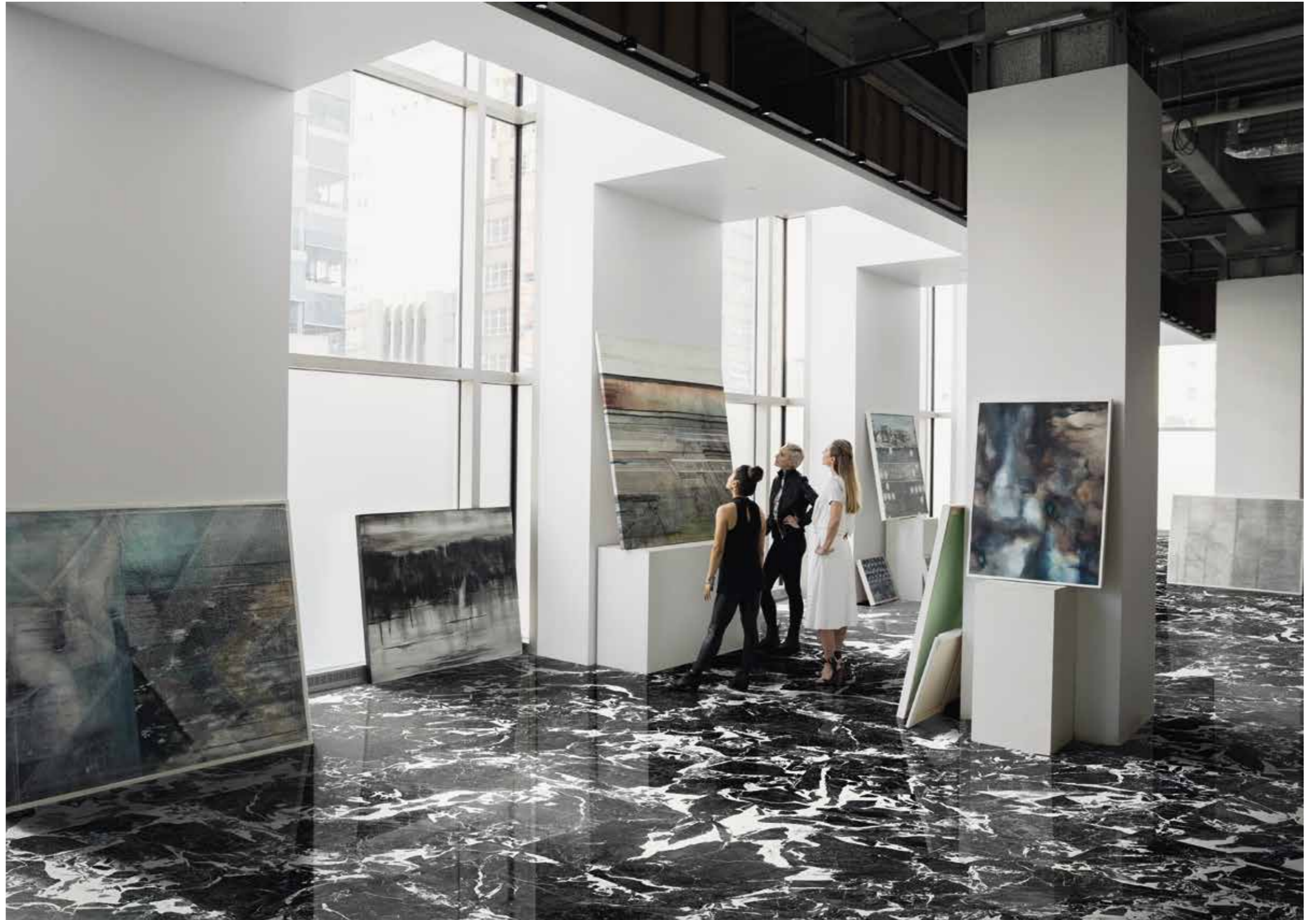



THE ROOM

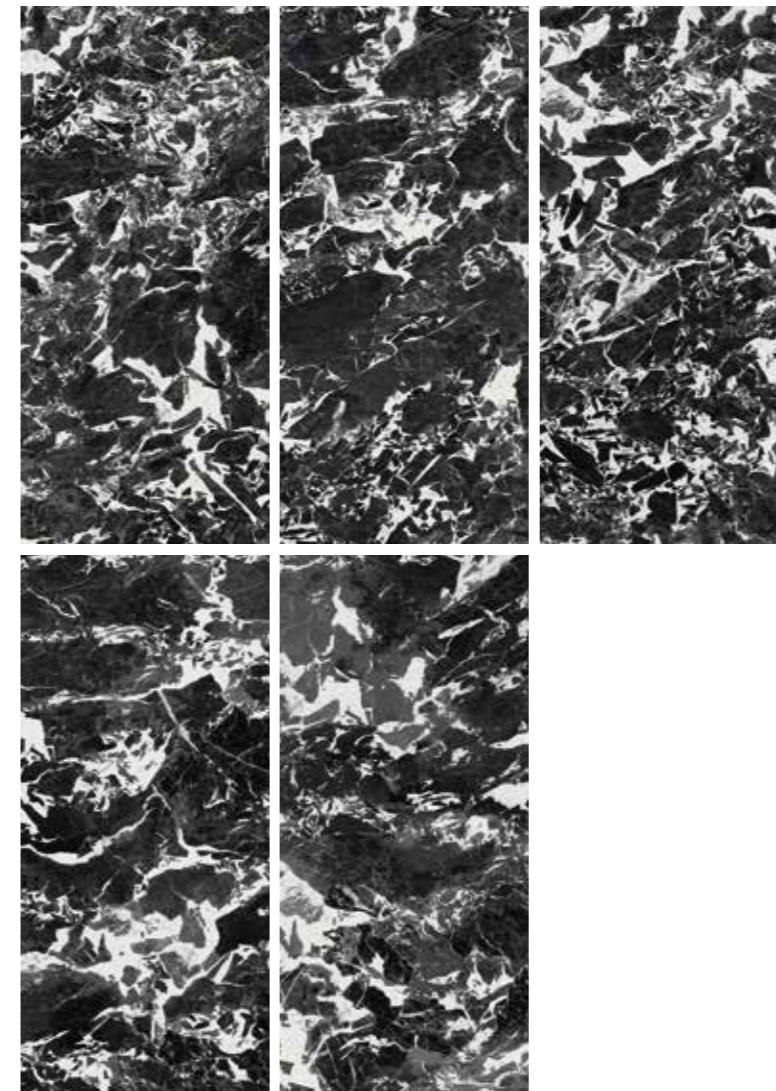

GRA AN

120X260-48"X103"	120X120-48"X48"	60X120-24"X48"	30X30-12"X12"
	GRA AN6 120 RM	GRA AN6 12 RM	MK.GRA AN6 30 (T144)
GRA AN6 260 LP	GRA AN6 120 LP	GRA AN6 12 LP	



infinity brazil

Dal Sudamerica, Infinity Brazil, una rara quarzite di colore nero intenso e particolarmente elegante. La caratteristica tonalità nera è intervallata da punti di luce che ne esaltano lo splendore e la lucentezza.

From South America, Infinity Brazil is a rare quartzite with an especially elegant rich black colour. Its characteristic black hue is interspersed with points of light that enhance its brilliance and lustre.



THE ROOM



THE ROOM



THE ROOM



GRES PORCELLANATO COLORATO IN MASSA
 COLOR BODY PORCELAIN TILE



INF BR

120X260-48"X103"	120X120-48"X48"	60X120-24"X48"	60X60-24"X24"	30X30-12"X12"
INF BR6 260 RM	INF BR6 120 RM	INF BR6 12 RM	INF BR6 60 RM	MK.INF BR6 30
INF BR6 260 LP	INF BR6 120 LP	INF BR6 12 LP	INF BR6 60 LP	



onyx aqua blue gold

THE ROOM EDITION 2021



Il marmo onice è formato da sedimenti calcarei colorati di acqua sorgiva e d'infiltrazione. Di provenienza asiatica, è un minerale che si caratterizza per il suo effetto di splendente trasparenza in superficie: una proprietà che lo rende molto raro e particolarmente adatto per gli elementi d'interni dall' elevato tocco di esclusività. Colori frequenti sono il giallo, il marrone, il rosso e il verde, declinati in sfumature inimmaginabili.

The onyx marble is made up of sedimentary limestone coloured by spring water and infiltration. Of Asiatic origin, it is a mineral that stands out for its shiny transparency effect on the surface: a feature that makes it extremely rare and particularly suited to interior design objects with a strong hint of exclusivity. Recurring colours include yellow, brown, red and green, that appear in unimaginable shades.





THE ROOM EDITION 2021





ONYX AQUA BLUE GOLD

EDITION 2021
THE ROOM

GRES PORCELLANATO COLORATO IN MASSA
COLOR BODY PORCELAIN TILE

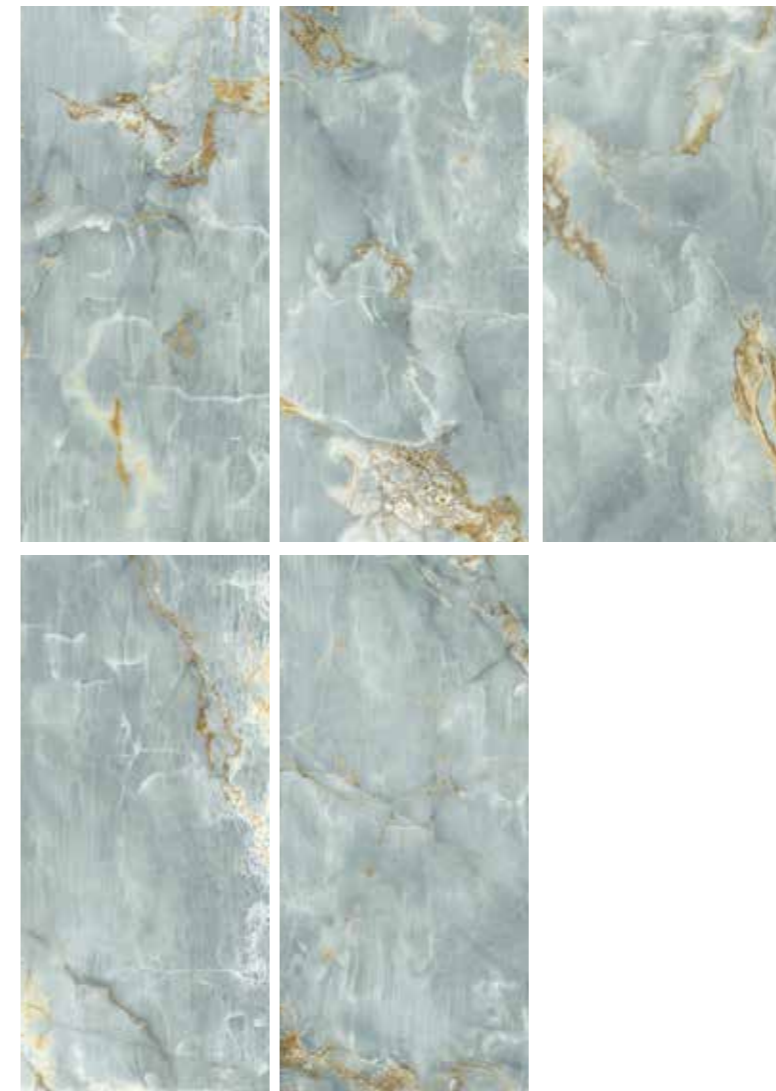

BLU AQ

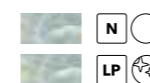
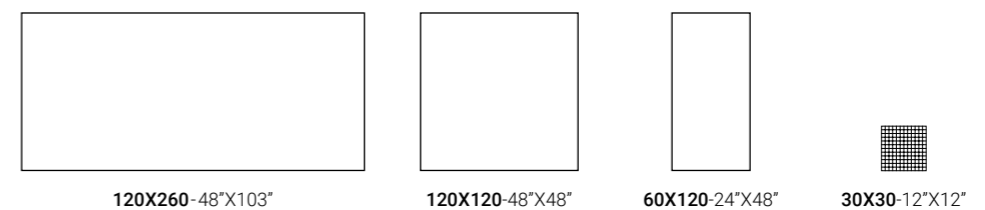

	BLU AQ6 120 RM	BLU AQ6 12 RM	MK.BLU AQ6 30 (T144)
BLU AQ6 260 LP	BLU AQ6 120 LP	BLU AQ6 12 LP	



**elementi decorativi
pezzi speciali.
decorative elements
special pieces.**





THE ROOM EDITION 2021

GRES PORCELLANATO COLORATO IN MASSA
COLOR BODY PORCELAIN TILE



ORYX6 260LP
120X260-48"X103"



ORYX6 12LP
60X120-24"X48"





THE ROOM EDITION 2021

GRES PORCELLANATO COLORATO IN MASSA
COLOR BODY PORCELAIN TILE



JAGUAR6 260LP
120X260-48"X103"



JAGUAR6 12LP
60X120-24"X48"



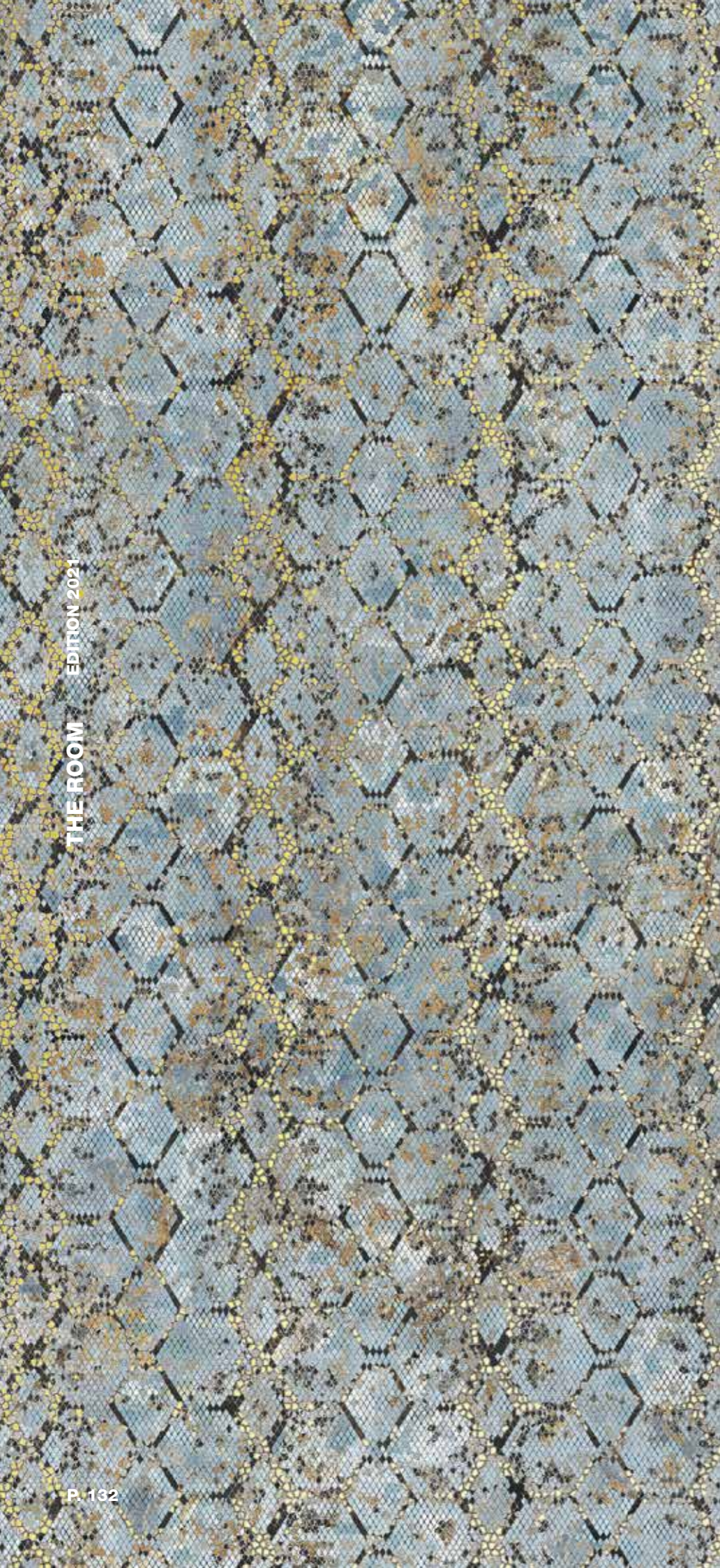

THE ROOM EDITOR 2021

GRES PORCELLANATO COLORATO IN MASSA
COLOR BODY PORCELAIN TILE

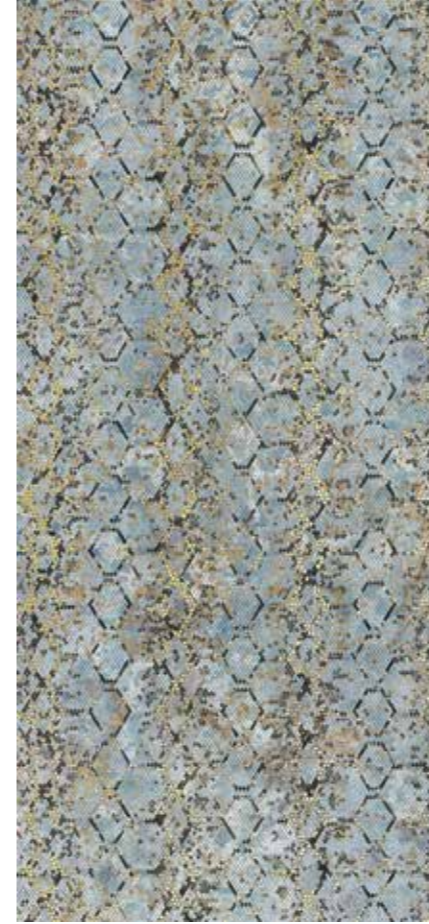

PYTHON6 260LP
120X260-48"X103"



PYTHON6 12LP △ 2
60X120-24"X48"



THE ROOM

GRES PORCELLANATO COLORATO IN MASSA
COLOR BODY PORCELAIN TILE



TURTLE6 260LP
120X260-48"X103"

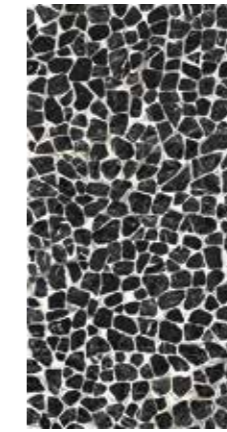

TURTLE6 12LP △ 2
60X120-24"X48"



THE ROOM

GRES PORCELLANATO COLORATO IN MASSA
COLOR BODY PORCELAIN TILE



SNAKE6 260LP
120X260-48"X103"



SNAKE6 12LP
60X120-24"X48"





THE ROOM

GRES PORCELLANATO COLORATO IN MASSA
COLOR BODY PORCELAIN TILE



GHEPARD6 260LP
120X260-48"X103"



GHEPARD6 12LP △ 2
60X120-24"X48"



GHEPARD6 120LP
120X120-48"X48"



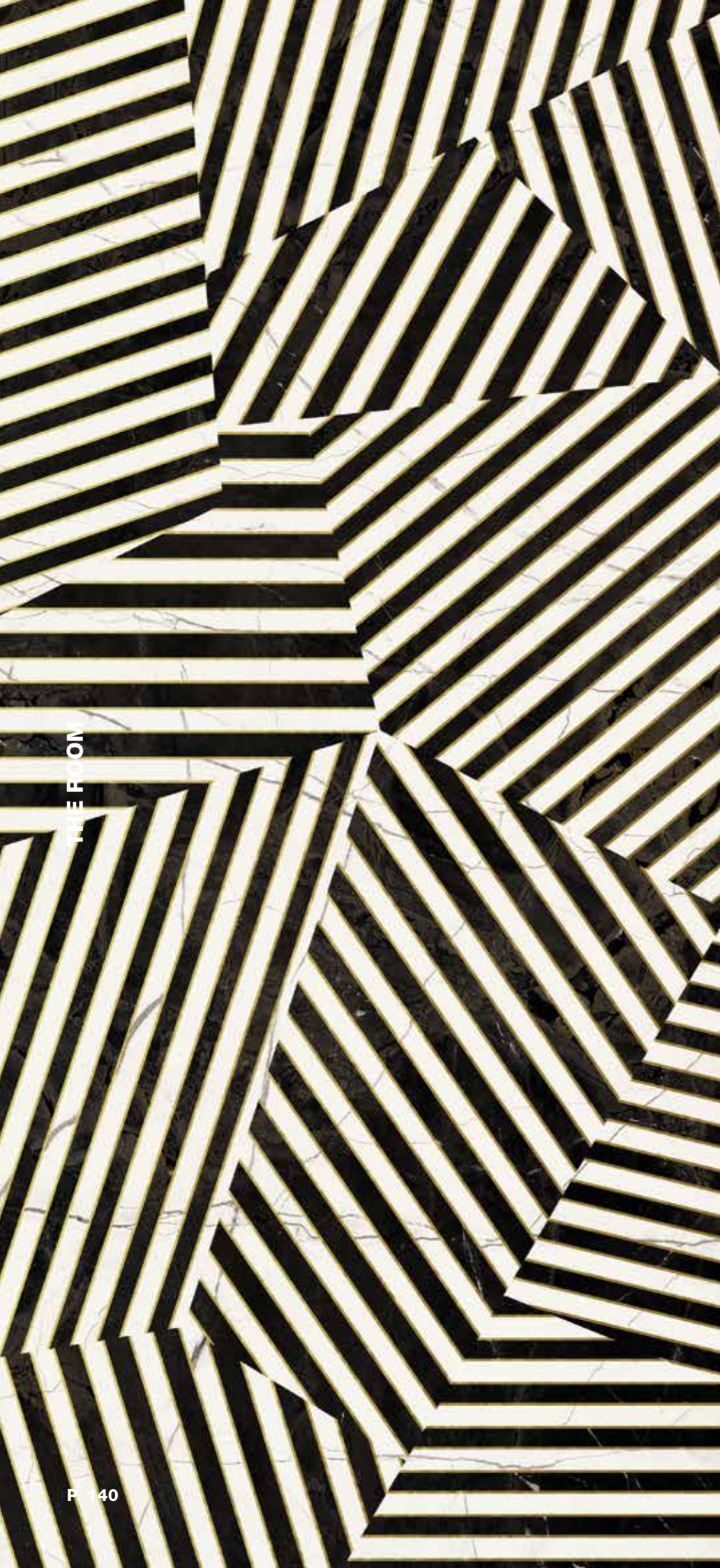

THE FLOOR

GRES PORCELLANATO COLORATO IN MASSA
COLOR BODY PORCELAIN TILE



ZEBRA6 260LP
120X260-48"X103"



ZEBRA6 12LP
60X120-24"X48"



ZEBRA6 120LP
120X120-48"X48"





the room

GRES PORCELLANATO COLORATO IN MASSA
COLOR BODY PORCELAIN TILE

PEZZI SPECIALI / SPECIAL PIECES

	6X120-2.4"X48" △ 8	6X120-2.4"X48" △ 8
ABS WH	ABS WH6 BT120	ABS WH6 BT120LP
STA VP	STA VP6 BT120	STA VP6 BT120LP
INV WH	INV WH6 BT120	INV WH6 BT120LP
PAN WH	PAN WH6 BT120	PAN WH6 BT120LP
PAT WH	CRE DL6 BT120	CRE DL6 BT120LP
CRE DL	CRE DL6 BT120	CRE DL6 BT120LP
SAN PE	SAN PE6 BT120	SAN PE6 BT120LP
BLA DA	BLA DA6 BT120	BLA DA6 BT120LP
GRE RO	GRE RO6 BT120	GRE RO6 BT120LP
BRE DU	BRE DU6 BT120	BRE DU6 BT120LP
GRA AN	GRA AN6 BT120	GRA AN6 BT120LP
INF BR	INF BR6 BT120	INF BR6 BT120LP
BLU AQ	BLU AQ6 BT120	BLU AQ6 BT120LP

IMBALLI / PACKAGING

FORMATO NOMINALE NOMINAL SIZE	BORDO EDGE	SPESSORE THICKNESS	BOX			PALLET		
			PZ/BOX PCS/BOX	MQ/BOX SM/BOX	KG/BOX KG/BOX	BOX/PALLET BOXES/PALLET	MQ/PALLET SM/PALLET	KG/PALLET KG/PALLET
120X260-48"X103"	RECTIFIED	6,5	1	3,12	49,02	20	62,40	1000,40
120X120-48"X48"	RECTIFIED	6,5	2	2,88	48,45	30	86,40	1473,50
60X120-24"X48"	RECTIFIED	6,5	4	2,88	48,30	16	46,08	792,80
60X60-24"X24"	RECTIFIED	6,5	5	1,80	28,60	32	57,60	935,20
30X30-12"X12" MOSAIC	RECTIFIED	6,5	6	0,54	7,48	72	38,88	558,20









CARATTERISTICHE TECNICHE SPECIFICHE / TECHNICAL FEATURES SPECIFICATIONS

	DIN 51130 (R)	DIN 51097 (A+B+C)	BCR REP. CEC 6/81		DM 14/6/89 N. 236		PENDULUM TEST BS (Inglese)	PENDULUM TEST AS/NZS 4856:2004 (AUSTRALIANO)	PENDULUM TEST UNE ENV 12633:2003 (SPAGNOLO)	BOT 3000 (DCOF)
			G.A.	G.B.	C.A.	G.B.				
THE ROOM	R9	A	>0.4	>0.4	>0.4	>0.4	>25	>25	1	>0,42

Caratteristiche Tecniche Gres Porcellanato

Technical Specifications Porcelain Stoneware

UNI EN 14411 (ISO 13006) - Bla (appendice/appendix G)

CARATTERISTICA Specification	METODO DI PROVA Test methods	REQUISITI PREVISTI DALLA NORMA Requirements in accordance to the standards	VALORE MEDIO IMOLA IMOLA average value
 DIMENSIONI E ASPETTO DIMENSIONS AND APPEARANCE	ISO 10545-2	PROSPETTO G.1 PROSPECT G.1	CONFORME COMPLIANT
 ASSORBIMENTO D'ACQUA WATER ABSORPTION	ISO 10545-3	≤ 0,5%	< 0,1%
 RESISTENZA A FLESSIONE FLEXURAL RESISTANCE		min. / МИН 35 N/mm ²	> 45 N/mm ²
	ISO 10545-4	SPESORE / THICKNESS ≥ 7,5 mm: min. 700 N	6,5 mm 1800 N*
SFORZO DI ROTTURA MODULUS OF RUPTURE		SPESORE* / THICKNESS*	10 mm* 3000 N*
		SPESORE / THICKNESS < 7,5 mm: min. 1300 N	20 mm* 13000 N*
 RESISTENZA ALL'ABRASIONE PROFONDA DEEP ABRASION RESISTANCE	ISO 10545-6	≤ 175 mm ³	< 140 mm ³
 COEFFICIENTE DILATAZIONE TERMICA LINEARE (α) LINEAR EXPANSION THERMIC COEFFICIENT	ISO 10545-8	METODO DISPONIBILE AVAILABLE ON REQUEST	≤ 7x10 ⁻⁶ °C ⁻¹
 RESISTENZA AGLI SBALZI TERMICI RESISTANCE TO SUDDEN TEMPERATURE CHANGES	ISO 10545-9	METODO DISPONIBILE AVAILABLE ON REQUEST	RESISTE RESISTANT
 RESISTENZA AL GELO FROST RESISTANCE	ISO 10545-12	RICHIESTA ALWAYS TESTED	RESISTE RESISTANT
 PRODOTTI CHIMICI AD USO DOMESTICO ED ADDITIVI PER PISCINA HOUSEHOLD CHEMICALS AND SWIMMING POOL WATER CLEANSERS		min. B МИН. B	min. B МИН. B
ACIDI ED ALCALI A BASSA CONCENTRAZIONE ACIDS AND LOW CONCENTRATION ALKALIS	ISO 10545-13	DA LA, LB A LC FROM LA, LB TO LC / DE LA, LB A LC	DA LA, LB A LC FROM LA, LB TO LC / DE LA, LB A LC
ACIDI ED ALCALI AD ALTA CONCENTRAZIONE ACIDS AND HIGH CONCENTRATION ALKALIS		METODO DISPONIBILE AVAILABLE ON REQUEST	METODO DISPONIBILE AVAILABLE ON REQUEST
 RESISTENZA ALLE MACCHIE UGL STAIN RESISTANCE UGL		METODO DISPONIBILE AVAILABLE ON REQUEST	METODO DISPONIBILE AVAILABLE ON REQUEST
	ISO 10545-14		
RESISTENZA ALLE MACCHIE GL STAIN RESISTANCE GL		min. 3 МИН. 3	min. 3 МИН. 3

*VALORI RIFERITI AL FORMATO 60X60 / VALUES REFERRED TO 60X60 SIZE

Symbologia Symbols



imolaceramica.com

Marketing CC Imola

INDICAZIONI D'USO INDICATIONS FOR USE

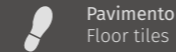

Pavimento
Floor tiles



Rivestimento
Wall tiles

DESTINAZIONI D'USO SUGGESTED APPLICATIONS



Abitazioni
Domestic purpose



Commerciale leggero
Light traffic area



Commerciale
Retail

SUPERFICI SURFACES

Struttura
Structure

Finitura
Finish



Naturale
Natural



* Lappato
Honed

Aspetto superficiale
Surface look



Opaco
Matt



* Lucido
Glossy

Bordo
Edge



Rettificato monocalibro
Monocaliber, rectified

STONALIZZAZIONE SHADE VARIATION

V2



SPESORE THICKNESS



6,5

IMBALLO PACKING



CARATTERISTICHE DI VENDITA SALES CHARACTERISTICS



Prodotto venduto al pezzo.
Product sold per item.

Tutti i nostri prodotti, sia al mq che al pezzo, sono venduti unicamente a scatola completa.
All our products are sold only in complete boxes, whether the unit of measure is per item or per square metre.



A brand of
Cooperativa Ceramica d'Imola S.c.

Via V. Veneto, 13
40026 Imola (BO) Italia
Tel. +39 0542 601601
Fax +39 0542 31749

* Le superfici con finitura lappata lucida e levigata sono consigliate per qualsiasi tipo di rivestimento e per pavimenti residenziali o per superfici calpestabili che non hanno un diretto collegamento con l'esterno o che hanno accessi protetti da appositi stuoi. Come è noto tutte le superfici lucide subiscono con l'uso un naturale processo di opacizzazione.
Nel caso dei materiali in gres porcellanato di Imola questo processo è più lento rispetto a qualsiasi altro materiale naturale lavorato a lucido come marmo, pietra, granito. / Surfaces with a honed and polished gloss finish are recommended for any kind of wall tile, residential floor or floors that are not directly connected with the outdoors or whose entrances are protected by mats. As is well known, all gloss surfaces naturally lose their shine over time. With Imola porcelain stoneware this process is slower than other honed natural materials like marble, granite or stone.

