



Development Kit User Guide

AirPrime WS Series



SIERRA
WIRELESS

4110996
2.0
February 08, 2013

Important Notice

Due to the nature of wireless communications, transmission and reception of data can never be guaranteed. Data may be delayed, corrupted (i.e., have errors) or be totally lost. Although significant delays or losses of data are rare when wireless devices such as the Sierra Wireless modem are used in a normal manner with a well-constructed network, the Sierra Wireless modem should not be used in situations where failure to transmit or receive data could result in damage of any kind to the user or any other party, including but not limited to personal injury, death, or loss of property. Sierra Wireless accepts no responsibility for damages of any kind resulting from delays or errors in data transmitted or received using the Sierra Wireless modem, or for failure of the Sierra Wireless modem to transmit or receive such data.

Safety and Hazards

Do not operate the Sierra Wireless modem in areas where cellular modems are not advised without proper device certifications. These areas include environments where cellular radio can interfere such as explosive atmospheres, medical equipment, or any other equipment which may be susceptible to any form of radio interference. The Sierra Wireless modem can transmit signals that could interfere with this equipment. Do not operate the Sierra Wireless modem in any aircraft, whether the aircraft is on the ground or in flight. In aircraft, the Sierra Wireless modem **MUST BE POWERED OFF**. When operating, the Sierra Wireless modem can transmit signals that could interfere with various onboard systems.

Note: Some airlines may permit the use of cellular phones while the aircraft is on the ground and the door is open. Sierra Wireless modems may be used at this time.

The driver or operator of any vehicle should not operate the Sierra Wireless modem while in control of a vehicle. Doing so will detract from the driver or operator's control and operation of that vehicle. In some states and provinces, operating such communications devices while in control of a vehicle is an offence.

Limitations of Liability

This manual is provided "as is". Sierra Wireless makes no warranties of any kind, either expressed or implied, including any implied warranties of merchantability, fitness for a particular purpose, or noninfringement. The recipient of the manual shall endorse all risks arising from its use.

The information in this manual is subject to change without notice and does not represent a commitment on the part of Sierra Wireless. SIERRA WIRELESS AND ITS AFFILIATES SPECIFICALLY DISCLAIM LIABILITY FOR ANY AND ALL DIRECT, INDIRECT, SPECIAL, GENERAL, INCIDENTAL, CONSEQUENTIAL, PUNITIVE OR EXEMPLARY DAMAGES INCLUDING, BUT NOT LIMITED TO, LOSS OF PROFITS OR REVENUE OR ANTICIPATED PROFITS OR REVENUE ARISING OUT OF THE USE OR INABILITY TO USE ANY SIERRA WIRELESS PRODUCT, EVEN IF SIERRA WIRELESS AND/OR ITS AFFILIATES HAS BEEN ADVISED OF THE POSSIBILITY OF SUCH DAMAGES OR THEY ARE FORESEEABLE OR FOR CLAIMS BY ANY THIRD PARTY.

Notwithstanding the foregoing, in no event shall Sierra Wireless and/or its affiliates aggregate liability arising under or in connection with the Sierra Wireless product, regardless of the number of events, occurrences, or claims giving rise to liability, be in excess of the price paid by the purchaser for the Sierra Wireless product.

Customer understands that Sierra Wireless is not providing cellular or GPS (including A-GPS) services. These services are provided by a third party and should be purchased directly by the Customer.

SPECIFIC DISCLAIMERS OF LIABILITY: CUSTOMER RECOGNIZES AND ACKNOWLEDGES SIERRA WIRELESS IS NOT RESPONSIBLE FOR AND SHALL NOT BE HELD LIABLE FOR ANY DEFECT OR DEFICIENCY OF ANY KIND OF CELLULAR OR GPS (INCLUDING A-GPS) SERVICES.

Patents

This product may contain technology developed by or for Sierra Wireless Inc.

This product includes technology licensed from QUALCOMM®.



This product is manufactured or sold by Sierra Wireless Inc. or its affiliates under one or more patents licensed from InterDigital Group and MMP Portfolio Licensing.

Copyright

© 2013 Sierra Wireless. All rights reserved.

Trademarks

AirCard® is a registered trademark of Sierra Wireless. Sierra Wireless™, AirPrime™, AirLink™, AirVantage™, Watcher™ and the Sierra Wireless logo are trademarks of Sierra Wireless.

 ,  , inSIM®, WAVECOM®, WISMO®, Wireless Microprocessor®, Wireless CPU®, Open AT® are filed or registered trademarks of Sierra Wireless S.A. in France and/or in other countries.

Windows® and Windows Vista® are registered trademarks of Microsoft Corporation.

Macintosh and Mac OS are registered trademarks of Apple Inc., registered in the U.S. and other countries.

QUALCOMM® is a registered trademark of QUALCOMM Incorporated. Used under license.

Other trademarks are the property of the respective owners.

Contact Information

Sales Desk:	Phone:	1-604-232-1488
	Hours:	8:00 AM to 5:00 PM Pacific Time
	E-mail:	sales@sierrawireless.com
Post:	Sierra Wireless 13811 Wireless Way Richmond, BC Canada V6V 3A4	
Technical Support:	support@sierrawireless.com	
RMA Support:	repairs@sierrawireless.com	
Fax:	1-604-231-1109	
Web:	www.sierrawireless.com	

Consult our website for up-to-date product descriptions, documentation, application notes, firmware upgrades, troubleshooting tips, and press releases: www.sierrawireless.com

Document History

Version	Date	Updates
1.0	December 12, 2011	Creation
2.0	February 08, 2013	Updated sections: <ul style="list-style-type: none">• 8 Current Consumption Measurement• 9 Reference Documents



Contents

1. OVERVIEW	10
2. GENERAL DESCRIPTION	11
2.1. RoHS Compliance	11
2.2. AirPrime WS Series Development Kit	11
2.2.1. Development Kit Component Placement Diagram	13
2.3. Socket Boards	14
2.3.1. Socket Board Component Placement Diagram	16
2.4. Special Soldering for Jumper Pads	17
2.5. Default Soldering Configuration for Jumpers	18
2.5.1. Development Kit Board	19
2.5.2. Socket Boards	20
2.6. Available Test Ports on the AirPrime WS Series Development Kit	22
3. SETTING UP THE AIRPRIME WS SERIES DEVELOPMENT KIT	26
3.1. Setting Up the AirPrime WS Series Development Kit	26
3.2. Communications Test.....	30
4. INTERFACES/PERIPHERALS ON THE DEVELOPMENT KIT BOARD	31
4.1. Power Supplies.....	31
4.1.1. Main Supply Adapter	32
4.1.2. External Supply	32
4.1.2.1. AUX-ADC1	33
4.1.3. LED Signalization for VBAT	33
4.2. SIM	34
4.2.1. SIM Connector (J406)	34
4.3. UART1	35
4.3.1. UART1 Connector (J100).....	35
4.3.2. UART1 Configuration	36
4.3.3. UART1 Enabling and Signalization	36
4.3.3.1. UART1 LED (D100).....	37
4.3.3.2. RING INDICATOR LED (D101).....	37
4.4. UART2.....	37
4.4.1. UART2 Connector (J200).....	37
4.4.2. UART2 Configuration for WISMO2x8	38
4.4.3. UART2 Configuration for WS6318	38
4.4.4. UART2 Enabling and Signalization	39
4.5. Analog Audio	39
4.5.1. Analog Audio Connector (J700)	39
4.5.2. Selecting a Speaker Channel	40
4.5.3. Analog Audio Connection Mode	41
4.6. Digital Audio Interface (PCM)	43
4.6.1. Digital Audio Connector (J701)	43

4.6.2.	Enabling the Digital Audio (PCM) Function (SW302)	44
4.7.	Flash_LED (LED, D602)	44
4.8.	Buzzer LED (BUZZER, D600)	44
4.9.	JTAG.....	45
4.9.1.	JTAG Connector	45
4.10.	Other Interfaces	46
4.10.1.	Power Supply Function	46
4.10.2.	Backup Battery Function	46
4.10.3.	ADC Function.....	46
4.10.3.1.	AUX-ADC0	46
4.10.3.2.	AUX-ADC1	46
5.	INTERFACES/PERIPHERALS ON THE SOCKET BOARD	47
5.1.	Antenna Function	47
6.	CONTROL FUNCTIONS	48
6.1.	ON/~OFF	48
6.1.1.	WISMO2x8 Socket Board	48
6.1.2.	WS6318 Socket Board.....	48
6.2.	~RESET.....	49
7.	ESD PROTECTIONS.....	50
8.	CURRENT CONSUMPTION MEASUREMENT.....	51
9.	REFERENCE DOCUMENTS.....	54
10.	LIST OF ABBREVIATIONS	55
11.	APPENDIX	56
11.1.	AirPrime WS Series Development Kit	57
11.2.	AirPrime WISMO2x8 Socket Board.....	71
11.3.	AirPrime WS6318 Socket Board	75



List of Figures

Figure 1.	AirPrime WS Series Development Kit, Board Version 1400682-B (Top View)	11
Figure 2.	AirPrime WS Series Development Kit, Board Version 1400682-B (Bottom View).....	12
Figure 3.	AirPrime WS Series Development Kit Board (Top View)	13
Figure 4.	AirPrime WISMO2x8 Socket Board (Top View)	14
Figure 5.	AirPrime WISMO2x8 Socket Board (Bottom View)	14
Figure 6.	AirPrime WS6318 Socket Board (Top View).....	15
Figure 7.	AirPrime WS6318 Socket Board (Bottom View)	15
Figure 8.	AirPrime WISMO2x8 Socket Board (Top View)	16
Figure 9.	AirPrime WS6318 Socket Board (Top View).....	17
Figure 10.	Jumper Solder Pad.....	17
Figure 11.	WS Series Development Kit Default Soldering Configuration for Jumpers, Board Version 1400682-B (Top View)	19
Figure 12.	WISMO2x8 Socket Board Default Soldering Configuration for Jumpers (Top View)	20
Figure 13.	WS6318 Socket Board Default Soldering Configuration for Jumpers (Top View)	21
Figure 14.	Test Ports Available on the AirPrime WS Series Development Kit.....	22
Figure 15.	AirPrime WS Series Development Kit (with a WS6318 Socket Board and Embedded Module)	30
Figure 16.	Power Supply Connectors (J604 and J600).....	31
Figure 17.	VBATT Connection (J605)	31
Figure 18.	Main Supply Adapter	32
Figure 19.	External Power Supply Connector	32
Figure 20.	External Power Supply Pins	32
Figure 21.	LED Signalization of VBAT.....	33
Figure 22.	SIM Interface	34
Figure 23.	UART1 Interface.....	35
Figure 24.	DB-9 Female Connector for UART1.....	35
Figure 25.	RS232 Main Serial Link	36
Figure 26.	UART1 Switch Configuration and LED Location	36
Figure 27.	UART2 Interface.....	37
Figure 28.	DB-9 Female Connector for UART2.....	37
Figure 29.	RS232 Auxiliary Serial Link (4-wire Configuration) with a WISMO2x8 Socket Board	38
Figure 30.	RS232 Auxiliary Serial Link (2-wire Configuration) with a WS6318 Socket Board	38
Figure 31.	UART2 Switch Configuration and LED Location	39
Figure 32.	Analog Audio Interface	39
Figure 33.	RJ9 4-pin Connector for Analog Audio.....	40
Figure 34.	Selecting a Speaker Channel.....	40
Figure 35.	SW710 Configuration with a WISMO2x8 Socket Board	41
Figure 36.	Settings for a Differential Microphone	41

Figure 37.	Settings for a Single-Ended Microphone.....	42
Figure 38.	Settings for a Single-Ended Speaker	42
Figure 39.	Digital Audio Interface (PCM).....	43
Figure 40.	RJ9 4-pin Connector for Digital Audio.....	43
Figure 41.	Digital Audio (PCM) Switch Configuration.....	44
Figure 42.	Flash_LED Location	44
Figure 43.	BUZZER Location	44
Figure 44.	JTAG Connector.....	45
Figure 45.	SMA Connector on the WISMO2x8 Socket Board.....	47
Figure 46.	SMA Connector on the WS6318 Socket Board	47
Figure 47.	AirPrime WISMO2x8 Embedded Module ON/~OFF Switch on the WISMO2x8 Socket Board	48
Figure 48.	AirPrime WS6318 Embedded Module ON/~OFF Switch on the Development Kit Board... ..	48
Figure 49.	~RESET Button	49
Figure 50.	AirPrime WISMO2x8 Socket Board Assembly (Top View)	71
Figure 51.	AirPrime WISMO2x8 Socket Board Assembly (Bottom View)	72
Figure 52.	AirPrime WS6318 Socket Board Component Placement Diagram (Top View)	75



List of Tables

Table 1.	AirPrime WS Series Development Kit Test Ports.....	22
Table 2.	Supported Adapter	32
Table 3.	Electrical Characteristics of VBATT	33
Table 4.	Electrical Characteristics of AUX-ADC1	33
Table 5.	Status of VBATT and VBAT	34
Table 6.	SIM Connector Pin Description	34
Table 7.	UART1 Connector Pin Description.....	35
Table 8.	UART2 Connector (on the Development Kit Board) Pin Description	38
Table 9.	Analog Audio Connector Pin Description	40
Table 10.	Digital Audio (PCM) Connector Pin Description	43
Table 11.	JTAG Connector Pin Description	45



1. Overview

This document describes the AirPrime WS Series Development Kit (board version 1400682-B) and how it integrates with the AirPrime WS Series of Intelligent Embedded Module via a socket board. This document introduces the different interface and peripheral connections supported by the AirPrime WS Series Development Kit, and provides schematics to facilitate the user's understanding and configuration of the development kit board for their own application use.

The AirPrime WS Series Development Kit Board has been designed for customers to develop both software and hardware applications based on the AirPrime WS Series embedded module (WISMO218, WISMO228, and WS6318). Note however that in order to use the development kit with the embedded module, the embedded module must be soldered-down to an appropriate socket board.

For more information about the AirPrime WS Series of embedded modules and the Sierra Wireless Software Suite, refer to the documents listed in section 9 Reference Documents.

2. General Description

This section gives a brief overview of the AirPrime WS Series Development Kit and briefly describes the interfaces and special jumper pads available. It also lists all available test points on the development kit board.

2.1. RoHS Compliance

The AirPrime WS Series Development Kit board is compliant with RoHS (Restriction of Hazardous Substances in Electrical and Electronic Equipment) Directive 2002/95/EC which sets limits for the use of certain restricted hazardous substances. This directive states that “from 1st July 2006, new electrical and electronic equipment put on the market does not contain lead, mercury, cadmium, hexavalent chromium, polybrominated biphenyls (PBB) or polybrominated diphenyl ethers (PBDE)”.

The WS Series embedded module (WISMO218, WISMO228, and WS6318) are also compliant with this directive.



2.2. AirPrime WS Series Development Kit

The AirPrime WS Series Development Kit may be used to create and define applications based on the AirPrime WS Series embedded module.

The development kit version number is printed on the bottom edge of the board.

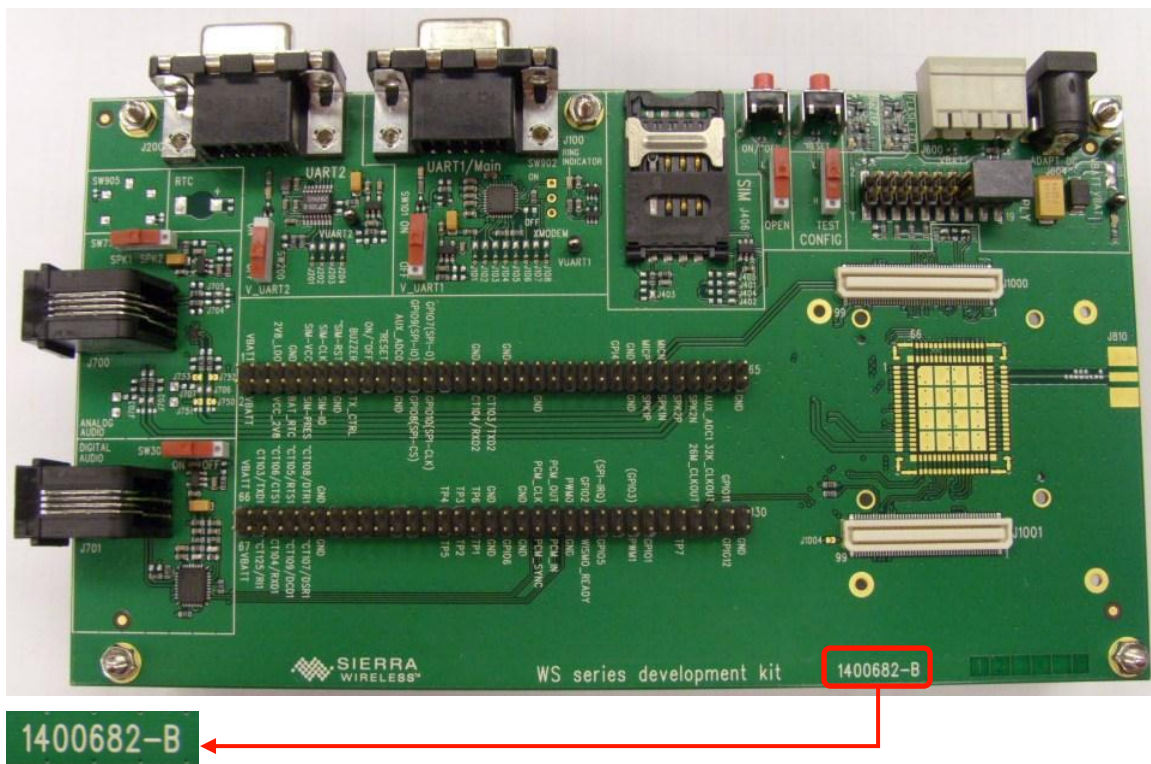

Figure 1. AirPrime WS Series Development Kit, Board Version 1400682-B (Top View)

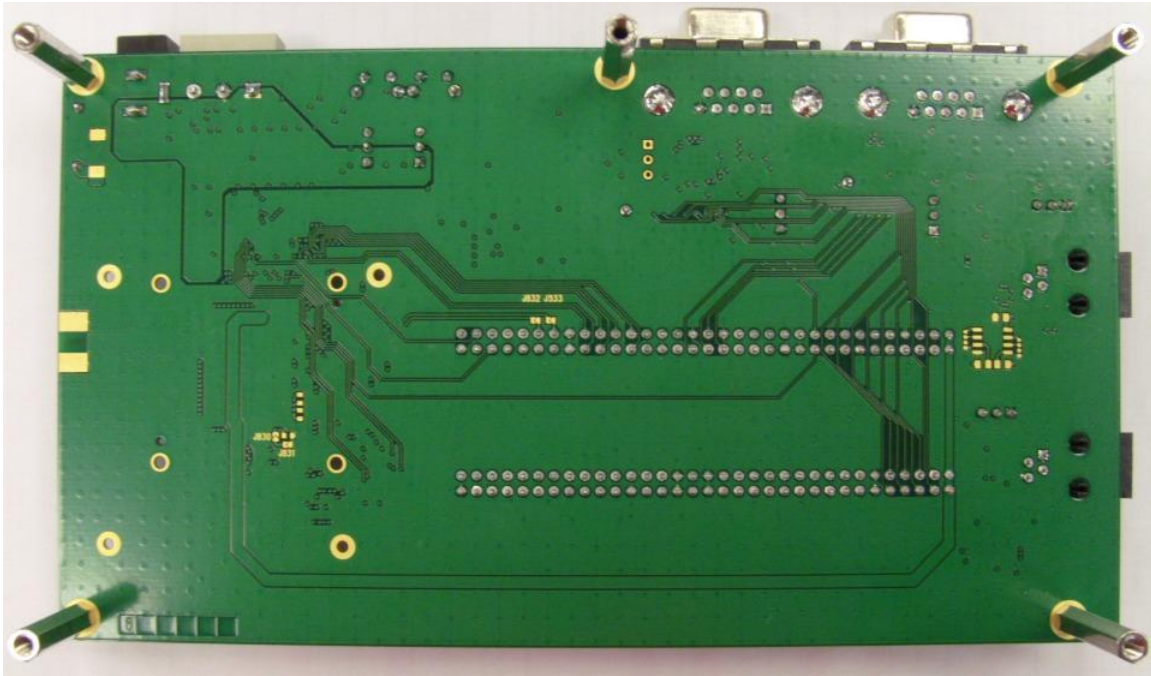

Figure 2. AirPrime WS Series Development Kit, Board Version 1400682-B (Bottom View)

2.2.1. Development Kit Component Placement Diagram

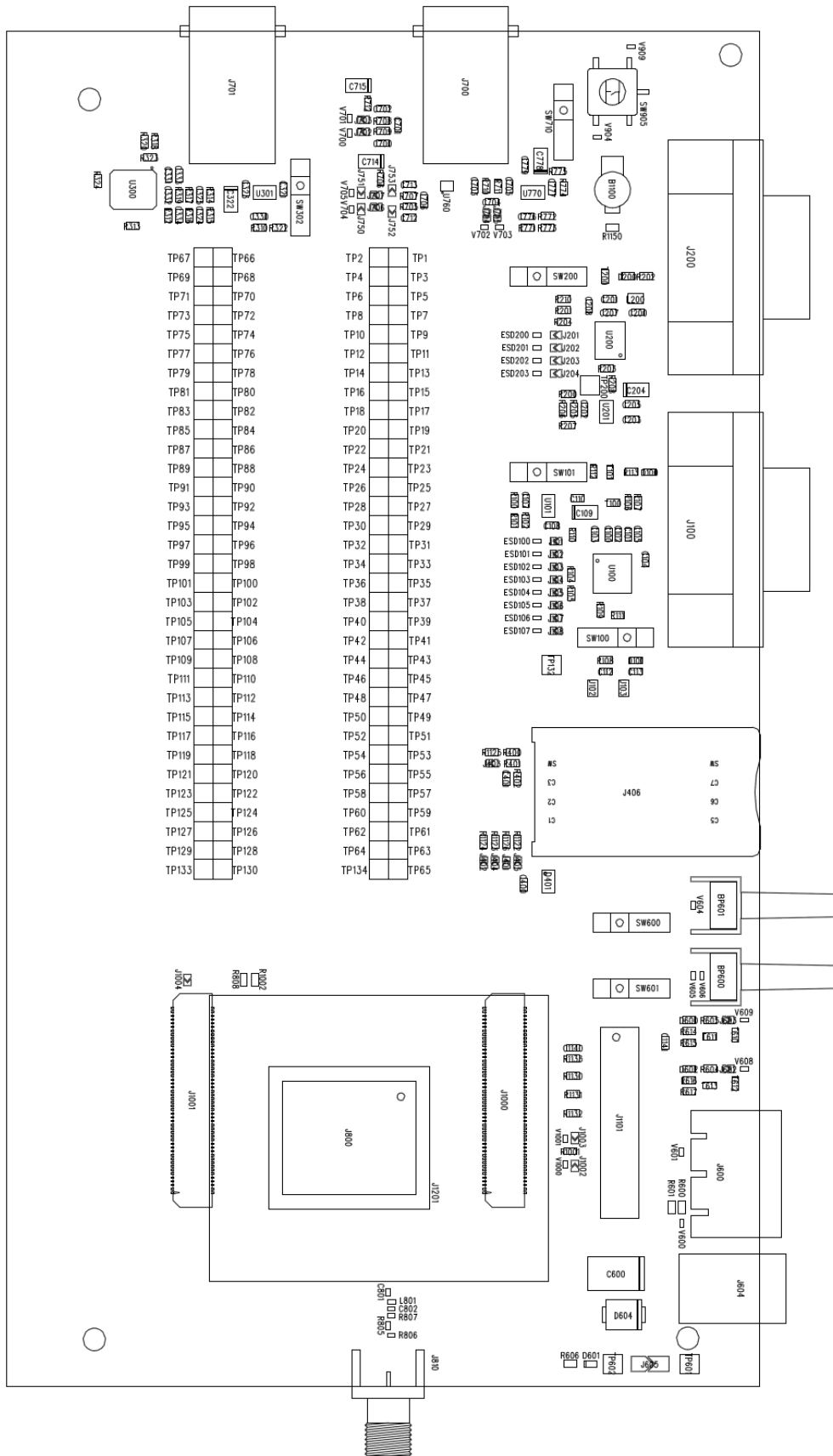

Figure 3. AirPrime WS Series Development Kit Board (Top View)

2.3. Socket Boards

The socket board is used to interface an AirPrime WS Series embedded module with the WS Series Development Kit. It provides a changeable interface for the WS series embedded modules using the same set of peripheral devices; and varies depending on which WS series embedded module is used.

The WS Series Development Kit currently supports two socket boards – the WISMO2x8 socket board, and the WS6318 socket board.

Refer to section 11 Appendix for schematic diagrams of the AirPrime WS Series Development Kit and the supported socket boards.



Figure 4. AirPrime WISMO2x8 Socket Board (Top View)



Figure 5. AirPrime WISMO2x8 Socket Board (Bottom View)

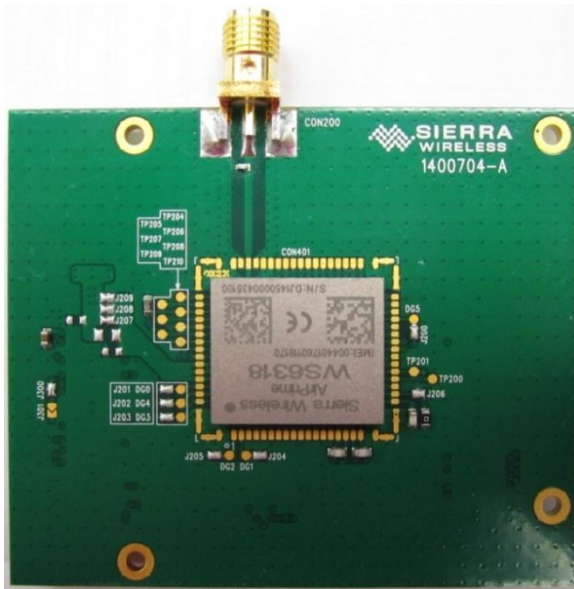

Figure 6. AirPrime WS6318 Socket Board (Top View)

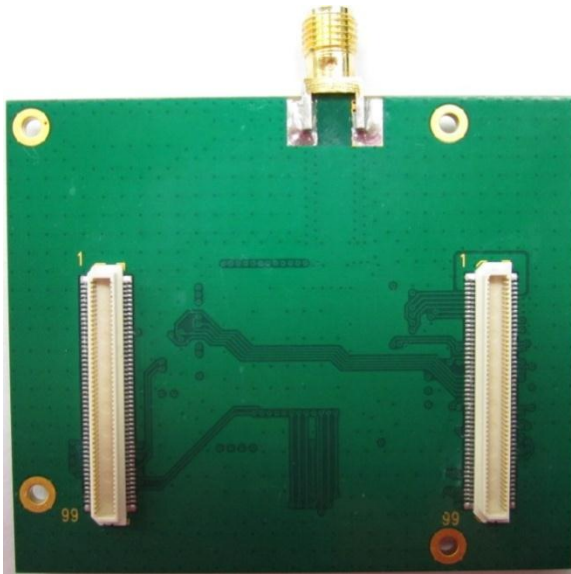

Figure 7. AirPrime WS6318 Socket Board (Bottom View)

2.3.1. Socket Board Component Placement Diagram

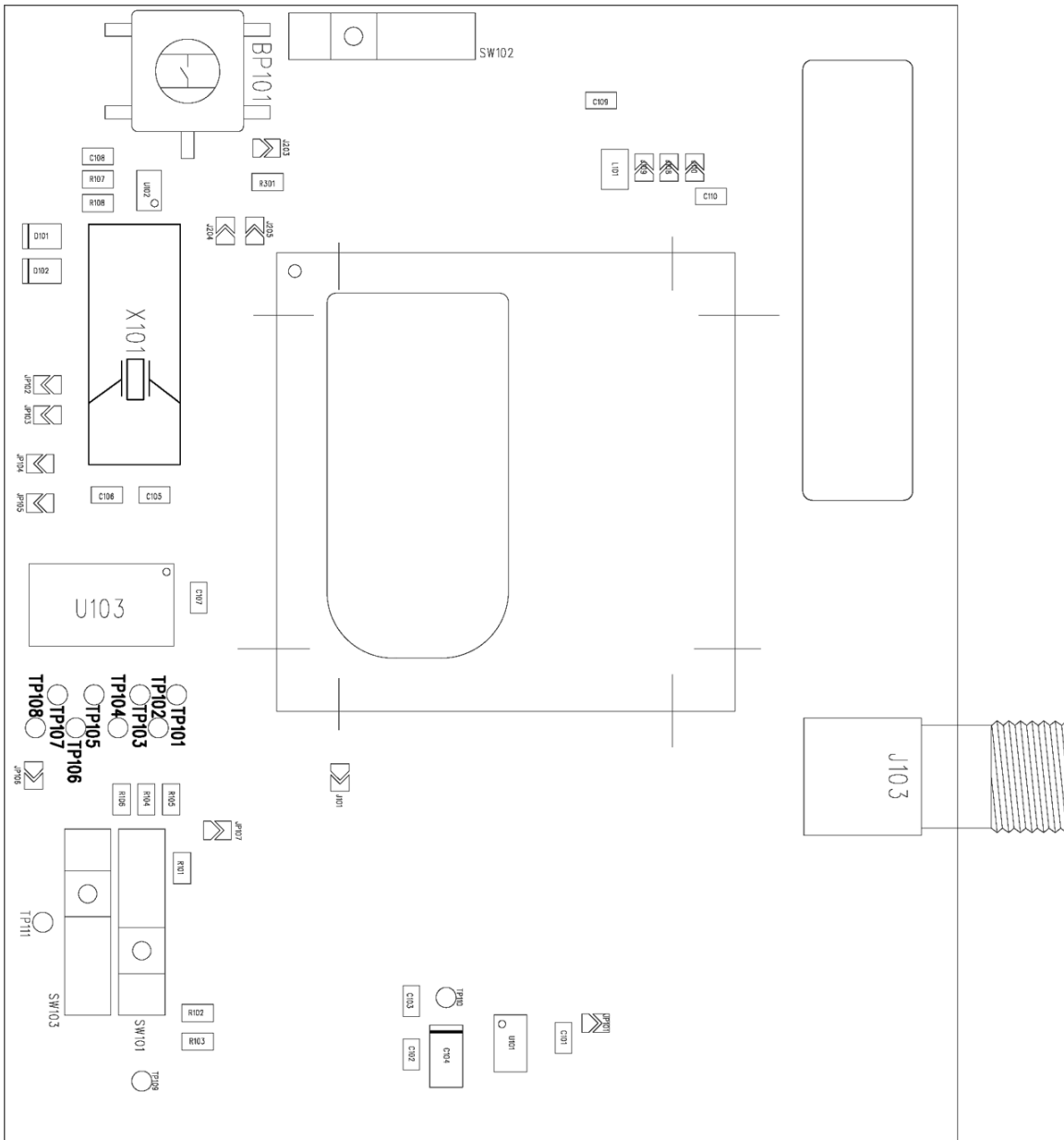

Figure 8. AirPrime WISMO2x8 Socket Board (Top View)

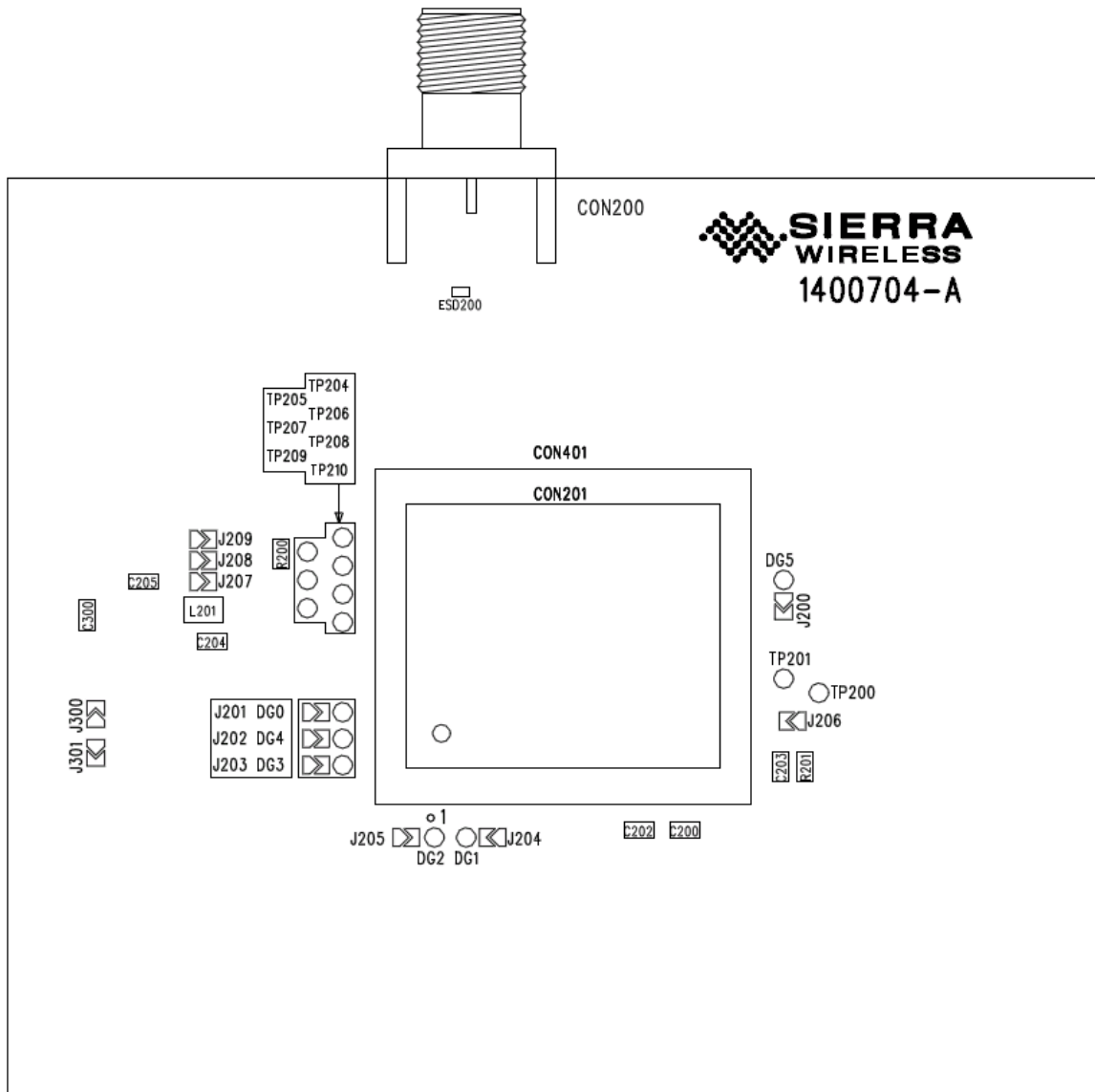

Figure 9. AirPrime WS6318 Socket Board (Top View)

2.4. Special Soldering for Jumper Pads

PCB jumper prints are used to electrically connect or disconnect peripherals between the AirPrime WS series embedded module and the AirPrime WS Series Development Kit.



Figure 10. Jumper Solder Pad

To connect signals between the AirPrime WS series embedded module (from J1000 and J1001) and the dedicated connectors on the AirPrime WS Series Development Kit or Socket Board, solder the PCB jumper prints specified in section 2.5 Default Soldering Configuration for Jumpers.

The interfaces (and signals) listed below could be electrically removed by dissociating the following PCB jumper prints:

- Power supply of the AirPrime WS Series Development Kit interfaces (All components from J605, except for the AirPrime WS Series embedded module. For more information, refer to section 8 Current Consumption Measurement.)
- SIM (from J401 to J405)
- UART1 (from J101 to J108)
- UART2 (from J201 to J204)
- Analog Audio (from J702 to J707)
- Flash LED signal (J602)
- BUZZER signal (J603)

2.5. Default Soldering Configuration for Jumpers

The following sub-sections display the default soldering configuration for jumpers on both the development kit board and on the supported socket boards.

2.5.2. Socket Boards

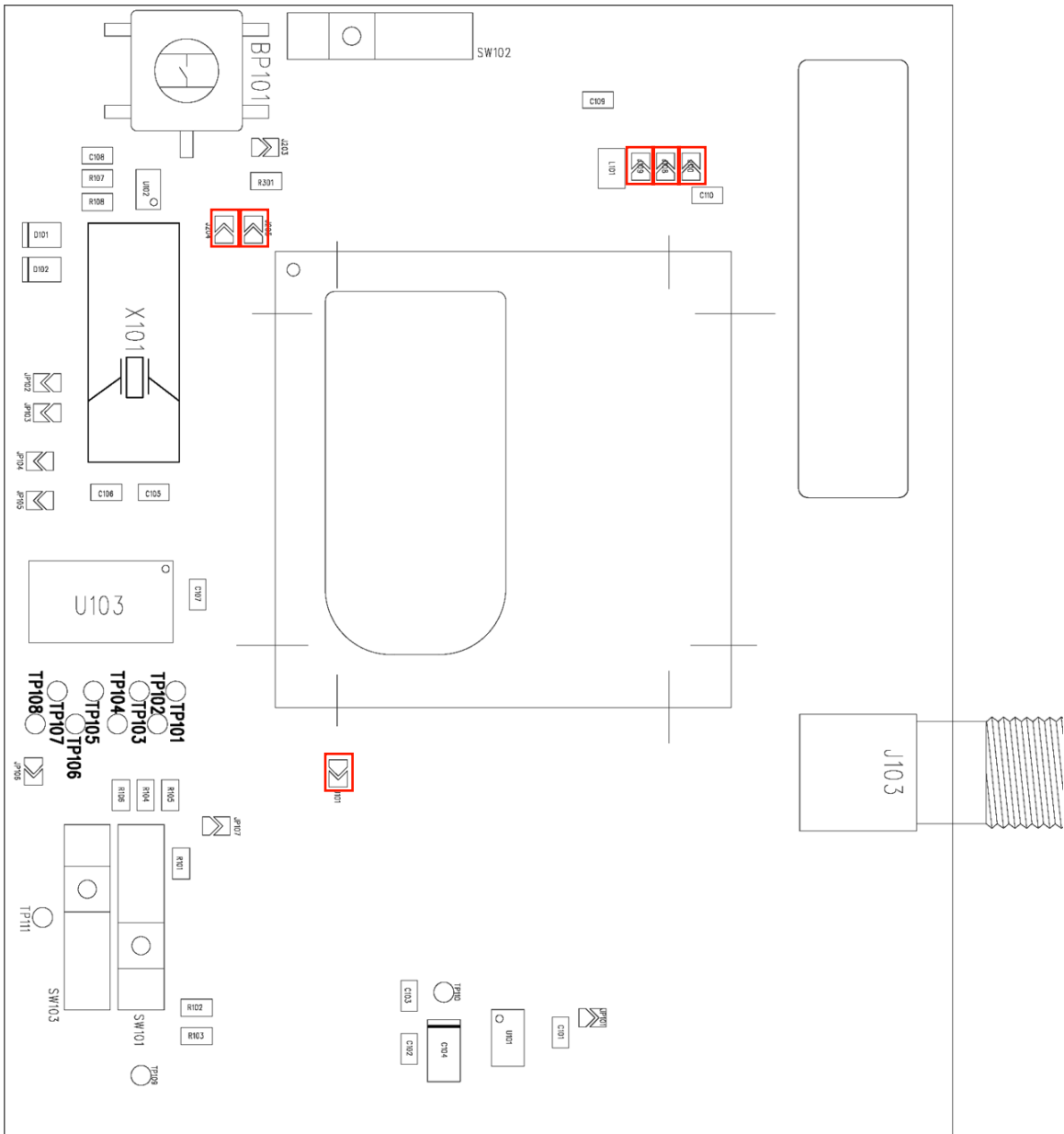

Figure 12. WISMO2x8 Socket Board Default Soldering Configuration for Jumpers (Top View)

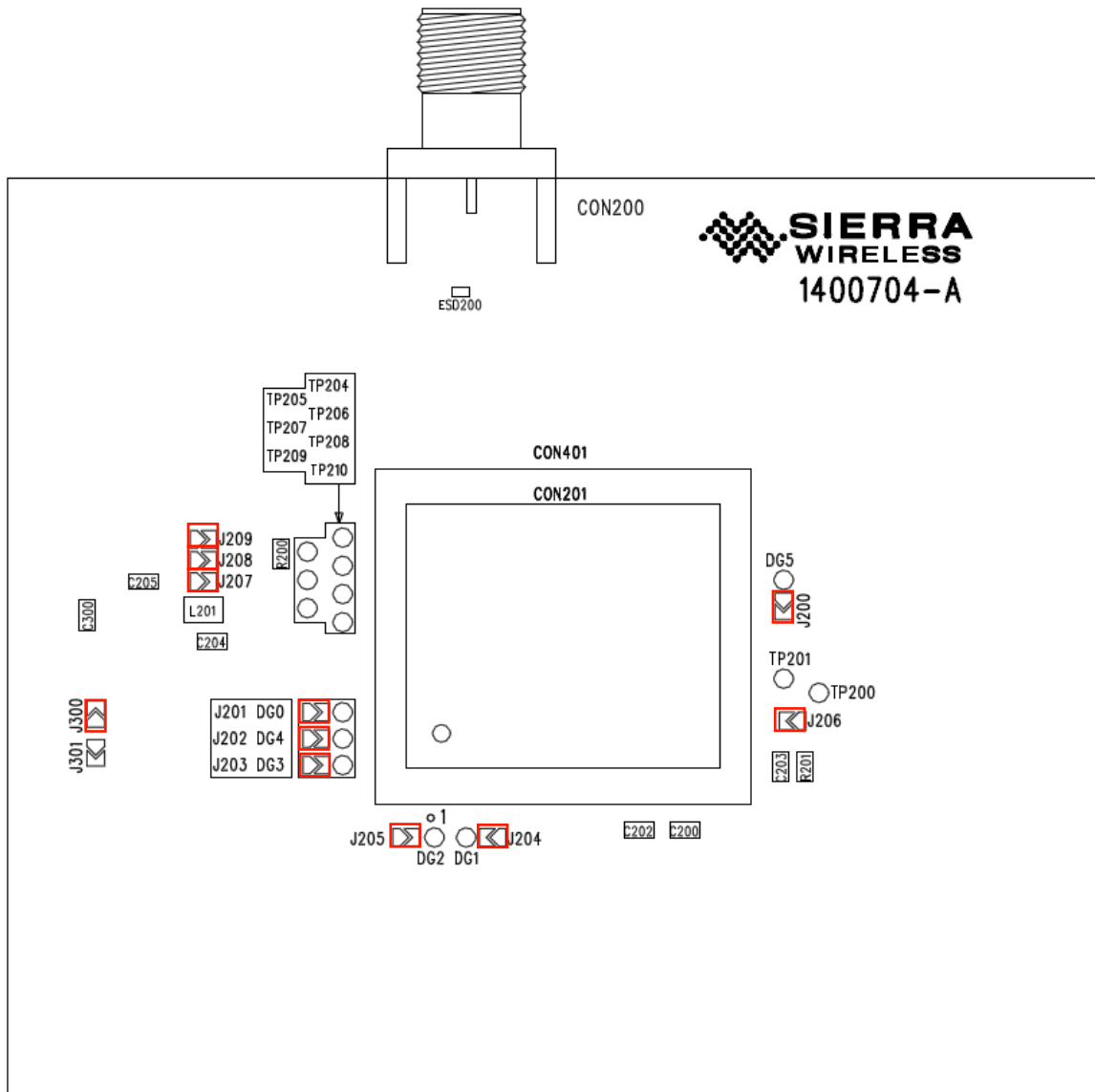

Figure 13. WS6318 Socket Board Default Soldering Configuration for Jumpers (Top View)

2.6. Available Test Ports on the AirPrime WS Series Development Kit

There are a total of 130 test ports available in the AirPrime WS Series Development Kit. The following figure shows the location of these test ports in the AirPrime WS Series Development Kit and the table below lists their corresponding pin assignments.

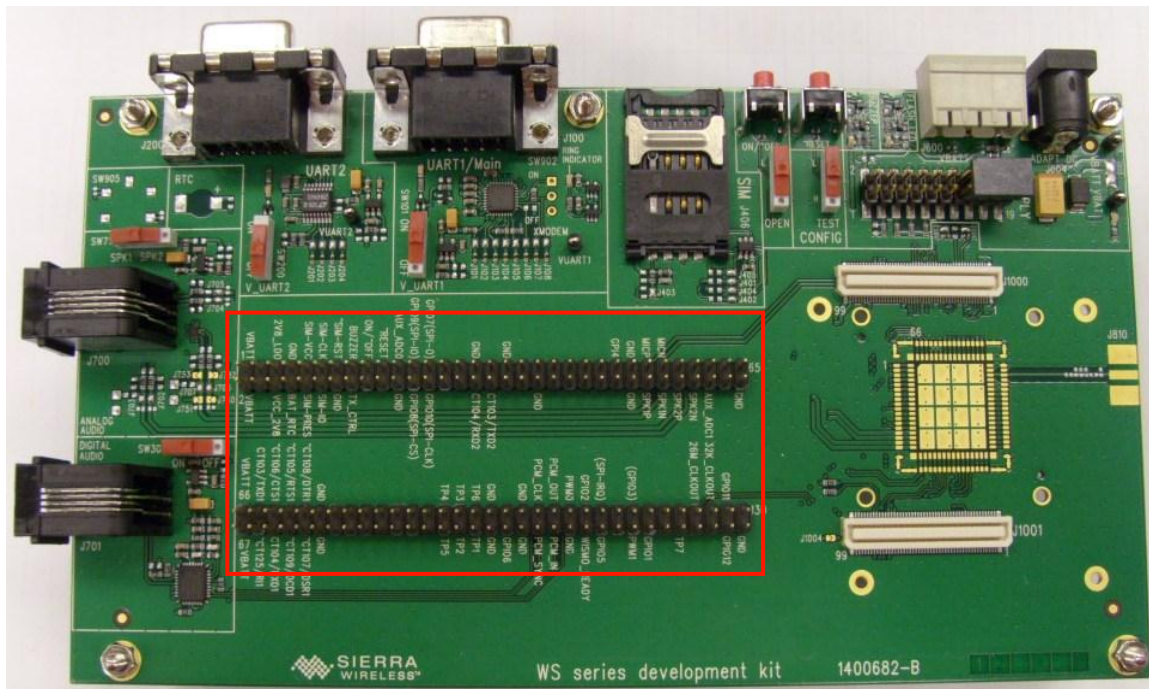

Figure 14. Test Ports Available on the AirPrime WS Series Development Kit

Table 1. AirPrime WS Series Development Kit Test Ports

Test Port	Development Kit Serigraphy	WISMO2x8 Embedded Module Pin	WS6318 Embedded Module Pin
1	VBATT	VBATT	VBATT
2	VBATT	VBATT	VBATT
3	-	N/A	N/A
4	-	N/A	N/A
5	2V8_LDO	N/A	2V8_LDO
6	VCC_2V8	VCC_2V8	VCC_2V8
7	GND	GND	GND
8	BAT_RTC	BAT-RTC	BAT-RTC
9	SIM-VCC	SIM-VCC	SIM-VCC
10	SIM-PRES	N/A	SIM-PRES
11	SIM-CLK	SIM-CLK	SIM-CLK
12	SIM-IO	SIM-IO	SIM-IO
13	~SIM-RST	~SIM-RST	~SIM-RST
14	GND	GND	GND
15	BUZZER	BUZZER	BUZZER
16	TX_CTRL	TX_CTRL	TX_CTRL
17	ON/~OFF	ON/~OFF	ON/~OFF

Test Port	Development Kit Serigraphy	WISMO2x8 Embedded Module Pin	WS6318 Embedded Module Pin
18	-	N/A	N/A
19	~RESET	~RESET	~RESET
20	-	N/A	N/A
21	AUX_ADC0	AUX_ADC0	AUX_ADC0
22	GND	GND	GND
23	GPIO9/(SPI-IO)	SPI-IO	GPIO9
24	GPIO8/(SPI-CS)	~SPI-CS	GPIO8
25	GPIO7/(SPI-O)	SPI-O	GPIO7
26	GPIO10/(SPI-CLK)	SPI-CLK	GPIO10
27	-	N/A	N/A
28	-	N/A	N/A
29	-	N/A	N/A
30	-	N/A	N/A
31	GND	GND	GND
32	CT104/RXD2	N/A	CT104/RXD2
33	-	N/A	N/A
34	CT103/TXD2	N/A	CT103/TXD2
35	GND	GND	GND
36	-	N/A	N/A
37	-	N/A	N/A
38	-	N/A	N/A
39	-	N/A	N/A
40	GND	GND	GND
41	-	N/A	N/A
42	-	N/A	N/A
43	-	N/A	N/A
44	-	N/A	N/A
45	-	N/A	N/A
46	-	N/A	N/A
47	-	N/A	N/A
48	-	N/A	N/A
49	GPI4	N/A	GPI4
50	-	N/A	N/A
51	GND	GND	GND
52	GND	GND	GND
53	MICP	MICP	MICP
54	SPK1P	N/A	SPK1P
55	MICN	MICN	MICN
56	SPK1N	N/A	SPK1N
57	-	N/A	N/A
58	SPK2P	SPKP	SPK2P
59	-	N/A	N/A
60	SPK2N	SPKN	SPK2N

Test Port	Development Kit Serigraphy	WISMO2x8 Embedded Module Pin	WS6318 Embedded Module Pin
61	-	N/A	N/A
62	AUX_ADC1	N/A	AUX_ADC1
63	-	N/A	N/A
64	-	N/A	N/A
65	-	N/A	N/A
66	VBATT	VBATT	VBATT
67	VBATT	VBATT	VBATT
68	CT103/TXD1	CT103/TXD	CT103/TXD1
69	~CT125/RI1	~CT125/RI	~CT125/RI1
70	~CT106/CTS1	~CT106/CTS	~CT106/CTS1
71	CT104/RXD1	CT104/RXD	CT104/RXD1
72	~CT105/RTS1	~CT105/RTS	~CT105/RTS1
73	~CT109/DCD1	~CT109/DCD	~CT109/DCD1
74	~CT108/DTR1	~CT108/DTR	~CT108/DTR1
75	~CT107/DSR1	~CT107/DSR	~CT107/DSR1
76	GND	GND	GND
77	GND	GND	GND
78	-	N/A	N/A
79	-	N/A	N/A
80	-	N/A	N/A
81	-	N/A	N/A
82	-	N/A	N/A
83	-	N/A	N/A
84	-	N/A	N/A
85	-	N/A	N/A
86	-	N/A	N/A
87	-	N/A	N/A
88	-	N/A	N/A
89	-	N/A	N/A
90	-	N/A	N/A
91	-	N/A	N/A
92	TP4	N/A	TP4
93	TP5	N/A	TP5
94	TP3	N/A	TP3
95	TP2	N/A	TP2
96	TP6	N/A	TP6
97	TP1	N/A	TP1
98	GND	GND	GND
99	GND	GND	GND
100	-	N/A	N/A
101	GPIO6	N/A	GPIO6
102	GND	GND	GND
103	GND	GND	GND

Test Port	Development Kit Serigraphy	WISMO2x8 Embedded Module Pin	WS6318 Embedded Module Pin
104	PCM_CLK	N/A	PCM_CLK
105	PCM_SYNC	N/A	PCM_SYNC
106	PCM_OUT	N/A	PCM_OUT
107	PCM_IN	N/A	PCM_IN
108	PWM0	PWM0	PWM0
109	GND	GND	GND
110	GPIO2	N/A	GPIO2
111	WISMO_READY	WISMO_READY	WISMO_READY
112	(SPI-IRQ)	SPI-IRQ	N/A
113	GPIO5	GPIO5	GPIO5
114	-	TX_CTRL	N/A
115	-	N/A	N/A
116	(GPIO3)	GPIO3	N/A
117	PWM1	PWM1	PWM1
118	-	N/A	N/A
119	GPIO1	GPIO1	GPIO1
120	-	N/A	N/A
121	-	N/A	N/A
122	-	N/A	N/A
123	TP7	N/A	TP7
124	26M_CLKOUT	N/A	26M_CLKOUT
125	-	N/A	N/A
126	32K_CLKOUT	N/A	32K_CLKOUT
127	-	N/A	N/A
128	GPIO11	N/A	GPIO11
129	GPIO12	N/A	GPIO12
130	GND	N/A	GND



3. Setting Up the AirPrime WS Series Development Kit

The following section describes how the AirPrime WS Series Development Kit and the Socket Board (with the AirPrime WS Series embedded module soldered-down) are setup. It also briefly describes how communication tests are done to ensure that the AirPrime WS Series Embedded Module has been properly connected to the AirPrime WS Series Development Kit.

3.1. Setting Up the AirPrime WS Series Development Kit

Prepare the AirPrime WS Series Development Kit (and the socket board) by following these instructions step by step.

1. If using a WISMO2x8 socket board, ensure that switch SW102 on the socket board is set to the “OFF” position.



2. Plug the Socket Board onto the AirPrime WS Series Development Kit using board to board connectors J1000 and J1001.

WISMO2x8 Socket Board:



WS6318 Socket Board:

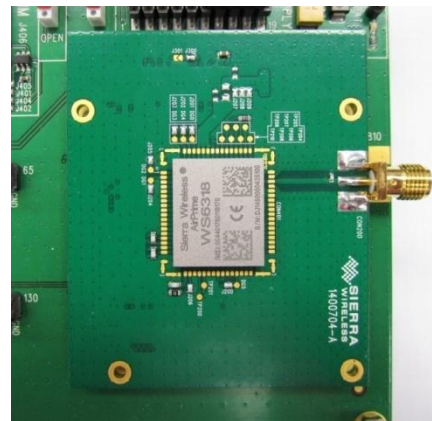

3. Insert a SIM card into the SIM card holder, J400 (if communications is required).

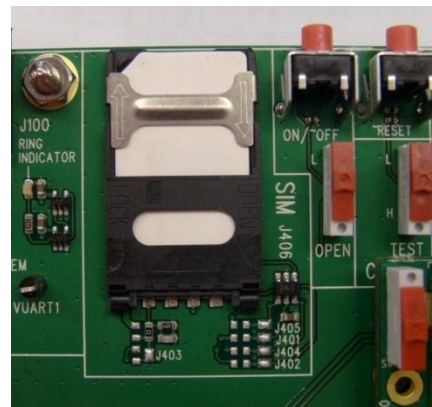

Note: Note that all jumper pads are soldered by default. (Refer to section 2.5 Default Soldering Configuration for Jumpers for more information.) Retain these settings.

4. Connect the RS232 cable between the PC port and J100 of the AirPrime WS Series Development Kit and make sure that SW101 is in the “ON” position.

Note: By default, baud rate = 115200 kbps, data bits = 8, parity = none, and stop bits = 1.

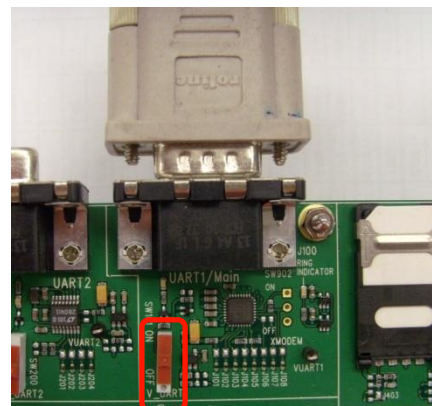

5. If using UART2 for debug purposes, connect an RS232 cable between the PC port and J200 of the AirPrime WS Series Development Kit.



6. If RF communications is required, connect the SMA connector on the Socket Board to an external antenna or a Radio Communication Tester using a coaxial cable.



7. If analog audio communications is required, connect the handset to the analog audio connector, J700.
 - If using a WISMO2x8 socket board, ensure that switch SW710 is set to the “SPK2” position.
 - If using a WS6318 Socket Board, select SPK1 or SPK2 by switching SW710 to the correct speaker option.

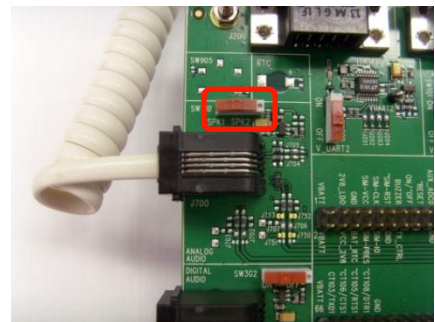

8. If digital audio is needed, connect the audio peripheral to the digital audio connector, J701, and make sure that SW302 is in the “ON” position.

Note: This interface is not available with the WISMO2x8 socket board.

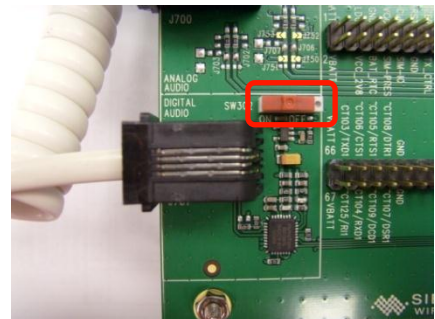

9. Plug in the AC/DC power supply provided in the J604 connector; or connect it to an external DC power supply at 4V/2A (J600).

The presence of a DC power supply is indicated by a green LED, D601. For more details about this LED, refer to section 4.1.3 LED Signalization for VBAT.

Note: The AirPrime WS Series Development Kit is automatically switched ON when power is supplied.

10. Switch the WS series embedded module ON.
 - If using a WISMO2x8 socket board:
 - Press BP101 on the WISMO2x8 socket board to switch the AirPrime WISMO2x8 embedded module ON.
 - If using a WS6318 Socket Board:
 - Make sure the ON/~OFF switch is in the “L” position to switch the AirPrime WS6318 embedded module ON.
 - Alternatively, you can push the ON/~OFF button when the ON/~OFF switch is in the “OPEN” position to switch the embedded module ON.

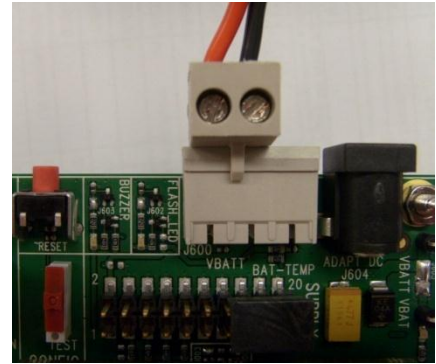

WISMO2x8 Socket Board:



WS6318 Socket Board:

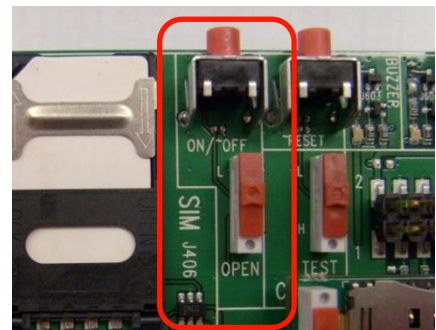

The AirPrime WS Series Development Kit should look like the following figure after it has been properly setup.

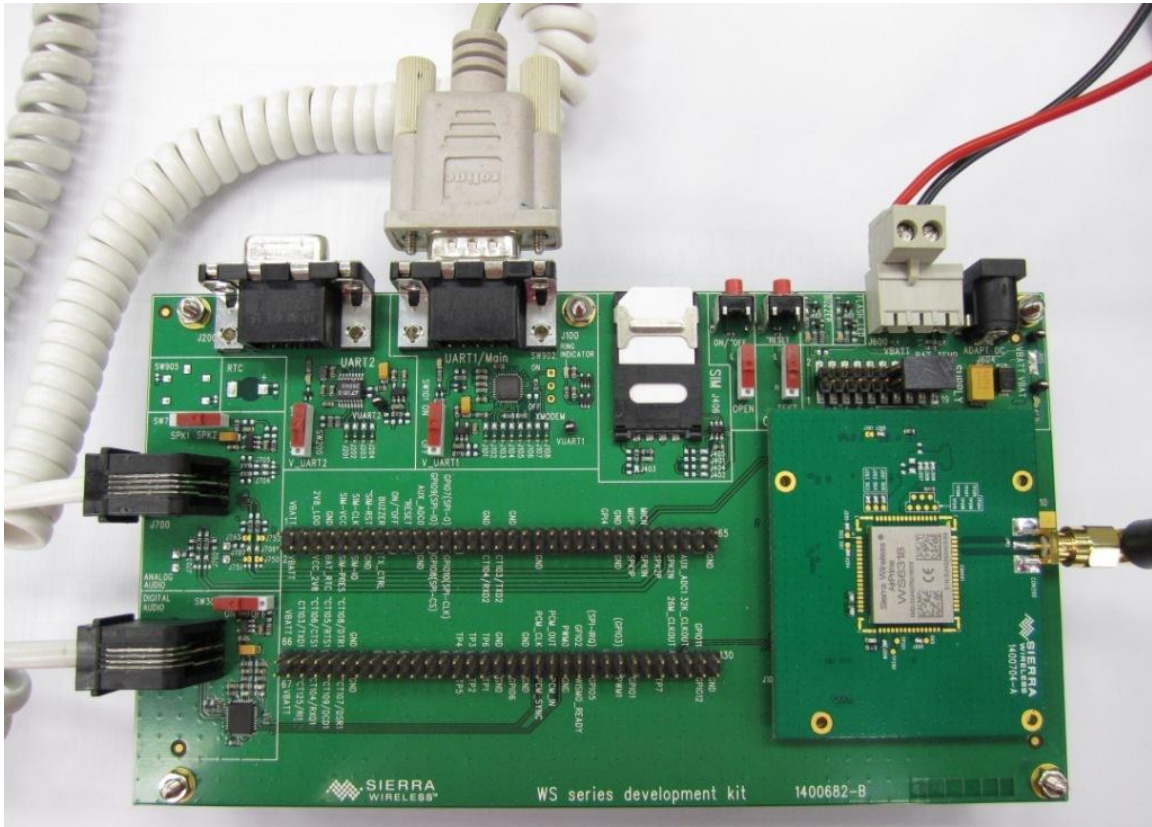

Figure 15. AirPrime WS Series Development Kit (with a WS6318 Socket Board and Embedded Module)

3.2. Communications Test

To perform a communications test after setting the AirPrime WS Series Development Kit with the AirPrime WS Series embedded module, do the following:

1. Using a PC terminal emulator, send the following command on a serial port to communicate with the AirPrime WS Series embedded module:

AT↵

2. When communications is established between the PC and the AirPrime WS Series embedded module, the embedded module replies with an “OK”. Verify that the response is displayed in the terminal emulator window.
3. A communication call can be made from the embedded module by AT command, “**ATD12345;**” while the embedded module is connected to the CMU200. Conversely, “RING” will be indicated in the HyperTerminal window on the PC when a call is received by the embedded module; type “**ATA**” to accept the call. For more details about communication calls, please refer to documents [4] AirPrime WS Series Firmware L23b AT Command Manual and [5] AirPrime WS6318 Firmware L31 AT Command Manual.



4. Interfaces/Peripherals on the Development Kit Board

This section describes the different interfaces/peripherals that are available on the AirPrime WS Series Development Kit.

4.1. Power Supplies

Two power supply sources are available on the AirPrime WS Series Development Kit:

- DC external supply (via J600)
- AC/DC adapter (via J604)

These power supplies are protected against electrostatic discharge (ESDs) and voltage or current transient surges by ESD diodes or varistors.

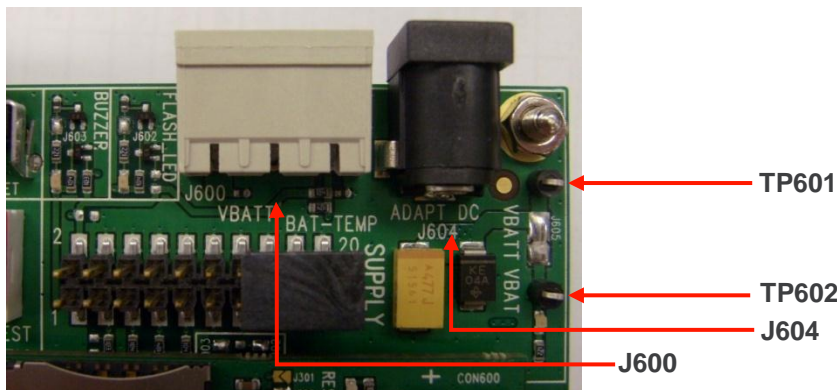

Figure 16. Power Supply Connectors (J604 and J600)

Either one these power supplies can be used for **both** the AirPrime WS Series embedded module and the peripherals on the AirPrime WS Series Development Kit.

Note that it is possible to separate the power supply for the Socket Board (“VBATT” via TP601) and the power supply for the peripherals on the development kit board (“VBAT” via TP602) by unsoldering J605. Current measurement is therefore possible for the AirPrime WS Series Development Kit and for the AirPrime WS Series embedded module. Refer to section 8 Current Consumption Measurement for more information.



Figure 17. VBATT Connection (J605)

4.1.1. Main Supply Adapter

The J604 connector powers the AirPrime WS Series Development Kit using an AC/DC power supply cable.



Figure 18. Main Supply Adapter

Details of the only supported adapter are listed in the following table.

Table 2. Supported Adapter

Manufacturer	Reference	Characteristics
SINPRO	SPU12C-101	4V DC / 2.5A

4.1.2. External Supply

The external supply is accessible through the J600 connector.

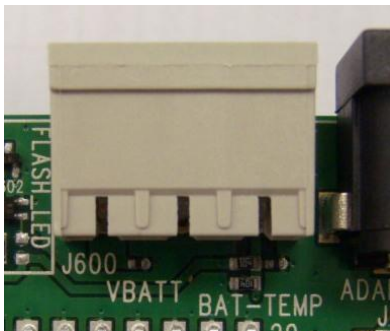

Figure 19. External Power Supply Connector

The J600 connector has three pins:

- **Pins 1-2** are used to plug the power supply.
- **Pins 2-3** are used to plug in AUX-ADC1. (Refer to section 4.1.2.1 AUX-ADC1 for more information.)

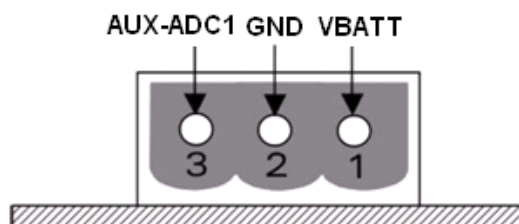

Figure 20. External Power Supply Pins

Refer to the following table for the electrical characteristics of VBATT.

Table 3. Electrical Characteristics of VBATT

	V _{MIN}	V _{NOM}	V _{MAX}
VBATT ^{1,2}	3.2V	3.6V	4.8V

1: This value has to be guaranteed during the burst (with 1.5A Peak for the WISMO2x8 embedded module, and 1.4A Peak for the WS6318 embedded module in GSM or GPRS mode).

2: Maximum operating Voltage Stationary Wave Ratio (VSWR) is 2:1 for the WISMO2x8 embedded module, and 1.5:1 for the WS6318 embedded module.

For more information, refer to the Product Technical Specification and Customer Design Guideline of the corresponding AirPrime WS Series embedded module.

4.1.2.1. AUX-ADC1

The AUX-ADC1 signal is an input (ADC) to the AirPrime WS Series embedded module.

Pins 2-3 of J600 allow the simulation of the temperature level from a sensor inside the battery. Refer to the following table for the electrical characteristics of AUX-ADC1.

Table 4. Electrical Characteristics of AUX-ADC1

	V _{MIN}	V _{NOM}	V _{MAX} *
AUX-ADC1	0	-	1V
	0	-	3V

* AUX-ADC1 may be configured to support a V_{MAX} of either 1V or 3V.

For more information, refer to the Product Technical Specification and Customer Design Guideline of the corresponding AirPrime WS Series embedded module.

4.1.3. LED Signalization for VBAT

The “VBAT” indicator is a green LED and it indicates the presence of a power supply at J600 or J604. Both the AirPrime WS Series embedded module and its peripherals are powered by this power source when J605 is soldered. If J605 is unsoldered, an extra external power supply should be connected to “VBAT” for the AirPrime WS Series Development Kit.

Tip: *It is recommended to always use both VBATT and VBAT simultaneously.*

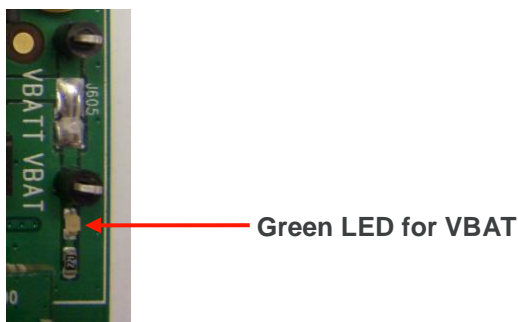

Figure 21. LED Signalization of VBAT

Refer to the following table for the VBATT and VBAT status depending on the LED state.

Note: VBATT is used as a power supply for the Socket Board, while VBAT is used as a power supply for the peripherals on the development kit board.

Table 5. Status of VBATT and VBAT

LED State	VBATT Status	VBAT Status
ON	ON	ON
OFF	ON when J605 is soldered; OFF when J605 is un-soldered	OFF

4.2. SIM

SIM is available on the AirPrime WS Series Development Kit on its dedicated connector, J406, with J401 to J405 soldered.

Note: ESD protection is available on all SIM signals.

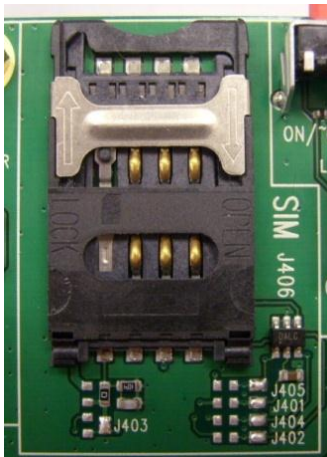

Figure 22. SIM Interface

4.2.1. SIM Connector (J406)

J406 is a standard 1V8 or 3V SIM socket.

Refer to the following table for the SIM connector pin description.

Table 6. SIM Connector Pin Description

Pin Number	Signal Name	I/O	I/O Type	Description
1	SIM-VCC	O	1V8 or 2V9	SIM Power Supply
2	SIM-RST	O	1V8 or 2V9	SIM Reset
3	SIM-CLK	O	1V8 or 2V9	SIM Clock
4	SIMPRES	I	2V8 max*	SIM Card Detect
5	GND			Ground
6	VPP	Not used		
7	SIM-IO	I/O	1V8 or 2V9	SIM Data

Pin Number	Signal Name	I/O	I/O Type	Description
8	CC8		2V8	SIMPRES signal supply

* For either 1V8 or 3V SIM cards.

4.3. UART1

UART1 of the AirPrime WS Series Development Kit is connected to the RS232 serial link interface of the AirPrime WS Series embedded module. The voltage level of UART1 is 2.8V from the AirPrime WS Series Development Kit side.

By default, UART1 is available on its dedicator connector, J100, with J101 to J108 soldered.

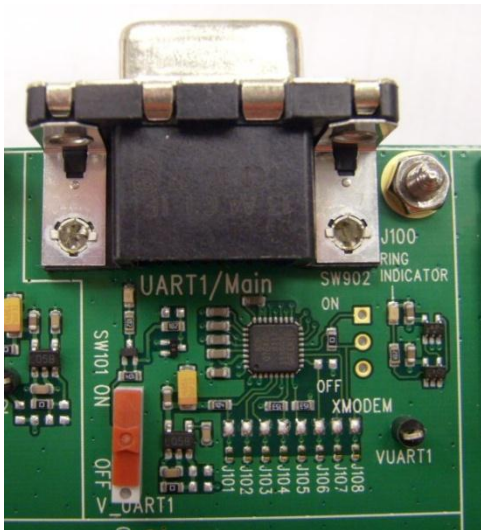

Figure 23. UART1 Interface

4.3.1. UART1 Connector (J100)

J100 is a SUB-D 9-pin female connector.

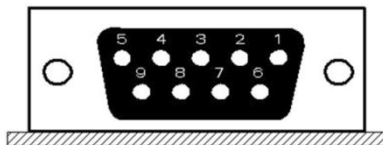

Figure 24. DB-9 Female Connector for UART1

Refer to the following table for the UART1 connector signal pin description.

Table 7. UART1 Connector Pin Description

Pin Number	Signal Name	I/O	I/O Type	Description
1	CT109 DCD	O	RS232 (V24/V28)	Data Carrier Detect
2	CT104 RXD	O	RS232 (V24/V28)	Receive Serial Data
3	CT103 TXD	I	RS232 (V24/V28)	Transmit Serial Data
4	CT108-2 DTR	I	RS232 (V24/V28)	Data Terminal Ready
5	GND			Ground

Pin Number	Signal Name	I/O	I/O Type	Description
6	CT107 DSR	O	RS232 (V24/V28)	Data Set Ready
7	CT105 RTS	I	RS232 (V24/V28)	Request To Send
8	CT106 CTS	O	RS232 (V24/V28)	Clear To Send
9	CT125 RI	O	RS232 (V24/V28)	Ring Indicator

4.3.2. UART1 Configuration

The AirPrime WS Series Development Kit acts as a DCE and is connected to a DTE (PC or terminal) with a “straight cable”. This is a full UART.

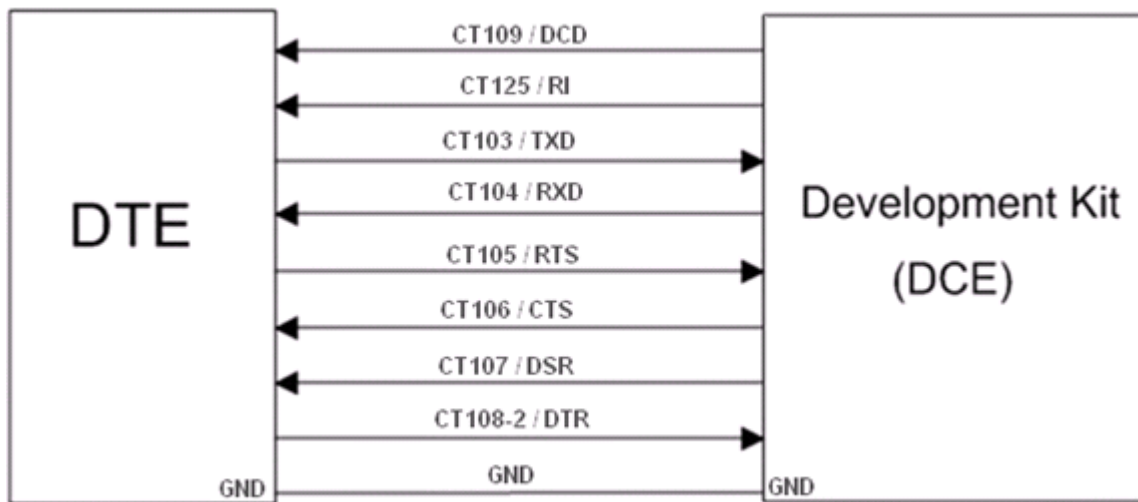

Figure 25. RS232 Main Serial Link

4.3.3. UART1 Enabling and Signalization

The UART1 interface can be enabled by switching SW101 to the “ON” position; and its state is indicated by two LEDs, D100 and D101.

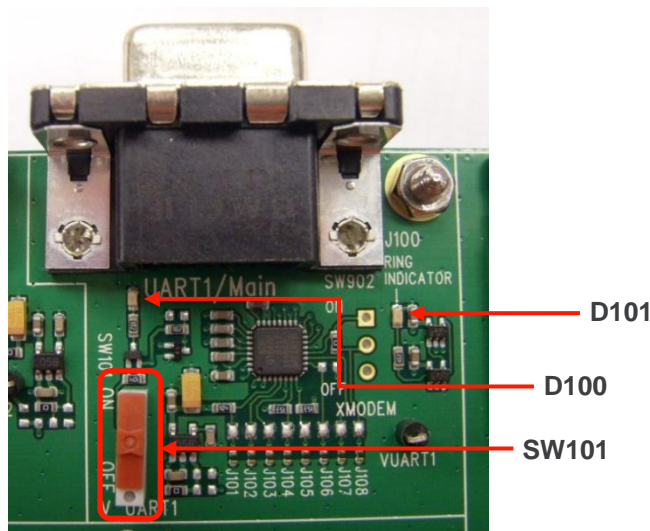

Figure 26. UART1 Switch Configuration and LED Location

4.3.3.1. UART1 LED (D100)

This green LED indicates the power supply state of UART1.

The interface can be used when it is lit depending on which power supply is present (J600 or J604). Refer to section 4.1 Power Supplies for more information.

4.3.3.2. RING INDICATOR LED (D101)

The “RING INDICATOR” is an orange LED controlled by the RI signal on the AirPrime WS Series embedded module.

When the AirPrime WS Series embedded module receives an incoming call, the RI signal goes from high to low for 0.5sec alternately; hence making the LED, D101, blink.

4.4. UART2

The UART2 interface available on the AirPrime WS Series Development Kit is used for debug purposes only.

When used with a WISMO2x8 socket board, the UART2 interfaces with the SPI interface of the AirPrime WISMO2x8 embedded module and performs SPI-to-serial conversion on data characters; and uses four signals.

When used with a WS6318 socket board, the UART2 connects to the auxiliary RS232 serial link interface of the AirPrime WS6318 embedded module at voltage level 2.8V; and uses only two signals.

By default, UART2 is available on its dedicator connector, J200, with J201 to J204 soldered.

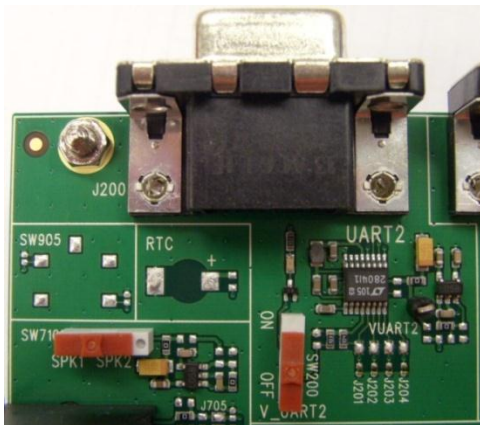

Figure 27. UART2 Interface

4.4.1. UART2 Connector (J200)

J200 is a SUB-D 9-pin female connector.

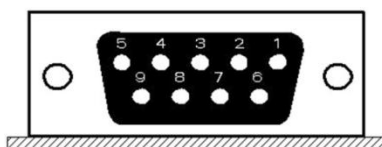

Figure 28. DB-9 Female Connector for UART2

Refer to the following table for the UART2 connector signal pin description.

Table 8. UART2 Connector (on the Development Kit Board) Pin Description

Pin Number	Signal Name	I/O	I/O Type	Description
1	Not used	-	-	-
2	CT104 RXD	O	RS232 (V24/V28)	Receive Serial Data
3	CT103 TXD	I	RS232 (V24/V28)	Transmit Serial Data
4	Not used	-	-	-
5	GND			Ground
6	Not used	-	-	-
7	CT105 RTS*	I	RS232 (V24/V28)	Request To Send
8	CT106 CTS*	O	RS232 (V24/V28)	Clear To Send
9	Not used	-	-	-

* This signal is not used with a WS6318 socket board.

4.4.2. UART2 Configuration for WISMO2x8

The AirPrime WS Series Development Kit acts as a DCE and is connected to a DTE (PC or terminal) with a “straight cable”. Only 4 signals on the UART2 are used as shown in the figure below.

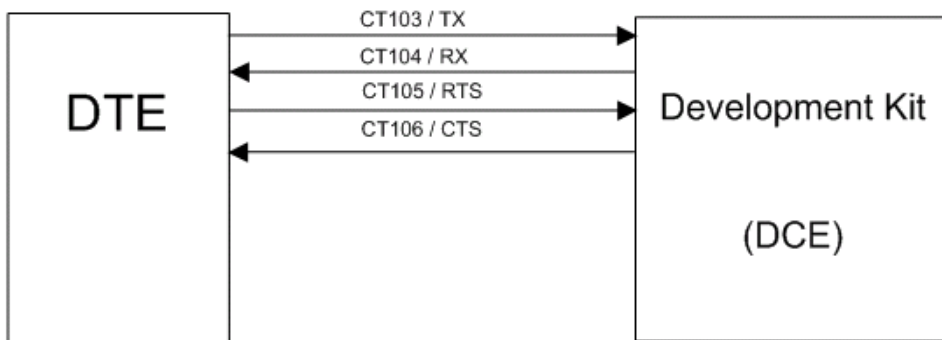

Figure 29. RS232 Auxiliary Serial Link (4-wire Configuration) with a WISMO2x8 Socket Board

4.4.3. UART2 Configuration for WS6318

The AirPrime WS Series Development Kit acts as a DCE and is connected to a DTE (PC or terminal) with a “straight cable”. Only 2 signals on the UART2 are used as shown in the figure below.

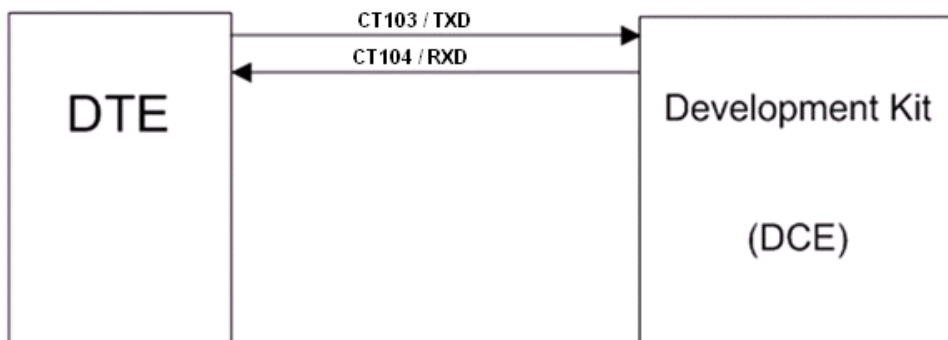

Figure 30. RS232 Auxiliary Serial Link (2-wire Configuration) with a WS6318 Socket Board

4.4.4. UART2 Enabling and Signalization

The UART2 interface can be enabled by switching SW200 to the “ON” position; and its state is indicated by an LED, D200. When this LED is lit, it indicates that the UART2 interface is available for use.

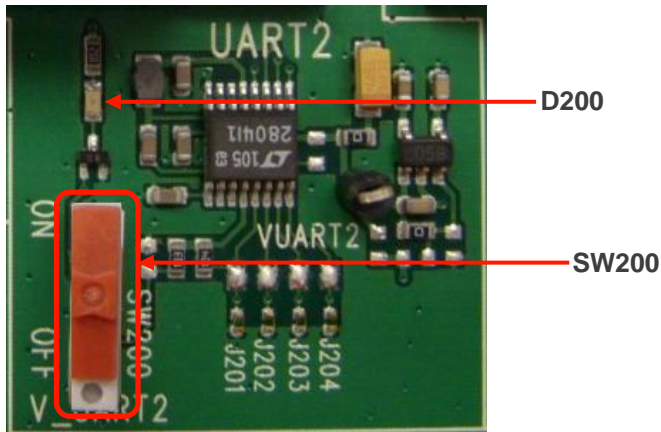

Figure 31. UART2 Switch Configuration and LED Location

4.5. Analog Audio

The analog audio interface on the AirPrime WS Series Development Kit allows connectivity with analog audio devices. For more information about the analog audio interface, refer to the Product Technical Specification and Customer Design Guideline of the corresponding AirPrime WS Series embedded module.

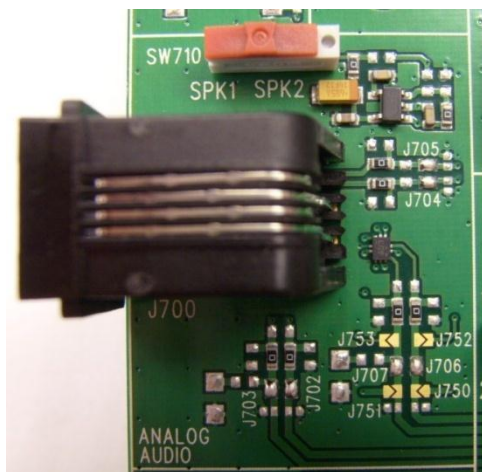

Figure 32. Analog Audio Interface

4.5.1. Analog Audio Connector (J700)

The audio connector could be disconnected from the AirPrime WS Series embedded module when soldering pads J702 to J707 are dissociated.

By default, audio signals of the AirPrime WS Series embedded module are available on its dedicated connector J700 (Analog Audio) when J702 to J707 are soldered.

J700 is an RJ9 4-pin connector.

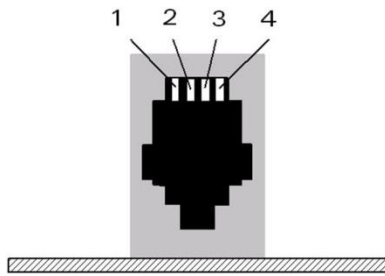

Figure 33. RJ9 4-pin Connector for Analog Audio

Refer to the following table for the analog audio connector signal pin description.

Table 9. Analog Audio Connector Pin Description

Pin Number	Signal Name	I/O	I/O Type	Description
1	MICN	I	Analog	Microphone negative input
2	SPKxN	O	Analog	Speaker negative output
3	SPKxP	O	Analog	Speaker positive output
4	MICP	I	Analog	Microphone positive input

4.5.2. Selecting a Speaker Channel

Although there are two speaker channels available on the WS6318 embedded module, only one analog audio connector is available on the WS Series Development Kit board. Select a speaker channel to use by switching SW710 between SPK1 and SPK2.

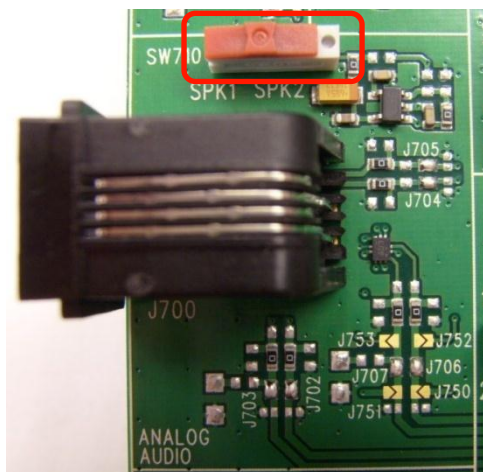

Figure 34. Selecting a Speaker Channel

When using a WISMO2x8 socket board, this switch should always be in the “SPK2” position.

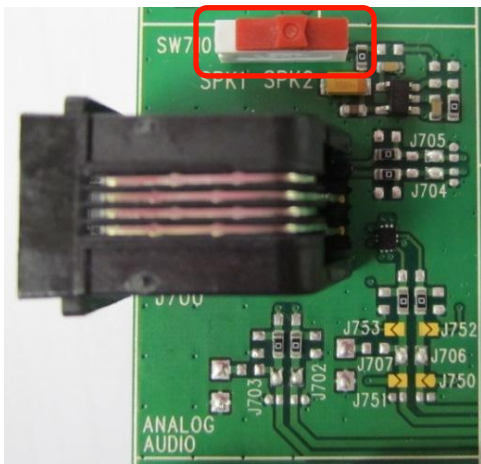

Figure 35. SW710 Configuration with a WISMO2x8 Socket Board

4.5.3. Analog Audio Connection Mode

Both microphone (MIC) and speaker signals (SPKx) of the AirPrime WS Series embedded module can be configured in either single-ended or differential mode. By default, both microphone and speaker signals are set to differential mode on the AirPrime WS Series Development Kit. The following diagrams show how the AirPrime WS Series Development Kit should be configured for a differential microphone and speaker.

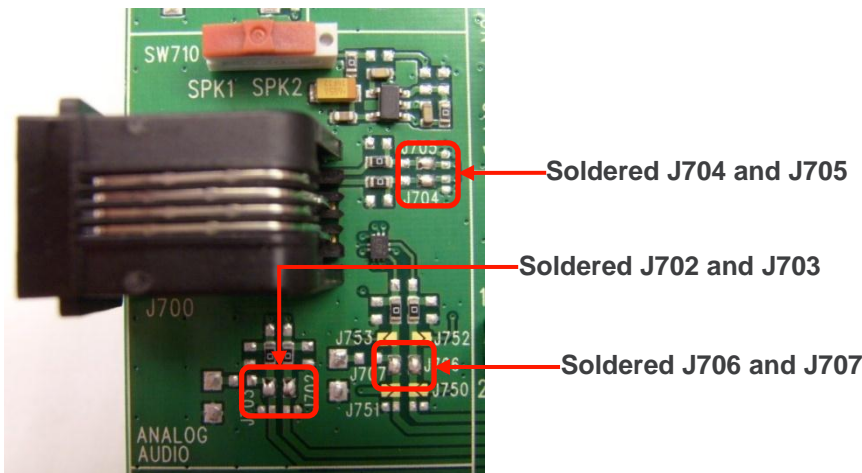

Figure 36. Settings for a Differential Microphone

For a single-ended microphone connection, the settings on the AirPrime WS Series Development Kit Board should be modified as follows.

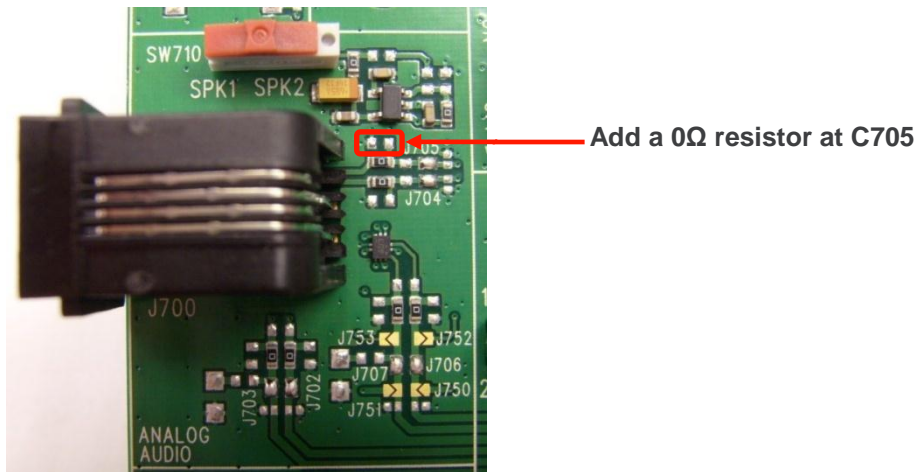

Figure 37. Settings for a Single-Ended Microphone

For a single-ended speaker connection, the settings on the AirPrime WS Series Development Kit Board should be modified as follows.

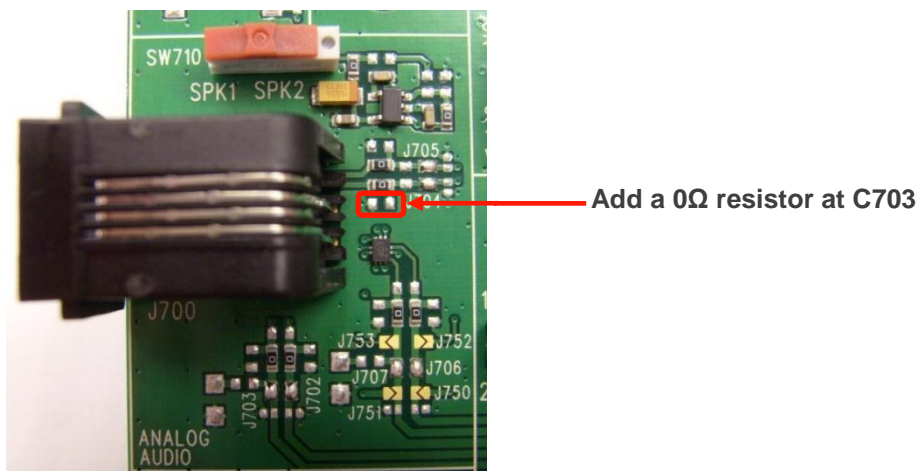

Figure 38. Settings for a Single-Ended Speaker

For more information about differential and single-ended audio configurations, refer to the Product Technical Specification and Customer Design Guideline of the corresponding AirPrime WS Series embedded module.

4.6. Digital Audio Interface (PCM)

Note: This interface is only available for use with the WS6318 Socket Board.

The digital audio interface (PCM) allows connectivity with standard audio peripherals. For more information about the digital audio interface, refer to document [3] AirPrime WS6318 Product Technical Specification and Customer Design Guidelines.

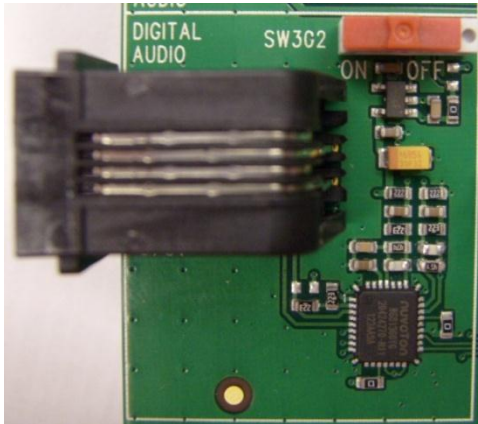

Figure 39. Digital Audio Interface (PCM)

4.6.1. Digital Audio Connector (J701)

J701 is an RJ9 4-pin connector.

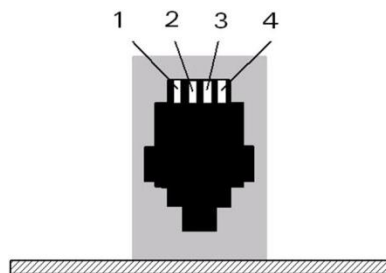

Figure 40. RJ9 4-pin Connector for Digital Audio

Refer to the following table for the digital audio (PCM) connector signal pin description.

Table 10. Digital Audio (PCM) Connector Pin Description

Pin Number	Signal Name	I/O	I/O Type	Description
1	Digital MICN	I	Analog	Digital microphone negative input
2	Digital SPKxN	O	Analog	Digital speaker negative output
3	Digital SPKxP	O	Analog	Digital speaker positive output
4	Digital MICP	I	Analog	Digital microphone positive input

4.6.2. Enabling the Digital Audio (PCM) Function (SW302)

The digital audio (PCM) interface can be enabled by switching SW302 to the “ON” position.

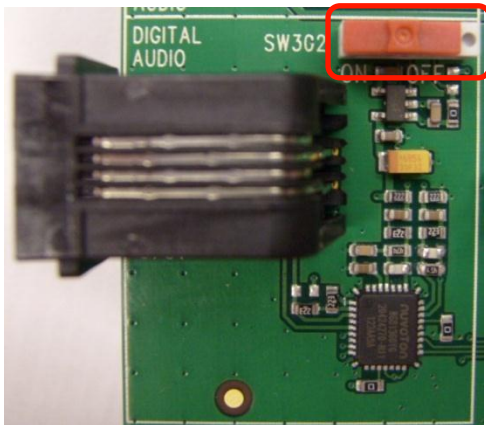

Figure 41. Digital Audio (PCM) Switch Configuration

4.7. Flash_LED (LED, D602)

The LED location is shown in the following figure.

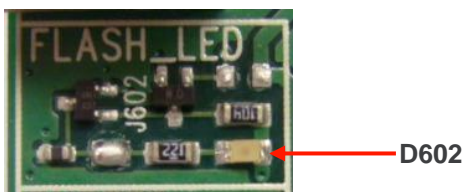

Figure 42. Flash_LED Location

The LED indicator, D602, is a green LED that indicates the network status.

For more information, refer to the Product Technical Specification and Customer Design Guideline of the corresponding AirPrime WS Series embedded module.

4.8. Buzzer LED (BUZZER, D600)

The BUZZER location is shown in the figure below.

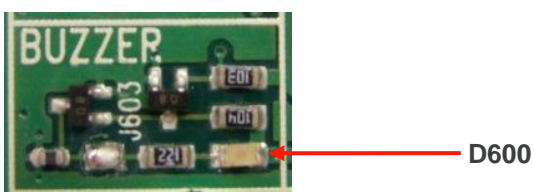

Figure 43. BUZZER Location

The BUZZER indicator, D600, is a green LED that is controlled by the BUZZER signal of the AirPrime WS Series embedded module.

For more information, refer to the Product Technical Specification and Customer Design Guideline of the corresponding AirPrime WS Series embedded module.

4.9. JTAG

The JTAG interface is used for hardware debugging and product troubleshooting.

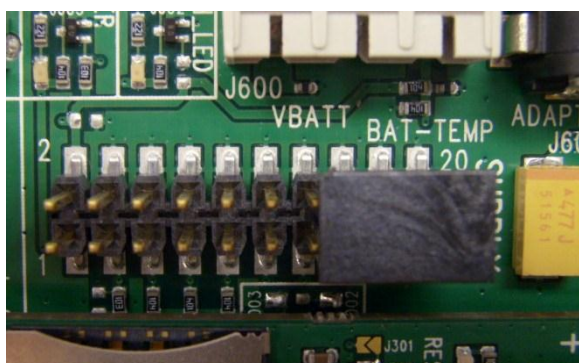

Figure 44. JTAG Connector

4.9.1. JTAG Connector

Refer to the following table for the JTAG connector pin description.

Table 11. JTAG Connector Pin Description

Pin Number	Signal Name	I/O	I/O Type	Description
1	VCC_2V8	O	2V8	2.8V Digital Supply
2	VCC_2V8	O	2V8	2.8V Digital Supply
3	TP5	I	2V8	Test Point 5
4	GND	-	-	GROUND
5	TP4	I	2V8	Test Point 4
6	GND	-	-	GROUND
7	TP3	I	2V8	Test Point 3
8	GND	-	-	GROUND
9	TP1	I	2V8	Test Point 1
10	GND	-	-	GROUND
11	TP6	O	2V8	Test Point 6
12	GND	-	-	GROUND
13	TP2	O	2V8	Test Point 2
14	GND	-	-	GROUND
15	~RESET	I/O	Pull-up inside the module	Reset Input
16	GND	-	-	GROUND
17	GND	-	-	GROUND
18	GND	-	-	GROUND
19	GND	-	-	GROUND
20	GND	-	-	GROUND

4.10. Other Interfaces

Other interfaces and signals available on the AirPrime WS Series Development Kit Board are available on the test points at the center of the development kit board. The following sub-sections describe these additional interfaces and signals.

Refer to section 2.6 Available Test Ports on the AirPrime WS Series Development Kit for the test point location and the pin description.

For further technical information, refer to the Product Technical Specification and Customer Design Guideline of the corresponding AirPrime WS Series embedded module.

4.10.1. Power Supply Function

These outputs (2V8_LDO and VCC_2V8) from the AirPrime WS Series embedded module can be used to connect pull-up resistors. Both power outputs are 2.8V types. Note that these power supplies must only be used as a reference supply.

4.10.2. Backup Battery Function

The AirPrime WS Series embedded module provides an input/output signal, BAT-RTC, for connecting a Real Time Clock power supply. This pin is used as a backup power supply to preserve the date and time when VBATT is switched OFF (no VBATT).

4.10.3. ADC Function

The AirPrime WS6318 embedded module provides two analog to digital converters, AUX-ADC0 and AUX-ADC1; while the WISMO2x8 embedded module only provides AUX-ADC0. These converters are 10-bit resolution ADCs ranging from 0V to 1V (AUX-ADC0) and 0v to 3V (AUX-ADC1).

For more information about this interface, refer to the Product Technical Specification and Customer Design Guideline of the corresponding AirPrime WS Series embedded module.

4.10.3.1. AUX-ADC0

This analog input signal can be used to monitor external (application) temperature.

4.10.3.2. AUX-ADC1

This input may be used for customer specific applications.



5. Interfaces/Peripherals on the Socket Board

This section describes the different interfaces/peripherals that are available on the Socket Board.

5.1. Antenna Function

An SMA connector used for customer applications is available on the socket board.



Figure 45. SMA Connector on the WISMO2x8 Socket Board



Figure 46. SMA Connector on the WS6318 Socket Board

>> 6. Control Functions

This section describes the control functions available in the AirPrime WS Series Development Kit.

6.1. ON/~OFF

The AirPrime WS Series Development Kit board is always turned ON when power is supplied via J600 (DC external supply) or J604 (AC/DC adapter). Interfaces and peripherals on the development kit are individually switched ON when their corresponding switches are in the “ON” position.

6.1.1. WISMO2x8 Socket Board

To switch the embedded module soldered to a WISMO2x8 socket board ON, press BP101 on the WISMO2x8 socket board.



Figure 47. AirPrime WISMO2x8 Embedded Module ON/~OFF Switch on the WISMO2x8 Socket Board

For more information about the ON/~OFF signal of the embedded module, refer to documents [1] AirPrime WISMO218 Product Technical Specification and Customer Design Guideline and [2] AirPrime WISMO228 Product Technical Specification and Customer Design Guideline.

6.1.2. WS6318 Socket Board

To switch the embedded module soldered to a WS6318 socket board ON, make sure the ON/~OFF switch is in the “L” position.

Alternatively, you can push the ON/~OFF button when the ON/~OFF switch is in the “OPEN” position to switch the embedded module ON.

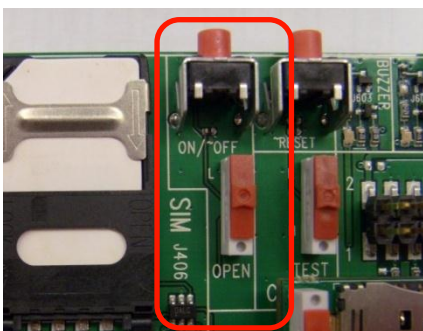

Figure 48. AirPrime WS6318 Embedded Module ON/~OFF Switch on the Development Kit Board

For more information about the ON/~OFF signal of the embedded module, refer to document [3] AirPrime WS6318 Product Technical Specification and Customer Design Guidelines.

6.2. ~RESET

The ~RESET button starts a general reset when it is pushed.

Caution: *A software reset is preferred to a hardware reset.*

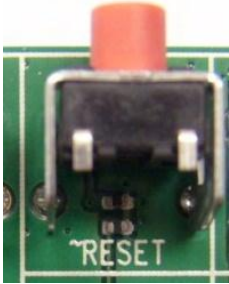

Figure 49. ~RESET Button

For more information about this signal, refer to the Product Technical Specification and Customer Design Guideline of the corresponding AirPrime WS Series embedded module.

7. ESD Protections

External ESD protections are available on the AirPrime WS Series Development Kit for the following signals:

- SIM interface signals:
 - SIM-VCC
 - SIM-IO
 - SIM-CLK
 - SIM-RST
- Analog Audio

Other interface signals protected on the AirPrime WS Series embedded module are as follows:

- UART1 signals with the ADM3307 transceiver
- UART2 signals with the LTC2804 transceiver

Caution: *As the test points at the center of the AirPrime WS Series Development Kit are not protected against ESD and they are directly connected to the signal pins of the AirPrime WS Series embedded module, users must be careful when using these TP signals.*



8. Current Consumption Measurement

To measure the current consumption of the AirPrime WS Series embedded module, configure the AirPrime WS Series Development Kit as shown below.

Caution: Before making any of these adjustments, ensure that the AirPrime WS Series Development Kit is disconnected from the power supply.

Note that with the configuration described below, the current consumption from VBATT is only that of the AirPrime WS Series embedded module soldered-down. For more information about the AirPrime WS Series embedded module and its current consumption, refer to the Product Technical Specification and Customer Design Guideline of the corresponding AirPrime WS Series embedded module.

Also, C600 and D604 connected on 4V (VBATT) may affect power consumption on 4V (VBATT). Disconnect these 2 components if necessary.

Configure the AirPrime WS Series Development Kit Board and measure power consumption as follows:

- Around the Power Supply area:
 - Unsolder jumper J605 to disconnect VBATT and VBAT.



- Around the UART2 area:
 - Disconnect UART2 from the embedded module by opening soldering jumpers J201 to J204.

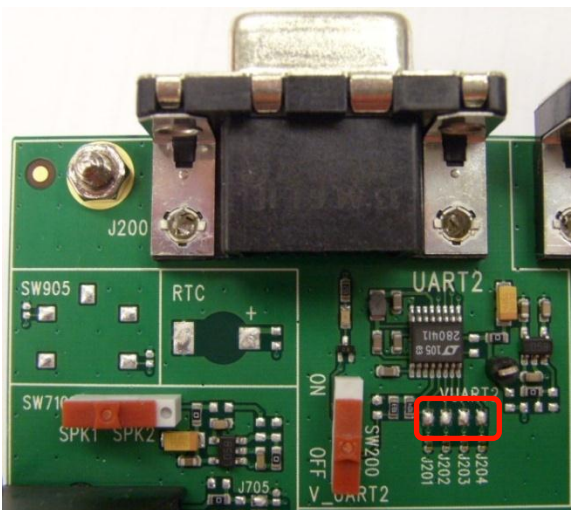

- Around the VBATT area:
 - Remove C600 and D604 in order to eliminate the current drawn by the application circuit on the AirPrime WS Series Development Kit.

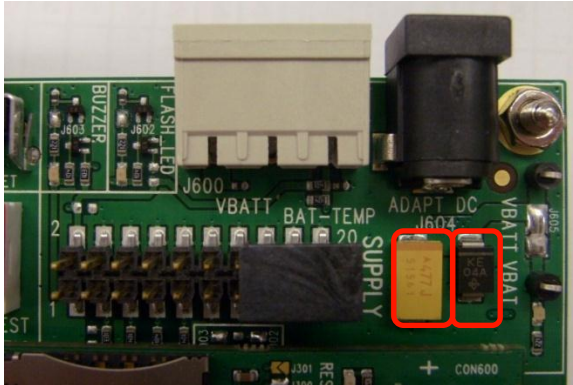

- Remove R600, R601, V600 and R615

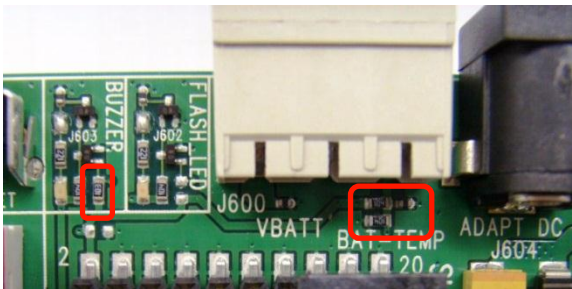

- Open soldering jumper J605 in order to separate the power supplies of the AirPrime WS Series Development Kit and the AirPrime WS Series embedded module.
- Connect an external power supply to J600, VBATT, to supply the embedded module.
- Connect an additional 4V external power supply to the test point TP602 (“VBAT”) and ground. This will be used to supply the peripherals on the development kit board.

Note: The current from J600 is supplied to the AirPrime WS Series embedded module; while the current from TP602 is supplied to the AirPrime WS Series Development Kit.

- Switch SW601 to “L”

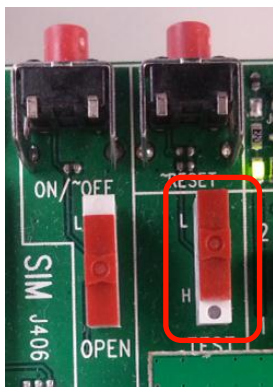

- Ensure that a SIM card is properly inserted in the SIM connector, J406.
- Set the CMU to GSM paging 9 or 2 for reception burst periodic frequency.

Note: When using a WS6318 embedded module, SW600 should be in the “L” position just after the embedded module is powered ON. However, SW600 needs to be switched to “OPEN” to accurately measure the sleep mode current consumption of the embedded module.

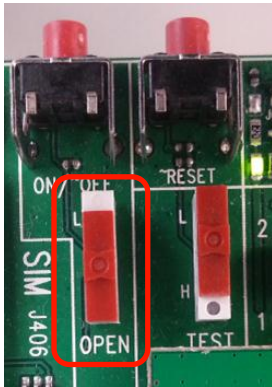
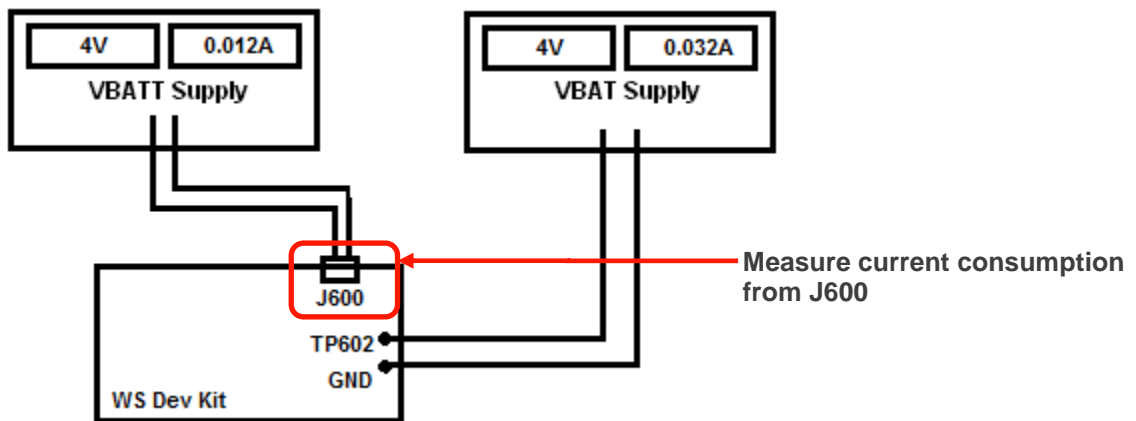

Figure 50. SW600 in the “OPEN” Position

- Wait for a few seconds before measuring the current consumption of the AirPrime WS Series embedded module from J600.





9. Reference Documents

- [1] AirPrime WISMO218 Product Technical Specification and Customer Design Guidelines
Reference: 4111957
- [2] AirPrime WISMO228 Product Technical Specification and Customer Design Guidelines
Reference: 4111958
- [3] AirPrime WS6318 Product Technical Specification and Customer Design Guidelines
Reference: 4110999
- [4] AirPrime WS Series Firmware L23b AT Command Manual
Reference: 4112935
- [5] AirPrime WS6318 Firmware L31 AT Command Manual
Reference: 4112646
- [6] AirPrime WS Series Development Kit User Guide
(for board versions earlier than 1499682-B)
Reference: 4110966



10. List of Abbreviations

Abbreviation	Definition
ADC	Analog to Digital Converter
AUX	AUXiliary
CLK	CLock
CPU	Central Process Unit
CTS	Clear To Send
DAC	Digital to Analog Converter
DC	Direct Current
DCD	Data Carrier Detect
DCE	Data Communication Equipment
DSR	Data Set Ready
DTE	Data Terminal Equipment
DTR	Data Terminal Ready
ESD	ElectroStatic Discharges
GND	GrouND
GPI	General Purpose Input
GPIO	General Purpose Input Output
GPO	General Purpose Output
IIC (I2C)	Inter IC Control bus
I/O	Input / Output
MIC	MICrophone
PC	Personal Computer
PCB	Printed Circuit Board.
PCM	Pulse Code Modulation
PWM	Pulse Width Modulation
RF	Radio Frequency
RI	Ring Indicator
RTC	Real Time Clock
RTS	Request To Send
RXD	Receive Data
SIM	Subscriber Identity Module
SPI	Serial Peripheral Interface
SPK	SPeaKer
TP	Test Point
TXD	Transmit Data
UART	Universal Asynchronous Receiver-Transmitter
USB	Universal Serial Bus



11. Appendix

This section contains schematic diagrams for the AirPrime WS Series Development Kit and Socket Board.

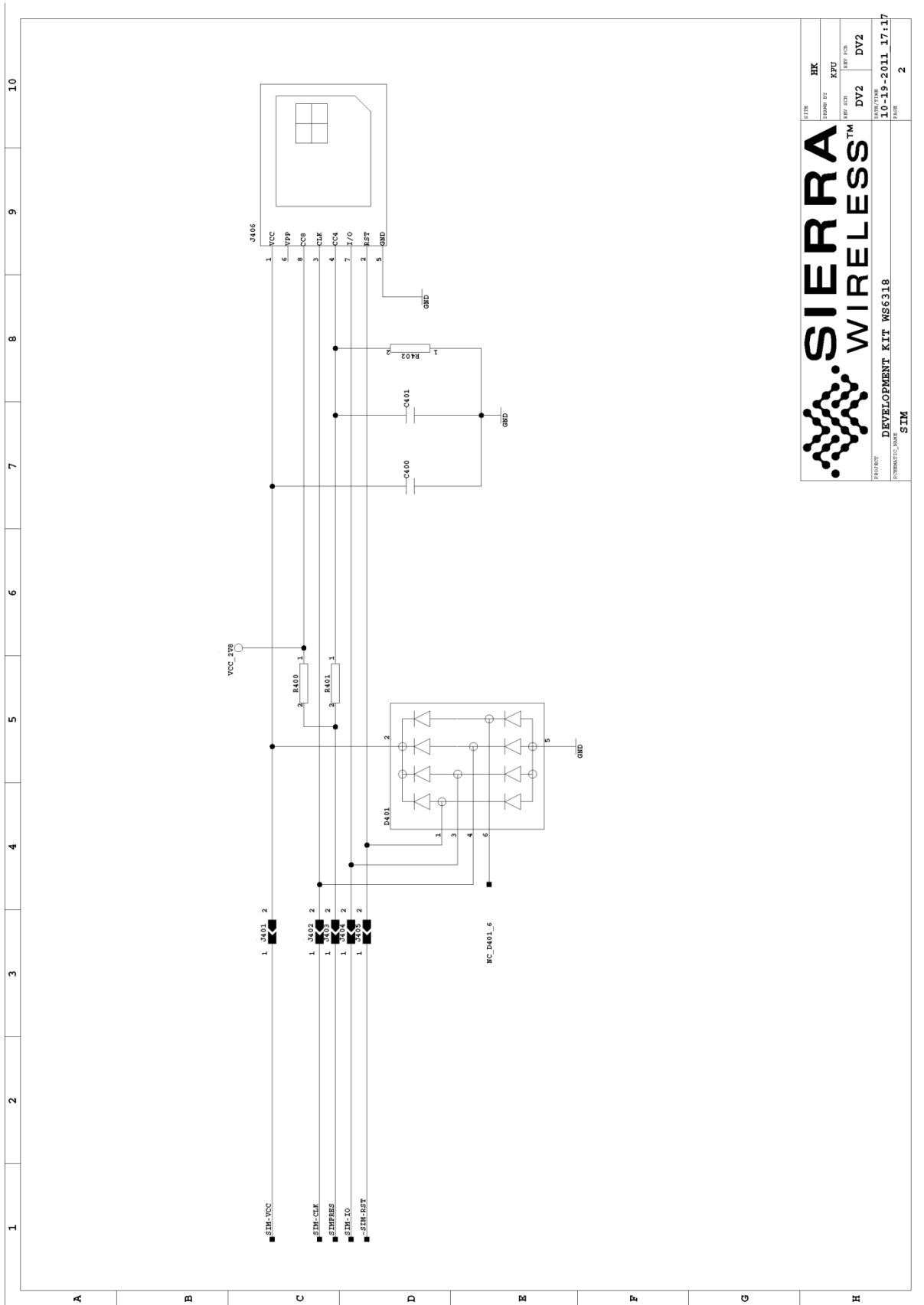

DATE	HK
DESIGN BY	KFU
EMP. NO.	DV2
DATE FILED	DV2
PROJECT	10-19-2011 17:17
SYMBOLIC NAME	SIM
PAGE	2

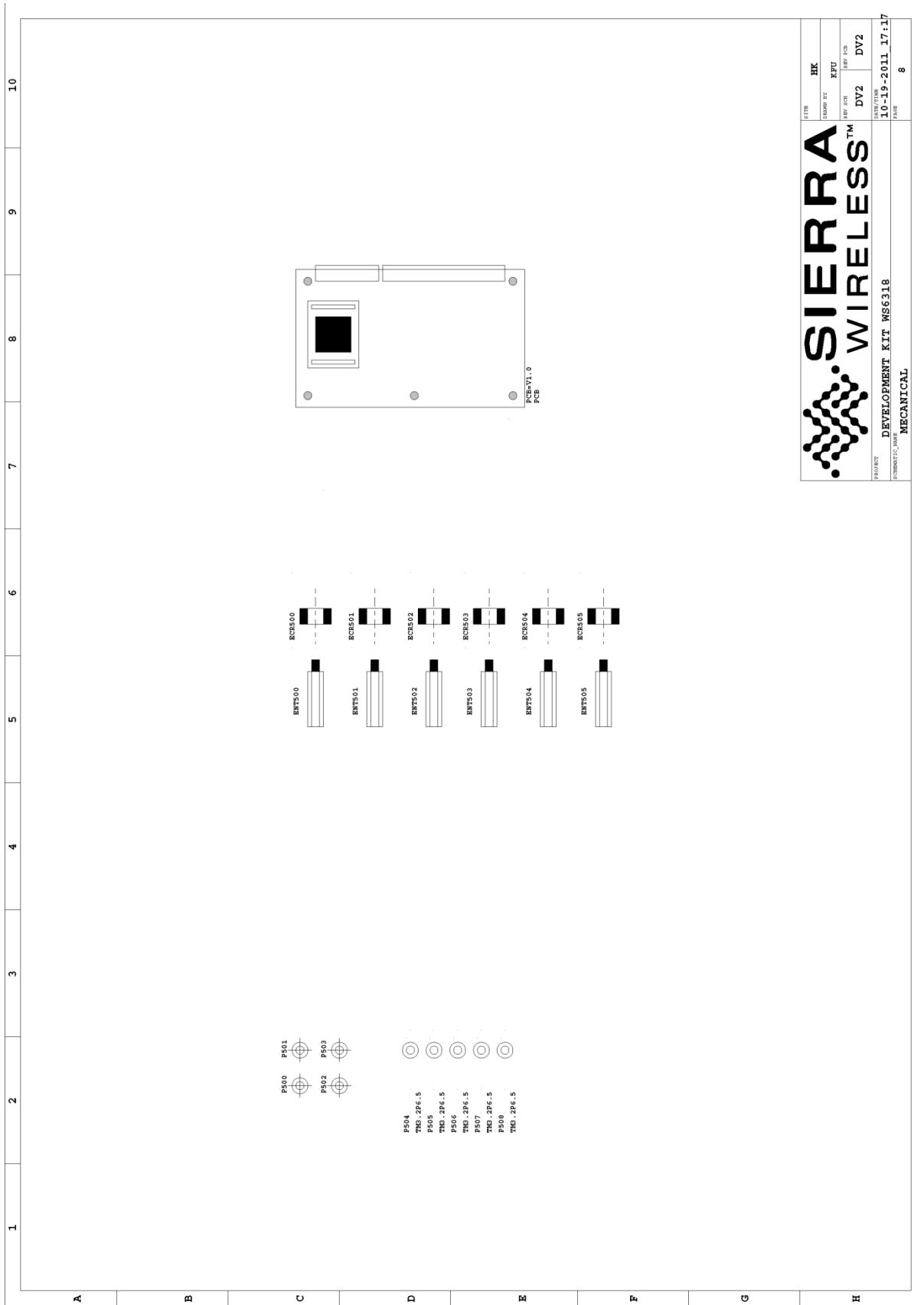

DATE	HK
DESIGN BY	KFU
EMP. NO.	DV2
DATE FILED	DV2
PROJECT	10-19-2011 17:17
SYMBOLIC NAME	MECHANICAL
PAGE	8

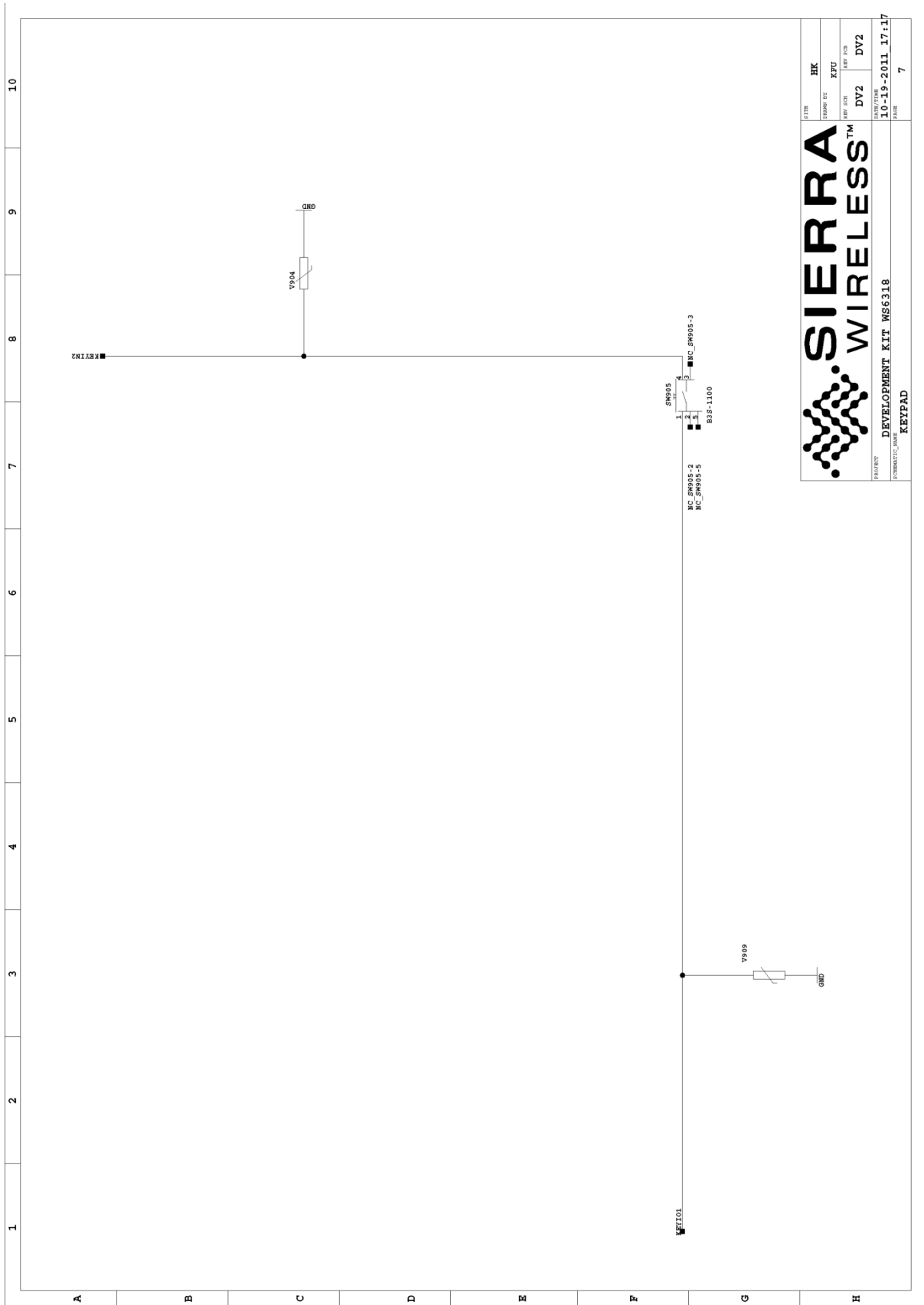

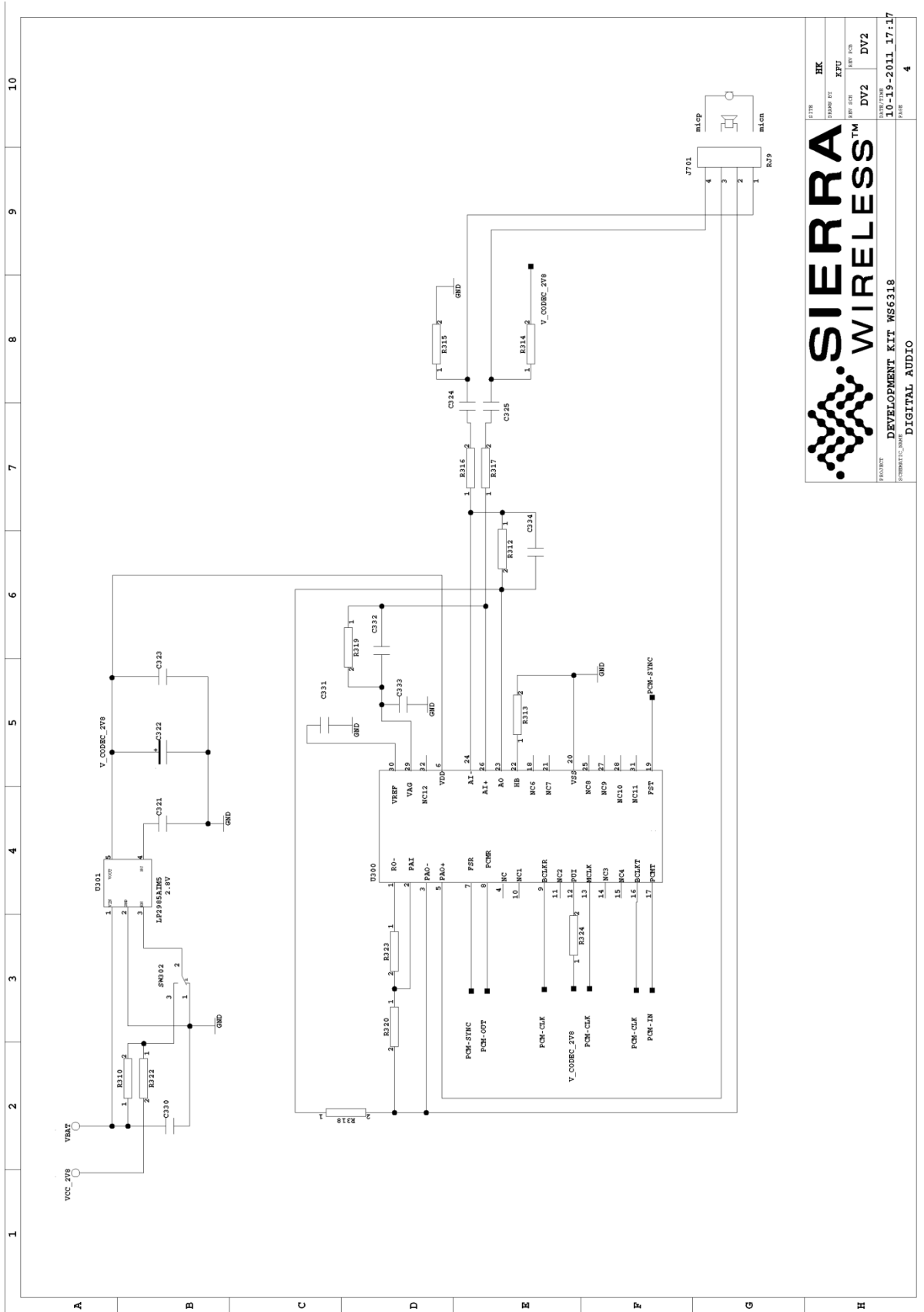

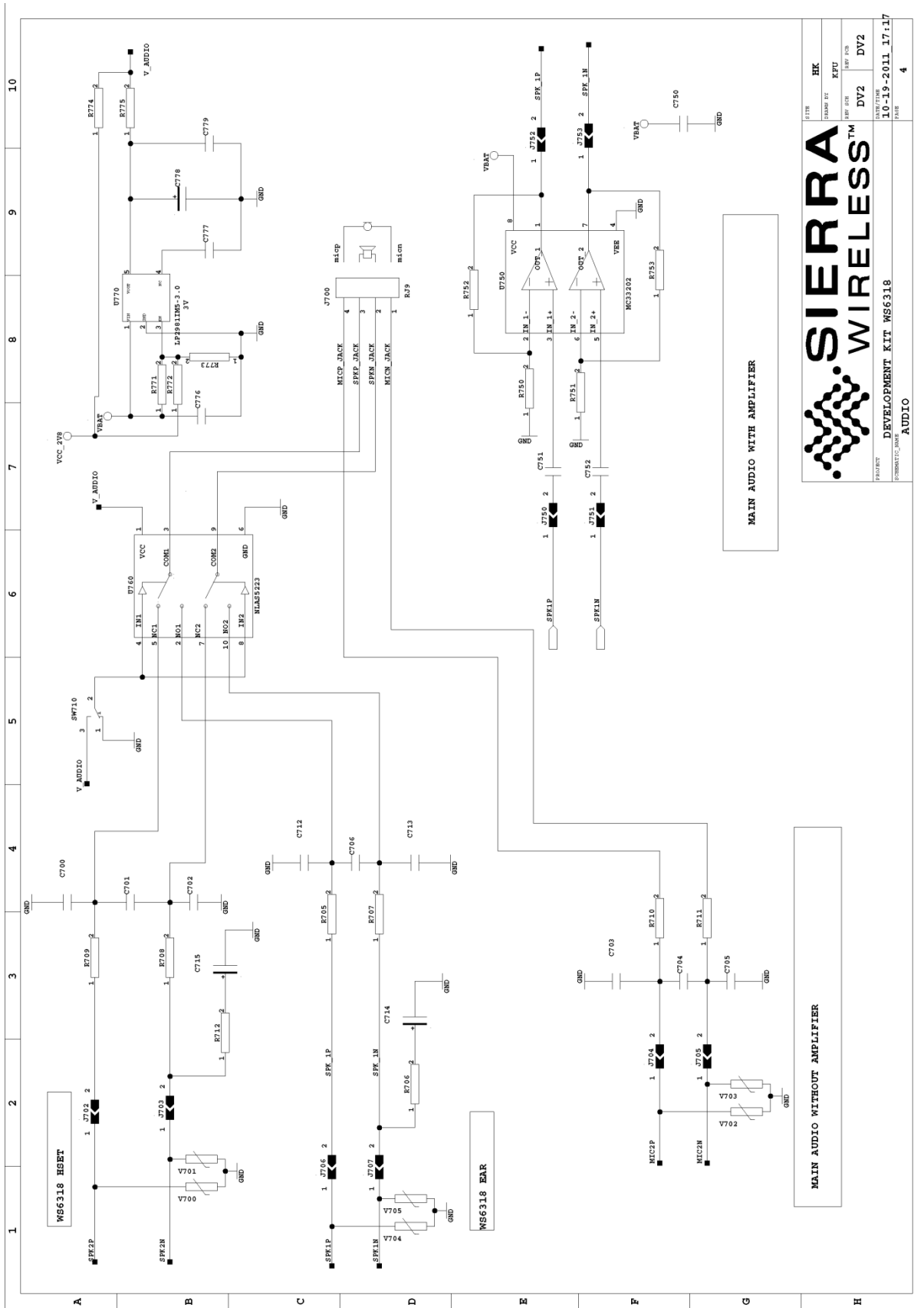

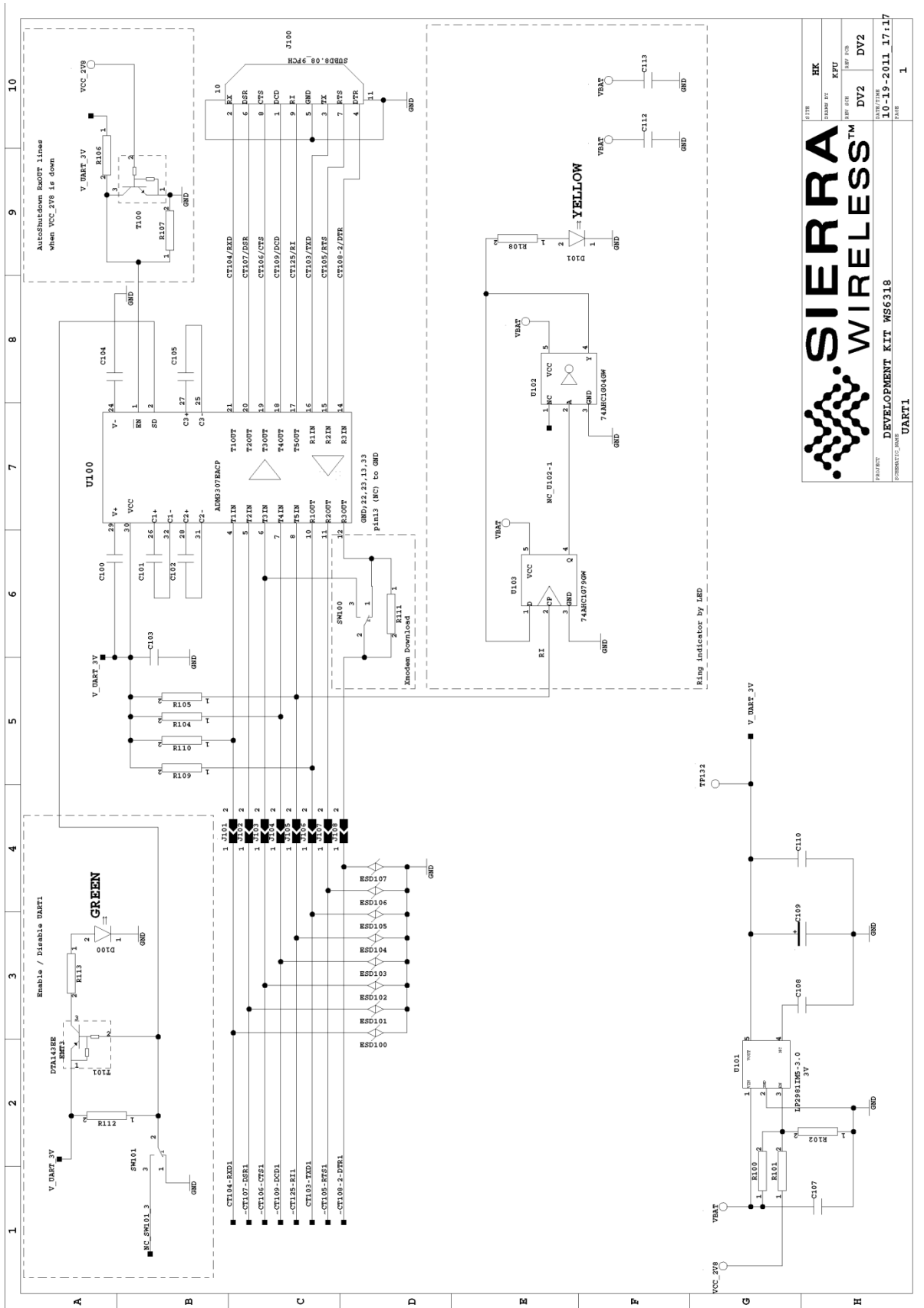

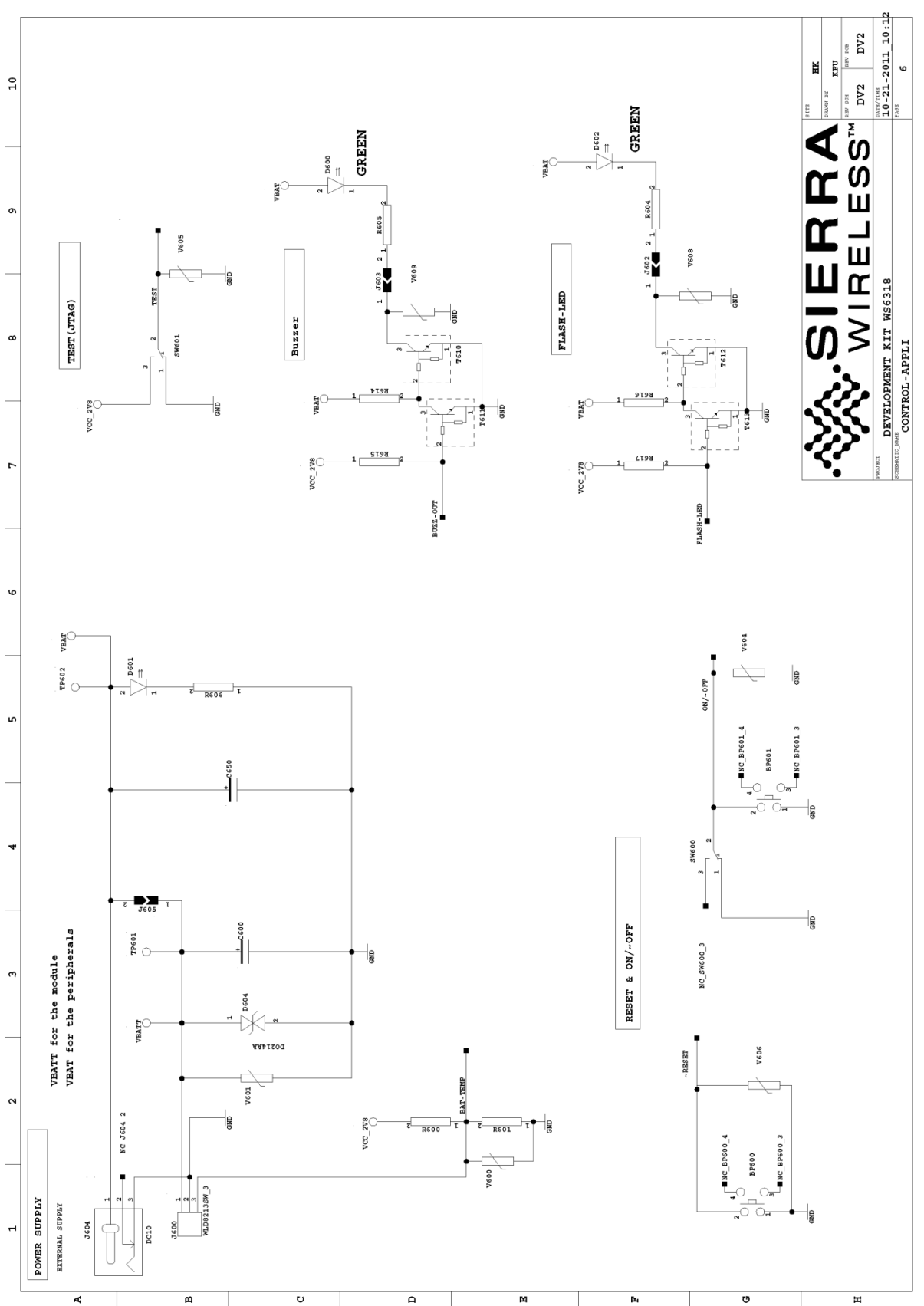



SIERRA WIRELESS™

DEVELOPMENT KIT WS6318
CONNECTOR + 3.2K

DATE: 10-19-2011 17:17

REV: 9

SOCKET_UP_LOCATION_HOLE P1

SOCKET_UP_LOCATION_HOLE P2

SOCKET_UP_LOCATION_HOLE P3

SOCKET_UP_LOCATION_HOLE P4

SOCKET_DP_LOCATION_HOLE

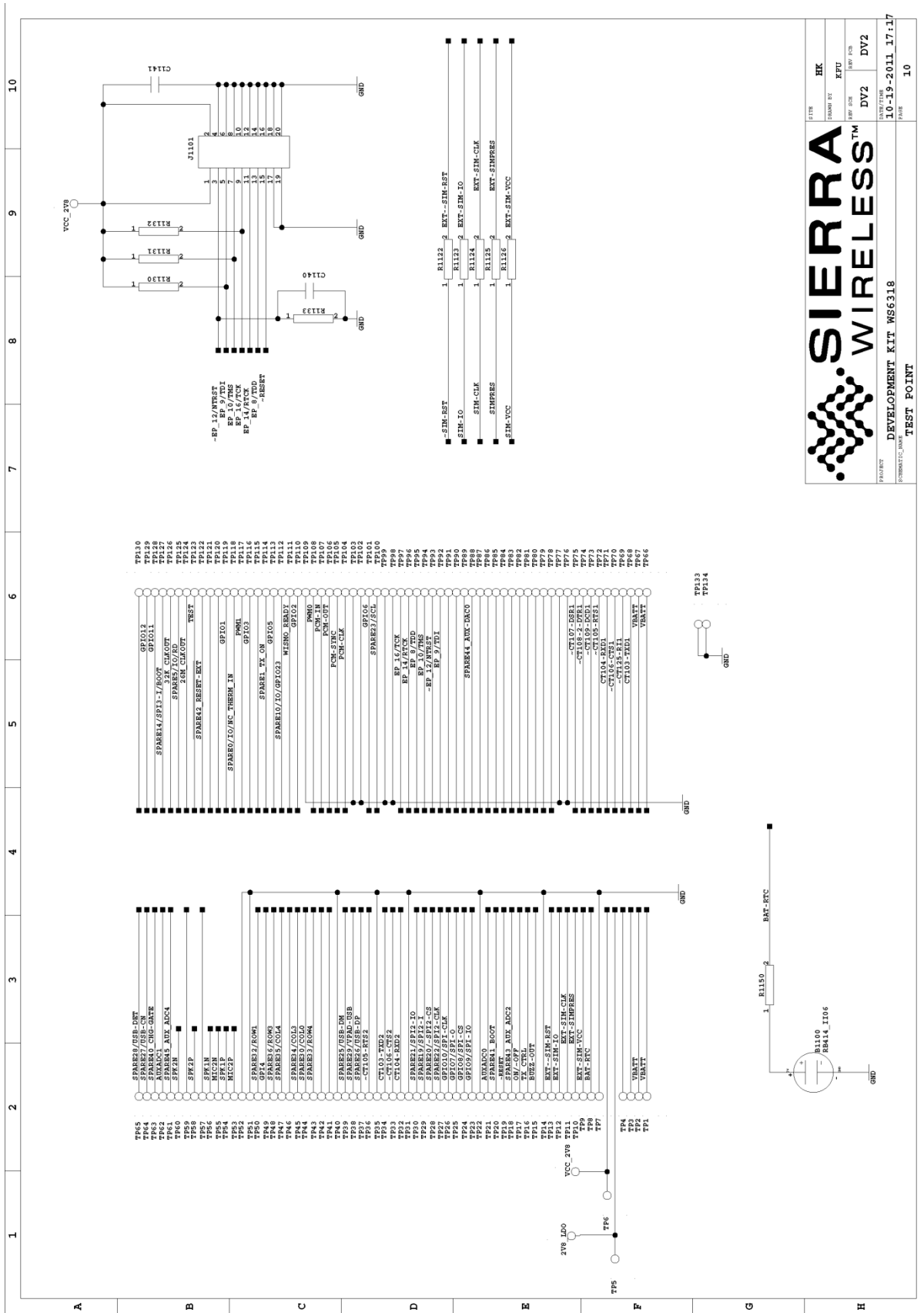

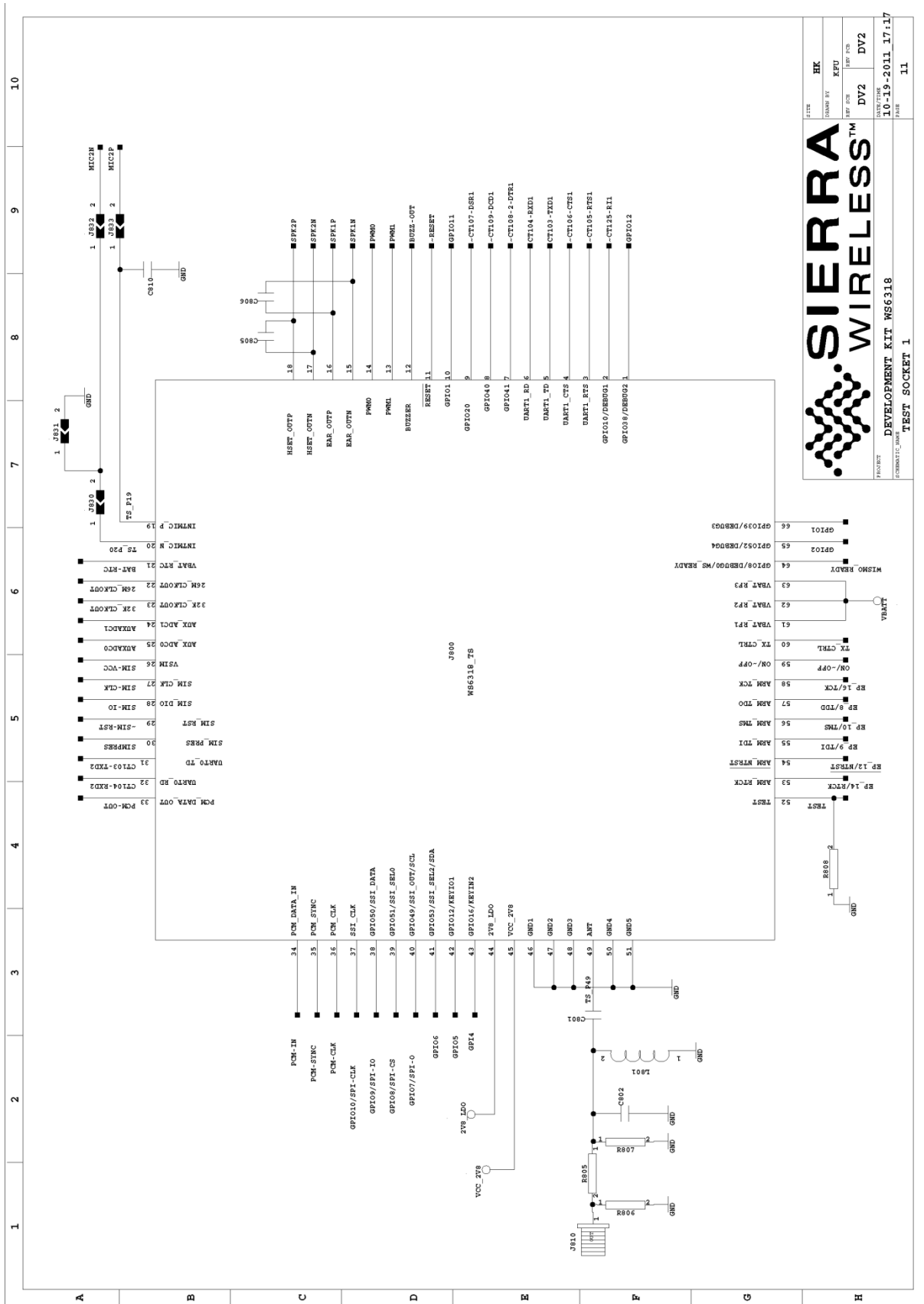

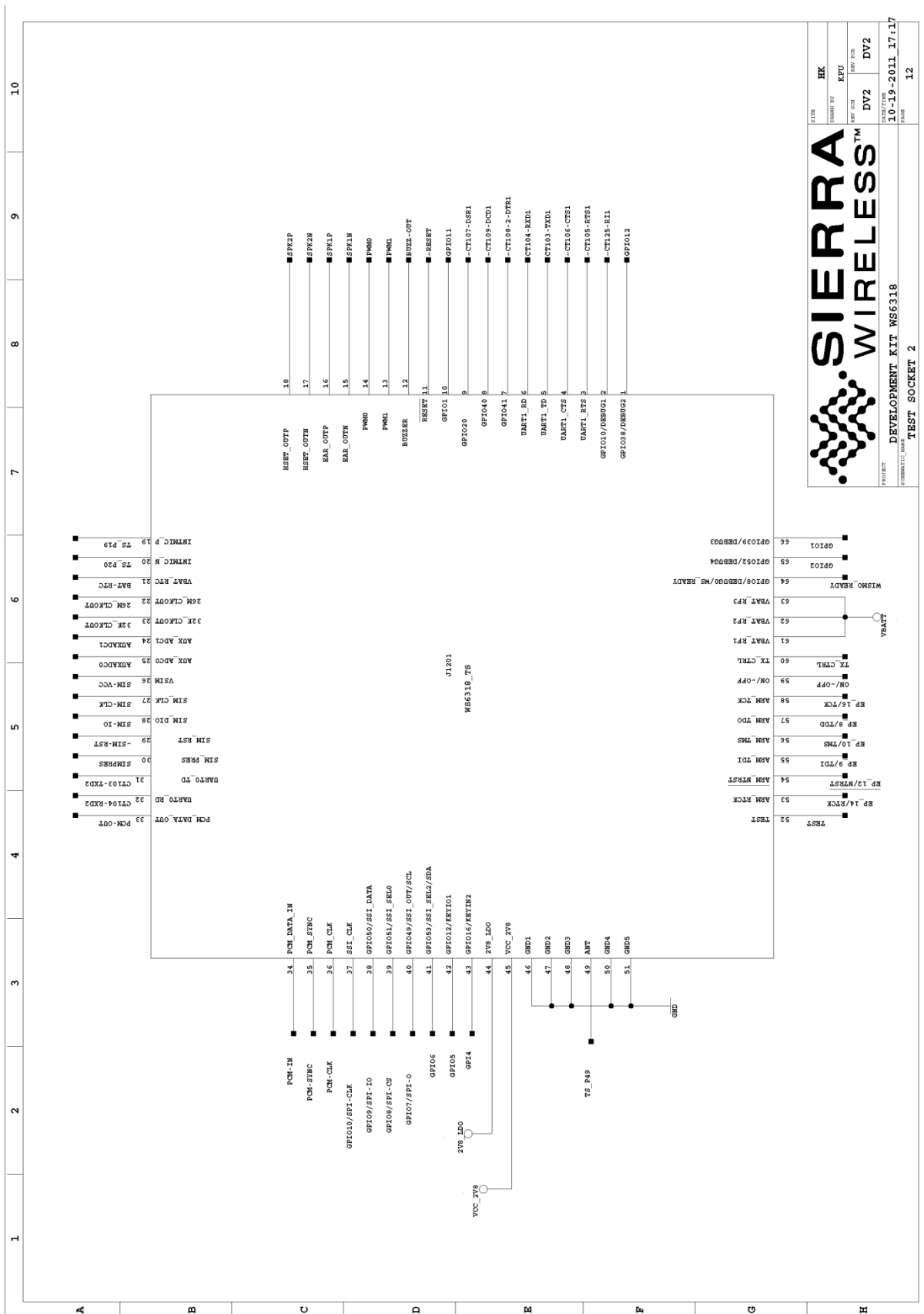

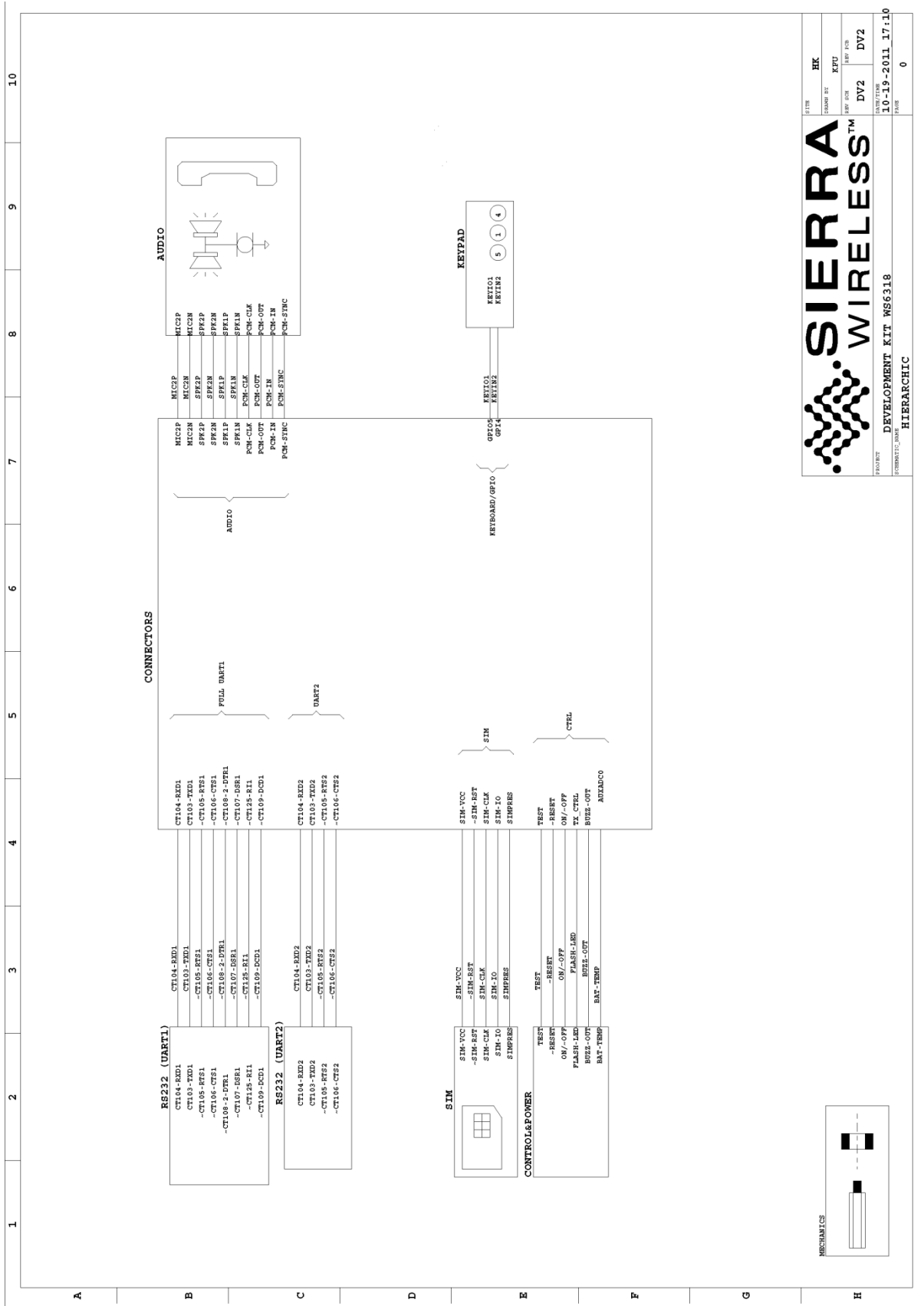

SIERRA WIRELESS™

DEVELOPMENT KIT WS6318
HIERARCHIC

DATE	HK
DESIGNER	KFU
REP. USER	REP. PCB
DWG. NO.	DV2
DATE PLOTTED	10-19-2011 17:10
PAGE	0

11.2. AirPrime WISMO2x8 Socket Board

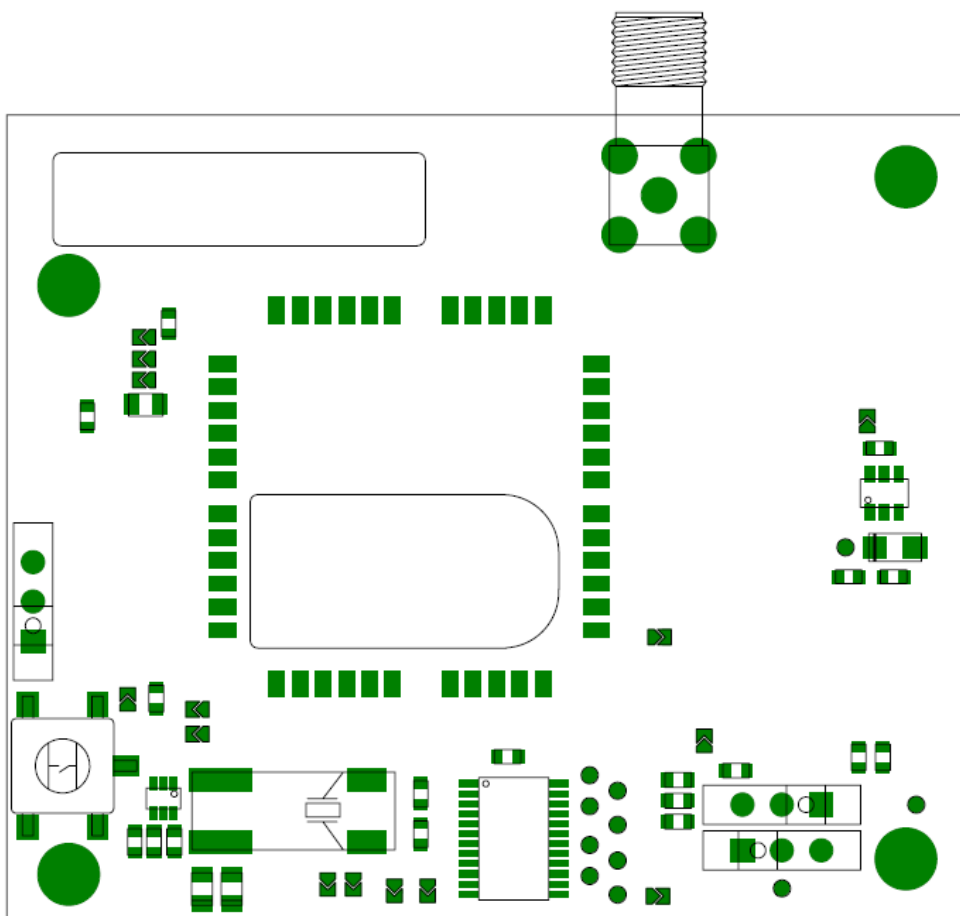

Figure 51. AirPrime WISMO2x8 Socket Board Assembly (Top View)

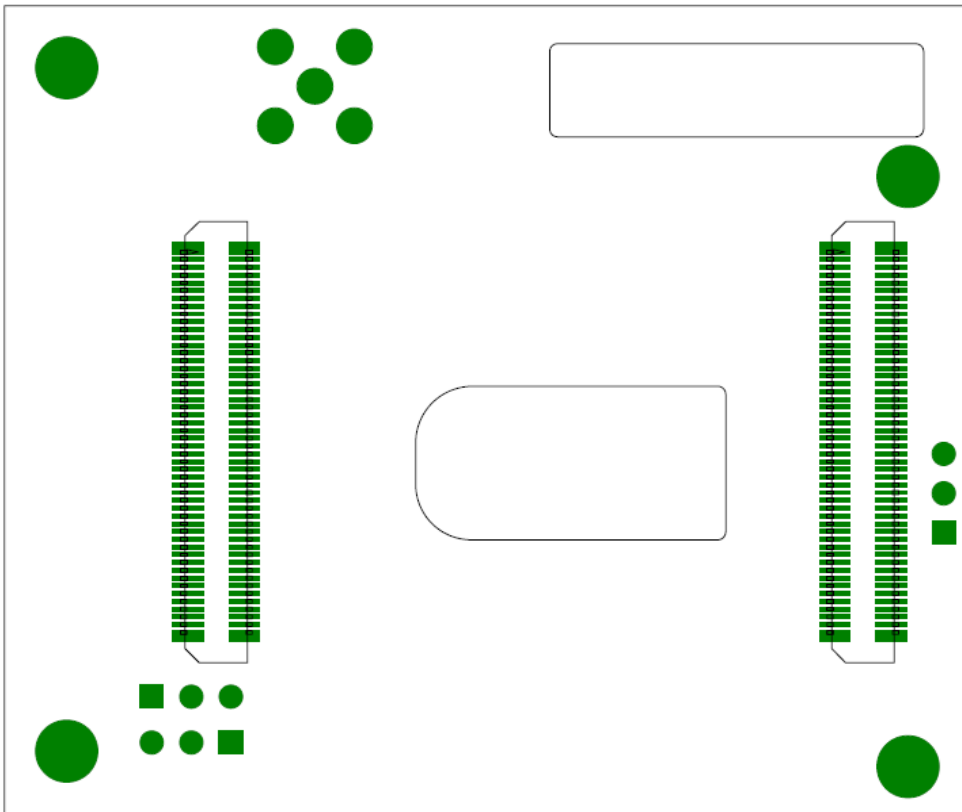
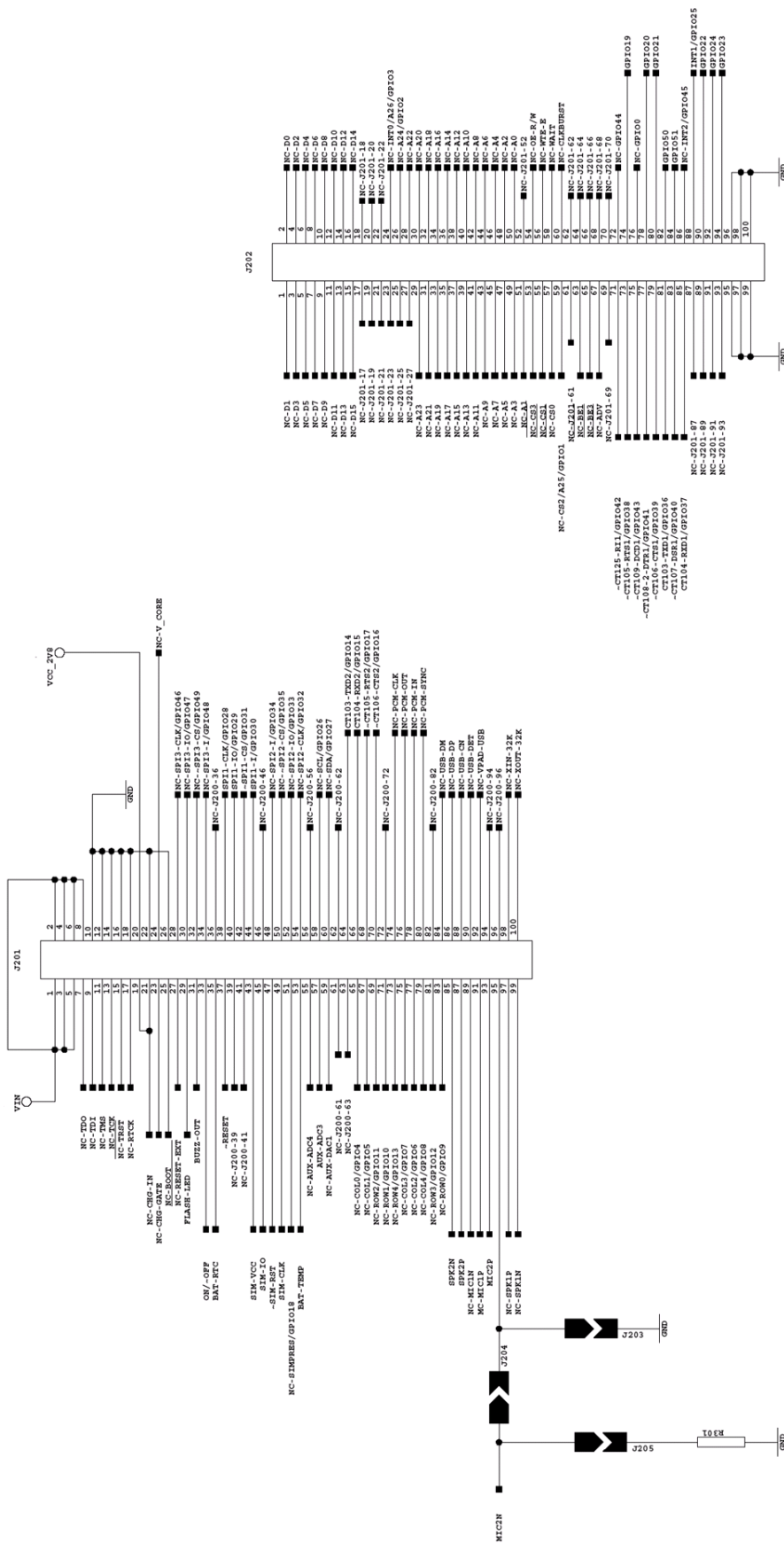

Figure 52. AirPrime WISMO2x8 Socket Board Assembly (Bottom View)



PROJECT: WISMO 218 SOCKET UP

SCHEMATIC: WPMXX DEV KIT CONNECTOR

Date: 15/02/2009

Version: 2.0

Validated by:

Made by: MCO

Sheet : 3/3

11.3. AirPrime WS6318 Socket Board

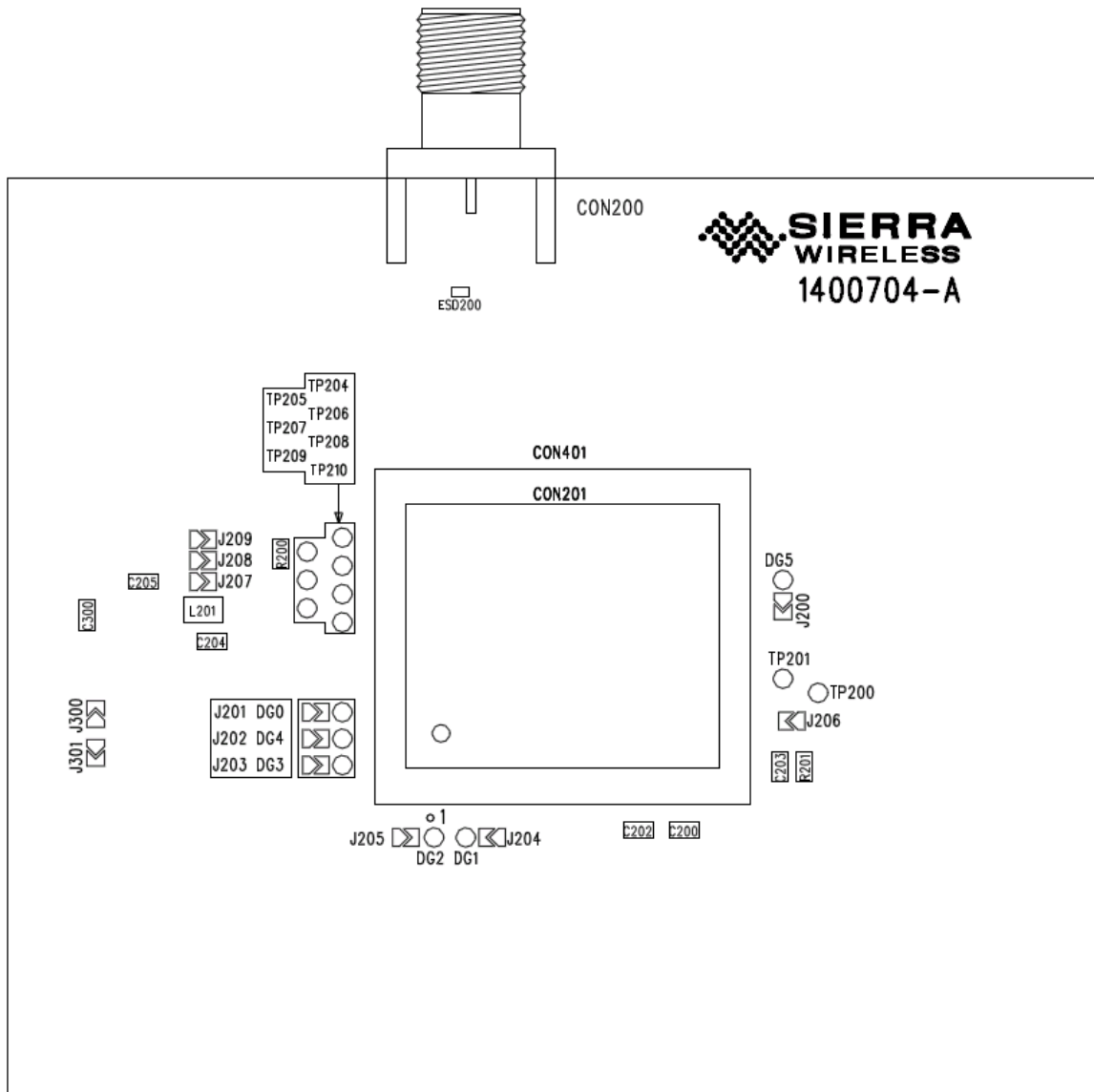
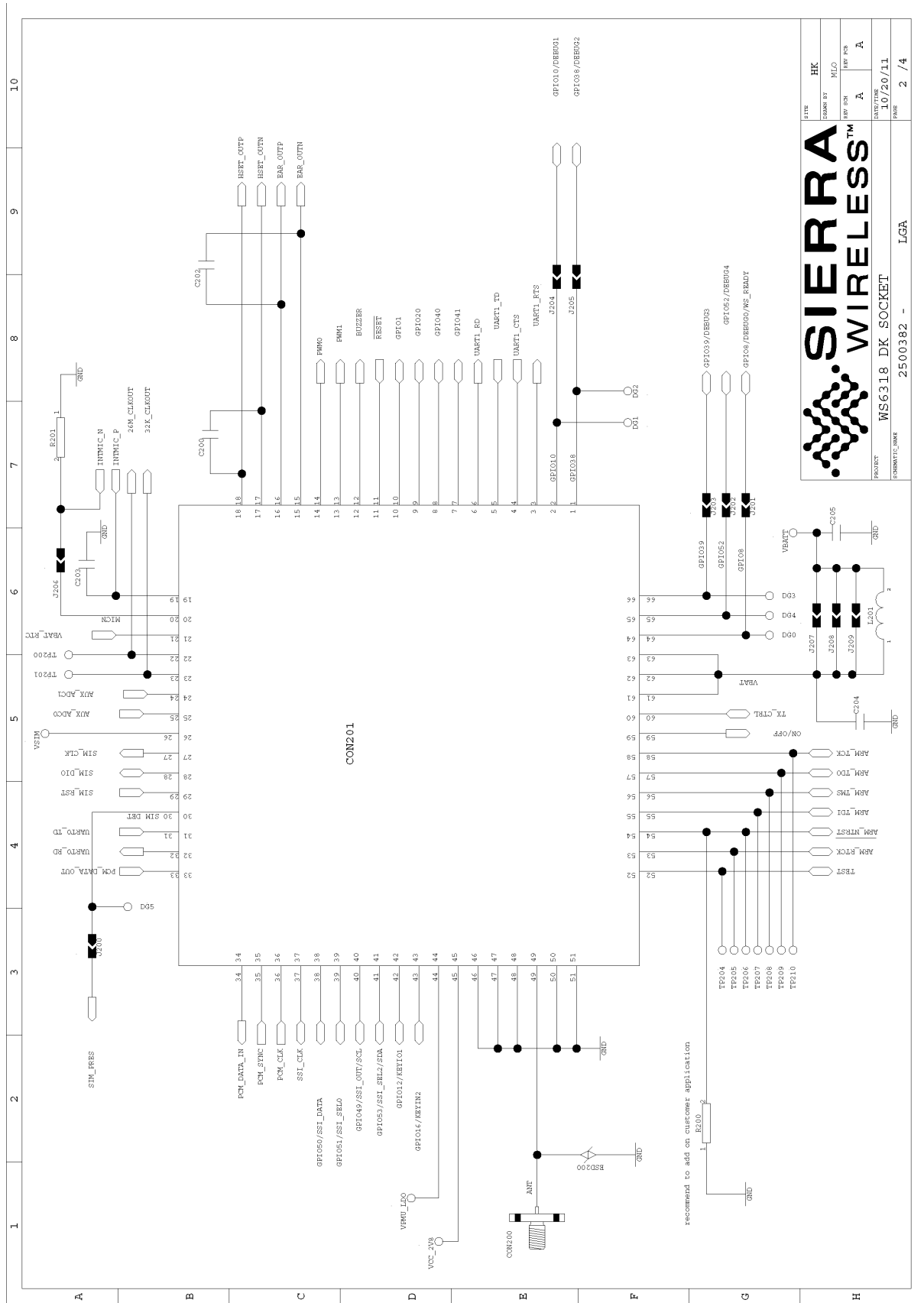
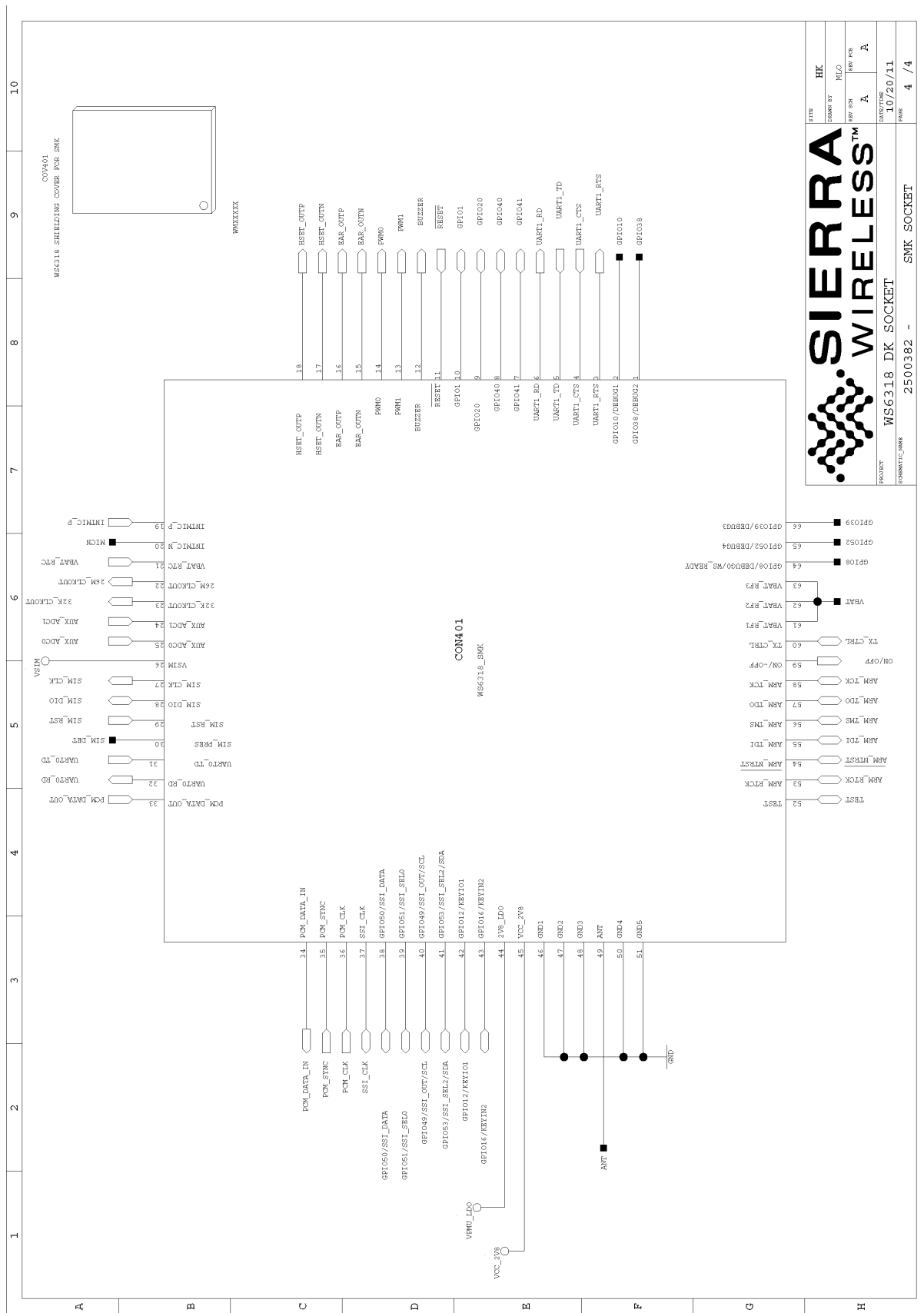

Figure 53. AirPrime WS6318 Socket Board Component Placement Diagram (Top View)



PROJECT	WS6318 DK SOCKET
DATE/REV	10/20/11
REV. NO.	A
REV. PKG.	A
DESIGN BY	MLO
DATE	10/20/11
FILE	HK

PROJECT: WS6318 DK SOCKET
 SUBSTRATE: LGA
 PART: 2500382 - LGA
 PAGE: 2 / 4





SIERRA
WIRELESS