

**Strength** and **Durability** for **LiFe®**



**GUIDELINES**

# **Installation Guide for Ductile Iron Pipe**

Last Revised:  
September 2021

## About the Ductile Iron Pipe Research Association (DIPRA)

From its inception more than 100 years ago, the Ductile Iron Pipe Research Association (DIPRA) has provided accurate, reliable, and essential engineering information about iron pipe to a wide variety of utilities and consulting engineers.

Founded in 1915, the organization's initial role was to promote the superior qualities of iron pipe through advertising programs. Over time, it has evolved to become a technically based and research-oriented organization. DIPRA provides a variety of resources and services, such as brochures and publications, representation on standards-making committees, technical research on applications-based topics (such as corrosion control and design of Ductile iron pipe), and personal technical services through our regional engineer program.

While DIPRA member companies have different names and locations, they share a common commitment to produce and deliver the finest quality water and wastewater pipe material in the world: Ductile iron pipe.

DIPRA member companies, which together represent 650 years of experience in applied research and manufacturing, are:

- AMERICAN Ductile Iron Pipe
- Canada Pipe Company, Ltd.
- McWane Ductile
- U.S. Pipe

## Table of Contents

<b>Introduction</b>	<b>Page 5</b>
<b>Chapter 1 - Receiving and Handling</b>	<b>Page 8</b>
<b>Chapter 2 - The Trench</b>	<b>Page 18</b>
<b>Chapter 3 - Pipe Installation</b>	<b>Page 42</b>
<b>Chapter 4 - Valves</b>	<b>Page 64</b>
<b>Chapter 5 - Restraining Thrusts</b>	<b>Page 70</b>
<b>Chapter 6 - Backfilling</b>	<b>Page 78</b>
<b>Chapter 7 - Flushing, Testing, and Disinfecting</b>	<b>Page 80</b>
<b>Chapter 8 - Service Taps</b>	<b>Page 91</b>
<b>Chapter 9 - Special Installations</b>	<b>Page 97</b>
<b>Chapter 10 - Useful Information</b>	<b>Page 104</b>
<b>Index</b>	<b>Page 130</b>

Copyright© 2021, 2016, 2015, 2007, 2006, 2003, 2001, 2000, 1997, 1994 by Ductile Iron Pipe Research Association.

This publication, or parts thereof, may not be reproduced in any form without permission of the publishers.

ISBN 978-0-9642194-2-7

Revised 09-21

## Tables

1. Suggested Maximum Allowable Stacking Heights for Ductile Iron Pipe Page 15
2. Suggested Trench Width Page 24
3. Minimum Flattened Polyethylene Tube Widths for Push-on Joint Pipe Page 40
4. Mechanical Joint Bolt Torque Page 54
5. Maximum Deflection Full Length Pipe, Push-on Joint Pipe Page 56
6. Maximum Deflection Full Length Pipe, Mechanical Joint Pipe and Fittings Page 57
7. Resultant Thrust at Fittings at 100 psi Water Pressure Page 70
8. Soil Bearing Capacities Page 72
9. Required Flow and Openings to Flush Pipelines Page 81
10. Hydrostatic Testing Allowance per 1,000 Feet of Pipeline-gph Page 82
11. Weight of Calcium Hypochlorite Granules to be Placed at Beginning of Main and at Each 500-foot Interval Page 86
12. Number of 5-gram Calcium Hypochlorite Tablets Required for Dose of 25 mg/L Page 87

13. Chlorine Required to Produce  
25 mg/L Concentration in 100 Feet  
of Pipe by Diameter Page 88
14. Maximum Recommended Direct  
Tap Size for 3- through 24-inch  
Ductile Iron Pipe Page 95
15. Linear Expansion of  
Ductile Iron Pipe—Inches Page 107
16. Conversion Factors Page 108
17. Standard Dimensions and Weights  
of Push-on Joint Ductile Iron Pipe Page 114
18. Standard Dimensions and Weights  
of Mechanical Joint Ductile Iron Pipe Page 118
19. Pipe Thicknesses Required for  
Different Tap Sizes  
*per ANSI/ASME B1.20.1* Page 120
20. Pipe Thicknesses Required for  
Different Tap Sizes  
*per AWWA C800* Page 124
21. Nomograph for Pipe Size, Head Loss,  
and Discharge for Ductile Iron Pipe Page 128

## Introduction

Ductile iron is an improvement to the cast irons that have served the water industry with distinction through the centuries. The first Ductile iron pipe was produced experimentally in 1948. Minor but significant changes in the chemistry and processing of cast iron result in physical differences at the microstructure level, producing a material with vastly improved fracture toughness and ductility. The resulting Ductile iron pipe is substantially more resistant to damage from impact or concentrated stress.

Although both materials are classified as cast irons, in today's terminology, the older material is identified as gray iron and the newer material as ductile iron. During the solidification stage of the casting process, the carbon, sometimes called graphite, comes out of solution and collects in numerous small pools. The shape of these pools of carbon is a major factor in the mechanical properties of the material.

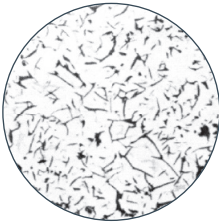

Gray Iron

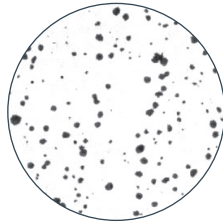

Ductile Iron

*These photomicrographs compare the microstructures of gray iron and ductile iron. Note the relative continuity of the matrix exhibited by the ductile iron (right).*

In gray iron, these pools are described as being in the form of a flake. That is, they are generally in an elongated, flat form ending in sharp points. The carbon content and flake graphite form give gray iron good machinability and corrosion-resistant properties. The flakes, however, break up the continuity of the metal, and the sharp points are stress concentrators at the microscopic level. Both of these characteristics limit the ductility and tensile properties of the material.

In ductile iron, the majority of the pools of graphite are in the form of spheroids. This distinctive shape significantly reduces the occurrence of points of stress concentration. Changing the carbon structure from flake to spheroidal form and reducing the phosphorus content results in an exceptionally strong material with good machinability, high-impact and corrosion resistance, and excellent beam strength. For these reasons, ductile Iron is an ideal material for transporting water and other liquids.

Proper installation procedures will add immeasurably to the long and useful life of Ductile iron pipe. Therefore, the Ductile Iron Pipe Research Association (DIPRA) has prepared this guide to assist water utilities, contractors, consulting engineers, and others concerned with the installation of Ductile iron pipe. While it covers installation procedures, maintenance, and recommended safety precautions, it is intended only as a guide, and does not replace appropriate specifications and standards.

Detailed standards for Ductile iron pipe, fittings, and appurtenances are available from the American Water Works Association (AWWA). Standard ANSI/AWWA C600, “Installation of Ductile Iron Mains and Their Appurtenances,” includes much of the information outlined in this guide. AWWA Manual M41 on Ductile Iron Pipe and Fittings is also available from AWWA.

*Note: Tables are presented in U.S. customary units. Metric conversion factors are provided in Chapter 10 for your convenience.*



# Chapter 1

## Receiving and Handling

**1.1 Inspection:** Ductile iron pipe is normally shipped from foundries by rail or truck and, less frequently, by barge. It is rugged and will withstand the shocks and stresses normally encountered during transit. The purchaser may make arrangements with the manufacturer for inspection and acceptance of Ductile iron pipe and appurtenances at the manufacturer's plant. When the pipe arrives at its destination,



regardless of the method of transportation, it should be carefully inspected for damage that may have occurred in transit.

Material found to be defective due to manufacture, or damaged

during shipment should be recorded on the delivery receipt or similar document by the carrier's agent. In addition, each shipment should be verified against shipping papers for any shortages or errors, which should also be recorded on the bill of lading or similar document by the carrier's agent. The purchaser may make tests specified in the applicable AWWA standard to ensure compliance with the standard. The manufacturer or contractor is responsible for replacing defective materials.

Cement-mortar linings may be repaired in the field in accordance with ANSI/AWWA C104/A21.4. Defective or damaged areas of linings

may be patched by cutting out the defective or damaged lining to the metal so that the edges of the lining not removed are perpendicular to the pipe wall or slightly undercut. A stiff mortar, prepared in accordance with ANSI/AWWA C104/A21.4, is then applied to the thoroughly wetted cutout area and troweled smooth with the adjoining lining. After any surface water has evaporated, but while the patch is still moist, it should be cured as specified in ANSI/AWWA C104/A21.4.

Unless otherwise specified, Ductile iron pipe is furnished with a standard coating approximately 1-mil thick per ANSI/AWWA C151/ A21.51. The primary purpose of the coating is to minimize atmospheric oxidation for aesthetic reasons.

**1.2 Shipments:** Most pipe shipped by DIPRA member companies is in the form of prepackaged bundles, which are placed as a unit on a truck or railcar. Depending on the number of tiers in a package, the bundles may be stacked two or more high. The pipe can also be loaded tier by tier. Loads on trucks or trailers are usually secured to the bed by nylon straps. Loads on railcars are almost universally fastened to the car with steel strapping.

In making up tiers of pipe, whether for packages or direct loading on the transportation unit, every other pipe is normally turned so that, at each end of the tier, the pipe is alternately bell end to plain end. Adjacent pipes touch full length except for the short extension of the bells beyond the plain ends. Bells on pipe of one tier should not touch or interfere with bells or barrels in the tier above or below.

The purchaser is usually consulted with regard to the method of transportation to facilitate plans for unloading, either at a central location for later transfer to the job site or by stringing the pipe along the right-of-way.

Pipe to be moved a short distance at the work site, as from one side of the street to the other, should be rolled by hand or lifted and moved by machine. It should not be pushed or dragged.

**1.3 Unloading:** Pipe loads often have warning labels attached to the blocking with messages similar to the following:

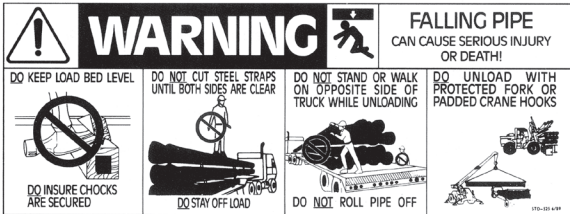

Important points of caution concerning the receiving and unloading of pipe are:

1. Trucks should be parked on level ground for unloading.
2. Before release of chains, cables, or strapping, an inspection should be made to ensure that chock blocks are securely in place on both ends of every support timber. Where chock blocks are missing or inadequately fastened, corrections should be made. Under no circumstances should chocks be removed while there is any possibility of pipe rolling out of control and causing damage or injury.

3. Personnel should never remain on, in front of, or alongside a load of pipe after the restraints have been removed.
4. Steel banding should be cut with a long-handled bolt or strap cutter. Straps should not be cut with an axe, chisel, or other tool likely to damage the pipe or its lining or cause personal injury. Workmen and any other personnel in the area should wear and use appropriate safety equipment.
5. Pipe should never be rolled off the carrier or dropped on old tires or other cushions. A forklift or crane should be used for unloading. Precautions should be taken to prevent the pipe from rolling or shifting during unloading. Personnel not directly involved in the unloading operation should stand clear.



6. When not unloaded by forklift, pipe is usually lifted from railcars using a cable arrangement with a large, padded hook for each end of the pipe or by pipe tongs. If the pipe is shipped on wood spacers, loop slings can be used for unloading so that the loops can be placed easily around the center of the pipe. A crane may be used to lift the pipe from the railcar to trucks for delivery to the trench site or stockpile. The crane operator should use care not to strike the pipe against the side of the car or against another pipe. When pipe is transported from the railhead to the trench site by truck, the pipe should be safely reloaded, secured, and handled as previously described.





**1.4 Slings:** A variety of slings are available for handling pipe. Nylon slings, with an appropriate lifting capacity, are particularly well-suited for lifting Ductile iron pipe and appurtenances.

**1.5 Hooks:** Hooks used in the ends of pipe for unloading purposes should fit both the plain and bell ends without damaging or binding on the metal. The hooks are usually fabricated of one-inch or larger round bar stock, depending on the pipe size.

Hooks should be padded, and care should be taken not to damage the interior lining and coating of the pipe, fittings, or valve and hydrant products.

**1.6 Pipe Tongs:** Several patented lifting tongs or clamp devices are available that release the pipe automatically when the hoist cable is slackened. Some clamps will fit the outside diameter of two or three different sizes of pipe, while other styles require a different clamp for each size of pipe being handled. Care should be taken when using pipe tongs near trenches that

have bracing protruding above the ground. If the pipe comes in contact with the bracing, the pipe tongs may release the pipe prematurely. During freezing weather, care should also be taken to ensure that the pipe-holding pads on the tong are kept ice-free to avoid pipe slippage, which could result in injury.

All lifting devices should be inspected, repaired, and replaced on a timely basis.

**1.7 Special Exterior Coatings:** When pipe is furnished with special exterior coatings, handling devices such as slings, hooks, or tongs should be padded to prevent damage to the coatings. In addition, the coatings should be inspected for damage once the handling device is removed. For polyethylene encased pipe, damage should be repaired with



polyethylene tape or by taping a section of polyethylene film over the damaged area.

**1.8 Stacking:**

Pipe stored for an extended period of time should not be stacked higher than indicated in

the following table. Timbers should be used to keep bottom tiers off the ground and to help keep dirt and debris out of the pipe. Pipe on succeeding tiers should be alternated bell end to plain end. At least two rows of timbers should be placed between tiers with chocks nailed at each end to prevent movement of the pipe. For safety and convenience, each size should be stacked separately.

**Table 1****Suggested Maximum Allowable Stacking Heights For Ductile Iron Pipe**

Pipe Size (inches)	Number of Tiers	Pipe Size (inches)	Number of Tiers
3	18*	20	6
4	16*	24	5
6	13*	30	4
8	11*	36	4
10	10*	42	3
12	9*	48	3
14	8*	54	3
16	7	60	3
18	6	64	3

*\*Stacking height limited to approximately 12 feet for safety and handling ease.*

**1.9 Fittings and Accessories:** Fittings, valves, and fire hydrants should be drained and stored where they will not be damaged by freezing and should be handled in such a manner as to prevent damage. Small accessories, such as rubber gaskets, bolts, disinfecting chemicals, polyethylene encasement, and joint lubricants that are necessary for water main installation should be stored in a mobile tool house or supply shed until used. Lubricant for rubber-gasketed joints is delivered in sealed containers and should be kept sanitary to make main disinfection easier.

**1.10 Gaskets:** Because gaskets supplied for typical water pipe projects using push-on or mechanical joints are made of synthetic rubber,



they should be stored in a cool location out of direct sunlight and should have no contact with petroleum products. Gaskets stored in this way will typically last for years in inventory and should be used on a first-in, first-out basis. Before use, gaskets should be checked for cracking or deterioration by looping the gasket in the manner done when a gasket is being installed. In cold weather, the gaskets should be warmed to facilitate installation. SBR (Styrene Butadiene) rubber gaskets are standard for normal service temperatures of up to 120°F for mechanical joints and 150°F for push-on joints. Special gaskets are available for higher temperatures and other special service requirements.

Gaskets for the various types of push-on joints are not interchangeable but are made specifically for a particular manufacturer's joint. Care should be exercised to use the proper gasket when assembling push-on joint Ductile iron pipe. The manufacturer's trade name or trademark, pipe size, and other pertinent information are marked on each gasket for easy identification.

Ductile iron pipe does not deteriorate and is impermeable when subjected to hydrocarbons. With a Ductile iron pipe system, only the gasketed joints may be subject to permeation. However, due to the relatively small contact area between the gasket and potable water, permeation through Ductile iron pipe gasketed joints is not likely to be a significant source of contamination unless the gasket is exposed to neat organic chemicals for long periods of time. Some gasket materials resist permeation and

degradation from hydrocarbons better than others. While tests on other gasket materials show promise, the results to date indicate that fluorocarbon rubber gaskets are the most resistant to permeation. Gaskets of this material are available for use with Ductile iron pipelines installed in areas contaminated by or susceptible to contamination by hydrocarbons.

**1.11 Delivery at Trench Site:** To avoid unnecessary handling, the pipe and appurtenances should be placed as close as possible to the position they will occupy in the finished pipeline. The pipe is normally placed close to the trench on the side opposite the spoil bank. Pipe is normally strung along the trench with bells facing in the same direction. Pipe should be placed along the job site in locations to prevent runoff from rain events entering the pipe prior to use. It is helpful, where practical, to string pipes with ends (particularly bells) elevated off the ground to minimize cleaning required prior to installation.



## Chapter 2 The Trench

**2.1 Pre-construction Planning:** Prior to installation, consider making a video record along the job site. The water main should be installed to the line and grade established by the engineer. This precaution is usually required in metropolitan areas where sub-surface utilities located in the streets must be avoided by going over, under, or around them. The engineer establishes the location of these structures and provides a detailed plan and profile.

The pipe laying foreman should plan excavation work, equipment, and manpower to fit the plans provided as well as carefully investigate the construction site before moving equipment to the site.

When equipment space is limited, small trenchers may be needed. Some urban streets and alleys may be so narrow that hand work or a small backhoe or trenching machine may be required to install the pipeline.

The reverse of these conditions is found on cross-country installations where pipe may be strung for a long distance ahead of the actual excavating operation. More trench can be opened ahead of the pipe-laying crew, and safety conditions are more easily controlled. Work crews can be organized on the assumption that long stretches of main will be installed each day. If lengths of pipe and fittings have not been strung along the route in advance, plans should be made for their delivery as needed.

**2.2 Trees, Shrubs, and Lawns:** Written instructions should be obtained from the engineer for the destruction, removal, or preservation of trees, shrubs, lawns, and fences along the pipeline. Often it is possible to tunnel under large trees, but shrubs, bushes, and small trees have to be removed to a storage lot and heeled in or destroyed and later replaced.

**2.3 Other Utilities:** Pre-construction conferences should be held on major construction projects. Before city streets are excavated, all utilities should be notified in writing so their structures can be located and staked out on the right-of-way. Some streets and highways are honeycombed with pipes, sewers, conduits, power cables, and telephone ducts. Call 811 anywhere in the USA to arrange for utility locates in advance. No excavation should begin before clearance is obtained from all utilities.



When unforeseen obstructions that require alteration of the plans are encountered, the specifications may require the owner to approve the changes or arrange for removal, relocation, or reconstruction of the obstructions. These precautions save the owner, engineers, and work crew time and money. For example, a ruptured gas main caused by the teeth of a backhoe can require the evacuation of residents for several city blocks while the repair is being completed. Repair of damaged underground telephone cables is also expensive.

**When excavating, extreme care should be exercised to avoid destruction of other utilities' property or interruption of their services.**

**2.4 Gas Services:** If excavation equipment damages a gas service pipe, the gas utility should be notified immediately. Repair of a gas service pipe should not be attempted without the supervision of an authorized employee of the gas company. If there are unlocated gas services along the route, a gas service agent should be present at the job site to make any necessary repairs. Visible breaks or damage to gas service pipe is usually in the open trench and is easily repaired, but experience has shown that the jerk or blow of an excavating bucket can pull a joint or coupling loose between the main and the house. This may cause a gas leak, which could result in an explosion. An experienced gas service agent should supervise all repairs.

**2.5 House Sewers:** House sewers at the same elevation as the water main often

create a problem. In this situation, it is usually easier to lower the grade of the water main slightly to avoid the sewers. Care must be taken during excavation not to damage house sewers. If damage occurs, a temporary sewer must be installed as soon as possible. The job supervisor should be familiar with local and state regulations specifying the minimum space requirements between water mains and sewers.

All house sewers must be in as good condition after completion of the water main as they were before work started.

**2.6 Trench Excavation:** In most cases, engineers require that pipe be installed with a specific minimum earth cover, which usually depends on the frost line in northern states and on surface load conditions in the South. Each utility or municipality has established practices for this part of the excavation work. In addition, the Occupational Safety and Health Administration (“OSHA”) regulates the need to support trench walls during excavation. In part, they require a trained “Competent Person” who is responsible for the safety of the site and personnel. Based on trench depth and type of soils encountered, they will determine the need for trench wall support and/or sloping. Some soils will stand up well with minimal support while other soils require heavy shoring. Excavation must conform with all federal, state, and local regulations.

Pavement removal is also part of trench excavation. Pavement should be broken in straight lines using appropriate tools and methods.

A minimum cover of 2.5 to 3 feet is generally desirable for water mains to provide a substantial cushion to absorb shock caused by traffic. In northern states with severe frost conditions, pipe is often laid under as much as 8 feet or more of earth cover.

**2.7 Trench Bottom:** The trench bottom should be true and even to give the barrel of the pipe soil support for its full length. Soft subgrade may prove a problem in swampy areas or in loose sand. The trench bottom can be improved by adding crushed stone up to 2 inches in diameter. The stones should be compacted and, if necessary, additional stone added to bring the trench bottom up to proper grade line. Bumping the pipe with the backhoe bucket in order to obtain grade is discouraged due to the possibility of such practice causing damage to the pipe and/or lining. In extreme cases, it may be necessary to drive piling and use cross bracing or clamp the pipe to pile caps to maintain line and grade. Appropriate thickness design procedures for [pipe on supports](#) should be used in this instance.



**2.8 Bell Holes:** Holes for pipe bells should be provided at each joint but should be no larger than necessary for joint assembly (to include achieving the required overlaps for polyethylene encasement, where specified) and assurance that the pipe barrel will lie flat on the trench bottom. Push-on type joints require only a minimum depression for bell holes. Pipe should normally be laid by installing the spigot (plain end) of the pipe into the previously laid bell. On occasion it may be necessary to lay pipe backward (bell into previously laid spigot end). This practice is normally not recommended due to the fact that larger bell holes are generally required and result in a greater need to provide soil support for the new bell ends during initial backfill.

**2.9 Trench Width:** The trench must be wide enough to permit proper installation of the pipe and to allow room to assemble joints and tamp backfill around the pipe. The width is governed by size of pipe, type of soil, and type of excavating equipment. The following table will serve as a guide for trench width:



**Table 2**  
**Suggested Trench Width**

Nominal Pipe Size (inches)	Trench Width (inches)	Nominal Pipe Size (inches)	Trench Width (inches)
3	27	20	44
4	28	24	48
6	30	30	54
8	32	36	60
10	34	42	66
12	36	48	72
14	38	54	78
16	40	60	84
18	42	64	88

**2.10 Rock Excavation:** Rock must be excavated so that it will not be closer than 6 inches to the bottom and sides of the pipe for diameters up to 24 inches and no closer than 9 inches for diameters 30 inches or larger. When excavation is complete, a bed of sand, crushed stone, or earth free from stones or large clods should be placed on the bottom of the trench and leveled and tamped to the above-mentioned depths. A straightedge can be used to check the bottom of the trench to detect high points of rock that may protrude through the cushion.

The word “rock” also applies to large gravel formations where loose cobbles are more than 8 inches in diameter. These cobbles should be removed from the trench and excluded from the backfill. This same practice should be followed if the trench excavation

passes through piles of abandoned masonry, large pieces of concrete, or other debris. The pipe should not be allowed to rest on masonry walls, piers, foundations, or other unyielding subterranean structures that may be encountered in the excavation. Such obstacles should be removed to the previously mentioned depths below the pipe, and a cushion of suitable material should be provided. Likewise, all temporary pipe support structures, including timbers, should be removed prior to backfilling.



**2.11 Blasting:** Large rocks, foundations, and piers may require blasting to remove them from the trench. For the safety of pipeline crew, blasting operations should proceed well ahead of the crew and should be performed only by licensed personnel. The trench should be covered with a weighted protective mat before the charges are ignited, and pipe should be protected from falling rock and debris.

Trenches that are blasted in rock must be deeper and wider than those in good soil conditions to allow space for the placement of cushioning material around and under the pipe.

## **Local regulations usually govern blasting, and a permit may be required.**

**2.12 Barricades and Safety:** Public safety must be considered at all times. Excavated material from the trench should be piled on the street side of the main, forming a barrier to keep vehicles out of the trench. If excavated material can't be used, barricades should be positioned and moved along as the work progresses. Adequate construction signs, guards, flashing warning lights, and flagmen should also be available to protect the public. Loose excavated material should be removed, and sidewalks cleaned, as often as possible. Children should be discouraged from playing in work areas. Flares or warning lights should be used at night to make excavated material, pipe, and other appurtenances visible.

Wooden walkways at least 4 feet wide with side guard fences should be provided wherever trenching destroys normal pedestrian sidewalks. State or local authorities usually require compliance with established safety provisions.

**2.13 Shoring:** In addition to public safety considerations, safety precautions must be observed by personnel at the job site. The need for shoring depends on the nature of the soil and depth of the trench. In addition to OSHA requirements, many cities, states, and federal agencies have published safety regulations concerning shoring requirements. Sand, loosely

bound clays, and loam are the soil types most likely to cave and slide in on workers. Many clays tend to split in a vertical plane and fall into the trench. The loads adjacent to the open trench imposed by excavated material and the use of heavy equipment will also decrease the stability of the trench walls.

In deep trenches, an engineer should design shoring to properly withstand the horizontal earth load. After pipe is installed, this shoring can be removed and advanced for reuse.

### **2.14 Soil Movement and Expansive Soil:**

Some dense clay soils expand and shrink when subjected to wetting and drying conditions. Cracks form during dry periods, often to great depths. When wet conditions return, the clay soil absorbs moisture and expands, exerting swell pressures as high as 17,500 pounds per square foot (psf). Because of its exceptional strength and flexibility, Ductile iron pipe is often recommended for installations in areas with expansive soils.





**2.15 Corrosive Soil:** Although the majority of U.S. soils are not corrosive to Ductile iron pipe, certain soil environments, including landfill areas, swamps, marshes, alkaline soils, cinder beds, and polluted river bottoms, are considered potentially corrosive to iron pipe. Because of its installation and maintenance requirements, cathodic protection of Ductile iron pipe should be used only after consideration of all aspects of its use, including the need for routine testing and maintenance of the system. Moreover, because corrosive soil can leach through select backfill, such as sand and limestone, the use of select backfill offers only temporary protection against corrosion.

DIPRA has conducted research in evaluating soils for potentially corrosive characteristics and in developing procedures for protecting Ductile iron pipe against aggressive soils since the 1920s. In 1964, CIPRA (now DIPRA) instituted a 10-point soil evaluation procedure for identifying corrosive soils that is included in the Appendix to the ANSI/AWWA C105/A21.5 Standard. More recently, to better serve the water and wastewater industries, DIPRA

and Corrpro Companies, Inc. tapped their extensive knowledge and experience to jointly develop a practical, cost-effective model that provides appropriate recommendations for corrosion control. The result is the Design Decision Model (DDM<sup>®</sup>) that both DIPRA and Corrpro use as an engineering tool to help ensure the longevity that has become the benchmark for ductile iron transmission and distribution pipeline projects. The DDM<sup>®</sup> is an extension of the 10-point soil evaluation procedure and its development is not intended to invalidate the 10-point system. Unlike the 10-point system, which addresses the likelihood of corrosion, the DDM<sup>®</sup> is a two-dimensional risk-based model that balances the likelihood of a corrosion-related problem against the consequences of a failure in determining an appropriate mitigation strategy. The 10-point system is an accurate and dependable method of evaluating soils, however, the DDM<sup>®</sup> provides a more comprehensive approach that offers solutions tailored to the particulars of a proposed pipeline project. For example, the DDM<sup>®</sup> recommendations include considerations of the practical differences between distribution system pipes and transmission mains.

### **2.16 V-Bio Enhanced Polyethylene:**

For most soils considered corrosive to ductile iron, encasing the pipe in loose polyethylene provides an effective and economic method of protection. However, beginning in 2013, DIPRA began to offer a new polyethylene film that has been enhanced with the infusion of a corrosion inhibitor and an anti-microbial component. This new product, V-Bio<sup>®</sup> enhanced polyethylene, takes advantage of co-extrusion technologies in the manufacture of polyethylene films to infuse

these additives into the innermost surface of the polyethylene. Based on more than a decade of research in test sites and on operating pipelines, V-Bio® enhanced polyethylene is a betterment to an already proven method of mitigation against aggressive soil environments and is the recommended film to be used for the protection of Ductile iron pipe. For any ductile iron installation requiring V-Bio® enhanced polyethylene encasement, the encasement should be installed in accordance with ANSI/AWWA C105/A21.5.

**2.17 Metallized Zinc Coatings:** The Ductile iron pipe on a given project may be provided with a metallized zinc coating, which is specified with V-Bio® enhanced polyethylene for the most aggressive environments. From an installation standpoint, there is no difference in the handling of zinc-coated Ductile iron pipe compared to the standard shop coating. The pipe is assembled the same way and has the same deflection capability. Moreover, it can also be cut in the field, if need be, to facilitate installation of the pipeline.

Although the polyethylene encasement should prevent contact between the pipe and surrounding backfill and bedding material, it is not intended to be completely airtight or watertight. Care should be taken to prevent soil or bedding material from becoming trapped between the pipe and the polyethylene.

The polyethylene film should be fitted to the contour of the pipe to affect a snug encasement with minimum space between the polyethylene and the pipe. Sufficient slack should be provided in contouring to prevent stretching

the polyethylene when bridging irregular surfaces, such as bell-spigot interfaces, bolted joints, or fittings, and to prevent damage to the encasement during backfilling operations. Overlaps and ends should be secured with adhesive tape or plastic tie straps.

For installation below the water table or in areas subject to tidal actions, it is recommended that both ends of the encasement be sealed as thoroughly as possible with adhesive tape or tightly applied plastic tie straps at the joint overlap. It is also recommended that circumferential wraps of tape or plastic tie straps be placed at 2-foot intervals along the barrel of the pipe to help minimize the space between the polyethylene and the pipe. If the environment proves too wet for regular tape to be used, a marine grade tape should be specified.

As with all protection methods, proper installation is vital to the success of V-Bio<sup>®</sup> enhanced polyethylene encasement. However, the actual installation sequence is less important than the quality and care taken during installation and subsequent tapping operations (see Section 8.1 of this guide).



## ANSI/AWWA C105/A21.5 Installation Methods



### Modified Method A

This is a modification of Method A, which uses one length of polyethylene tube for each length of pipe. In this modified method, one end of the tube is secured to the spigot directly behind the insertion line prior to making the joint.

After assembly of the joint, the tape should be as close to the face of the bell as possible but not so close as to interfere with the gasket when the joint is made. The 12-inch overlap is achieved when bringing the remaining film over the joint from the previous length of pipe.



### Method A

In this method one length of V-Bio<sup>®</sup> enhanced polyethylene tube, overlapped at the joints, is used for each length of pipe.



## Method B

A V-Bio® enhanced polyethylene tube is used for the barrel of the pipe and separate pieces of the enhanced polyethylene tube or sheet for the joints.

*Note: Method B is not recommended for bolted-type points unless an additional layer of polyethylene is provided over the joint area as in Methods A and C.*



## Method C

Each section of pipe is completely wrapped with a flat sheet of V-Bio® enhanced polyethylene.

## Modified Method A: Step-by-step Installation Guide

Although ANSI/AWWA C105/A21.5 includes four different methods of installing polyethylene sleeving, most utilities and contractors prefer to use some form of Method A. Two popular forms are explained in detail below.

## Modified Method A: Normal Dry Trench Conditions

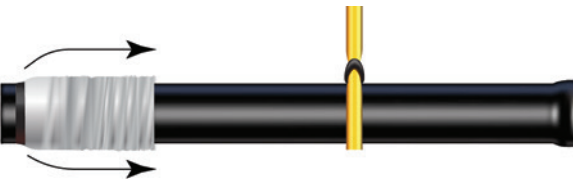

## Step 1.

Cut a section of polyethylene tube approximately one foot longer than the pipe section. Remove all lumps of clay, mud, cinders, or other material that might have accumulated on the pipe surface during storage. Slip the polyethylene tube around the pipe, starting at the spigot end. Bunch the tube accordion fashion on the end of the pipe. Pull back the overhanging end of the tube and circumferentially tape it to the barrel of the pipe outside of the insertion line, approximately 12 inches from the spigot end. After assembly of the joint, the tape should be as close to the face of the bell as possible but not so close to the spigot end that it interferes with the gasket.

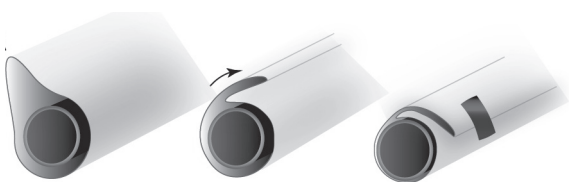

## Step 2.

Take up the slack in the tube along the barrel of the pipe to make a snug fit. Fold the excess polyethylene back over the top of the pipe and use pieces of tape across the fold to securely hold it. Because the advantages offered by V-Bio<sup>®</sup> enhanced polyethylene are maximized by ensuring good contact between the film and the pipe surface, this step is extremely important to avoid sagging of the film at the bottom of the pipe.



### Step 3.

Dig a shallow bell hole in the trench bottom at the joint location to facilitate installation of the polyethylene tube. Lower the pipe into the trench and make up the pipe joint with the preceding section of pipe.

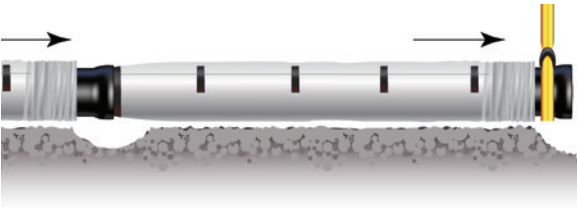

### Step 4.

Move the sling to the bell end of the pipe and lift the pipe slightly to provide enough clearance to easily slide the tube over the remaining barrel of the pipe. Snugly fold over the excess wrap using tape to hold it in place. Note: Make sure that no dirt or other bedding material becomes trapped between the wrap and the pipe.

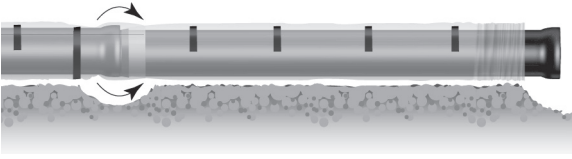

### Step 5.

Secure the polyethylene in place behind the preceding bell by using a circumferential wrap of tape. Make the overlap of the polyethylene tube by pulling back the bunched polyethylene from the preceding length of pipe and ensure there is at least a 12-inch overlap.

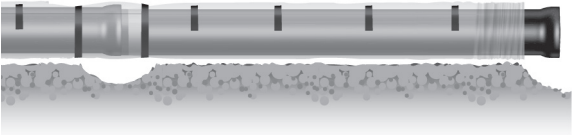

### Step 6.

Place another circumferential wrap of tape on the overlapping polyethylene, securing it to the spigot side of the joint.

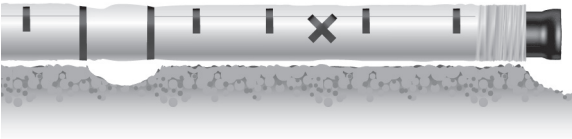

### Step 7.

Repair all small rips, tears, or other tube damage with adhesive tape. If the polyethylene is badly damaged, repair the damaged area with a sheet of V-Bio<sup>®</sup> enhanced polyethylene and seal the edges of the repair with adhesive tape.

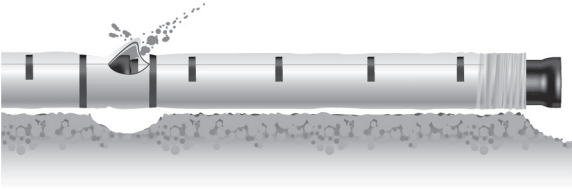

### Step 8.

Carefully backfill the trench according to the procedures in ANSI/AWWA C600 Standard. To prevent damage during backfilling, allow adequate slack in the tube at the joint. Backfill should be free of cinders, rocks, boulders, nails, sticks, or other materials that might damage the polyethylene. Avoid damaging the polyethylene when using tamping devices.

### Alternate Modified Method A: Wet Trench Conditions

In wet, sloppy trench conditions, the pipe should be completely covered by the polyethylene tube before it is lowered into the trench. This alternate method is illustrated below.

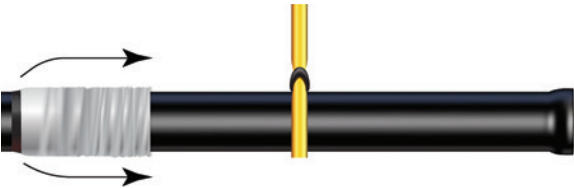

### Step 1.

As with the dry trench method, cut a section of V-Bio® enhanced polyethylene approximately one foot longer than the pipe section. Remove all lumps of clay, mud, cinders, or other material that might have accumulated on the pipe surface during storage. Slip the polyethylene

tube around the pipe, starting at the spigot end. Bunch the tube accordion fashion on the end of the pipe. Pull back the overhanging end of the tube and circumferentially tape it to the barrel of the pipe directly behind the insertion line. After assembly of the joint, the tape should be as close to the face of the bell as possible but not so close to the spigot end that it interferes with the gasket.

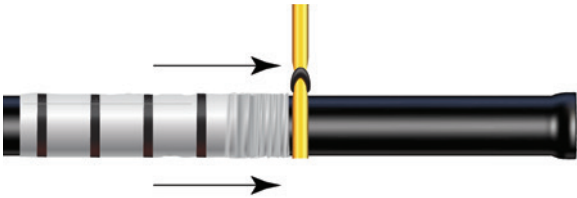

## Step 2.

Take up the slack in the tube along the barrel making a snug fit and fold over the excess polyethylene. Apply circumferential wraps of tape every two feet until you run out of room. This is extremely important to avoid the sagging of the film at the bottom of the pipe.

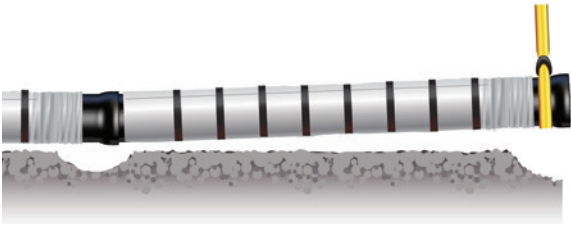

If wet conditions make it difficult for the tape to adhere to the film, a marine grade tape should be used.

### Step 3.

Dig a shallow bell hole in the trench bottom, lower the pipe and make up the joint. Slide the sling to the bell end and lift slightly to provide clearance to slide the encasement to the end. Continue to snugly fold over and tape at 2-foot intervals to secure the polyethylene.

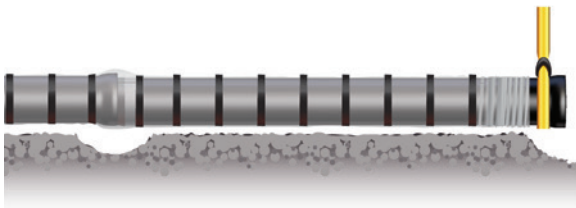

### Step 4.

Make the overlap of the enhanced polyethylene tube by pulling back the bunched polyethylene from the preceding length of pipe and ensure there is at least a 12-inch overlap. Secure the polyethylene with a circumferential wrap of tape at the overlap and behind the preceding bell.

### Step 5.

Repair any damage to the polyethylene and backfill according to ANSI/AWWA C600 as described in Steps 7 and 8 of Modified Method A.

If you have any problems or questions about installing polyethylene encasement, contact DIPRA or one of its member companies. Also available on DIPRA's website are videos that demonstrate recommended installation methods. They may be found [here](https://www.dipra.org) at [dipra.org](https://www.dipra.org)



**Table 3**

## Minimum Flattened Polyethylene Tube Widths for Push-on Joint\* Pipe

Nominal Pipe Size (inches)	Flat Tube Width (inches)	Nominal Pipe Size (inches)	Flat Tube Width (inches)
3	14	20	41
4	14	24	54
6	16	30	67
8	20	36	81
10	24	42	81
12	27	48	95
14	30	54	108
16	34	60	108
18	37	64	121

*\*Larger tube widths may be required for other types of joints.*

## Installing Pipe with Polyethylene Protection





## Chapter 3 Pipe Installation

**3.1 Standard Laying Conditions:** The trench laying condition is usually specified by the engineer or utility. There are five standard laying conditions described in ANSI/AWWA C150/A21.50.

### Laying Condition

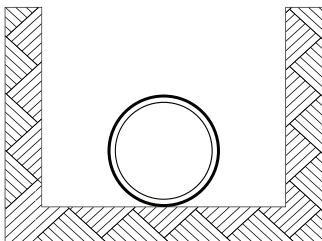

#### Type 1

Flat-bottom trench.† Loose backfill.

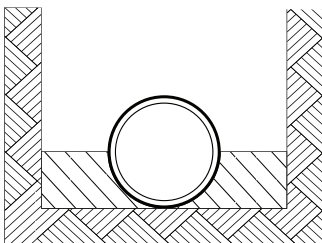

#### Type 2

Flat-bottom trench.† Backfill lightly consolidated to centerline of pipe.

*\*For 14-inch and larger pipe, consideration should be given to the use of laying conditions other than Type 1.*

*† "Flat-bottom" is defined as undisturbed earth.*

## Laying Condition

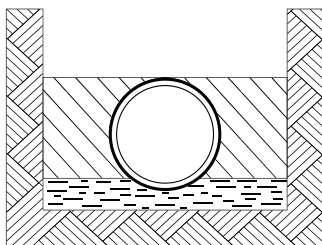

### Type 3

Pipe bedded in 4-inch minimum loose soil.<sup>††</sup>  
Backfill lightly consolidated to top of pipe.

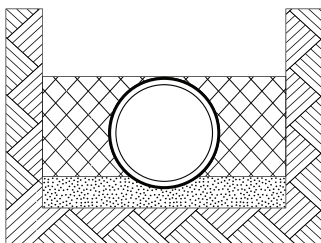

### Type 4

Pipe bedded in sand, gravel, or crushed stone to depth of 1/8 pipe diameter, 4-inch minimum. Backfill compacted to top of pipe. (Approximately 80 percent Standard Proctor, AASHTO T-99)<sup>\*\*</sup>

<sup>††</sup>Loose soil or select material is defined as "native soil excavated from the trench, free of rocks, foreign materials, and frozen earth."

<sup>\*\*</sup>AASHTO T-99 "Standard Method of Test for the Moisture-Density Relations of Soils Using a 5.5 lb (2.5 kg) Rammer and a 12 in. (305 mm) Drop." Available from the American Association of State Highway and Transportation Officials, 444 N. Capital St. N.W., Washington, DC 20001.

## Laying Condition

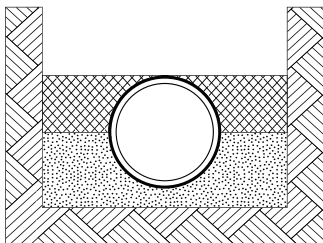

### Type 5

Pipe bedded to its centerline in compacted granular material, 4-inch minimum under pipe. Compacted granular§ or select material<sup>††</sup> to top of pipe. (Approximately 90 percent Standard Proctor, AASHTO T-99)\*\*

*§ Granular materials are defined per the AASHTO Soil Classification System (ASTM D3282) or the Unified Soil Classification System (ASTM D2487), with the exception that gravel bedding/backfill adjacent to the pipe is limited to 2" maximum particle size per ANSI/AWWA C600.*

*<sup>††</sup>Loose soil or select material is defined as "native soil excavated from the trench, free of rocks, foreign materials, and frozen earth."*

*\*\*AASHTO T-99 "Standard Method of Test for the Moisture-Density Relations of Soils Using a 5.5 lb (2.5 kg) Rammer and a 12 in. (305 mm) Drop." Available from the American Association of State Highway and Transportation Officials, 444 N. Capital St. N.W., Washington, DC 20001.*

**3.2 Cleaning Bells and Plain Ends:** To prevent gasket displacement and leaking joints, sand, dirt, excess coating, ice, and other foreign material must be removed from the plain end and the gasket recesses of the bell.

**3.3 Handling Pipe Into Trench:** Before any length of pipe is lowered into the trench, it should be inspected for damage and the inside of the pipe should be inspected for loose dirt and foreign objects such as tools, clothing, etc. If mud and trench water have been permitted to stand or flow through the pipe, the inside should be scrubbed with a strong chlorine solution and washed or flushed out. This precaution will save time and expense when disinfecting the completed water main.

Pipe must be handled with power equipment and should be lowered into the trench with pipe tongs or slings. Under no condition should it be pushed off the bank and allowed to fall into the trench.

If a cable sling is used around the center of the pipe, a wooden block placed between the pipe and the cable will reduce the likelihood of pipe slippage.

Valves, fittings, and hydrants should be lowered into the trench with a rope or power hoist, depending on their sizes. The rope or sling should not be attached to the valve stem, and under no condition should these appurtenances be dropped or dumped into the trench.



**3.4 Direction of Bells:** Although it is common practice to lay pipe with the bells facing the direction in which work is progressing, it is not mandatory. When the main is being laid downhill, for example, the pipes are occasionally laid with the bells facing uphill for ease of installation. The direction of the bells is not functionally related to the direction of flow

within the main. See Section 2.8, Bell Holes, for additional comments relating to direction of bells.

**3.5 Pipe Plugs:** At times when pipe laying is not in progress, the open ends of the pipe should be closed with a watertight plug or other means approved by the owner. The plug should have a means of venting so that air or water pressure in the pipeline can be released prior to removal of the plug. Care must be taken to prevent pipe flotation if the trench floods.

**3.6 Push-on Joints:** The push-on joint consists of a special bell, plain end, and rubber gasket. The bell is provided with an internal groove in which the appropriate gasket is seated. The plain end is beveled, and the joint is assembled by pushing the plain end into the bell, which compresses the gasket and forms a watertight seal. There are two push-on joint designs available from Ductile iron pipe manufacturers. The bell socket is different for each type of gasket, and the gaskets are not interchangeable.

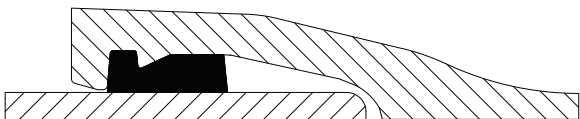

Fastite®

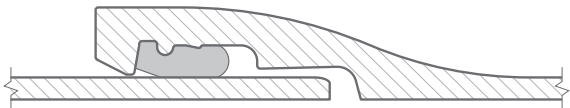

Tyton Joint



The outside diameter of all Ductile iron pipe of the same size, however, is standardized, regardless of the manufacturer. Care must be exercised to make certain that the correct gasket is being used for the joint design being installed and that the gasket faces the proper direction. The following illustrations highlight the steps followed in making up the joint.

When pipe is cut in the field, bevel the plain end with a heavy file, an air-driven grinder, or other suitable device and remove all sharp edges. OSHA regulations do not allow the bevel to be made using the blade of a saw used to cut the pipe. Refer to a shop-manufactured bevel as a guide for proper shape.

Either push-on joint or mechanical joint fittings may be used with push-on joint pipe. The plain end of the pipe is provided with either one or two painted gauge lines that can be used to determine if the plain end has been properly positioned in the bell socket. The pipe manufacturer's instructions regarding the location of these lines after assembly should be followed.

### Push-On Joint Assembly



1. Thoroughly clean the groove and the bell socket of the pipe or fitting; also clean the plain end of the mating pipe or fitting. Using a gasket of the proper design for the joint to

be assembled, make a small loop in the gasket and insert it in the socket. For pipe sizes larger than 20 inches it may be necessary to make two loops in the gasket (6 and 12 o'clock). Make sure the gasket faces the correct direction and that it is properly seated.

*Note: In cold weather, it may be necessary to warm the gasket to facilitate insertion.*



2. Apply lubricant to the exposed surface of the gasket and plain end of the pipe or fitting in accordance with the pipe manufacturer's recommendations. Do not apply lubricant to the bell socket or the surface of the gasket in contact with the bell socket. Lubricant is furnished in sterile containers and every effort should be made to keep it sterile. For underwater or very wet joint assemblies, relatively insoluble underwater joint lubricant is available and should be used.



3. Be sure that the shape/dimensions of the bevel on the plain end is per the manufacturer's recommendations; square or sharp edges may damage or dislodge the gasket and cause a leak. When pipe is cut in the field, bevel the plain end with a heavy

file or grinder to remove all sharp edges. Do not use a saw blade to bevel the plain end. Push the plain end into the bell socket of the mating pipe or fitting, keeping the joint straight while pushing. Make deflection after the joint is assembled.



4. Small pipe can be pushed into the bell socket with a long bar. Large pipe requires additional power, such as a jack, lever puller, or backhoe. The supplier may provide a jack or lever puller on a rental basis. A timber header should be used between the pipe and the jack or backhoe bucket to avoid damage to the pipe.

Several pulling devices are available for large-diameter pipe, each with its own set of directions that should be followed carefully for convenience and smooth operation.

As of 1962, push-on joint pipe is manufactured with a standard outside diameter for each nominal size of pipe. This should be considered when connecting a new push-on joint pipe with an old pit-cast pipe. Pit-cast pipe was manufactured in four classifications – A, B, C, and D – and each usually had a different outside diameter dimension. Existing pipe in the system should be measured to determine whether a

transition coupling or specially sized gasket will be required for connecting pipe of different outside diameters.

**3.7 Mechanical Joints:** The primary use of mechanical joints for Ductile iron pipelines is for fittings and has limited availability in Ductile iron pipe sizes. The mechanical joint has four parts: a flange cast with the bell; a rubber gasket that fits in the bell recess; a gland, or follower ring, to compress the gasket; and tee head bolts and nuts for tightening the joint. Joint assembly is very simple and requires only one tool – an ordinary ratchet wrench.

*Note: The mechanical joint is not a restrained joint and offers no practical resistance against joint separation due to thrust forces. If restrained joints are required, contact your DIPRA member company. (See Section 5.3.0)*

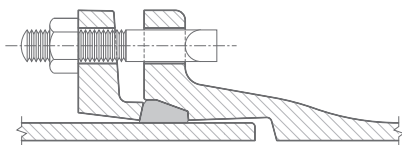

MECHANICAL JOINT

## Mechanical-Joint Assembly

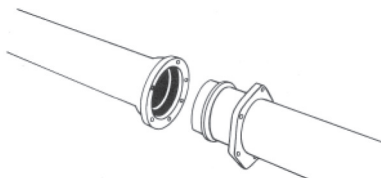

1. Wipe clean the bell recess and the plain end. Brush both the gasket and plain end with soapy water or an approved push-on joint lubricant meeting the requirements of ANSI/AWWA C111/A21.11 immediately before slipping the gasket onto the plain end for joint assembly.

*Note: Lubrication is recommended for proper assembly of all mechanical joints. Place the gland on the plain end with the lip extension toward the plain end, followed by the gasket with the narrow edge of the gasket toward the plain end. Note: In cold weather, it is preferable to warm the gasket to facilitate assembly of the joint.*

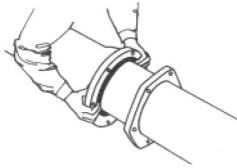

2. Insert the plain end into the socket and press the gasket firmly and evenly into the gasket recess. Keep the joint straight during assembly.



3. Push the gland toward the socket and center it around the plain end with the gland lip against the gasket. Insert bolts and hand tighten nuts. Make deflection after joint assembly but before tightening bolts.

4. Tighten the bolts to the normal range of bolt torque (as indicated in the table below) while constantly maintaining approximately the same distance between the gland and the face of the flange at all points around the socket. This consistency can be accomplished

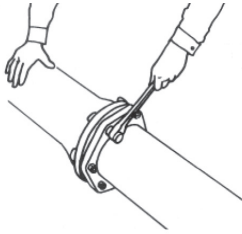

by partially tightening the bottom bolt first, then the top bolt, then the bolts at either side, and finally the remaining bolts. This procedure is known as the “star pattern” for tightening bolts. Repeat the process until all bolts are within the appropriate range of torque. In large sizes (30-inch through 48-inch), five or more repetitions may be required. Joints that have been assembled without proper lubrication and/or inadequate bolt torque are susceptible to leakage.

**Table 4****Mechanical Joint Bolt Torque**

Joint Size (inches)	Bolt Size (inches)	Range of Torque (ft. - lb.)
3	5/8	45-60
4-24	3/4	75-90
30-36	1	100-120
42-48	1-1/4	120-150

*Notes: Centrifugally cast push-on joint and mechanical joint pipe have the same outside diameter for each nominal size. 30- to 64-inch mechanical joints are available on fittings only.*

**3.8 Flanged Joints:** Flanged joints are seldom used for underground water mains except for valves and fittings for large meter settings, valve vaults, and similar installations. This joint is most commonly used for inside piping in pump rooms, filter plants, and sewage treatment plants, and is occasionally used with valves adjacent to fire hydrants. Because of its rigidity, the flanged joint is not recommended where heavy settlement or vibration is likely to occur.

**3.9 Joint Deflection:** It is often necessary to divert the pipeline from a straight line when following the curvature of streets and roads. Both push-on and mechanical joint pipe are well suited to applications where joint deflection is required.

On long radius curves, the trench should be excavated wider than normal to allow for straight line assembly before deflection. Inserting the plain end of a full length of pipe into a bell under deflected conditions is

not recommended and should be avoided if possible. When deflection is necessary, pipe should be assembled in a straight line, both horizontally and vertically, before deflection is made. For mechanical joint pipe, bolts should be hand tightened before the length of pipe is deflected.

## Pipeline Curve Geometry

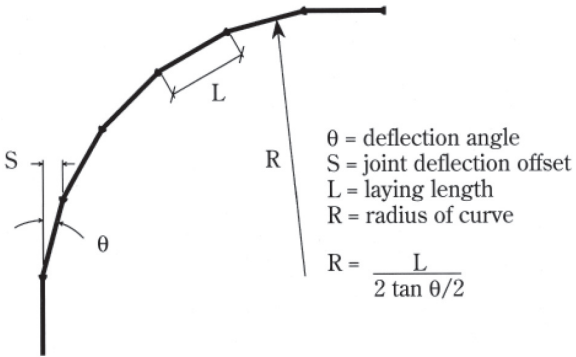



**Table 5****Maximum Deflection Full Length Pipe  
Push-on Joint Pipe**

Nominal Pipe Size (inches)	Deflection Angle - Ø* (degrees)	Max. Offset - S* (inches)		Approximate Radius of Curve - R* Produced by Succession of Joints	
		L*= 18 ft.	L*= 20 ft.	L*= 18 ft.	L*= 20 ft.
3	5	19	21	205	230
4	5	19	21	205	230
6	5	19	21	205	230
8	5	19	21	205	230
10	5	19	21	205	230
12	5	19	21	205	230
14	3	11	12	340	380
16	3	11	12	340	380
18	3	11	12	340	380
20	3	11	12	340	380
24	3	11	12	340	380
30	3	11	12	340	380
36	3	11	12	340	380
42	3	11	12	340	380
48	3	-	12	-	380
54	3	-	12	-	380
60	3	-	12	-	380
64	3	-	12	-	380

*Note: For 14-inch and larger push-on joints, maximum deflection may be larger than shown above. Consult your DIPRA member company.*

*\*See figure on page 55.*

**Table 6****Maximum Deflection Full Length Pipe  
Mechanical Joint Pipe and Fittings\***

Nominal Pipe Size (inches)	Deflection Angle <sup>†</sup> - Ø* (degrees)	Max. Offset - S* (inches)		Approximate Radius of Curve - R* Produced by Succession of Joints	
		L*= 18 ft.	L*= 20 ft.	L*= 18 ft.	L*= 20 ft.
3	8	31	35	125	140
4	8	31	35	125	140
6	7	27	30	145	160
8	5	20	22	195	220
10	5	20	22	195	220
12	5	20	22	195	220
14	3.5	13.5	15	285	320
16	3.5	13.5	15	285	320
18	3	11	12	340	380
20	3	11	12	340	380
24	2	9	10	450	500

Note: Per ANSI/AWWA C111/A21.11, the maximum size for mechanical joint pipe is 24-inches. However, fittings with mechanical joints are available in larger sizes.

<sup>†</sup>Rounded down to nearest half degree.

\*See figure on page 55.

**3.10 Transition Couplings:** Transition couplings and/or gaskets are required for joining ductile iron to different types of pipe such as steel, asbestos-cement, and plastic. When ordering transition couplings or gaskets, you should give the actual outside diameter of both types of pipe. This may require excavation and circumferential measurement of the existing pipes.



**3.11 Cutting Pipe:** Ductile iron pipe can be cut using an abrasive cut-off saw, a rotary wheel cutter, a guillotine pipe saw, a chain saw specifically made to cut Ductile iron pipe, or a milling wheel saw. The pipe can also be cut with an oxyacetylene torch if recommended by the pipe manufacturer.

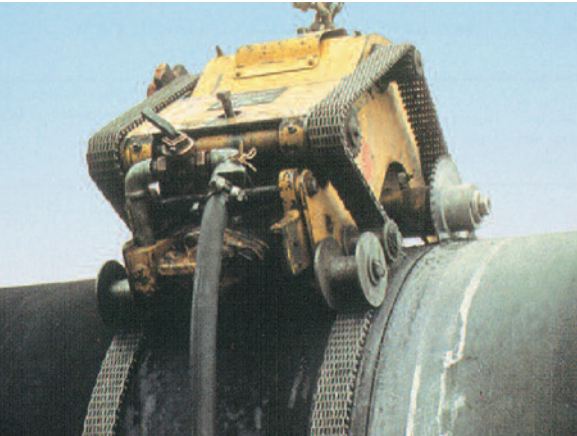

The abrasive cut-off saw is frequently used for “out of trench” cuts on any size pipe. The rotary wheel cutter can be used in or out of the trench for pipe through 30 inches in diameter. The guillotine saw can be used in or out of the trench to cut pipe up to 16 inches in diameter. And the milling wheel saw can be used in or out of the trench for pipe 6 inches in diameter or larger. Each of these cutting tools is available with either electric or air-driven motors.

In addition, special bevel cutters are available to bevel the pipe while cutting with a milling wheel saw and, when equipped with an air-driven motor, can be used to make underwater cuts. If the oxyacetylene torch method of cutting pipe is used, the DIPRA member company must be consulted for recommendations and instructions on cutting its product. The ANSI/ AWWA standards for Ductile iron pipe require factory gauging of the spigot end.

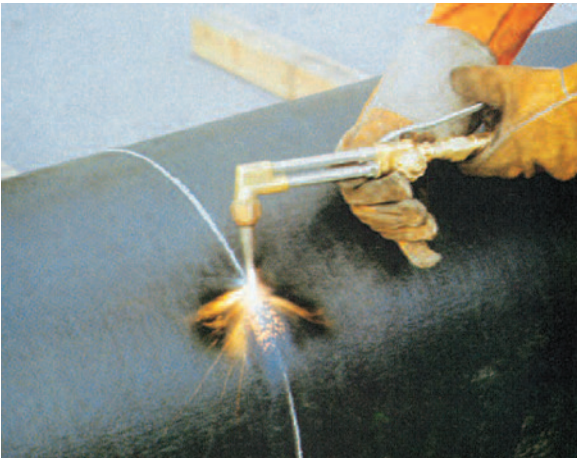

Accordingly, pipe selected for cutting should be field-gauged. A mechanical joint gland inserted over the barrel of the pipe might serve as a convenient indicator for field gauging. When glands are not available, pipe can be selected by measuring with a tape in accordance with the manufacturer's recommendation. Some pipes, especially in the larger diameters, may be out-of-round to the degree that they will need to be rounded after cutting by jacking, being careful not to over jack the pipe, or other methods to facilitate making the joint. This is a normal occurrence and does not in any way affect the serviceability of Ductile iron pipe. Instructions for rounding their pipe products can be obtained from the pipe manufacturers.

Cut ends and rough edges should be ground smooth and, for push-on type connections, the cut end must be beveled slightly. The time required for mechanically cutting Ductile iron pipe with an abrasive cut-off saw is approximately one minute per inch diameter of pipe. For example, 24 minutes would be required to mechanically cut a 24-inch diameter pipe.



### 3.12 Railroad and Highway Crossings:

Water mains are frequently installed under highways and railroads. Because of its inherent toughness and high-impact resistance, ductile iron is an excellent pipe material for this application. In many cases, ductile iron eliminates the need for a protective steel casing pipe. However, existing conditions may dictate the use of a casing and some state and local highway departments and railroads continue to require casing. Although highway department regulations vary from state to state, most railroads use American Railway Engineering Association (A.R.E.A.) regulations. These regulations should be checked, and the necessary permits obtained well in advance of the actual work. Crossings are normally made by boring, jacking, tunneling or by horizontal directional drilling (HDD).



Where casing is required, the Ductile iron pipe is either pushed or pulled through the previously installed casing pipe. The casing pipe should be six to eight inches larger than the outside diameter of the bells on the Ductile iron pipe.

Insulating chocks, skids, or spacers should be placed on or under the Ductile iron pipe to keep the pipe centered in the casing and to prevent damage when installation is made. Care must be exercised to avoid pipe-to-casing contact. End caps or other methods of sealing the casing pipe shall be provided as specified.

Because of its ability to withstand vibrations, either push-on joint or mechanical joint pipe should be used under railroads. Backfill material may be eliminated in the space between the pipe and short culverts. At very long crossings, it is often necessary to partially fill the space between the ductile iron and casing pipe to prevent movement. If sand is used, do not completely fill the space between the pipe and casing, because this practice transmits surface loads to the pipe and thus nullifies the purpose of the casing. Pressure grouting of the entire annular space between the casing and carrier pipe is not recommended unless grouting pressure is controlled to pressure below that which would cause buckling failure of the carrier pipe.

*Note: In some cases, it may be desirable to independently hydrostatically test the in-casing section of pipe.*

**3.13 Trenchless Applications:** There are several methods of installing Ductile iron pipe in trenchless applications including horizontal directional drilling and micro-tunneling. Ductile iron pipe, manufactured in accordance with ANSI/AWWA C151/A21.51, can be installed using various trenchless methods including slip-lining and directional drilling. The methods involve forming an appropriately sized hole that is larger than the outside diameter of the pipe joint. When pipe is pulled into position, restrained joints are normally utilized.

**3.14 Provision for Electrical Thawing:** Several methods are available for conducting direct current across joints when necessary to electrically thaw a pipe. These methods include gaskets containing metal contact strips, wedges inserted at the joints, conductive cables and metal strips applied at the foundry, or cables applied in the field.

To prevent future problems, the correct number of wedges to be inserted at the joint or conductive strip or cable sizing should be calculated using an adequate safety factor with regard to electrical current needs for thawing. Likewise, strips and connections to the pipes should be electrically insulated from the backfill when required by the engineer.



## Chapter 4 Valves

**4.1 Inspecting Valves:** Prior to installation, valves should be inspected for direction of opening, number of turns to open, freedom of operation, tightness of test plugs, cleanliness of valve ports and seating surfaces, handling damage, and cracks. Defective valves should be corrected or held for inspection by the owner. All bolts and nuts should be checked for proper tightness with the exception of seat-adjusting bolts or screws in butterfly valves, which should be adjusted only on the manufacturer's recommendation.

**4.2 Installing Valves:** To ensure that the pipe will not be required to sustain the weight of heavy valves (8-inch and larger), they should be provided with support, such as treated timbers, crushed stone, concrete pads, or a thoroughly tamped trench bottom. Valves installed above ground or in plant piping systems should be supported to prevent bending of the valve end connections as a result of pipe loading.

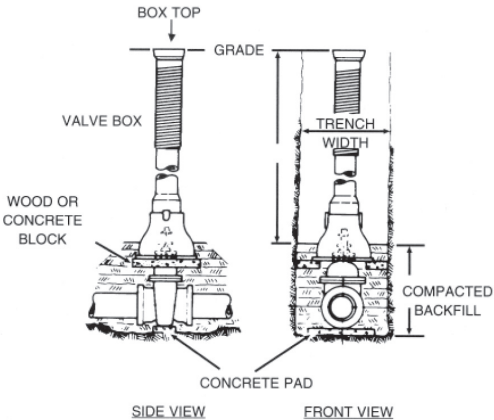

Valves can be placed in concrete or masonry vaults or buried in the soil with a valve box, or other device to allow access and operation, placed over the valve operator. All valves with exposed gearing should be installed in a vault. Access manholes should be large enough to allow removal of the valve if future replacement is necessary.

If the valves are in a concrete or masonry vault, wall penetrations should incorporate a space of at least 2 inches between the concrete and the pipe to ensure that the weight of the vault will not rest on the water main.

When valve boxes are used, they should rest above the valve so that the weight of truck traffic passing over the street will not be transferred to the valve or the pipe. The bottom flared edge of the box may require extra support such as a 2-inch x 6-inch x 18-inch timber on each side of the valve. Concrete pavement slabs should not be poured around the top portion of the valve. When flanged end valves are used underground, one or more flexible pipe joints should be located near the valves.

Thrust resulting from valve closure should be carefully considered in the design of the piping system and vaults. Where thrust restraint is not specifically provided for, pipe joints should normally be installed without deflecting the joints and the joints should be pushed home on both sides of the valve.

**4.3 Valve Operations:** Existing valves and hydrants that serve the new main should be opened and closed by waterworks employees

only. A new valve should be installed near the beginning of a new main to be used by the construction crew and to provide a valve which will close tightly while pressure-leakage tests are being conducted.



**4.4 New Valves in Existing Mains:** Special cutting-in valves and sleeves are commonly used by water utilities and contractors to install



new valves in existing mains. Alternately, a solid sleeve can be used to install a new valve in an existing main. With this method, the valve should be held firmly in place in the line by using a filler piece of pipe to fill the gap inside the sleeve

so that when pressure is on one side of the closed valve, the thrust will not push the valve along the line and cause a leak or possible joint separation.

**4.5 Installing Blowoffs and Vents:** The discharge for blowoffs and drains should be installed so that there is no possibility of sewage or other contamination entering the water main. The blowoffs and drains should discharge above ground and have an air gap of at least two pipe diameters at the sewer or receiving stream. Air release and vacuum vents should be provided

at high points in the line as well as in areas of negative pressure. All dead ends on new mains should be closed with plugs or caps that are suitably restrained to prevent blowing off under pressure. All dead ends should be equipped with suitable blowoff or venting devices.

**4.6 Inspecting Hydrants:** Prior to installation, hydrants should be inspected for direction of opening, nozzle threading, operating nut and cap nut dimensions, tightness of pressure-containing bolting, cleanliness of inlet elbow, handling damage, and cracks. Defective hydrants should be corrected or held for inspection by the owner.

**4.7 Installing Fire Hydrants:** Hydrants should be installed in the parkway or other locations where they will be readily accessible yet remain out of the path of automobiles and pedestrians. When hydrants are placed behind the curb a liberal setback is advisable so that car bumpers will not strike the hydrant before the tires hit the curb. When installed in a lawn or parkway, the hydrant should be placed one to two feet from the edge of the walk for the safety of pedestrians. A gate valve should be installed in the hydrant branch far enough from the hydrant to allow for hydrant maintenance without interrupting the flow of the main line.



Most hydrants have a grade-line marking and should be ordered for the proper depth of pipe cover so that the hose and pumper nozzles will be at the correct height. The connecting line to the supply main should be no less than 6-inches in diameter. Refer to AWWA Manual M-17 for proper fire hydrant installation.

**4.8 Hydrant Drainage:** In areas where temperatures during winter months would cause freezing of the hydrant barrels if they were not drained, drainage pits 2 feet x 2 feet x 2 feet should be excavated below the hydrants. The pits should be filled with coarse gravel or crushed stone mixed with sand to a depth of 6 inches above the hydrant openings, providing sufficient aggregate void space to more than equal the volume of the barrels. The drainage pits should neither be near nor be connected to sewers. When the hydrant leads are to be encased in polyethylene, tape should be applied circumferentially above and below the drainage holes in the hydrant riser and the film removed to allow the hydrant barrel to drain.

**4.9 Hydrant Anchorage:** Numerous methods are used to anchor fire hydrants, including thrust blocks, tie rods, and special restrained fittings or joints. If thrust blocks are used the hydrant should rest on a concrete pad and, the thrust block poured to rest against undisturbed soil.

*Caution: Be sure that the hydrant drain port is not clogged and is free to drain the hydrant, including when the pipe is encased in polyethylene. Also, the thrust block should be designed to restrain thrust created by the system pressure plus water hammer or test pressure, whichever is greater*

If tie rods are installed, they should be connected from the hydrant to the distribution main, not to the hydrant feeder main or the hydrant valve. These rods should be coated with protective paint or tar to retard corrosion. Restrained fire hydrant fittings are discussed in the section entitled “Restrained Joints.”

To prevent water hammer, hydrants should be closed very slowly, especially during the last few turns near full closure.

## Chapter 5 Restraining Thrusts

**5.1 Thrust Forces:** Thrust forces are created in water mains when the pipeline changes directions (at bends and tees), stops (at dead ends and closed valves), or changes in size (at reducers). To keep the pipeline intact, there are several methods of restraint available, including thrust blocks, restrained joints, and tie rods. The thrust to be restrained is given in the table below.

**Table 7**  
**Resultant Thrust at Fittings at 100 psi**  
**Water Pressure**

Total Pounds					
Nominal Pipe Dia. (inches)	Dead End	90° Bend	45° Bend	22.5° Bend	11.25° Bend
3	1,232	1,742	943	481	241
4	1,810	2,559	1,385	706	355
6	3,739	5,288	2,862	1,459	733
8	6,433	9,097	4,923	2,510	1,261
10	9,677	13,685	7,406	3,776	1,897
12	13,685	19,353	10,474	5,340	2,683
14	18,385	26,001	14,072	7,174	3,604
16	23,779	33,628	18,199	9,278	4,661
18	29,865	42,235	22,858	11,653	5,855
20	36,644	51,822	28,046	14,298	7,183
24	52,279	73,934	40,013	20,398	10,249
30	80,425	113,738	61,554	31,380	15,766
36	115,209	162,931	88,177	44,952	22,585
42	155,528	219,950	119,036	60,684	30,489
48	202,683	286,637	155,127	79,083	39,733
54	260,214	367,999	199,160	101,531	51,011
60	298,121	421,606	228,172	116,321	58,422
64	338,707	479,004	259,235	132,157	66,398

*Table 7 Note: To determine thrust at pressures other than 100 psi, multiply the thrust obtained in the table by the ratio of the pressure to 100.*

*For example, the thrust on a 12-inch, 90° bend at 125 psi is  $19,353 \times \frac{125}{100} = 24,191$  pounds.*

**5.2 Thrust Blocks:** Although thrust blocks are typically made of concrete, hardwood or stone is occasionally used. Concrete must be of good quality as it transmits the thrust force from the fitting to undisturbed soil.

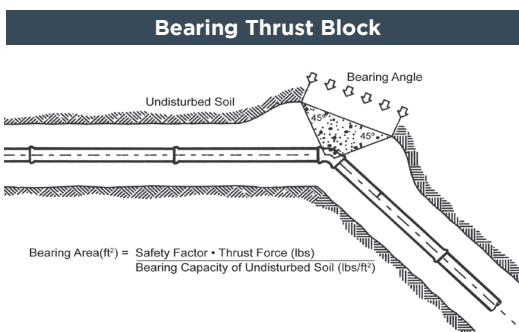

When constructing thrust blocks, care should be taken to assure that the joint, including bolts, will be accessible. Also, a sheet of polyethylene film is sometimes placed between the fitting and the block to aid in later removal if desired. While the engineer usually specifies the concrete mix for thrust blocks, compressive strength at 28 days should be at least 2,000 psi and minimum curing time should be five days. When installing thrust blocks, the dimensions should be strictly adhered to as they have been designed for the specific water pressure and external soil conditions. Thrust blocks at fittings are located where the resultant force of the thrust is directed. The illustrations shown depict typical bearing and gravity thrust blocks.



## Gravity Trust Block

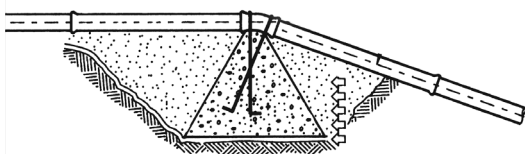

Gravity Block

$$\text{Gravity Block Size (ft}^2\text{)} = \frac{\text{Safety Factor} \cdot \text{Thrust Force (lb)}}{\text{Density of Block Material (lb/ft}^2\text{)}}$$

The following often-used soil bearing capacities for depths of 4 feet are listed only as a guide.\* The engineer should select bearing values for each soil type and depth of cover encountered on the specific pipeline project. Appropriate safety factors should be applied to cover future changes in pipe depth, soil bearing capabilities, and other factors.

**Table 8**  
**Soil Bearing Capacities**

Soil	Bearing Load (lb./sq./ft.)
Muck	0
Soft Clay	1,000
Silt	1,500
Sandy Silt	3,000
Sand	4,000
Sandy Clay	6,000
Hard Clay	9,000

\*DIPRA cannot assume responsibility for the accuracy of the data in this table because of the wide variation of bearing load capabilities for each soil type.

**5.3 Restrained Joints:** Restrained push-on and restrained mechanical joints are used for resisting thrust forces as an alternative to thrust blocking and/or where there is a shortage of space because of other utilities and structures and where there is a possibility that the soil behind a fitting will be disturbed. These special joints are simply and quickly installed. For details regarding the variety of restrained joints available, please visit our member company websites.

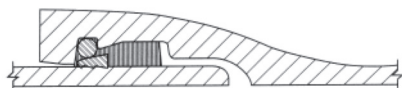

Fast-Grip® Gasket (4"-30")

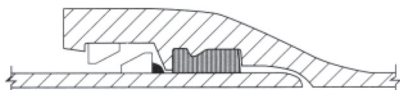

Flex-Ring® (4"-12")

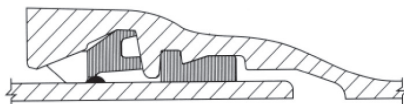

Flex-Ring® (14"-54")

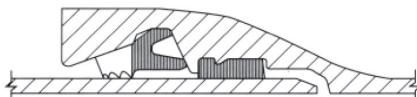

Field Flex-Ring® (14"-36")

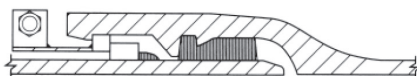

Lok-Ring® (60"-64")



Mechanical with Tyton® Joint (6"-24")

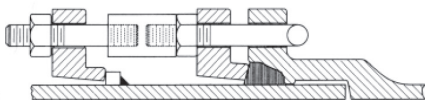

MJ Coupled Joint (6"-24")

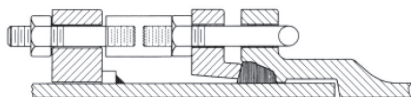

MJ Coupled Joint (30"-48")

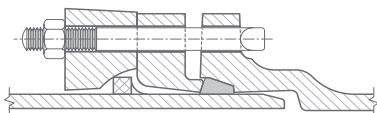

BOLT-LOK™ (4"-24")

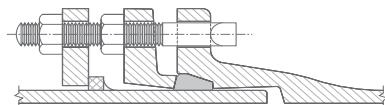

MECH-LOK™ (6"-48")

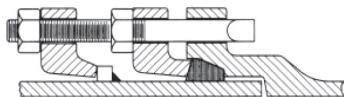

MJ Lock (3"-24")

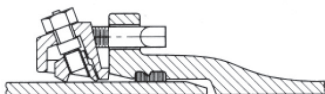

Wedge Action Restrainer for Tyton Joint® (6"-24")

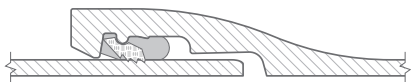

FIELD LOK 350® Gasket (4"-12")



Sure Stop 350® Gasket (3"-24")

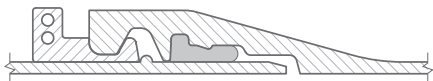

HP LOK® (30"-64")

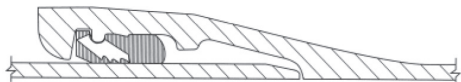

FIELD LOK 350® Gasket (14"-24")

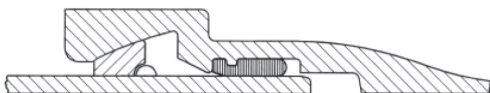

TR FLEX® (4"-24")

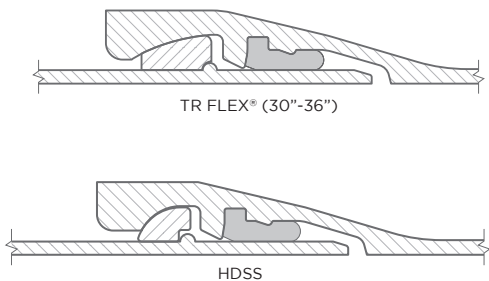

The usual method of thrust restraint is to use these special joints at the fitting and for a predetermined number of lengths of pipe on each side unless, of course, the entire installation is restrained.

For more detailed information on determining the lengths of pipe to be restrained, refer to the latest edition of DIPRA's publication, [Thrust Restraint Design for Ductile Iron Pipe](#). DIPRA has also developed a [computer program](#) with the same name.

**5.4 Tie Rods:** Tie rods are used to restrain thrust forces in many ways, either alone or with other methods. The number and size of rods are limited by economics and practicality. For mechanical joints, tie rods may be threaded through the bolt holes in the flange and secured by nuts attached to the rod using spacers. As in using special restrained joints, more than one length of pipe on each side of the fitting may require restraint.

*Note: Corrosion protection of tie rod systems should be considered, and steel tie rods are often provided with a protective coating in the field.*

**5.5 Seismic Joints:** Seismic joints have been designed to accommodate large ground movements associated with seismic events. These joints allow for greater deflection and expansion/contraction compared to conventional restrained joints. Because it may not be known whether pipe movement will expand or compress a seismic joint, these special joints must be assembled so as to allow for either type of movement. As with conventional restrained joints, for details regarding their assembly, please visit each of DIPRA's member company websites.

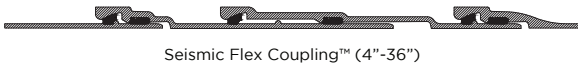
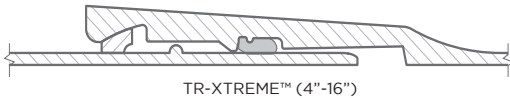

## Chapter 6 Backfilling

**6.1 Backfilling:** Backfilling is one of the most important phases of water main construction, and careful attention to its proper execution cannot be overstressed. The purpose of backfill is not only to fill the trench but also to protect the pipe and provide support along and under it. (See Section 3.1 Standard Laying Conditions.)

Backfill material should be of good quality and free from cinders, frozen material, ashes, refuse, boulders, rocks, or organic material. Soil containing cobbles up to 8 inches in their greatest dimension may be used from one foot above the top of the pipe to the ground surface or pavement subgrade.

### **6.2 Backfilling Under Streets:**

Local authorities normally require that backfill under streets be compacted up to the street subgrade. The soil is normally compacted in 6- to 12-inch lifts using mechanical compactors. Many cities require that the entire trench be filled with compacted select backfill, such as sand, gravel, or limestone screenings. While compaction below and to the top of the pipe benefits the water main, all tamping above this height is to support the new pavement. When flowable fill is used, it is recommended that the pipe be encased in polyethylene. It is also cautioned that the flowable fill material not be placed directly in contact with the encased pipe, but that approximately 12 inches of select backfill be placed above the pipe prior to installing the flowable fill.

Pavement is usually cut 6 inches wider than the trench on each side to permit a firm foundation when it is replaced. It is advisable to contact local authorities since requirements vary from city to city.

### **6.3 Backfilling in Non-paved Areas:**

Parkways and other non-paved areas may need no compaction, depending on the trench condition required. Water jetting or trench flooding may be used to obtain the necessary compaction.

### **6.4 Backfilling in Restrained Joint Areas:**

Backfill in restrained joint areas should be well-compacted to allow the development of passive soil pressure resistance and thereby restrict possible pipe movement.

**6.5 Frozen Backfill:** Frozen backfill should not be placed in the trench. The frozen portion of the soil should be removed and only thawed material placed in the trench. If all of the soil is frozen, it is then necessary to backfill with graded granular material.

### **6.6 Cleanup and Pavement Replacement:**

When work is complete, all pieces of pipe, extra fittings, tools, and incidental materials, including rubbish and excess spoil material, should be removed from the street or right-of-way. All undamaged walks and pavements should be cleaned, and the reseeding and replacement of sod, shrubs, trees, and other plants should be completed.

Damaged and removed pavement should be replaced according to local specifications and standards.



## Chapter 7

### Flushing, Testing, and Disinfecting

**7.1 Flushing:** Foreign material left in the pipeline during installation often results in valve or hydrant seat leakage during pressure tests. Every effort should be made to keep lines clean during installation. Thorough flushing is recommended prior to pressure testing. Flushing should be accomplished by partially opening and closing valves and hydrants several times under expected line pressure with adequate flow velocities to flush foreign material out of the valves and hydrants. Table 9 lists the required flow and openings to flush pipelines to obtain a velocity of 3.0 fps.

The use of pressure washing to clean the inside diameter of cement-mortar lined iron pipe should be done with caution, using recommendations from DIPRA or the pipe manufacturer. Over-blasting may result in damage to the seal coat and/or cement-mortar lining. The aggressiveness of the pressure washing is dependent on water pressure, travel speed, water jets, water jet angle to the lining, distance of the water jets from the lining, diameter of pipe, type of lining application, etc. Pressure washing is done at the sole risk of the equipment operator.

**Table 9**

**Required Flow and Openings (Either Taps or Hydrants) to Flush Pipelines at 3.0 ft/sec (0.91 m/sec) (40-psi [276 kPa] Residual Pressure in Water Main)\*††**

Pipe Diameter		Flow Required to Produce 3.0 ft/s (approx.) Velocity in Main		Size of Tap in. (mm)			Number of Hydrant Outlets in. (mm)	
in.	mm	gpm	L/sec	1 (25)	1-1/2 (38)	2 (51)	2-1/2 (64)	4-1/2 (114)
				Number of Taps on Pipe†				
4	100	120	7.4	1	-	-	1	1
6	150	260	16.7	-	1	-	1	1
8	200	470	29.7	-	2	-	1	1
10	250	730	46.3	-	3	2	1	1
12	300	1,060	66.7	-	-	3	2	1
16	400	1,880	118.6	-	-	5	2	1

\*With a 40-psi (276 kPa) pressure in the main with the hydrant flowing to atmosphere, a 2-1/2-inch (64-mm) hydrant outlet will discharge approximately 1,000 gpm (63.1 L/sec); and a 4-1/2-inch (114-mm) hydrant outlet will discharge approximately 2,500 gpm (160 L/sec).

†Number of taps on pipe based on 3.0-ft/sec discharge through 5 ft. (1.5 m) of galvanized iron (GI) pipe with one 90° elbow.

††Table taken from ANSI/AWWA C651-14.

**Table 10**  
**Hydrostatic Testing Allowance Per 1000 Ft. of Pipeline\* - gph**

Average Test Pressure (psi)	Nominal Pipe Diameter (inches)														Average Test Pressure (psi)				
	3	4	6	8	10	12	14	16	18	20	24	30	36	42		48	54	60	64
450	.43	.57	.86	1.15	1.43	1.72	2.01	2.29	2.58	2.87	3.44	4.30	5.16	6.02	6.88	7.74	8.60	9.17	450
400	.41	.54	.81	1.08	1.35	1.62	1.89	2.16	2.43	2.70	3.24	4.05	4.86	5.68	6.49	7.30	8.11	8.65	400
350	.38	.51	.76	1.01	1.26	1.52	1.77	2.02	2.28	2.53	3.03	3.79	4.55	5.31	6.07	6.83	7.58	8.09	350
300	.35	.47	.70	.94	1.17	1.40	1.64	1.87	2.11	2.34	2.81	3.51	4.21	4.92	5.62	6.32	7.02	7.49	300
275	.34	.45	.67	.90	1.12	1.34	1.57	1.79	2.02	2.24	2.69	3.36	4.03	4.71	5.38	6.05	6.72	7.17	275
250	.32	.43	.64	.85	1.07	1.28	1.50	1.71	1.92	2.14	2.56	3.21	3.85	4.49	5.13	5.77	6.41	6.84	250
225	.30	.41	.61	.81	1.01	1.22	1.42	1.62	1.82	2.03	2.43	3.04	3.65	4.26	4.86	5.47	6.08	6.49	225
200	.29	.38	.57	.76	.96	1.15	1.34	1.53	1.72	1.91	2.29	2.87	3.44	4.01	4.59	5.16	5.73	6.12	200
175	.27	.36	.54	.72	.89	1.07	1.25	1.43	1.61	1.79	2.15	2.68	3.22	3.75	4.29	4.83	5.36	5.72	175
150	.25	.33	.50	.66	.83	.99	1.16	1.32	1.49	1.66	1.99	2.48	2.98	3.48	3.97	4.47	4.97	5.30	150
125	.23	.30	.45	.60	.76	.91	1.06	1.21	1.36	1.51	1.81	2.27	2.72	3.17	3.63	4.08	4.53	4.83	125
100	.20	.27	.41	.54	.68	.81	.95	1.08	1.22	1.35	1.62	2.03	2.43	2.84	3.24	3.65	4.05	4.32	100

*\*If the pipeline under test contains sections of various diameters, the testing allowance will be the sum of the computed allowance for each size.*

**7.2 Hydrostatic Pressure Testing:** Newly installed pipelines are normally pressure tested to confirm proper installation of joints and fittings. When the new pipeline is initially filled, a calculation of a volume of make-up water is determined according to the size and length of the pipeline being tested. The make-up water allowance is not a measure of allowable leakage. It accounts for the absorption of water by the lining and the extension (lengthening) of pipe joints due to the thrust forces that occur when the pipeline is first pressurized.

The pressure test is normally performed after backfilling. When unusual conditions require that pressure testing be accomplished before backfilling or with pipe joints accessible for examination, sufficient backfill material should be placed over the pipe barrel between the joints to prevent movement and consideration should be given to restraining thrust forces during the testing. In particular, restrained joint systems, which derive stability from the interaction of the pipe and soil, should be backfilled prior to testing. The consulting engineer or utility should state the test pressure in the specifications. At least 1.5 times the stated working pressure at the lowest elevation of the test section for a duration of two hours is recommended. The pipeline should be filled slowly, and care should be taken to vent all high points and expel all air. Vents should remain open until water flows from them at a steady flow.

In addition, fittings and hydrants should be properly anchored and all valves should be completely closed before applying the test pressure. When using a valve for a closure piece

of test section, the rated pressure of the valve should not be exceeded.

After the air in the pipe has been expelled and the valve or valves segregating the part of the system under test have been closed, pressure is then applied with a hand pump or gasoline-powered pump or, for large lines, fire department pumping equipment. After the main has been brought up to test pressure, it should be held for at least two hours and the make-up water measured with a displacement meter or by pumping the water from a vessel of known volume.

Any exposed pipe, fittings, valves, hydrants, or joints should be examined carefully during the test. Damaged or defective pipe, fittings, valves, or hydrants that are discovered during the pressure test should be repaired or replaced with sound material and the test repeated until it is satisfactory to the owner. Table 10 lists hydrostatic testing allowance.

If blocking or concrete piers have been used behind fittings, the concrete should be cured sufficiently before hydrostatic tests are conducted.

If tests are conducted daily at the end of the work shift, a temporary plug should be inserted in the bell and the pipeline restrained against thrust created by the test pressure. Do not depend on the weight of a few lengths of pipe to prevent the joints from separating.

**7.3 Disinfecting:** All new water systems, or extensions to existing systems, should be disinfected in accordance with ANSI/AWWA

C651 Standard before being placed in service.

Disinfection of mains should be accomplished only by crews who have had experience with chlorine or other disinfecting agents. Crews responsible for the repair of mains should be aware of the potential health hazards and should be trained to carefully observe prescribed construction practices and disinfection procedures.

The three most commonly used methods of disinfection are the tablet method, the continuous-feed method, and the slug method. The forms of chlorine that may be used in the disinfection operations are liquid chlorine (gas at atmospheric pressure), sodium hypochlorite solution, and calcium hypochlorite granules or tablets.

The tablet method is convenient to use in smaller diameter mains but can only be used if the main can be kept clean and dry during construction. This method gives an average chlorine dose of approximately 25 mg/L. The procedure involves placing calcium hypochlorite granules and tablets in the water main as it is being installed and filling it with potable water upon completion of the installation.

The granules should be placed at the upstream end of the first pipe, at the upstream end of each branch main, and at 500-foot intervals. The quantity of granules should be as shown in Table 11.

The tablets (5-gram calcium hypochlorite) should be attached at the top of the joint at the

beginning of each section of pipe by a food-grade adhesive. The number of tablets required for various pipe sizes is shown in Table 12. Additionally, one tablet should be placed in each hydrant, hydrant branch, and other appurtenance.

**Table 11**

**Weight of Calcium Hypochlorite Granules to be Placed at Beginning of Main and at Each 500-foot (150-m) Interval\***

Pipe Diameter ( <i>d</i> )		Calcium Hypochlorite Granules	
inches	mm	ounces	grams
4	100	1.7	48
6	150	3.8	108
8	200	6.7	190
10	250	10.5	298
12	300	15.1	428
14 and larger	350 and larger	$D^2 \times 15.1$	$D^2 \times 428$

Where *D* is the inside pipe diameter, in feet  $D = d/12$

\*Table taken from ANSI/AWWA C651-14.

**Table 12****Number of 5-gram Calcium Hypochlorite Tablets Required for Dose of 25 mg/L\* †**

Pipe Diameter (inches)	Length of Pipe Section (feet)				
	13 or less	18	20	30	40
4	1	1	1	1	1
6	1	1	1	2	2
8	1	2	2	3	4
10	2	3	3	4	5
12	3	4	4	6	7
16	4	6	7	10	13

\* Based on 3.25 grams available chlorine per tablet; any portion rounded to next higher integer.

† Table taken from ANSI/AWWA C651-14.

When installation of the granules and tablets has been completed, the main is then filled with water at a rate such that water within the main will flow at a velocity no greater than 1 fps. The water is then left in the pipe for a minimum of 24 hours before flushing (48 hours if the water temperature is less than 41°F).

The continuous-feed method is suitable for general application. This method consists of filling the main to remove all air pockets and then flushing to remove particulates. For large diameter mains (24-inch or larger), an acceptable alternative to flushing is to broom-sweep the main, carefully removing all sweepings prior to chlorination. It may also be recommended that calcium hypochlorite granules be placed as described above as part of the continuous-feed method. This would provide a strong concentration of chlorine in



the first flow of flushing water. Water is then introduced at a constant rate into the main such that the water will have no less than 25 mg/L free chlorine. Table 13 gives the amount of chlorine required for each 100 feet of pipe for various diameters. Chlorine application should not cease until the entire main is filled with chlorinated water. The chlorine should then be retained for at least 24 hours at which time the chlorine residual should not be less than 10 mg/L.

**Table 13**

**Chlorine Required to Produce 25 mg/L Concentration in 100 Feet of Pipe - by diameter<sup>†</sup>**

Pipe Diameter (inches)	100 Percent Chlorine (lbs)	1 Percent Chlorine Solution (gallons)
4	0.013	0.16
6	0.030	0.36
8	0.054	0.65
10	0.085	1.02
12	0.120	1.44
16	0.217	2.60

<sup>†</sup>Table taken from ANSI/AWWA C651-14.

The slug method is suitable for use in large-diameter mains where the volume of water involved makes the continuous-feed method impractical. The slug method consists of placing calcium hypochlorite granules as described above, filling the main to remove all air pockets, and flushing to remove particulates.

For large-diameter mains (24-inch or larger), an acceptable alternative to flushing is to broom-sweep the main, carefully removing all sweepings prior to chlorination. A slow flowing slug of water, chlorinated to at least 100 mg/L free chlorine, is then introduced into the main. The slow flow rate shall ensure that all parts of the main will be exposed to the highly chlorinated water for at least 3 hours. If at any time the free chlorine residual drops below 50 mg/L, the flow should be stopped, and the procedure should be restarted at that location with the free chlorine restored to not less than 100 mg/L.

**Following chlorination, the main should be flushed as soon as possible (within 24 hours) since prolonged exposure to high concentrations of chlorine may damage the seal coat.**

Precautions should be taken to ensure that the chlorinated discharge will not cause damage to the environment. If the chlorinated discharge will cause damage to the environment, a neutralizing chemical shall be applied. ANSI/AWWA C655 provides information on neutralizing chemicals. Where necessary, federal, state, provincial, and local regulatory agencies should be contacted to determine special provisions for the disposal of heavily chlorinated water.

After the final flushing, bacteriological tests should be performed in accordance with state and local regulations to ensure that there are no coliform organisms. For more detailed information, refer to ANSI/AWWA C651 Standard for Disinfecting Water Mains.

**7.4 Repairing Pipe:** Many devices and materials are used to repair pipe. Holes are most commonly repaired using mechanical joint split sleeves or bolted repair clamps that encircle the pipe. Special sleeves similar to the mechanical joint split sleeve, interior joint sealing devices, and special bell clamps are available for repairing leaking joints. An inventory of repair materials should be maintained for each size of pipe in the system to ensure rapid repair and minimal inconvenience to customers.

Proper sanitary and disinfecting procedures are extremely important when repairing main breaks in potable water pipelines. Procedures for disinfection are found in ANSI/AWWA C651 Standard.

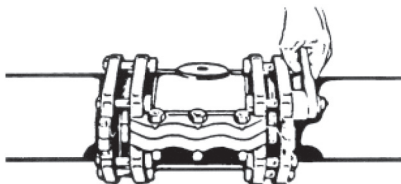

*Note: When disinfecting water mains after repairs have been made, caution must be exercised to ensure that a strong concentration of chlorine does not enter customer service lines.*

## Chapter 8

### Service Taps

**8.1 Taps:** Service taps are easily made either before or after Ductile iron pipe installation. The minimum pressure class of all diameters of Ductile iron pipe may be direct tapped for 3/4-inch services. Additionally, the minimum pressure class of 6-inch and larger Ductile iron pipe may be direct tapped for 1-inch services. Usually, the services are located at ten or two o'clock on the circumference of the pipe and can be screwed directly into the tapped and threaded pipe.

Standard corporation stops can be used on all pressure classes of Ductile iron pipe. Compression joint corporation stops can also be used effectively. If the taps are for vents or pitometer connections, they should be placed on top of the pipe. Allowance for any possible movement of the main or service piping should be made by making a half loop in the service piping at the tap and firmly compacting the backfill under this loop. When more than one tap in an existing gray iron pipe is necessary to deliver the required flow for service lines, the taps should be staggered around the circumference at least 12 inches apart and not drilled in a straight line. These restrictions do not apply to Ductile iron pipe.



The preferred and recommended method of making direct service taps on polyethylene-encased pipe consists of applying two or three wraps of polyethylene adhesive tape completely around the pipe to cover the area where the tapping machine and chain will be mounted. This method minimizes possible damage to the polyethylene during the direct-tapping procedure. After the tapping machine is mounted, the corporation stop is installed directly through the tape and polyethylene as shown.

Experience has shown that this method is very effective in eliminating damage to the polyethylene encasement by the tapping machine and chain during the tapping operation.

Service taps can also be made on existing polyethylene-encased gray and Ductile Iron mains by making an X-shaped cut in the polyethylene and temporarily folding back the film or by tapping directly through the polyethylene.

After the tap is completed, cuts, tears, or other areas of damage to the polyethylene encasement should be repaired with tape and extra film as described in ANSI/AWWA C105/A21.5.

If a tapping saddle is to be used, a method similar to the above procedure for direct taps should be used. The polyethylene should be provided with several wraps of polyethylene adhesive tape completely around the circumference of the pipe. Then, the tape and film should be removed from the area where

the saddle gasket will be in contact with the surface of the pipe. After the saddle is installed, the assembly may be encased with new polyethylene film that overlaps on both sides of the existing wrap and is taped securely in place.

Direct connection of copper services to gray and Ductile iron pipelines has long been a common practice in the waterworks industry. To minimize the possibility of corrosion, service lines of dissimilar metals and the attendant corporation stop should be wrapped with polyethylene or a suitable dielectric tape for a minimum clear distance of 3 feet away from the main.

In addition, grounding of household electrical services to the copper water service line may, on rare occasion, result in stray direct current corrosion of the copper service or the gray or ductile iron main. AWWA policy opposes the grounding of electrical systems to pipe systems conveying drinking water to a customer's premises. AWWA further states that interior piping systems may be connected to an electrical service neutral and to a separate grounding electrode provided these systems are electrically insulated from the water utility's pipe system. DIPRA endorses this AWWA policy and recommends that water utilities require that service lines of dissimilar metals be electrically insulated from their pipe system.

**8.2 Maximum Size Taps:** The maximum size and number of corporation stops permissible for various main sizes are usually set by local codes, generally the plumbing code. Necessary pipe thicknesses for different tap sizes are

outlined in tables in Chapter 10, “Useful Information.” Because of the high strength of ductile iron, the number of threads engaged is less critical than with lower strength material. Extensive testing has shown that with two threads engaged, the limiting factor on the physical strength of the tap is the strength of the body of the corporation stop. Tested ductile iron threads did not fail under either tension or shear forces.

Additionally, based on direct tapping tests, the maximum recommended direct tap sizes, to ensure a water-tight tap, for 3- through 24-inch are shown in Table 14. All classes of 24 inches and larger in diameter can be direct tapped for 2-inch corporation stops. The cut-off at 2-inch diameter taps was chosen because most, if not all, tapping machines used to direct tap pressurized mains are limited to a maximum tap size of 2 inches.



Two layers of 3-mil TFE applied to the male threads of the corporation stop also effectively reduce installation torque requirements.

**Table 14****Maximum Recommended Direct Tap Size for 3- Through 24-inch Ductile Iron Pipe**

Pipe Diameter (inches)	Pressure Class				
	150	200	250	300	350
Maximum Recommended Direct Tap Size					
3	-	-	-	-	3/4
4	-	-	-	-	3/4
6	-	-	-	-	1
8	-	-	-	-	1
10	-	-	-	-	1
12	-	-	-	-	1-1/4
14	-	-	1-1/4	1-1/2	1-1/2
16	-	-	1-1/2	2	2
18	-	-	2	2	2
20	-	-	2	2	2
24	-	2	2	2	2

**8.3 Large Connections:** Large services are provided for schools, factories, and other facilities by using a tee or by placing a split tapping sleeve or tapping saddle on the pipe to which a tapping valve is bolted. [See MSS SP-60: Connecting Flange Joint between Tapping Sleeves and Tapping Valves, and MSS SP-111: Gray Iron and Ductile Iron Tapping Sleeves.] A special tapping machine is required for cutting a disc from the wall of the pipe while under pressure. Split sleeves and tapping saddles are available with mechanical joint accessories. Instructions for making a tap with these fittings are supplied by both fitting and tapping machine manufacturers. These appurtenances



are available for most pipe sizes. Tapping machines may be purchased or rented with or without an operator. Be sure the cutting tool diameter is less than the valve open diameter prior to assembling the equipment.

## Chapter 9 Special Installations

**9.1 Pipe Through Walls:** Wall pipes or wall sleeves should be used where Ductile iron water mains pass through concrete walls of meter vaults, large valve pits, or other walls to eliminate a rigid connection between the pipe and wall. The sleeve or wall pipe provides flexibility to prevent the pipe from being subjected to heavy beam loading.

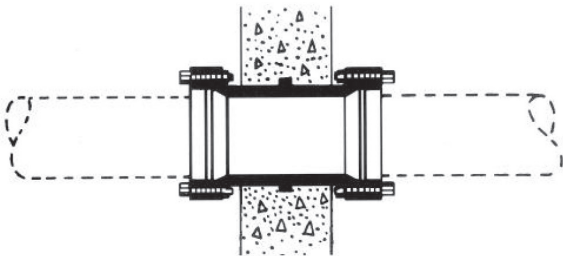

Additionally, it is good practice to locate a flexible joint about 18 inches from the outside face of the wall. The trench bottom under the pipe leading into a building or vault should be firmly tamped to minimize settlement under the pipe. If soil conditions indicate that significant settlement will occur, at least 2 inches of crushed stone should be compacted to provide a permanent support under the pipe. Remember, all pipes entering walls from the outside must be protected from cantilever beam action.

**9.2 Subaqueous Pipe:** When it is necessary to cross a body of water requiring only a small deflection in the joints, and joint restraint is not a consideration, standard push-on or

mechanical joint pipe can be used. If the water is deep and the angle of deflection in the joint necessary to follow the contour of the riverbed is great, ball and socket pipe—with a deflection up to 15°—should be used. A combination of restrained and ball and socket joints may be used depending on bottom conditions and service requirements. For details on the various ball and socket pipe joints that are available, please visit our member company websites.

### Ball and Socket Joints



Flex-Lok® (4"-24")



Flex-Lok® (30"-54")

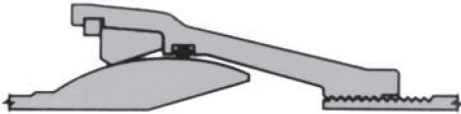

SNAP-Lok™ (6"-24")

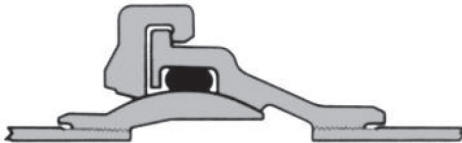

Ball and Socket (6"-36")



M-FLEX



USIFLEX® (42"-48")

There are several methods of installing ball and socket Ductile iron pipe. It can be assembled in sections of three or four lengths, either on shore or on the deck of a barge, attached to a “strongback,” and lowered to the stream bed where divers connect the sections. (Ball and socket pipes use joints with positive locking devices.) Ball and socket pipe can also be assembled on a chute affixed to the side of a barge and lowered into position as assembly progresses.



Another installation method involves assembling the pipeline on shore and dragging it into position along the bottom. The pipe can also be floated into position by attaching barrels or floats to the pipe, which are punctured or released in a controlled fashion when the pipe reaches the desired position.

A similar method involves assembling the pipe on shore, pulling it down skids into the water as each length is connected, then attaching floats. The line extends farther into the water as each successive length is laid, and the finished line is submerged in the manner described above.

Subaqueous lines laid in navigable streams must be placed in trenches and covered to protect them from injury or displacement by ship or boat traffic. Where applicable, procedures should conform to appropriate governmental regulations. In all cases, joints should not be allowed to become overly deflected or subjected to excessive beam load.

### **9.3 Pipe on Supports or Bridge Crossings:**

The usual practice of installing pipe on supports is to have one support per length of pipe located behind the pipe bell. For underground installations, closer spacing of supports may be necessary due to greater external loads imposed on the pipe. For above ground installations, it is necessary to assure a minimum of lateral and vertical stability at the supports. Deflected pipe joints can result in thrust forces of hydrostatic or hydrodynamic origin, and if not laterally and vertically restrained unbalanced forces may result in additional joint deflection and possible failure of the pipeline.

Thermal expansion of Ductile iron pipelines supported above ground is not usually of concern in correctly designed and installed systems because of the nature of the push-on or mechanical joint. A 100-degree Fahrenheit change in temperature results in expansion or contraction of a 20-foot length of Ductile iron pipe of approximately 0.15 inches. This is easily accommodated by correctly installed pipe and joints. Occasionally, where structures from which Ductile iron pipe is to be suspended are expected to have significantly different behavior than the pipeline, special considerations for expansion, contraction, and supports may be necessary.



*Note: DIPRA member companies have special joints that allow spans of more than one pipe length in some cases*

**9.4 Pipe Insulation:** Insulation is necessary in climates where water mains on supports or in casings are subject to freezing. Insulation is also used on some services to reduce heat losses. It may be necessary to provide for expansion-contraction and thrust restraint in some cases. Special gaskets or other provisions may also be required for high-temperature service.

Insulation materials may be made of fiberglass, cellular glass, expanded polystyrene, urethane, and other materials. Waterproof barriers covering the insulation are usually made of asphalt mastic cement, asphalt-coated glass fiber, and corrugated aluminum. The thickness of the insulating material should be carefully calculated and installed in accordance with instructions of the engineer, manufacturer, or utility. Metallic sleeves should be placed at supports around the insulation to prevent it from being crushed.

*Note: Insulation does not contribute heat input but merely decreases the rate of heat loss. Thus, provisions for heat input to prevent freezing may be necessary.*



## Notes



## Chapter 10 Useful Information

### Standards

ANSI/AWWA C104/ A21.4	Cement-Mortar Lining For Ductile Iron Pipe and Fittings
ANSI/AWWA C105/A21.5	Polyethylene Encasement for Ductile Iron Pipe Systems
ANSI/AWWA C110/ A21.10	Ductile Iron and Gray Iron Fittings
ANSI/AWWA C111/A21.11	Rubber-Gasket Joints for Ductile Iron Pressure Pipe and Fittings
ANSI/AWWA C115/A21.15	Flanged Ductile Iron Pipe with Ductile Iron or Gray Iron Threaded Flanges
ANSI/AWWA C116/ A21.16	Protective Fusion- Bonded Coatings for the Interior and Exterior Surfaces of Ductile Iron and Gray-Iron Fittings

## Standards continued

ANSI/AWWA C150/ A21.50	Thickness Design of Ductile Iron Pipe
ANSI/AWWA C151/A21.51	Ductile Iron Pipe, Centrifugally Cast
ANSI/AWWA C153/ A21.53	Ductile Iron Compact Fittings
ANSI/AWWA C600	Installation of Ductile Iron Water Mains and Their Appurtenances
ANSI/AWWA C606	Grooved and Shouldered Joints
ANSI/AWWA C651	Disinfecting Water Mains
ASTM A674	Polyethylene Encasement for Ductile Iron Pipe for Water or Other Liquids
ASTM G218	Guide for External Corrosion Protection of Ductile Iron Pipe Utilizing Polyethylene Encasement Supplemented by Cathodic Protection

ASTM A716	Ductile Iron Culvert Pipe
ASTM A746	Ductile Iron Gravity Sewer Pipe
MSS SP-60	Connecting Flange Joint between Tapping Sleeves and Tapping Valves
MSS SP-111	Gray Iron and Ductile Iron Tapping Sleeves

## Standards Organizations

American National Standards Institute (ANSI)  
11 West 42nd Street  
New York, New York 10036

American Society for Testing and Materials (ASTM) 100 Barr Harbor Drive  
West Conshohocken, Pennsylvania 19428

American Society of Mechanical Engineers (ASME)  
345 East 47th Street  
New York, New York 10017

American Water Works Association (AWWA)  
6666 West Quincy Avenue  
Denver, Colorado 80235

Manufacturers Standardization Society (MSS)  
Valve and Fittings Industry, Inc.  
127 Park Street, N.E. Vienna, Virginia 22180

## Installation of Ductile Iron Pipe for Special Applications

For special recommendations concerning the installation of compressed air pipelines, chemical process piping, and other special applications, contact DIPRA member companies.

### Linear Expansion of Ductile Iron Pipe

The coefficient of linear expansion of Ductile iron may be taken as  $6.2 \times 10^{-6}$  inches per inch-°F. The expansion or contraction in inches that will take place in a line of given length with various temperature changes is shown in the following table:

**Table 15**

### Linear Expansion of Ductile Iron Pipe— inches

Temperature Difference (°F)	Length of Line (feet)			
	100	500	1000	5280
5	0.037	0.19	0.37	1.96
10	0.074	0.37	0.74	3.93
20	0.149	0.74	1.48	7.86
30	0.223	1.12	2.23	11.78
40	0.298	1.49	2.98	15.71
50	0.372	1.86	3.72	19.64
60	0.446	2.23	4.46	23.57
70	0.520	2.60	5.20	27.50
80	0.595	2.98	5.95	31.43
90	0.670	3.35	6.70	35.35
100	0.744	3.72	7.44	39.28
120	0.893	4.46	8.93	47.14
150	1.116	5.58	11.16	58.92

**Table 16****Conversion Factors**

<b>Multiply</b>	<b>By</b>	<b>To Obtain</b>
Acres	43,560	Square feet
Acres	4,047	Square meters
Acre-Feet	43,560	Cubic feet
Acre-Feet	325,851	Gallons
Atmospheres	29.92	Inches of mercury
Atmospheres	33.90	Feet of water
Atmospheres	14.70	Pounds/square inch
Bars	14.5	Pounds/square inch
Centimeters	0.3937	Inches
Centimeters	0.01	Meters
Centimeters	10	Millimeters
Cubic feet	1728	Cubic inches
Cubic feet	0.02832	Cubic meters
Cubic feet	0.03704	Cubic yards
Cubic feet	7.48052	Gallons
Cubic feet/minute	0.1247	Gallons/second
Cubic feet/minute	62.4	Pounds of water/minute
Cubic feet/second	0.646317	Million gallons/day
Cubic feet/second	448.831	Gallons/minute
Cubic inches	$5.787 \times 10^{-4}$	Cubic feet
Cubic inches	$2.143 \times 10^{-5}$	Cubic yards
Cubic inches	$4.329 \times 10^{-3}$	Gallons
Cubic yards	27	Cubic feet
Cubic yards	46,656	Cubic inches
Cubic yards	201.974	Gallons

<b>Multiply</b>	<b>By</b>	<b>To Obtain</b>
Feet	0.3048	Meters
Feet of water	0.02950	Atmospheres
Feet of water	0.8826	Inches of mercury
Feet of water	0.4335	Pounds/square inch
Feet/minute	0.01667	Feet/second
Feet/minute	0.01136	Miles/hour
Feet/second	0.6818	Miles/hour
Gallons	0.1337	Cubic feet
Gallons	231	Cubic inches
Gallons water	8.3453	Pounds of water
Gallons/minute	$1.440 \times 10^{-3}$	Million gallons/day
Gallons/minute	$2.228 \times 10^{-3}$	Cubic feet/second
Gallons/minute	8.0208	Cubic feet/hour
Gallons water/minute	6.0086	Tons water/24 hours
Grains/U.S. gallon	17.118	Parts/million
Horsepower	42.44	B.T.U./minute
Horsepower	33,000	Foot-pounds/minute
Horsepower	550	Foot-pounds/second
Horsepower	0.7457	Kilowatts
Horsepower (boiler)	33,479	B.T.U./hour
Inches	2.540	Centimeters
Inches of mercury	0.03342	Atmospheres
Inches of mercury	1.133	Feet of water
Inches of mercury	0.4912	Pounds/square inch

<b>Multiply</b>	<b>By</b>	<b>To Obtain</b>
Inches of water	0.002458	Atmospheres
Inches of water	0.03613	Pounds/square inch
Kilometers	0.621	Miles
Miles	5,280	Feet
Miles	1.6093	Kilometers
Miles/hour	88	Feet/minute
Miles/hour	1.467	Feet/second
Milligrams/liter	1	Parts/million
Million gallons/day	1.54723	Cubic feet/second
Million gallons/day	694.444	Gallons/minute
Parts/million	0.0584	Grains/U.S. gallon
Parts/million	8.345	Lbs./million gallon
Pounds	16	Ounces
Pounds	0.0005	Tons (short)
Pounds of water	0.01602	Cubic feet
Pounds of water	27.68	Cubic inches
Pounds of water	0.1198	Gallons
Pounds of water/min.	$2.670 \times 10^{-4}$	Cubic feet/second
Pounds/cubic foot	$5.787 \times 10^{-4}$	Pounds/cubic inch
Pounds/square foot	0.01602	Feet of water
Pounds/square foot	$6.944 \times 10^3$	Pounds/square inch
Pounds/square inch	0.06804	Atmospheres
Pounds/square inch	0.06897	Bars
Pounds/square inch	2.307	Feet of water
Pounds/square inch	2.036	Inches of mercury
Pounds/square inch	6.895	Kilopascals

<b>Multiply</b>	<b>By</b>	<b>To Obtain</b>
Quarts	57.75	Cubic inches
Square feet	$2.296 \times 10^5$	Acres
Square feet	144	Square inches
Square feet	$3.587 \times 10^{-3}$	Square miles
Square inches	$6.944 \times 10^3$	Square feet
Square miles	640	Acres
Square miles	$27.88 \times 10^6$	Square feet
Square miles	$3.098 \times 10^6$	Square yards
Square yards	$2.066 \times 10$	Acres
Square yards	9	Square feet
Square yards	$3.228 \times 10^7$	Square miles
Temp. (°C) + 273.15	1	Absolute temp. (°K)
Temp. (°C) + 17.78	1.8	Temperature (°F)
Temp. (°F) - 32	5/9	Temperature (°C)
Tons (short)	2,000	Pounds
Tons of water/24 hours	83.333	Pounds water/hour
Tons of water/24 hours	0.16643	Gallons/minute
Tons of water/24 hours	1.3349	Cubic feet/hour
Watts	$1.341 \times 10^3$	Horsepower
Yards	91.44	Centimeters
Yards	3	Feet
Yards	36	Inches
Yards	0.9144	Meters



## Notes

## Notes

**Table 17****Standard Dimensions and Weights of Push-on Joint Ductile Iron Pipe**

Pipe Size (inches)	Pressure Class	Thickness (inches)	OD <sup>1</sup> (inches)	Weight of Barrel Per Foot (lb.)
3	350	.25	3.96	8.9
4	350	.25	4.80	10.9
6	350	.25	6.90	16.0
8	350	.25	9.05	21.1
10	350	.26	11.10	27.1
12	350	.28	13.20	34.8
14	250	.28	15.30	40.4
	300	.30	15.30	43.3
	350	.31	15.30	44.7
16	250	.30	17.40	49.3
	300	.32	17.40	52.5
	350	.34	17.40	55.8
18	250	.31	19.50	57.2
	300	.34	19.50	62.6
	350	.36	19.50	66.2
20	250	.33	21.60	67.5
	300	.36	21.60	73.5
	350	.38	21.60	77.5
24	200	.33	25.80	80.8
	250	.37	25.80	90.5
	300	.40	25.80	97.7
	350	.43	25.80	104.9
30	150	.34	32.00	103.5
	200	.38	32.00	115.5
	250	.42	32.00	127.5
	300	.45	32.00	136.5
	350	.49	32.00	148.4

<sup>1</sup>Tolerance of OD of spigot end: 3-12 inches, + 0.06 inches; 14-24 inches, + 0.05 inches, - 0.08 inches; 30-48 inches, + 0.08 inches, - 0.06 inches; 54-64 inches, + 0.04 inches, - 0.10 inches.

<sup>2</sup>The bell weights shown above are adequate for 350 psi operating pressure. Bell weights vary due to differences in push-on joint design. The manufacturer shall calculate pipe

Weight of Bell <sup>2</sup> (lb.)	18-ft Laying Length		20-ft Laying Length	
	Weight Per Length <sup>3</sup> (lb.)	Average Weight Per Foot <sup>4</sup> (lb.)	Weight Per Length <sup>3</sup> (lb.)	Average Weight Per Foot <sup>4</sup> (lb.)
7.0	165	9.3	185	9.2
9.0	205	11.4	225	11.3
11.0	300	16.6	330	16.5
17.0	395	22.0	440	22.0
24.0	510	28.4	565	28.3
29.0	655	36.4	725	36.3
45.0	770	42.9	855	42.7
45.0	825	45.8	910	45.6
45.0	850	47.2	940	47.0
54.0	940	52.3	1040	52.0
54.0	1000	55.5	1105	55.2
54.0	1060	53.8	1170	58.5
59.0	1090	60.5	1205	60.2
59.0	1185	65.9	1310	65.6
59.0	1250	69.5	1385	69.2
74.0	1290	71.6	1425	71.2
74.0	1395	77.6	1545	77.2
74.0	1470	81.6	1625	81.2
95.0	1550	86.1	1710	85.6
95.0	1725	95.8	1905	95.3
95.0	1855	103.0	2050	102.5
95.0	1985	110.2	2195	109.7
139.0	2000	111.2	2210	110.5
139.0	2220	123.2	2450	122.5
139.0	2435	135.2	2690	134.5
139.0	2595	144.2	2870	143.5
139.0	2810	156.1	3105	155.3

*weights using standard barrel weights and weights of bells being produced.*

<sup>3</sup>*Including bell; calculated weight of pipe rounded off to nearest 5 pounds.*

<sup>4</sup>*Including bell; average weight per foot based on calculated weight of pipe before rounding.*

**Table 17 continued**  
**Standard Dimensions and Weights of**  
**Push-on Joint Ductile Iron Pipe**

Pipe Size (inches)	Pressure Class	Thickness (inches)	OD <sup>1</sup> (inches)	Weight of Barrel Per Foot (lb.)
36	150	.38	38.30	138.5
	200	.42	38.30	152.9
	250	.47	38.30	170.9
	300	.51	38.30	185.3
	350	.56	38.30	203.2
42	150	.41	44.50	173.8
	200	.47	44.50	198.9
	250	.52	44.50	219.9
	300	.57	44.50	240.7
	350	.63	44.50	265.7
48	150	.46	50.80	222.6
	200	.52	50.80	251.3
	250	.58	50.80	280.0
	300	.64	50.80	308.6
	350	.70	50.80	337.1
54	150	.51	57.56	279.7
	200	.58	57.56	317.7
	250	.65	57.56	355.6
	300	.72	57.56	393.4
	350	.79	57.56	431.1
60	150	.54	61.61	317.0
	200	.61	61.61	357.7
	250	.68	61.61	398.3
	300	.76	61.61	444.6
	350	.83	61.61	485.0
64	50	.56	65.67	350.5
	200	.64	65.67	400.1
	250	.72	65.67	449.6
	300	.80	65.67	498.9
	350	.87	65.67	542.0

<sup>1</sup>Tolerance of OD of spigot end: 3-12 inches, + 0.06 inches; 14-24 inches, + 0.05 inches, - 0.08 inches; 30-48 inches, + 0.08 inches, - 0.06 inches; 54-64 inches, + 0.04 inches, - 0.10 inches.

<sup>2</sup>The bell weights shown above are adequate for 350 psi operating pressure. Bell weights vary due to differences in push-on joint design. The manufacturer shall calculate pipe

Weight of Bell <sup>2</sup> (lb.)	18-ft Laying Length		20-ft Laying Length	
	Weight Per Length <sup>3</sup> (lb.)	Average Weight Per Foot <sup>4</sup> (lb.)	Weight Per Length <sup>3</sup> (lb.)	Average Weight Per Foot <sup>4</sup> (lb.)
184.0	2675	148.7	2955	147.7
184.0	2935	163.1	3240	162.1
184.0	3260	181.1	3600	180.1
184.0	3520	195.5	3890	194.5
184.0	3840	213.4	4250	212.4
289.0	3415	189.9	3765	188.3
289.0	3870	215.0	4265	213.3
289.0	4245	236.0	4685	234.3
289.0	4620	256.8	5105	255.2
289.0	5070	281.8	5605	280.2
354.0			4805	240.3
354.0			5380	269.0
354.0			5955	297.7
354.0			6525	326.3
354.0			7095	354.8
439.0			6035	301.7
439.0			6795	339.7
439.0			7550	377.5
439.0			8305	415.3
439.0			9060	453.1
588.0			6930	346.4
588.0			7740	387.1
588.0			8555	427.7
588.0			9480	474.0
588.0			10290	514.4
670.0			7680	384.0
670.0			8670	433.6
670.0			9660	483.1
670.0			10650	532.4
670.0			11510	575.5

*weights using standard barrel weights and weights of bells being produced.*

<sup>3</sup>*Including bell; calculated weight of pipe rounded off to nearest 5 pounds.*

<sup>4</sup>*Including bell; average weight per foot based on calculated weight of pipe before rounding.*

**Table 18****Standard Dimensions and Weights of Mechanical Joint Ductile Iron Pipe**

Pipe Size (inches)	Pressure Class	Thickness (inches)	OD <sup>1</sup> (inches)	Weight of Barrel Per Foot (lb.)
3	350	.25	3.96	8.9
4	350	.25	4.80	10.9
6	350	.25	6.90	16.0
8	350	.25	9.05	21.1
10	350	.26	11.10	27.1
12	350	.28	13.20	34.8
14	250	.28	15.30	40.4
	300	.30	15.30	43.3
	350	.31	15.30	44.7
16	250	.30	17.40	49.3
	300	.32	17.40	52.5
	350	.34	17.40	55.8
18	250	.31	19.50	57.2
	300	.34	19.50	62.6
	350	.36	19.50	66.2
20	250	.33	21.60	67.5
	300	.36	21.60	73.5
	350	.38	21.60	77.5
24	200	.33	25.80	80.8
	250	.37	25.80	90.5
	300	.40	25.80	97.7
	350	.43	25.80	104.9

<sup>1</sup>Tolerance of OD of spigot end: 3-12 inches, + 0.06 inches; 14-24 inches, + 0.05 inches, - 0.08 inches.

<sup>2</sup>The bell weights shown above are adequate for 350 psi operating pressure and are in accordance with ANSI/AWWA C111/A21.11.

Bell weights vary due to differences in bell design.

Weight of Bell <sup>2</sup> (lb.)	18-ft Laying Length		20-ft Laying Length	
	Weight Per Length <sup>3</sup> (lb.)	Average Weight Per Foot <sup>4</sup> (lb.)	Weight Per Length <sup>3</sup> (lb.)	Average Weight Per Foot <sup>4</sup> (lb.)
9.0	170	9.4	185	9.3
13.0	210	11.6	230	11.6
18.0	305	17.0	340	16.9
24.0	405	22.4	445	22.3
31.0	520	28.8	575	28.7
37.0	665	36.9	735	36.7
61.0	790	43.8	870	43.5
61.0	840	46.7	925	46.3
61.0	865	48.1	955	47.8
74.0	960	53.4	1060	53.0
74.0	1020	56.6	1125	56.2
74.0	1080	59.9	1190	59.5
85.0	1115	61.9	1230	61.5
85.0	1210	67.3	1335	66.8
85.0	1275	70.9	1410	70.5
98.0	1315	73.0	1450	72.4
98.0	1420	78.9	1570	78.4
98.0	1495	83.0	1650	82.4
123.0	1575	87.6	1740	87.0
123.0	1750	97.3	1935	96.7
123.0	1880	104.5	2075	103.8
123.0	2010	111.7	2220	111.1

*The manufacturer shall calculate pipe weights using standard barrel weights and weights of bells being produced.*

<sup>3</sup>*Including bell; calculated weight of pipe rounded off to nearest 5 pounds.*

<sup>4</sup>*Including bell; average weight per foot based on calculated weight of pipe before rounding.*



**Table 19****Pipe Thicknesses Required for Different Tap Sizes***As per ANSI/ASME B1.20.1 for Standard Taper Pipe Threads with Two, Three, and Four Full Threads*

Pipe Size (inches)	Number of Threads	Tap Size (inches)			
		Pipe Thickness (inches)			
		1/2	3/4	1	1-1/4
3	2	0.18	0.21	0.28	
3	3	0.26	0.29	0.37	
3	4	0.33	0.36	0.46	
4	2	0.17	0.19	0.26	0.31
4	3	0.25	0.27	0.35	0.40
4	4	0.32	0.34	0.44	0.49
6	2	0.17	0.18	0.23	0.27
6	3	0.25	0.26	0.32	0.36
6	4	0.32	0.33	0.41	0.45
8	2	0.16	0.17	0.22	0.24
8	3	0.24	0.25	0.31	0.33
8	4	0.31	0.32	0.40	0.42
10	2	0.15	0.17	0.21	0.23
10	3	0.23	0.25	0.30	0.32
10	4	0.30	0.32	0.39	0.41
12	2	0.15	0.16	0.20	0.22
12	3	0.23	0.24	0.29	0.31
12	4	0.30	0.31	0.38	0.40
14	2	0.15	0.16	0.20	0.22
14	3	0.23	0.24	0.29	0.31
14	4	0.30	0.31	0.38	0.40
16	2	0.15	0.16	0.20	0.21
16	3	0.23	0.24	0.29	0.30
16	4	0.30	0.31	0.38	0.39
18	2	0.15	0.15	0.19	0.21
18	3	0.23	0.23	0.28	0.30
18	4	0.30	0.30	0.37	0.39
20	2	0.15	0.15	0.19	0.20
20	3	0.23	0.23	0.28	0.29
20	4	0.30	0.30	0.37	0.38

Tap Size (inches)					
Pipe Thickness (inches)					
1-1/2	2	2-1/2	3	3-1/2	4
0.30					
0.39					
0.48					
0.27	0.33				
0.36	0.42				
0.45	0.51				
0.25	0.30	0.44			
0.34	0.39	0.56			
0.43	0.48	0.69			
0.24	0.28	0.40	0.48		
0.33	0.37	0.52	0.60		
0.42	0.46	0.65	0.73		
0.23	0.26	0.38	0.45	0.51	0.58
0.32	0.35	0.50	0.58	0.64	0.70
0.41	0.44	0.63	0.70	0.76	0.83
0.22	0.25	0.37	0.43	0.48	0.54
0.31	0.34	0.50	0.56	0.60	0.66
0.40	0.43	0.62	0.68	0.73	0.79
0.22	0.24	0.35	0.41	0.46	0.51
0.31	0.33	0.48	0.54	0.58	0.64
0.40	0.42	0.60	0.66	0.71	0.76
0.21	0.23	0.34	0.39	0.44	0.49
0.30	0.32	0.46	0.52	0.56	0.62
0.39	0.41	0.59	0.64	0.69	0.74

**Table 19 continued****Pipe Thicknesses Required for Different Tap Sizes***As per ANSI/ASME B1.20.1 for Standard Taper Pipe Threads with Two, Three, and Four Full Threads*

Pipe Size (inches)	Number of Threads	Tap Size (inches)			
		Pipe Thickness (inches)			
		1/2	3/4	1	1-1/4
24	2	0.14	0.15	0.19	0.20
24	3	0.22	0.23	0.28	0.29
24	4	0.29	0.30	0.37	0.38
30	2	0.14	0.15	0.19	0.19
30	3	0.22	0.23	0.28	0.28
30	4	0.29	0.30	0.37	0.37
36	2	0.14	0.14	0.18	0.19
36	3	0.22	0.22	0.27	0.28
36	4	0.29	0.29	0.36	0.37
42	2	0.14	0.14	0.18	0.19
42	3	0.22	0.22	0.27	0.28
42	4	0.29	0.29	0.36	0.37
48	2	0.14	0.14	0.18	0.18
48	3	0.22	0.22	0.27	0.27
48	4	0.29	0.29	0.36	0.36
54	2	0.15	0.15	0.18	0.19
54	3	0.22	0.22	0.27	0.27
54	4	0.29	0.29	0.36	0.36
60	2	0.15	0.15	0.18	0.19
60	3	0.22	0.22	0.27	0.27
60	4	0.29	0.29	0.35	0.36
64	2	0.15	0.15	0.18	0.18
64	3	0.22	0.22	0.27	0.27
64	4	0.29	0.29	0.35	0.36

Tap Size (inches)					
Pipe Thickness (inches)					
1-1/2	2	2-1/2	3	3-1/2	4
0.21	0.22	0.32	0.37	0.40	0.45
0.30	0.31	0.44	0.50	0.52	0.58
0.39	0.40	0.57	0.62	0.65	0.70
0.20	0.21	0.31	0.34	0.37	0.41
0.29	0.30	0.44	0.46	0.50	0.54
0.38	0.39	0.56	0.59	0.62	0.66
0.20	0.21	0.30	0.33	0.35	0.38
0.29	0.30	0.42	0.46	0.48	0.50
0.38	0.39	0.55	0.58	0.60	0.63
0.19	0.20	0.29	0.32	0.34	0.36
0.28	0.29	0.42	0.44	0.46	0.48
0.37	0.38	0.54	0.57	0.59	0.61
0.19	0.20	0.29	0.31	0.32	0.35
0.28	0.29	0.42	0.44	0.44	0.48
0.37	0.38	0.54	0.56	0.57	0.60
0.19	0.20	0.29	0.30	0.32	0.34
0.28	0.29	0.41	0.43	0.44	0.46
0.36	0.37	0.54	0.55	0.57	0.59
0.19	0.20	0.28	0.30	0.31	0.33
0.28	0.28	0.41	0.42	0.44	0.46
0.36	0.37	0.53	0.55	0.56	0.58
0.19	0.20	0.28	0.30	0.31	0.33
0.27	0.28	0.41	0.42	0.44	0.45
0.36	0.37	0.53	0.55	0.56	0.58

**Table 20****Pipe Thicknesses Required for Different Tap Sizes***As per AWWA C800 for Standard Corporation Stop Threads\* with Two, Three, and Four Full Threads*

Pipe Size (inches)	Number of Threads	Tap Size (inches)		
		Pipe Thickness (inches)		
		1/2	5/8	3/4
3	2	0.21	0.24	0.25
3	3	0.29	0.32	0.33
3	4	0.36	0.39	0.40
4	2	0.19	0.22	0.23
4	3	0.27	0.30	0.31
4	4	0.34	0.37	0.38
6	2	0.18	0.20	0.20
6	3	0.26	0.28	0.28
6	4	0.33	0.35	0.35
8	2	0.17	0.18	0.19
8	3	0.25	0.26	0.27
8	4	0.32	0.33	0.34
10	2	0.17	0.17	0.18
10	3	0.25	0.25	0.26
10	4	0.32	0.32	0.33
12	2	0.16	0.17	0.17
12	3	0.24	0.25	0.25
12	4	0.31	0.32	0.32
14	2	0.16	0.17	0.17
14	3	0.24	0.25	0.25
14	4	0.31	0.32	0.32
16	2	0.16	0.16	0.17
16	3	0.24	0.24	0.25
16	4	0.31	0.31	0.32
18	2	0.15	0.16	0.16
18	3	0.23	0.24	0.24
18	4	0.30	0.31	0.31
20	2	0.15	0.16	0.16
20	3	0.23	0.24	0.24
20	4	0.30	0.31	0.31
24	2	0.15	0.15	0.16
24	3	0.23	0.23	0.24
24	4	0.30	0.30	0.31
30	2	0.15	0.15	0.16
30	3	0.23	0.23	0.24
30	4	0.30	0.30	0.31

*\*The corporation stop thread is commonly known to the trade as the Mueller thread.*

Tap Size (inches)			
Pipe Thickness (inches)			
1	1-1/4	1-1/2	2
0.33			
0.41			
0.49			
0.30	0.36		
0.38	0.45		
0.46	0.54		
0.26	0.30	0.35	
0.34	0.39	0.44	
0.42	0.48	0.53	
0.24	0.27	0.31	0.39
0.32	0.36	0.40	0.48
0.40	0.45	0.49	0.57
0.23	0.25	0.28	0.35
0.31	0.34	0.37	0.44
0.39	0.43	0.46	0.53
0.22	0.24	0.26	0.32
0.30	0.33	0.35	0.41
0.38	0.42	0.44	0.50
0.21	0.23	0.25	0.30
0.29	0.32	0.34	0.39
0.37	0.41	0.43	0.48
0.21	0.22	0.24	0.28
0.29	0.31	0.33	0.37
0.37	0.40	0.42	0.46
0.20	0.21	0.23	0.27
0.28	0.30	0.32	0.36
0.36	0.39	0.41	0.45
0.20	0.21	0.23	0.26
0.28	0.30	0.32	0.35
0.36	0.39	0.41	0.44
0.19	0.21	0.22	0.24
0.27	0.30	0.31	0.33
0.35	0.39	0.40	0.42
0.19	0.20	0.21	0.23
0.27	0.29	0.30	0.32
0.35	0.38	0.39	0.41

## Table 20 continued

### Pipe Thicknesses Required for Different Tap Sizes

As per AWWA C800 for Standard Corporation Stop Threads\* with Two, Three, and Four Full Threads

Pipe Size (inches)	Number of Threads	Tap Size (inches)		
		Pipe Thickness (inches)		
		1/2	5/8	3/4
36	2	0.14	0.15	0.15
36	3	0.22	0.23	0.23
36	4	0.29	0.30	0.30
42	2	0.14	0.14	0.15
42	3	0.22	0.22	0.23
42	4	0.29	0.29	0.30
48	2	0.14	0.14	0.15
48	3	0.22	0.22	0.23
48	4	0.29	0.29	0.30
54	2	0.14	0.14	0.14
54	3	0.22	0.22	0.22
54	4	0.29	0.29	0.29
60	2	0.14	0.14	0.14
60	3	0.22	0.22	0.22
60	4	0.29	0.29	0.29
64	2	0.14	0.14	0.15
64	3	0.22	0.22	0.22
64	4	0.29	0.29	0.29

\*The corporation stop thread is commonly known to the trade as the Mueller thread.

Tap Size (inches)			
Pipe Thickness (inches)			
1	1-1/4	1-1/2	2
0.19	0.20	0.20	0.22
0.27	0.29	0.29	0.31
0.35	0.38	0.38	0.40
0.18	0.19	0.20	0.21
0.26	0.28	0.29	0.30
0.34	0.37	0.38	0.39
0.18	0.18	0.19	0.20
0.26	0.27	0.28	0.29
0.34	0.36	0.37	0.38
0.17	0.18	0.19	0.20
0.25	0.27	0.28	0.29
0.34	0.36	0.36	0.38
0.17	0.18	0.19	0.20
0.25	0.27	0.28	0.29
0.34	0.36	0.36	0.38
0.17	0.18	0.19	0.20
0.25	0.27	0.28	0.29
0.34	0.36	0.36	0.38



**Table 21**

**Nomograph for Pipe Size, Head Loss, and Discharge for Ductile Iron Pipe**

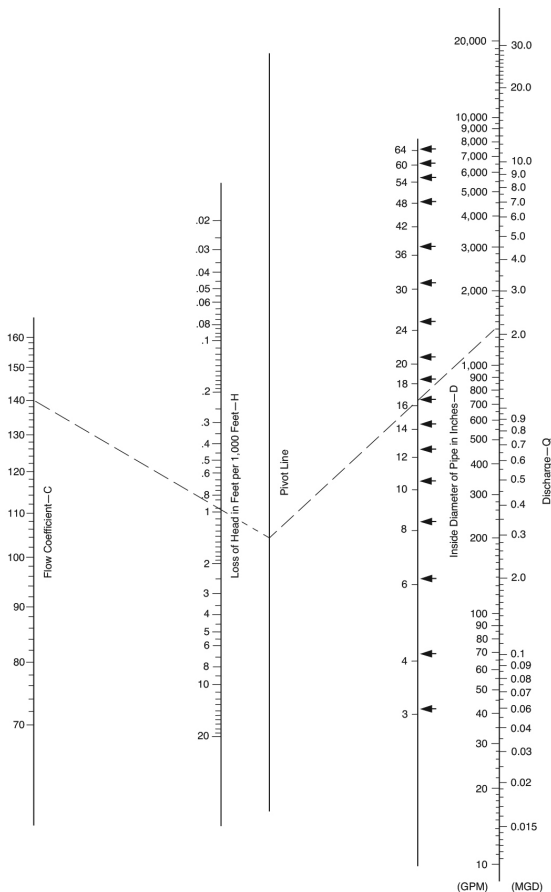

Note: Based on the Hazen-Williams formula:  
 $Q=0.006756CD^{2.63}H^{0.54}$ . For cement-mortar lined Ductile Iron Pipe,  $C=140$ . (↔) Shown are actual inside diameters of cement-mortar lined Ductile Iron Pipe of the lowest available pressure classes.

## Notes

## Index

### B

Backfilling	78
Bell Holes	23
Bells	
Cleaning	44
Direction	46
Blasting	25
Blowoffs	67
Bridge Crossings	100

### C

Casing Pipe	61
Cement-mortar lining	
Repair	8
Pressure Washing	80
Cleanup	79
Coatings	14
Coefficient of Linear Expansion	107
Conversion Factors	108
Corrosive Soil	28
Cutting Pipe	58

### D

Deflection	
Mechanical Joints	54
Push-on Joints	56
Delivery to Trench Site	17
Dimensions	
Mechanical Joint Pipe	118
Push-on Joint Pipe	114
Disinfecting	
Continuous-feed Method	87
Slug Method	88
Tablet Method	85

### E

Other Utilities	19
-----------------	----

<b>F</b>	
Fittings	15
Flanged Joints	54
Flushing	80
<b>G</b>	
Gas Services	20
Gaskets	15
<b>H</b>	
Handling Pipe Into Trench	45
Highway Crossings	61
Hydrants	
Anchorage	69
Drainage	68
Inspecting	67
Installation	67
Hydrostatic Pressure Testing	83
<b>I</b>	
Inspection	8
Insulation	101
<b>J</b>	
Joints	
Deflection	54
Flanged	54
Mechanical	51
Push-on	48
Restrained	73
<b>L</b>	
Laying Conditions, Standard	42
Lifting Devices	
Hooks	13
Pipe Tongs	13
Slings	13
Linear Expansion	107

<b>M</b>	
Mechanical Joints	51
Metallized Zinc	
See Zinc	30
<b>P</b>	
Pavement	
Removal	21
Replacement	79
Pipe on Supports	100
Pipe Plugs	47
Planning, Pre-construction	18
Polyethylene Encasement	29
Pressure Testing	83
Push-on Joints	48
<b>R</b>	
Railroad Crossings	61
Repairing Pipe	90
Restrained Joints	73
Rock Excavation	24
<b>S</b>	
Safety	26
Sewers	20
Shipments	9
Shoring	26
Soil	
Corrosive	28
Expansive	27
Special Installations	
Bridge Crossings	100
Pipe on Supports	100
Pipe through Walls	97
Subaqueous Crossings	97
Stacking Pipe	14
Standards	
List	104
Organizations	106

Subaqueous Crossings	97
<b>T</b>	
Taps	
Large Connections	95
Maximum Size	93
Required Wall Thickness per ANSI/ASME B1.20.1	120
Required Wall Thickness per AWWA C800	124
Testing	
Testing Allowance	82
Pressure	83
Thawing, Electrical	63
Thrust	
Blocks	71
Forces	70
Tie Rods	76
Transition Couplings	57
Trench	
Bottom	22
Box	26
Excavation	21
Width	23
<b>U</b>	
Unloading	
Railcars	11
Trucks	10
<b>V</b>	
V-Bio®	
Enhanced Polyethylene Encasement	29
Valves	
Inspecting	64
Installing	64
Operation	65
Thrust Restraint	65
Vents	67

**W**

## Weights

Mechanical Joint Pipe 118

Push-on Joint Pipe 114

**Z**

Metallized Zinc 30

## Notes



## Notes



For more information contact DIPRA or any of its member companies.

## Ductile Iron Pipe Research Association

An association of quality producers dedicated to the highest pipe standards through a program of continuing research and service to water and wastewater professionals.

P.O. Box 190306  
Birmingham, AL 35219  
205.402.8700 Tel  
[www.dipra.org](http://www.dipra.org)

## Member Companies

AMERICAN Ductile Iron Pipe  
P.O. Box 2727  
Birmingham, AL 35202-2727  
[www.american-usa.com](http://www.american-usa.com)

Canada Pipe Company, Ltd.  
55 Frid Street, Unit #1  
Hamilton, ON, L8P 4M3 Canada  
[www.canadapipe.com](http://www.canadapipe.com)

McWane Ductile  
P.O. Box 6001  
Coshocton, Ohio 43812-6001  
[www.mcwaneductile.com](http://www.mcwaneductile.com)

U.S. Pipe  
Two Chase Corporate Drive  
Suite 200  
Birmingham, AL 35244  
[www.uspipe.com](http://www.uspipe.com)

## Social Media

Get in the flow with Ductile Iron Pipe by connecting with us on [Facebook](#), [Twitter](#), and [LinkedIn](#).

Visit our website, [www.dipra.org](http://www.dipra.org), and click on the YouTube icon for informational videos on Ductile iron pipe's ease of use, economic benefits, strength and durability, advantages over PVC, and more.



Copyright © 2021 by Ductile Iron Pipe Research Association  
ISBN 978-0-9642194-2-7

**Strength and Durability for LiFe®**