

INSTALLATION GUIDE - RIDGE DETAILING

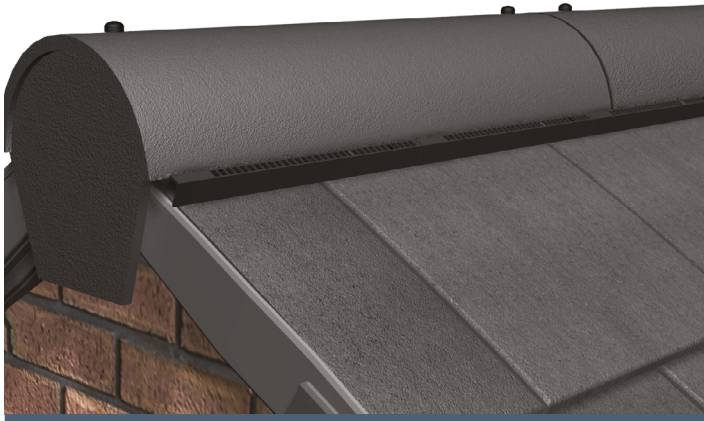

Flat Tile Vented Ridge Pack 6m

Providing 5000mm²/linear metre Free Vent Area
Conforms to the requirements of BS 8612

You will need a cross head screwdriver/drill bit to install this system.

- 1) Lay the underlay in accordance with BS 5534. Before fixing the top tiling batten, fix a ridge batten bracket to the top of each truss using 25mm aluminium nails on either side (Picture 1). The brackets should be fixed such that 20mm penetration into the ridge batten is achievable when fixing the ridge tiles. Fix the top tiling batten.

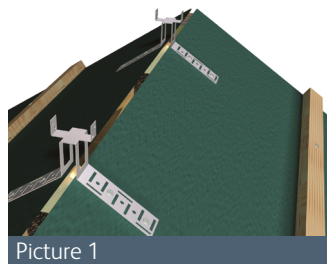

- 5) Place a ridge seal under the block end ridge and locate into the channels of the top fillers (Picture 5).
- 6) Secure the block end ridge using 2 x 80mm screws, washers and grommets provided.

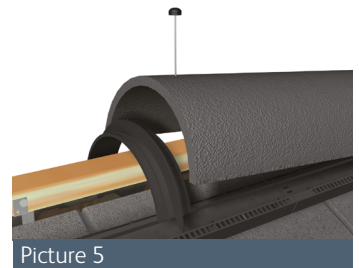

- 2) Locate a 25x50mm ridge batten into the ridge batten brackets and fix using 20mm nails on either side. Additional ridge battens should be spliced diagonally over a ridge batten bracket (Picture 2).

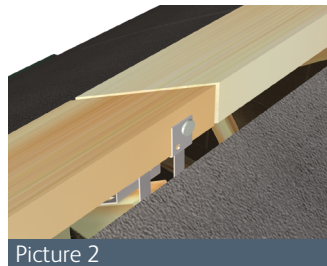

- 7) Continue fixing nailhole ridge tiles, top fillers and ridge seals along the ridge. If cutting is necessary to maintain the aesthetics of the ridge line, the block end ridge must not be cut. Ridge tiles must not be cut to less than half of their original length. All ridge tiles must be twice fixed with fixings supplied (re-drill nailholes if necessary). At the verge, trim the last top fillers and fix the block end ridge tile as described in step 6 to finish the ridge line (Picture 6).

- 3) Lay roof tiles in accordance with BS 5534.

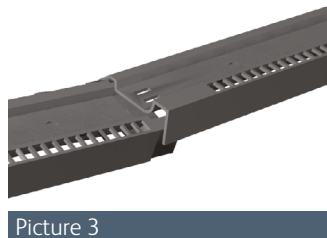

- 4) Snap together 3 top fillers to form a track for either side of the ridge (Picture 3). Locate a nailhole block end ridge tile into the tracks centrally over the ridge line. The top fillers must be positioned with the smaller ventilation voids on the outside of the ridge tile (Picture 4).

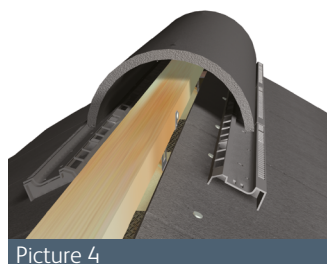

INSTALLATION GUIDE - RIDGE DETAILING

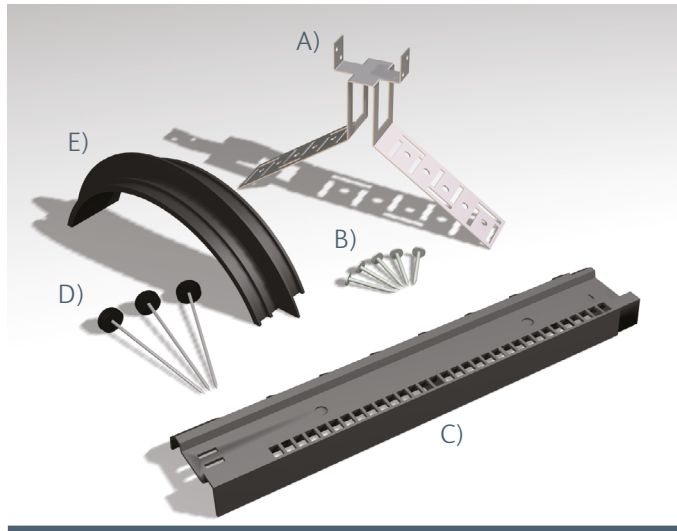

Flat Tile Vented Ridge Pack 6m (GMT5)

- A) 10 no. Steel Ridge Batten Brackets
- B) 40 no. 25mm Aluminium Nails
- C) 40 no. Top Fillers
- D) 28 no. 80mm S/S Screws, S/S & Rubber Washers, Grommets
- E) 13 no. Ridge Seals

Colours available - Grey or Rustic

Conforms to the requirements of BS:8612

Plastic Type: Polypropylene

Fixings should be assembled as shown below:



Fixing installation examples:

