

LA GARD Mechanical Price list

J5 | August 2024



Table of Contents

- Limited Warranty 3
- Terms and Conditions of Sale 4
- LA GARD Mechanical Series 8
 - 3390 3-Wheel combination lock 9
 - 1985 3-Wheel combination lock 10
 - 1947 4-Wheel combination lock 10
 - 3330 3- Wheel combination lock 10
 - 2270 Key lock 11
 - Dial & dial ring assemblies 13
 - Dial components & accessories 14

Limited Warranty

dormakaba USA, Inc. warrants to the original purchaser that the product(s) shall be free of defects in material and workmanship for a period of two (2) years from the date of manufacture by dormakaba (finished goods), and sixty (60) days (parts). This warranty applies provided there is compliance with all installation/operating instructions supplied by dormakaba and, provided further, that the product has been subject to normal use without any misuse, negligence, modification, or the occurrence of any accidental damage.

In the event of a defect in materials or workmanship covered by this warranty, the purchaser shall return, at purchaser's expense, the product to dormakaba for repair or replacement. Repair or replacement shall be at the election of dormakaba. The purchaser's sole remedy shall be the repair or replacement of the product. UNDER NO CIRCUMSTANCES SHALL dormakaba BE LIABLE TO PURCHASER OR ANY OTHER PERSON FOR ANY CONSEQUENTIAL, INCIDENTAL, ECONOMIC, INDIRECT, GENERAL OR SPECIAL DAMAGES. In no event shall dormakaba's liability exceed the original cost of the product.

This warranty and remedies set forth above are exclusive and in lieu of all others, oral or written, expressed or implied. EXCEPT AS OTHERWISE SPECIFICALLY SET FORTH HEREIN dormakaba DOES NOT MAKE, AND HEREBY DISCLAIMS, ANY AND ALL WARRANTIES, EXPRESS OR IMPLIED, INCLUDING WITHOUT LIMITATION IMPLIED WARRANTIES OF MERCHANTABILITY, FITNESS FOR A PARTICULAR USE OR PURPOSE, AND NON-INFRINGEMENT. No dealer, distributor, agent or employee is authorized to make any modification or addition to this warranty.

Some states do not allow the exclusion or limitation of implied warranties or limitation of liability for incidental or consequential damages, so the above limitation or exclusion may not apply to you.

NOTICE

Installation of the product with any unapproved accessory item or product may invalidate the dormakaba USA, Inc. Limited Product Warranty.

Terms and Conditions of Sale

1. Acceptance. The following Terms and Conditions of sale are applicable to all Quotations, Contract, Purchase Orders, Order Acknowledgment Forms, and sales of Seller's services and products, and are the only applicable terms and conditions thereto, except for terms establishing prices, quantities, delivery schedules, terms of payment, invoicing, shipping instructions, and the identification of the products associated with each transaction. If any conflict exists between the Terms and Conditions and a Quotation, Purchase Order, Order Acknowledgment form, or sale, these Terms and Conditions shall prevail BY REQUESTING A QUOTATION OF ORDERING ANY PRODUCTS OR SERVICES FROM SELLER, BUYER AGREES TO ALL THE FOLLOWING TERMS AND CONDITIONS. If a written contract signed by both parties is in existence covering the sale of the goods and services, the terms and conditions of the contract shall control to the extent they are inconsistent with these Terms and Conditions.
2. Order Procedure. Buyer may or may not request the preparation of a Quotation prior to ordering any products or services from Seller. Buyer then shall place a Purchase Order with Seller. By placing a Purchase Order, Buyer makes an offer to purchase products or services from Seller pursuant to these Terms and Conditions. Seller, in its discretion, may accept or reject the Purchase Order. If Seller accepts the Purchase Order, Seller shall issue an Order Acknowledgment Form confirming Buyer's order. No Purchase Order is binding on Seller unless accepted by Seller as provided in these Terms and Conditions.
3. Quotations. All Quotations by Seller are subject to change or withdrawal without prior notice to Buyer unless otherwise specifically stated in the Quotation. All resulting Purchase Orders become effective only if and when approved and accepted in writing by Seller by the issuance of its Order Acknowledgment Form. Seller reserves the right to discontinue manufacture of any products or change products materials, design, or specifications without notice.
4. Site Requirements.
 - a. The Quotation is contingent upon all work being performed during normal business hours unless otherwise negotiated and a mutually agreeable schedule. The Quotation is calculated on one continuous installation engagement based on acceptable site conditions where other dependent scopes have completed preparation for proposed materials (i.e. electrical work, floor work, adjacent construction). When Buyer has given authorization for work to begin, no other scopes may impede Seller's ability to complete installation in agreed upon area. Seller reserves the right to invoice for costs that are incurred due to unacceptable site conditions or delays by others resulting in additional installation visits.
 - b. Signed acceptance by Buyer of shop drawings and/or submittals shall be interpreted as acceptance that proposed scope is the correct interpretation of construction documents. Any field verification and/or work required by others as detailed in the submittal will be provided and coordinated by Buyer. Work shall not begin nor shall orders be placed for any projects until all shop drawings and submittals have been approved in writing by Buyer.
5. Warranty. Unless specified otherwise by Seller in writing, for a period of two (2) years from the date of manufacture, Seller warrants only that all products sold pursuant to a Quotation or Purchase Order will conform to the description in this Price Book and will be free from defects in workmanship and materials. Extended warranties are available for an additional cost. Seller is not responsible for defects or damages caused by wear and tear, consumable materials, vandalism, fires, storms, floods, acts of God, misuse, abuse or alteration by any company other than Seller. Seller further warrants that Buyer will receive good and valid title to the products. Any claim on account of

nonconforming or defective products or for any other cause whatsoever shall conclusively be deemed waived by Buyer unless written notice thereof is given to Seller promptly after discovery but no later than sixty (60) days from date of shipment. Seller shall have the right either to replace or repair any nonconforming or defective products, to refund the purchase price upon return of the products, or to grant a reasonable allowance on account of such nonconformance or defect Seller's liability and Buyer's exclusive remedy for nonconforming or defective products shall be limited solely to replacement, repair, refund, or allowance as Seller may elect. Seller shall be given reasonable opportunity to investigate all claims and no materials shall be returned to Seller until after inspection and approval by Seller and receipt by Buyer of written shipping instructions from Seller. Buyer acknowledges and agrees that the remedies set forth in this paragraph are Buyer's exclusive remedies for the delivery of nonconforming or defective products.

Additional Warranties

- a. No credit will be provided for any work completed by others during warranty term.
- b. Warranty work will be performed during normal business hours with our standard response times. Any warranty work taking place beyond normal business hours or with expedited response time may be billable.
- c. Products repaired or replaced under the warranty are warranted only through the remainder of the original warranty period.

Disclaimer of Further Warranties. EXCEPT AS SET FORTH ABOVE, THERE IS NO WARRANTY, REPRESENTATION, OR CONDITION OF ANY KIND, EXPRESS OR IMPLIED (INCLUDING NO WARRANTY OF MERCHANTABILITY OR FITNESS OF THE PRODUCTS FOR ANY USE CONTEMPLATED BY BUYER) CONCERNING SELLER'S PRODUCTS OR SERVICES AND NONE SHALL BE IMPLIED BY LAW.

6. Limitation of Liability and Remedies. SELLER SHALL NOT BE LIABLE, AND BUYER WAIVES ALL CLAIMS AGAINST SELLER FOR ANY INCIDENTAL, CONSEQUENTIAL, OR SPECIAL DAMAGES, INCLUDING WITHOUT LIMITATION, LOST REVENUES AND PROFITS EVEN IF SELLER HAS BEEN ADVISED OF THE POSSIBILITY OF SUCH DAMAGES. Buyer's exclusive remedy for any cause of action under these Terms and Conditions is a claim for damages and in no event will damages or any other recovery of any kind against Seller exceed the purchase price of the specific products or services as to which the claim is made. Seller will not be liable to Buyer for any loss, damage, or injury to persons or property resulting from the handling, storage, transportation, resale, or use of the products in manufacturing processes, or in combination with other substances, or otherwise.
7. Intellectual Property Indemnification. (a) Seller agrees to defend, indemnify and hold Buyer harmless against any claims, costs, damages, liability and expenses resulting from actual or alleged patent, trademark, or copyright infringement, misappropriation of confidential information, or violation of any other intellectual property right, domestic or foreign, in the selling or use of any part or product that is owned by Seller and that pertains to the subject matter of a Quotation, Purchase Order, or sale of products or services (provided that the product is not modified in anyway by Buyer or any other party, and that the product is used in the manner intended by Seller). If a suit or claim results in any injunction or any other order that would prevent Seller from supplying any product falling under a Quotation, Purchase Order, or sale, or if the result of such a suit or claim would, in the reasonable opinion of Seller, otherwise cause Seller to be unable to supply such products, Seller shall have the right, at its option, if it so chooses, to do one or more of the following: (i) secure an appropriate license to permit Seller to continue supplying the products to Buyer; (ii) modify the relevant product so that it becomes non-infringing, provided that any modification does not cause any material change to the operation or performance of the product; or (iii) replace the relevant product with a non-infringing but practically equivalent product. (b) Buyer agrees to defend, indemnify, and hold Seller harmless against any claims, costs, damages, liability and expenses resulting from actual or alleged patent, trademark, or copyright infringement, misappropriation of confidential information, or violation of any other intellectual property right, domestic or foreign, in the making, using or selling of any product or using any process that is owned by Buyer or is designed or specified by Buyer and that pertains to the subject matter of a Quotation, Purchase Order, or sale.
8. Ownership of Inventions. All drawings, know-how, designs, confidential information, and the like disclosed to Buyer by Seller and all rights therein will remain the property of Seller. Buyer shall have no claim to, ownership interest in, no license to, or no rights to any information provided or communicated by Seller.

9. Lead Times. If applicable, lead times are based on standard requirements by factory to provide materials proposed. Ship dates will be provided as estimate only once order is placed with the factory. Adequate packaging will be provided for any normal shipping circumstance such that materials will be protected and labeled as required. Special packaging may be provided for an additional expense. Shipping will be cost effective unless expedited fees are accepted by Buyer. Unless mutually agreed upon in writing, shipping dates are approximate and are based upon prompt receipt of all necessary information.
10. Title/Risk of Loss. Title and risk of loss or damage to the goods shall pass to Buyer upon delivery Ex Works Seller's warehouse unless otherwise agreed to in writing by Seller.
11. Incoterms. All freight terms shall be EX Works unless otherwise agreed upon. For Ex Works the Seller will make the goods available at the warehouse site for the Buyers' collections, any claims for damage in transit or lost freight, receiving, and inspection of materials is the responsibility of Buyer. It is a requirement of Buyer to inspect and review all materials prior to accepting shipment. Seller reserves the right to ship items in a single or in multiple shipments.
12. Prices. Quoted price is valid for 90 days. Seller reserves the right to revise quotations after the 90 days. All accepted Purchase Orders are subject to Seller's price in effect at time of shipment. Buyer shall be responsible for any increase in freight rates or transportation charges occurring after Seller have prepared the Order Acknowledgment Form. Buyer shall pay to Seller in addition to the purchase price the amount of all fees, duties, licenses, and all sales, use, privilege, occupation, excise, or other taxes, federal, state, local, or foreign which Seller is required to pay or collect in connection with products or services sold to Buyer.
13. Payments. Unless otherwise agreed in writing between the parties, all Seller's invoices are payable within thirty (30) days of their date. Time is of the essence. Interest on past due amounts will be assessed at the rate of 1.5% per month (18% per annum), or the maximum allowable by law.

Seller reserves the right to full payment upon completion of work unless credit is pre-established. For any work requiring materials purchase or scheduling, a 50% deposit is due at time of proposal acceptance. Twenty percent (20%) of the Quotation, Purchase Order value may be billed after job award. Joint check agreements may be requested at the discretion of Seller. If payment is outstanding for any one account, work may be stopped and outstanding orders canceled until account is restored. Should Seller require the use of collection, attorney's fees, or fees for insufficient funds, Buyer agrees that these funds will be repaid to Seller. Seller retains the right to file a lien against all or part of the property being improved. Seller reserves the right to add a 2.5% charge if invoice becomes delinquent beyond terms.

14. Cancellation. In the event a Buyer's Purchase Order and the issuance of an Order Acceptance Form is canceled, it will be subject to standard 20% restocking fees, cancellation fees, engineering fees, materials & freight costs incurred, and administrative fees. Standard cancellation is 20% of order as long as no materials have been ordered. Should Buyer release material orders, Buyer will be liable for that portion of the job and 20% of the remaining amount of work unperformed/unordered.
15. Storage. If applicable, Seller reserves the right to implement a storage fee if delivery is delayed after agreed upon date. Should project timeline require storage of materials, Seller reserves the right to bill for those materials at the time they have been received at a Seller location, Buyer location, or at job site. Certificate of insurance for stored materials can be provided to Buyer upon request.
16. Insolvency. Seller may, at any time or times, suspend performance of any order or require payment in cash, security, or other adequate assurance satisfactory to Seller when, in Seller's opinion, the financial condition of Buyer or other grounds for insecurity, including the filing of a petition for bankruptcy, warrant such action.
17. Force Majeure. Seller shall not be liable for any delay in fulfilling any order due to (a) fires, floods, strikes, or other labor disputes, accidents to machinery, acts of sabotage, riots, precedence or priorities granted at the request or for the benefit, directly or indirectly, of the federal or any state government or any subdivision or agency thereof, delays in transportation or lack of transportation facilities, restrictions imposed by federal or state legislation or rules of regulations thereunder; or (b) any cause beyond the control of Seller.

18. Ownership of Equipment. Unless otherwise agreed in a writing, all material, equipment, facilities, and special tooling, which term includes but is not limited to jigs, dies, fixtures, molds, patterns, special taps, special gauges, special test equipment, and manufacturing aids and replacements thereof, used in the manufacture of the products covered by any order shall remain the property of Seller. Any material, tooling, and equipment furnished to Seller by Buyer shall be and remain the personal property of Buyer with the title to and right of possession remaining in Buyer.
19. Confidential Information. All information furnished or made available by Seller to Buyer in connection with a transaction shall be held in confidence by Buyer. Buyer agrees not to use such information or disclose such information to others without Seller's prior written consent. The obligations of this paragraph does not apply to any information which (a) at the time of disclosure was, or thereafter becomes, generally available to the public by publication or otherwise through no breach by Buyer of any obligation herein, (b) Buyer can show by written records was in Buyer's possession prior to disclosure by the disclosing party, (c) is legally made available to Buyer by or through a third party having no direct or indirect confidentiality obligation to Seller with respect to such information, (d) was independently developed by Buyer without use of any of Seller's confidential information, or (e) is required to be disclosed pursuant to applicable law.
20. Waiver. No waiver by Seller of any of these Terms and Conditions shall be effective unless explicitly set forth in writing and signed by Seller. No failure to exercise, or delay in exercising, any rights, remedy, power, or privilege arising from these Terms and Conditions shall operate or be construed as a waiver thereof, nor shall any single or partial exercise of any right, remedy, power, or privilege hereunder preclude any other or further exercise thereof or the exercise of any other right, remedy, power or privilege.
21. Assignment. No assignment of any right or interest or delegation of any obligation or performance of Buyer under this order may be made without the prior written consent of Seller. Any attempted assignment or delegation will be wholly void and totally ineffective for all purposes.
22. Choice of Law. All sales, agreements for sale, offers to sell, proposals, acknowledgments and contracts of sale, including, but not limited to, Purchase Orders accepted by Seller, shall be considered a contract under the laws of the State of Delaware, and the rights and duties of all persons, and the construction and effect of all provisions hereof, shall be governed by and construed according to the laws of the State of Delaware.
23. Integration Clause. These Terms and Conditions constitute the entirety of terms and conditions, except as set forth in paragraph one, governing the sale and purchase of products and services sold by Seller. No modification of these Terms and Conditions shall be of any force or effect unless in writing and signed Seller and Buyer. Buyer may desire to utilize its own form of acknowledgment or acceptance of these Terms and Conditions. However, the use of any such form shall be for convenience only. No modification of these Terms and Conditions shall be affected by the acknowledgment or acceptance of purchase orders, shipping instruction forms, bills of lading or any other document containing terms or conditions at variance with or in addition to those set forth herein, all such varying or additional terms being hereby objected to and rejected by Seller and deemed to be waived by Buyer.



LA GARD™ Mechanical series

Mechanical

- 3390 - Group 2M, 3-Wheel Combination Lock
- 1985 - Group 1, 3-Wheel Combination Lock
- 1947 - Group 1, 4-Wheel Combination Lock
- 3330 - Group 2, 3-Wheel Combination Lock
- 2270 - Key Lock
- Dials, Dial Rings
- Components

New Lock Identification Numbering (LIN) System - 3390 Series

Step 1: Select Model

3	3	9	0
---	---	---	---

Step 2: Select Certification Agency

Z

Step 3: Not used for this series

Step 4: Select Switch Options

Step 5: Select Bolt

Step 6: Not used for this series

Z	Z	Z
---	---	---

Step 7: Select Relocker Option

Step 8: Select Install Kit

Step 9: Select Packaging

Mechanical

3390 3-Wheel combination lock

Model	Description	LIN (Lock Identification Number)	List
3390	3 Wheel Group 2M Combination Mechanical	3390xxxxxxxxxx	64.60
Certification Agency	Description	LIN (Lock Identification Number)	List
S	UL/Vds Class 1/EN1300 Class A	xxxxSxxxxxxxxxx	standard
V*	UL/VdS Class 2/EN1300 Class B	xxxxVxxxxxxxxxx	6.53
*Switch options N or K must be selected to comply with VdS Class 2 Certification			
Not Used	Description	LIN (Lock Identification Number)	List
Z	Not Used In This Series	xxxxxZxxxxxxxxxx	no add
Switches	Description	LIN (Lock Identification Number)	List
D	Top Duress w/ W Harn & Bolt Sw P/N 707108	xxxxxDxxxxxxxxxx	77.64
N	No Switch	xxxxxNxxxxxxxxxx	no add
A	Top Duress Only	xxxxxAxxxxxxxxxx	38.82
C	Top Duress & Bolt Switch	xxxxxCxxxxxxxxxx	77.64
E	Bottom Duress Only	xxxxxExxxxxxxxxx	38.82
G	Bottom Duress & Bolt Switch	xxxxxGxxxxxxxxxx	77.64
K	Bolt Switch Only	xxxxxKxxxxxxxxxx	38.82
B	Top Duress w/ Wire Harness	xxxxxBxxxxxxxxxx	41.82
F	Top Duress w/ Harn & Bolt Sw	xxxxxFxxxxxxxxxx	77.64
H	Bottom Duress w/ Wire Harness	xxxxxHxxxxxxxxxx	77.64
M	Bot. Duress, Sw Opt, Spec Conn	xxxxxMxxxxxxxxxx	77.64
Bolt	Description	LIN (Lock Identification Number)	List
00	Standard Bolt (1.5")	xxxxxx00xxxxxxxx	no add
03	Metric Tapped Bolt M4 (1.5")	xxxxxx03xxxxxxxx	3.85
05	US Tapped Bolt 10-32 (1.5")	xxxxxx05xxxxxxxx	3.85
20	EXT Bolt (2.4")	xxxxxx20xxxxxxxx	7.71
Not Used	Description	LIN (Lock Identification Number)	List
ZZZ	Not Used In This Series	xxxxxxxZZZxxx	no add
Relocker	Description	LIN (Lock Identification Number)	List
Y	Universal Relocker Kit	xxxxxxxxxxxYxx	12.13
N	No Relocker	xxxxxxxxxxxNxx	no add
Install	Description	LIN (Lock Identification Number)	List
0	No Hardware	xxxxxxxxxxx0x	deduct 2.38
1	STD Hardware	xxxxxxxxxxx1x	Standard
2	Metric Hardware	xxxxxxxxxxx2x	Standard
Packaging	Description	LIN (Lock Identification Number)	List
A	Distributor (Individual)	xxxxxxxxxxxAx	3.58
B**	OEM (Bulk)	xxxxxxxxxxxB	Standard

**24 per master carton

EXAMPLE

3	3	9	0	S	Z	N	0	0	Z	Z	Z	N	1	B
Model				Approval	N/A	Switch	Bolt		N/A			Relocker	Install	Packaging

Mechanical

1985 3-Wheel combination lock

1947 4-Wheel combination lock

3330 3- Wheel combination lock

Combination locks - without dials & rings

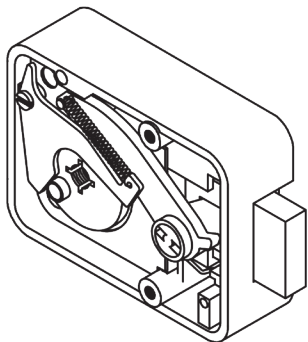

Part Number	Description	Price
1985	Group 1, 3-Wheel Lock	93.05
1985000-03-00	Group 1, 3-Wheel Lock, with Metric Tapped Bolt (M4)	97.19
1985A000-00-00	Group 1, 3-Wheel Lock, with Relock Cover	106.08
1985E000-00-00	Group 1, 3-Wheel Lock, with Duress Switch	132.16
1985F000-00-00	Group 1, 3-Wheel Lock, with Bolt Switch	132.16
Part Number	Description	Price
1947	Group 1, 4-Wheel Lock	103.41
19470000-03-00	Group 1, 4-Wheel Lock with Metric Tapped Bolt (M4)	107.56
1947E000-00-00	Group 1, 4-Wheel Lock with Duress Switch	142.22
1947F000-00-00	Group 1, 4-Wheel Lock with Bolt Switch	142.22

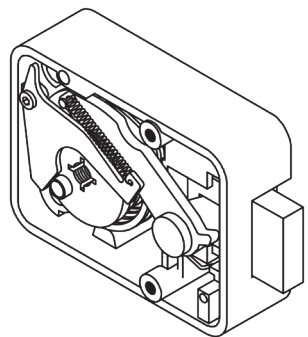

Part Number	Description	Price
3330	Group 2, 3 wheel combo LK, 3330	67.26
33300000-03-00	33300000-03-00, GRP23 WHL CMB LK	71.11
3330C000-00-00	3330c000-00-00, GRP23 WHLCMBLK DURESS	144.89
3330-D	3330-d, GR 23WHLCMB, DIEB 17423A LAB	60.75
3330-D1	3330-d1, gr23 WHL CMB, DIEB 17423HA LAB	54.23
3330G000-00-00	3330g000-00-00, gp23 WHL CMB DUR& BT SW	144.89
3330Q000-00-00	3330q000-00-00, GP23WHLCOMBO LK CUTAWAY	77.64

Mechanical

2270 Key lock

Key locks - without keys

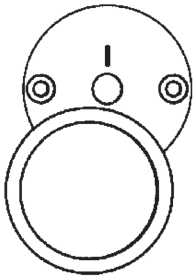
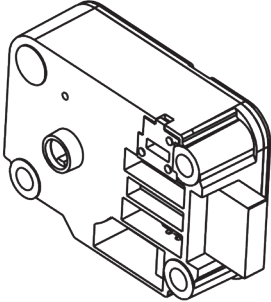

Part Number	Description	Price
2270	Key Lock	103.41
22700000-00-14	Key Lock, Metric Hardware	103.41
22700000-03-00	Key Lock with Metric Tapped Bolt (M4)	107.27
22700000-03-14	Key Lock with Metric Tapped Bolt (M4), Metric Hardware	107.27
2270F000-00-00	Key Lock with Bolt Switch	142.22
2270F000-00-14	Key Lock with Bolt Switch, Metric Hardware	142.22
2270F000-03-00	Key Lock with Bolt Switch, Metric Tapped Bolt (M4)	146.38
2270F000-03-14	Key Lock with Bolt Switch, Metric Tapped Bolt (M4), Metric Hardware	146.38

Keys sold separately

Part Number	Description	Price
2226	Key Hole Cover	35.56

Key lock components

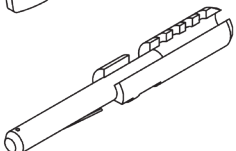
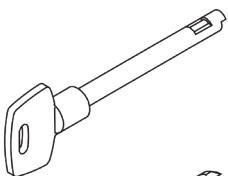
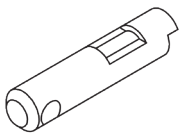
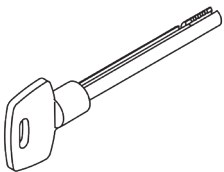
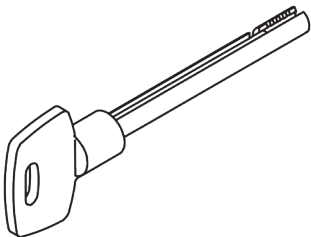

Part Number	Description	Price
2212-02	3" Keys, Random Cut (Pairs)	42.67
2217-02	4" Keys, Random Cut (Pairs)	42.67
2218-02	5" Keys, Random Cut (Pairs)	42.67
2242-1-02	6" Keys, Random Cut (Pairs)	50.39

Part Number	Description	Price
2213	Set-up Key	21.94

Part Number	Description	Price
2278	Key Sheath	24.60

Part Number	Description	Price
2280	Key Extension Handle 12" Long	46.83

Part Number	Description	Price
2282-02	Key Tips, Random Cut (Pairs)	54.52

Mechanical

Dials, dial rings & components

Dial & dial ring assemblies

Additional Spindle Lengths and Options are available.

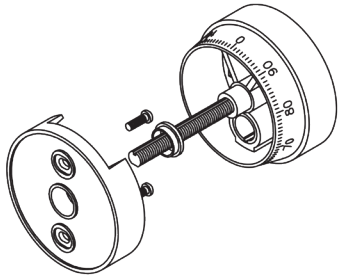

Part Number	Description	Price
1730	Restrict-A-Vision - Satin Chrome	49.19
1730SC000875001	Restrict-A-Vision - Satin Chrome w/ 7.50" Spindle	68.46
1730SC001275001	Restrict-A-Vision - Satin Chrome w/ 11.50" Spindle	88.00
1730BK000000001	Restrict-A-Vision - Black & White	42.67

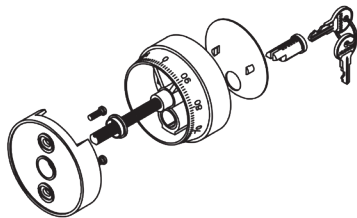

Part Number	Description	Price
1731	Restrict-A-Vision, Key Locking - Satin Chrome	54.23
1731SC0008750A1	Restrict-A-Vision, Key Locking, Satin Chrome w/ 7.50" Spindle	73.78
1731SC0012750A1	Restrict-A-Vision, Key Locking Satin Chrome w/ 11.50" Spindle	93.05
1731BK00000000A1	Restrict-A-Vision, Key Locking - Black & White	48.01

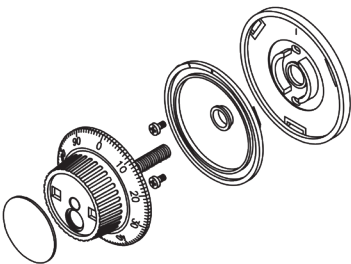

Part Number	Description	Price
1777	Flat Gard - Satin Chrome	42.67
1777SC000875001	Flat Gard - Satin Chrome w/ 7.50" Spindle	62.23
1777SC001275001	Flat Gard - Satin Chrome w/ 11.50" Spindle	81.48
1777BK0000000003	Flat Gard - Black & White	36.16

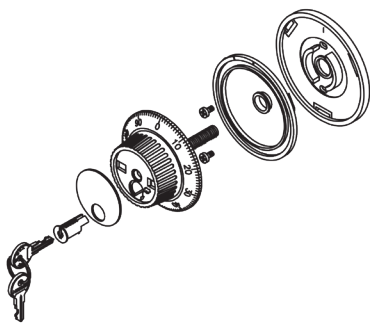

Part Number	Description	Price
1779	Flat Gard, Key Locking - Satin Chrome	48.01
1779SC0008750A1	Flat Gard, Key Locking - Satin Chrome w/ 7.50" Spindle	67.26
1779SC0012750A1	Flat Gard, Key Locking - Satin Chrome w/ 11.50" Spindle	86.82

Mechanical

Dials, dial rings & components

Dial & dial ring assemblies

Additional Spindle Lengths and Options are available.

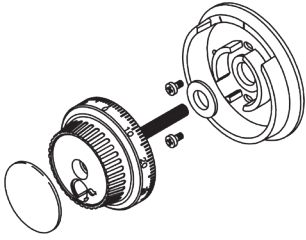

Part Number	Description	Price
2085-SC	VisionGard Dial & Ring - Satin Chrome w/ 3.95" Spindle	63.41
2085SC000875001	VisionGard Dial & Ring - Satin Chrome w/ 7.50" Spindle	82.97
2085SC001275001	VisionGard, Dial & Ring - Satin Chrome w/ 11.50" Spindle	102.22
2085-BC	VisionGard Dial & Ring - Bright Chrome w/ 3.95" Spindle	76.45
2085-B	VisionGard Dial & Ring - Black & White w/ 3.95" Spindle	56.89
2085-BB	Vision Gard Dial & Ring - Bright Brass w/ 3.95" Spindle	111.70
2085-BP	Vision Gard Dial & Ring - Black Platinum w/ 3.95" Spindle	121.71
2085-AU	Vision Gard Dial & Ring - Bright Brass w/ 3.95" Spindle	Quote

Available without dial insert

Part Number	Description	Price
2085BK010875001	Vision Gard Dial and Ring -Black w/ 7.5" Spindle No Insert	77.00
2085BK011275001	Vision Gard Dial and Ring -Black w/ 11.5" Spindle No Insert	97.00
2085BP010875001	Vision Gard Dial and Ring- Black Platinum w/ 7.5" Spindle No Insert	141.71
2085BP011275001	Vision Gard Dial and Ring- Black Platinum w/ 11.5" Spindle No Insert	161.71
2085BB010875001	Vision Gard Dial and Ring- Bright Brass w/ 7.5" Spindle No Insert	131.70
2085BB011275001	Vision Gard Dial and Ring- Bright Brass w/ 11.5" Spindle No Insert	151.70
2085BC010875001	Vision Gard Dial and Ring Bright Chrome w/ 7.5" Spindle No Insert	113.05
2085BC011275001	Vision Gard Dial and Ring Bright Chrome w/ 11.5" Spindle No Insert	133.05
2085SC010875001	Vision Gard Dial and Ring Satin Chrome w/ 7.5" Spindle No Insert	81.00
2085SC011275001	Vision Gard Dial and Ring Satin Chrome w/ 11.5" Spindle No Insert	101.00

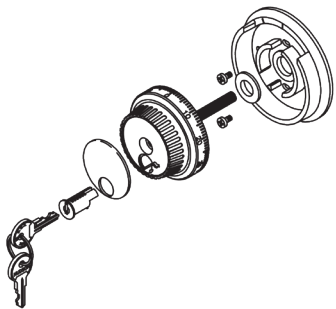

Part Number	Description	Price
2089-1	Dial Insert Black No Logo	8.30
2089-3	Standard Dial Insert Black Logo	6.22

Part Number	Description	Price
2090-SC	VisionGard Key Locking Dial & Ring w/ 3.95" Spindle Satin Chrome	68.46
2090SC0008750A1	VisionGard Key Locking Dial & Ring Satin Chrome w/ 7.50" Spindle	88
2090SC0512750A1	VisionGard Key Locking Dial & Ring Satin Chrome w/ 11.50" Spindle	107.56
2090-BC	VisionGard Key Locking Dial & Ring w/ 3.95" Spindle Bright Chrome	81.48
2090-B	VisionGard Key Locking Dial & Ring w/ 3.95" Spindle Black & White	74.05
2090-BB	VisionGard Key Locking Dial & Ring w/ 3.95" Spindle Bright Brass	116.74
2090-BP	VisionGard Key Locking Dial & Ring w/ 3.95" Spindle Black Platinum	126.75
2090-AU	VisionGard Key Locking Dial & Ring w/ 3.95" Spindle Gold	Quote

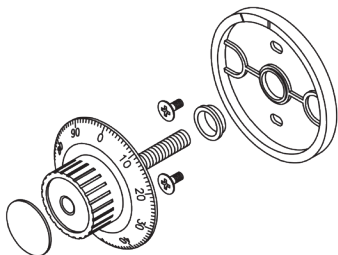

Part Number	Description	Price
2089-2	Dial Insert Black No Logo With Keyhole	8.30
2089-4	Standard Dial Insert Black Logo With Keyhole	8.01

Part Number	Description	Price
2107	Small Dial & Dial Ring - Satin Chrome	32.3
2107BK000000003	Small Dial & Dial Ring - Black & White	25.79

Mechanical

Dials, dial rings & components

Dial components & accessories

Additional Spindle Lengths and Options are available.

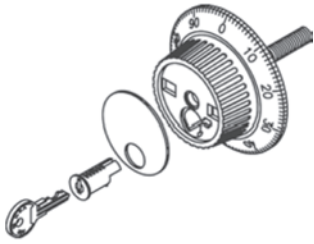

Part Number	Description	Price
1762	Flat Gard Dial Only, Key Locking Satin Chrome	32.30

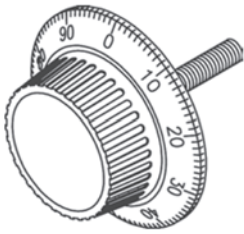

Part Number	Description	Price
1763	Flat Gard Dial Only - Satin Chrome	25.79

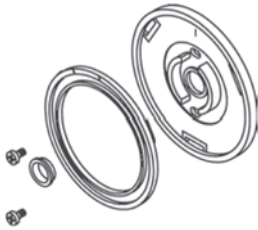

Part Number	Description	Price
1764	Dial Ring Only	21.94

Mechanical

Dials, dial rings & components

Dial components & accessories

Additional Spindle Lengths and Options are available.

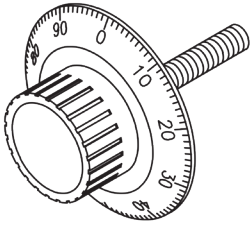

Part Number	Description	Price
2107	Small Dial & Ring	32.30
2107BK000000003	Small Dial & Ring Black	25.79

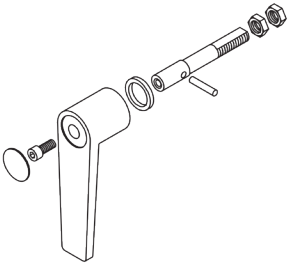

Part Number	Description	Price
2300	Handle Assembly with Stem Satin Chrome	40.90

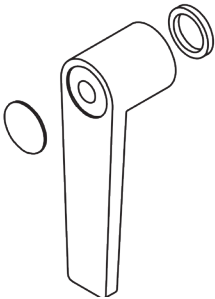

Part Number	Description	Price
2301	Handle Assembly without Stem Satin Chrome	23.41

NOTE: Minimum order amount per shipment is 100.00 net.

How can we help you?

Any questions? We would be happy to advise you.

Contact us: sales.safelocks.us@dormakaba.com

dormakaba USA Inc. | 1525 Bull Lea Road, Suite 100 | Lexington, KY 40511 | +1 800 950 4744 | +1 888 950 4715 (tech support) | dormakaba.com

LAGARD.Mechanical.08.07.24