

FLENDER COUPLINGS

FASTEX

Compact assembly and operating instructions 3902en

Edition 05/2022

FASTEX IC120

FLENDER

FLENDER

FLENDER COUPLINGS

FASTEX IC120 Clamping elements 3902en

Compact assembly and
operating instructions

Introduction	1
Description	2
Application planning	3
Assembly	4
Disassembly	5
Disposal	6
Services and support	7
Technical data	A

Legal information

Warning notice system

This manual contains notices you have to observe in order to ensure your personal safety, as well as to prevent damage to property. The notices referring to your personal safety are highlighted in the manual by a safety alert symbol, notices referring only to property damage have no safety alert symbol. These notices shown below are graded according to the degree of danger.

 DANGER
indicates that death or severe personal injury will result if proper precautions are not taken

 WARNING
indicates that death or severe personal injury may result if proper precautions are not taken.

 CAUTION
indicates that minor personal injury can result if proper precautions are not taken.

NOTICE
indicates that property damage can result if proper precautions are not taken.

If more than one degree of danger is present, the warning notice representing the highest degree of danger will be used. A notice warning of injury to persons with a safety alert symbol may also include a warning relating to property damage.

Qualified Personnel

The product/system described in this documentation may be operated only by **personnel qualified** for the specific task in accordance with the relevant documentation, in particular its warning notices and safety instructions. Qualified personnel are those who, based on their training and experience, are capable of identifying risks and avoiding potential hazards when working with these products/systems.

Proper use of Flender products

Note the following:

 WARNING
Flender products may only be used for the applications described in the catalog and in the relevant technical documentation. If products and components from other manufacturers are used, these must be recommended or approved by Flender. Proper transport, storage, installation, assembly, commissioning, operation and maintenance are required to ensure that the products operate safely and without any problems. The permissible ambient conditions must be complied with. The information in the relevant documentation must be observed.

Trademarks

All names identified by ® are registered trademarks of Flender GmbH. The remaining trademarks in this publication may be trademarks whose use by third parties for their own purposes could violate the rights of the owner.

Disclaimer of Liability

We have reviewed the contents of this publication to ensure consistency with the hardware and software described. Since variance cannot be precluded entirely, we cannot guarantee full consistency. However, the information in this publication is reviewed regularly and any necessary corrections are included in subsequent editions.

Table of contents

1	Introduction	5
1.1	Main operation instructions	5
1.2	General information	5
1.3	Intended use	6
1.4	Safety instructions for a clamping element for use in potentially explosive atmospheres	6
2	Description	7
3	Application planning	8
3.1	Transport of the clamping element.....	8
3.1	Storage of the clamping element.....	8
4	Assembly	9
4.1	Assembling the clamping element.....	10
5	Disassembly	11
6	Disposal	12
7	Service und support	12
A	Technical data	13
A.1	Geometry data and tightening torques	13

Tables

Table 1-1	General warnings	5
Table 4-1	Recommended assigned fits	9
Table 7-1	Geometry data, weights, tightening torques.....	14

Figures

Figure 2-1	Construction of the clamping element FASTEX IC120	7
Figure 4-1	Fit assignment	9
Figure 7-1	Parts overview FASTEX IC120	13

1 Introduction

1.1 Main operation instructions

These instructions are only valid in conjunction with the associated operating instructions from the component supplier.

1.2 General information

Instructions











Notice the information and regulations in these installation instructions and in the main operating instructions from the component supplier.

Please make sure that every person who is commissioned to work on the clamping element has read and understood these instructions prior to handling the clamping element and observes all of the points.

Only the knowledge of these instructions can avoid faults on the clamping element and ensure fault-free and safe operation. Non-adherence to the instructions can cause product or property damage or personal injury. Flender does not accept any liability for damage or operating failures that are due to non-adherence to these instructions.

Symbols

Table 1-1 General warnings

ISO	ANSI	Warning
		Warning - hazardous electrical voltage
		Warning - explosive substances
	---	Warning - entanglement hazard
	---	Warning - hot surfaces
	---	Warning - substances that are harmful to health or are irritants
	---	Warning - corrosive substances
	---	Warning - suspended load
	---	Warning - hand injuries
		ATEX certification

Explanation regarding Machinery Directive 2006/42/EG

The clamping elements described here are components in accordance with the Machinery Directive and do not require a declaration of incorporation.

Work on the clamping element

Only carry out work on the clamping element when it is not in operation and is not under load. Secure the drive unit against being switched on accidentally. Attach a notice to the switch stating clearly that work is being carried out on the clamping element. Ensure that the entire unit is not under load..

1.3 Intended use

Only use the clamping element according to the conditions specified in the service and delivery contract and the technical data in the annex. Deviating operating conditions are considered improper use. The user or owner of the machine or plant is solely liable for any resulting damage.

When using the clamping element please specifically observe the following:

- Do not make any modifications to the clamping element that go beyond the permissible machining described in these instructions. This also applies to touch protection facilities.
- Do not use the clamping element as a torque-limiting safety element.

If you have any queries, please contact our customer service (see Service and support (Page 12)).

1.4 Safety instructions for a clamping element for use in potentially explosive atmospheres



The assembly supplier is responsible for the guideline-compliant design of the system clamping element with all associated components. In potentially explosive areas, it must be ensured that the design torque T_{Cl} according to Table 7-1 is not exceeded at any operating point. The identification and information on the conditions of use can be found in the main operating instructions of the assembly supplier.

2 Description

The clamping elements described here are universally applicable, self-centering clamping elements whose function is the tensionally locked transmission of torque between shaft and hub.

The installation and operation of the specified clamping elements in combination with cylindrically bored hubs is described in these instructions.

Design

Detailed information on the dimensions can be found in Appendix A Technical data (Page 13).

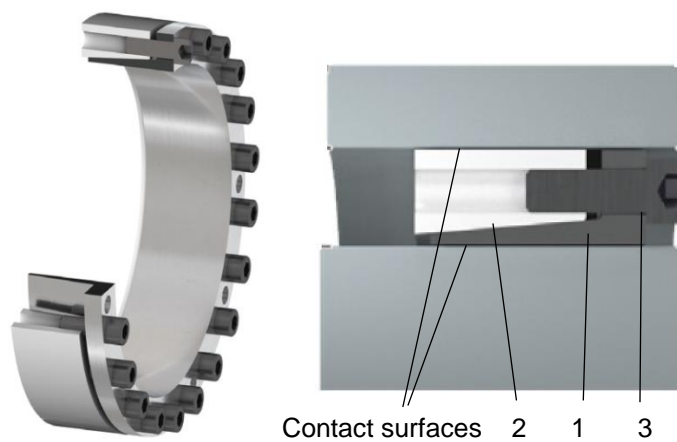

- 1 Clamping hub
- 2 Clamping bush
- 3 Cylinder-head screw

Figure 2-1 Construction of the clamping element FASTEX IC120

3 Application planning

Check the delivery for damage and for completeness. Report any damage and/or missing parts to Flender immediately.

The coupling is delivered in preassembled groups. These may be dismantled.

3.1 Transport of the clamping element



WARNING

Severe personal injury due to improper transport

Severe personal injury due to falling components or due to crushing. Damage to clamping element parts possible due to use of unsuitable transport means.

- Only use lifting gear and load suspension devices with sufficient load bearing capacity for transport.
- Please observe the symbols applied on the packaging.

3.1 Storage of the clamping element

The clamping element, unless not specifically ordered otherwise, is supplied with preservation and can be stored for up to 12 months in a dry and dust-free storage room.

4 Assembly



DANGER

Danger due to bursting of the assembly group

If not used as intended, the assembly can burst. There is a risk of fatal injury from flying fragments. Bursting of the assembly can lead to an explosion in potentially explosive atmospheres.

- Use the clamping element as intended

Note

Information about the assembly of the clamping element

- Only use undamaged components for the assembly of the clamping element.
- Follow the assembly sequence.
- Please ensure that there is sufficient space at the assembly location and that the location is tidy and clean in order to be able to assemble and maintain the clamping element without any risk.
- If a dimension drawing has been created for the clamping element, please observe the information it contains as a matter of priority

Recommended assigned fits

In the following table you will find the permissible fits of the clamping element and the shaft.

Table 4-1 Recommended assigned fits

component	tolerance	surface quality
Shaft tolerance	h8	$R_a \leq 3,2 \mu\text{m}$
Bore tolerance	H8	$R_a \leq 3,2 \mu\text{m}$

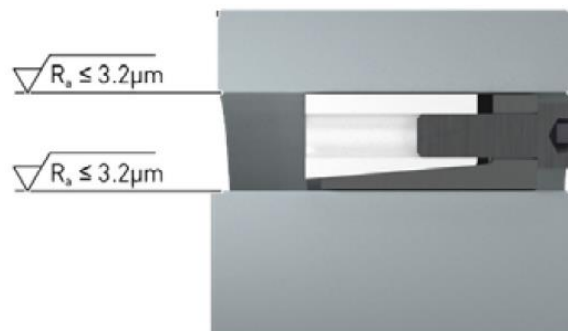

Figure 4-1 Fit assignment

4.1 Assembling the clamping element



WARNING

The design torque T_{C1} must not be exceeded at any operating point. It must be ensured that the cylinder head bolts are tightened with the tightening torques according to Table 7-1

Preparatory work

1. Make sure the surfaces to be joined are in perfect condition.
2. Clean the contact surfaces as well as the shaft and hub.
3. Slightly oil the contact surfaces. Do not use any grease or oil that contains molybdenum disulfide or other additives that significantly reduce the coefficient of friction.
4. Place the clamping bush (2) on the clamping hub (1). Position the clamping bush (2) so that the release threads are offset to the slot in the clamping hub (1).
5. Screw the clamping hub (1) to the clamping bush (2) without tightening the cylinder-head screws (3).

Assemble

1. Position the pre-assembled clamping element in the hub bore and then place both parts on the shaft.
2. Slightly tighten the cylinder-head screws (3) so that the clamping element can still be moved.
3. Align the Clamping element on the shaft.
4. The shaft must fill the entire length of the clamping hub (1).
5. Tighten the cylinder-head screws (3) crosswise in several turns. The specified tightening torque can be found in the Tightening torques and widths A/F section.

5 Disassembly

Procedure

1. Loosen and remove all cylinder-head screws (3) one after the other.
2. Screw the cylinder-head screws (3) into the existing release threads of the clamping hub (1).
3. Remove the clamping element. Use suitable lifting gear when doing this.
4. Check the hub bore and the shaft for damage and protect them against corrosion.

When reinstalling the clamping element please observe the information in the chapter Assembly (Page 10).

6 Disposal

Dispose of the clamping element parts according to applicable national regulations or recycle them.

7 Service und support

When ordering spare parts, requesting a customer service technician or in the case of technical queries, please contact our factory or one of our customer service addresses:

Flender GmbH

Schlavenhorst 100

46395 Bocholt

Deutschland

Tel.: +49 (0)2871/92-0

Fax.: +49 (0)2871/92-2596

Flender GmbH (<http://www.flender.com>)

A Technical data

A.1 Geometry data and tightening torques

In this section you can find dimension drawings and technical data for the Flender clamping elements.:

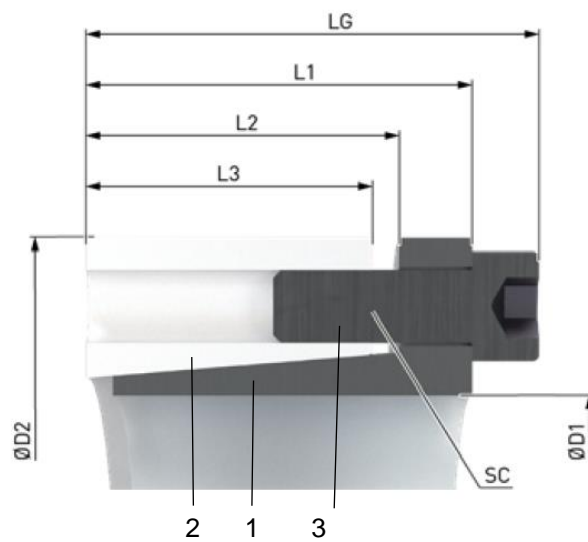

- 1 Clamping hub
- 2 Clamping bush
- 3 Cylinder-head screw

Figure 7-1 Parts overview FASTEX IC120

Table 7-1 Geometry data, weights, tightening torques

Size	Dimensions				Limit Torque	Hexagon socked-head screws aac. to DIN EN ISO 4762 - 12.9					Weight
						Screw size	Tightening torque	Quantity	Screwlength	widht A/F	
D ₁ x D ₂	L _G	L ₁	L ₂	L ₃	T _{Cl}	SC	T _A		L _S	SW	m
mm	mm	mm	mm	mm	Nm	mm	Nm		mm	mm	kg
18 x 47	34	28	22	17	370	M6	14	6	20	5	0,28
19 x 47	34	28	22	17	390	M6	14	6	20	5	0,27
20 x 47	34	28	22	17	410	M6	14	6	20	5	0,26
22 x 47	34	28	22	17	450	M6	14	6	20	5	0,25
24 x 50	34	28	22	17	490	M6	14	6	20	5	0,28
25 x 50	34	28	22	17	510	M6	14	6	20	5	0,27
28 x 55	34	28	22	17	570	M6	14	6	20	5	0,32
30 x 55	34	28	22	17	610	M6	14	6	20	5	0,30
32 x 60	34	28	22	18	880	M6	14	8	20	5	0,37
35 x 60	34	28	22	18	960	M6	14	8	20	5	0,34
38 x 65	34	28	22	18	1000	M6	14	8	20	5	0,41
40 x 65	34	28	22	18	1100	M6	14	8	20	5	0,38
42 x 75	41	33	25	20	2200	M8	35	8	25	6	0,63
45 x 75	41	33	25	20	2400	M8	35	8	25	6	0,63
48 x 80	41	34	24	20	2500	M8	35	8	25	6	0,69
50 x 80	41	34	24	20	2600	M8	35	8	25	6	0,68
55 x 85	41	34	24	20	2900	M8	35	8	25	6	0,73
60 x 90	41	34	24	20	3100	M8	35	8	25	6	0,78
65 x 95	41	34	24	20	3400	M8	35	8	25	6	0,84
70 x 110	50	40	29	24	6000	M10	70	8	30	8	1,53
75 x 115	50	40	29	24	6400	M10	70	8	30	8	1,63
80 x 120	50	40	29	24	6800	M10	70	8	30	8	1,72
85 x 125	50	40	29	24	9000	M10	70	10	30	8	1,83
90 x 130	50	40	29	24	9600	M10	70	10	30	8	1,90
95 x 135	50	40	29	24	10200	M10	70	10	30	8	2,00
100 x 145	56	44	31	26	12000	M12	115	8	30	10	2,60
110 x 155	56	44	31	26	13000	M12	115	8	30	10	2,80
120 x 165	56	44	31	26	16000	M12	115	9	30	10	3,60
130 x 180	64	52	39	34	23000	M12	115	12	30	10	4,40
140 x 190	68	54	39	34	25000	M14	185	9	40	12	4,90
150 x 200	68	54	39	34	30000	M14	185	10	40	12	5,20
160 x 210	68	54	39	34	38800	M14	185	12	40	12	5,60
170 x 225	78	64	49	44	41300	M14	185	12	40	12	6,90
180 x 235	78	64	49	44	43700	M14	185	12	40	12	8,50
190 x 250	78	64	49	44	57700	M14	185	15	40	12	9,00
200 x 260	78	64	49	44	60700	M14	185	15	40	12	9,60
220 x 285	88	72	57	50	78100	M16	290	12	40	14	13,42
240 x 305	88	72	57	50	106500	M16	290	15	40	14	14,46
260 x 325	88	72	57	50	138500	M16	290	18	40	14	16,11
280 x 355	102	84	66	60	160300	M18	400	16	60	14	23,44
300 x 375	102	84	66	60	193200	M18	400	18	60	14	25,28
320 x 405	121	101	81	74	272700	M20	580	18	74	17	36,94
340 x 425	121	101	81	74	338000	M20	580	21	74	17	39,00
360 x 455	138	116	93	86	375700	M22	780	18	86	17	54,00
380 x 475	138	116	93	86	462700	M22	780	21	86	17	56,20
400 x 495	138	116	93	86	487000	M22	780	21	86	17	58,85

FASTEX IC120
Compact assembly and operating instructions 3902de
Edition 05/2022

[Flender GmbH](#)
Alfred-Flender-Straße 77
46395 Bocholt
Germany