

# FLENDER COUPLINGS

---

FASTEX

---

Compact assembly and operating instructions 3906en

Edition 05/2022

---

FASTEX IC230

---

**FLENDER**

# FLENDER

## FLENDER COUPLINGS

### FASTEX IC230 Clamping elements 3906en

Compact assembly and  
operating instructions

<b>Introduction</b>	<b>1</b>
<b>Description</b>	<b>2</b>
<b>Application planning</b>	<b>3</b>
<b>Assembly</b>	<b>4</b>
<b>Disassembly</b>	<b>5</b>
<b>Disposal</b>	<b>6</b>
<b>Services and support</b>	<b>7</b>
<b>Technical data</b>	<b>A</b>

## Legal information

### Warning notice system

This manual contains notices you have to observe in order to ensure your personal safety, as well as to prevent damage to property. The notices referring to your personal safety are highlighted in the manual by a safety alert symbol, notices referring only to property damage have no safety alert symbol. These notices shown below are graded according to the degree of danger.

 <b>DANGER</b>
indicates that death or severe personal injury <b>will</b> result if proper precautions are not taken

 <b>WARNING</b>
indicates that death or severe personal injury <b>may</b> result if proper precautions are not taken.

 <b>CAUTION</b>
indicates that minor personal injury can result if proper precautions are not taken.

<b>NOTICE</b>
indicates that property damage can result if proper precautions are not taken.

If more than one degree of danger is present, the warning notice representing the highest degree of danger will be used. A notice warning of injury to persons with a safety alert symbol may also include a warning relating to property damage.

### Qualified Personnel

The product/system described in this documentation may be operated only by **personnel qualified** for the specific task in accordance with the relevant documentation, in particular its warning notices and safety instructions. Qualified personnel are those who, based on their training and experience, are capable of identifying risks and avoiding potential hazards when working with these products/systems.

### Proper use of Flender products

Note the following:

 <b>WARNING</b>
Flender products may only be used for the applications described in the catalog and in the relevant technical documentation. If products and components from other manufacturers are used, these must be recommended or approved by Flender. Proper transport, storage, installation, assembly, commissioning, operation and maintenance are required to ensure that the products operate safely and without any problems. The permissible ambient conditions must be complied with. The information in the relevant documentation must be observed.

### Trademarks

All names identified by ® are registered trademarks of Flender GmbH. The remaining trademarks in this publication may be trademarks whose use by third parties for their own purposes could violate the rights of the owner.

### Disclaimer of Liability

We have reviewed the contents of this publication to ensure consistency with the hardware and software described. Since variance cannot be precluded entirely, we cannot guarantee full consistency. However, the information in this publication is reviewed regularly and any necessary corrections are included in subsequent editions.

# Table of contents

<b>1</b>	<b>Introduction</b> .....	<b>5</b>
1.1	Main operation instructions .....	5
1.2	General information .....	5
1.3	Intended use .....	6
1.4	Safety instructions for a clamping element for use in potentially explosive atmospheres .....	6
<b>2</b>	<b>Description</b> .....	<b>7</b>
<b>3</b>	<b>Application planning</b> .....	<b>8</b>
3.1	Transport of the clamping element .....	8
3.1	Storage of the clamping element .....	8
<b>4</b>	<b>Assembly</b> .....	<b>9</b>
4.1	Assembling the clamping element .....	10
<b>5</b>	<b>Disassembly</b> .....	<b>11</b>
<b>6</b>	<b>Disposal</b> .....	<b>12</b>
<b>7</b>	<b>Service und support</b> .....	<b>12</b>
<b>A</b>	<b>Technical data</b> .....	<b>13</b>
A.1	Geometry data and tightening torques .....	13

## Tables

Table 1-1	General warnings .....	5
Table 4-1	Recommended assigned fits .....	9
Table 7-1	Geometry data, weights, tightening torques .....	14

## Figures

Figure 2-1	Construction of the clamping element FASTEX IC230 .....	7
Figure 4-1	Fit assignment .....	9
Figure 7-1	Parts overview FASTEX IC230 .....	13

# 1 Introduction

## 1.1 Main operation instructions

These instructions are only valid in conjunction with the associated operating instructions from the component supplier.

## 1.2 General information

### Instructions











Notice the information and regulations in these installation instructions and in the main operating instructions from the component supplier.

Please make sure that every person who is commissioned to work on the clamping element has read and understood these instructions prior to handling the clamping element and observes all of the points.

Only the knowledge of these instructions can avoid faults on the clamping element and ensure fault-free and safe operation. Non-adherence to the instructions can cause product or property damage or personal injury. Flender does not accept any liability for damage or operating failures that are due to non-adherence to these instructions.

### Symbols

Table 1-1 General warnings

ISO	ANSI	Warning
		Warning - hazardous electrical voltage
		Warning - explosive substances
	---	Warning - entanglement hazard
	---	Warning - hot surfaces
	---	Warning - substances that are harmful to health or are irritants
	---	Warning - corrosive substances
	---	Warning - suspended load
	---	Warning - hand injuries
		ATEX certification

## Explanation regarding Machinery Directive 2006/42/EG

The clamping elements described here are components in accordance with the Machinery Directive and do not require a declaration of incorporation.

### Work on the clamping element

Only carry out work on the clamping element when it is not in operation and is not under load. Secure the drive unit against being switched on accidentally. Attach a notice to the switch stating clearly that work is being carried out on the clamping element. Ensure that the entire unit is not under load..

## 1.3 Intended use

Only use the clamping element according to the conditions specified in the service and delivery contract and the technical data in the annex. Deviating operating conditions are considered improper use. The user or owner of the machine or plant is solely liable for any resulting damage.

When using the clamping element please specifically observe the following:

- Do not make any modifications to the clamping element that go beyond the permissible machining described in these instructions. This also applies to touch protection facilities.
- Do not use the clamping element as a torque-limiting safety element.

If you have any queries, please contact our customer service (see Service and support (Page 12)).

## 1.4 Safety instructions for a clamping element for use in potentially explosive atmospheres



The assembly supplier is responsible for the guideline-compliant design of the system clamping element with all associated components. In potentially explosive areas, it must be ensured that the design torque  $T_{Cl}$  according to Table 7-1 is not exceeded at any operating point. The identification and information on the conditions of use can be found in the main operating instructions of the assembly supplier.

## 2 Description

The clamping elements described here are universally applicable, self-centering clamping elements whose function is the tensionally locked transmission of torque between shaft and hub.

The installation and operation of the specified clamping elements in combination with cylindrically bored hubs is described in these instructions.

### Design

Detailed information on the dimensions can be found in Appendix A Technical data (Page 13).

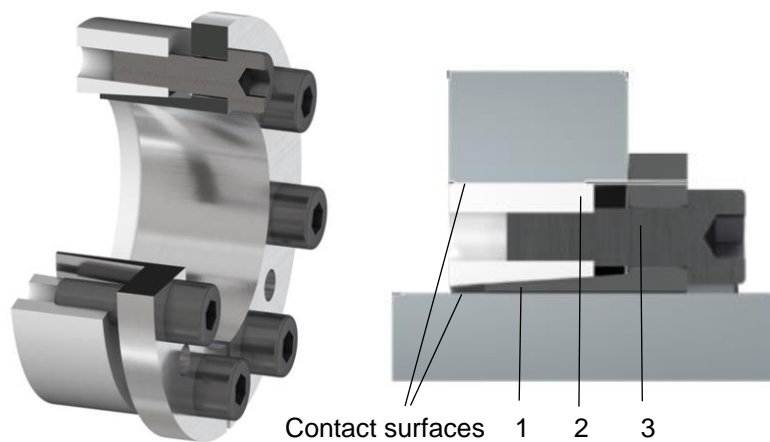

- 1 Clamping hub
- 2 Clamping bush
- 3 Cylinder-head screw

Figure 2-1 Construction of the clamping element FASTEX IC230

### 3 Application planning

Check the delivery for damage and for completeness. Report any damage and/or missing parts to Flender immediately.

The coupling is delivered in preassembled groups. These may be dismantled.

#### 3.1 Transport of the clamping element



##### **WARNING**

##### **Severe personal injury due to improper transport**

Severe personal injury due to falling components or due to crushing. Damage to clamping element parts possible due to use of unsuitable transport means.

- Only use lifting gear and load suspension devices with sufficient load bearing capacity for transport.
- Please observe the symbols applied on the packaging.

#### 3.1 Storage of the clamping element

The clamping element, unless not specifically ordered otherwise, is supplied with preservation and can be stored for up to 12 months in a dry and dust-free storage room.



# 4 Assembly



 <b>DANGER</b>
<p><b>Danger due to bursting of the assembly group</b></p> <p>If not used as intended, the assembly can burst. There is a risk of fatal injury from flying fragments. Bursting of the assembly can lead to an explosion in potentially explosive atmospheres.</p> <ul style="list-style-type: none"> <li>• Use the clamping element as intended</li> </ul>

**Note**

**Information about the assembly of the clamping element**

- Only use undamaged components for the assembly of the clamping element.
- Follow the assembly sequence.
- Please ensure that there is sufficient space at the assembly location and that the location is tidy and clean in order to be able to assemble and maintain the clamping element without any risk.
- If a dimension drawing has been created for the clamping element, please observe the information it contains as a matter of priority

## Recommended assigned fits

In the following table you will find the permissible fits of the clamping element and the shaft.

Table 4-1 Recommended assigned fits

component	tolerance	surface quality
Shaft tolerance	h8	Ra ≤ 3,2 μm
Bore tolerance	H8	Ra ≤ 3,2 μm

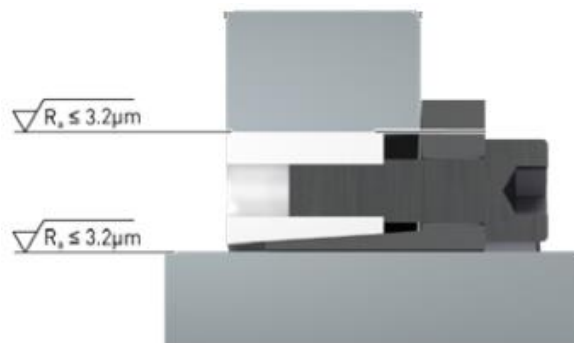

Figure 4-1 Fit assignment

## 4.1 Assembling the clamping element



### **WARNING**

The design torque  $T_{C1}$  must not be exceeded at any operating point. It must be ensured that the cylinder head bolts are tightened with the tightening torques according to Table 7-1

### **Preparatory work**

1. Make sure the surfaces to be joined are in perfect condition.
2. Clean the contact surfaces as well as the shaft and hub.
3. Slightly oil the contact surfaces. Do not use any grease or oil that contains molybdenum disulfide or other additives that significantly reduce the coefficient of friction.
4. Place the clamping bush (2) on the clamping hub (1). Position the clamping bush (2) so that the release threads are offset to the slot in the clamping hub (1).
5. Screw the clamping hub (1) to the clamping bush (2) without tightening the cylinder-head screws (3).

### **Assemble**

1. Position the pre-assembled clamping element in the hub bore and then place both parts on the shaft.
2. Slightly tighten the cylinder-head screws (3) so that the clamping element can still be moved.
3. Align the Clamping element on the shaft.
4. The shaft must fill the entire length of the clamping hub (1).
5. Tighten the cylinder-head screws (3) crosswise in several turns. The specified tightening torque can be found in the Tightening torques and widths A/F section.

# 5 Disassembly

## Procedure

1. Loosen and remove all cylinder-head screws (3) one after the other.
2. Screw the cylinder-head screws (3) into the existing release threads of the clamping hub (1).
3. Remove the clamping element. Use suitable lifting gear when doing this.
4. Check the hub bore and the shaft for damage and protect them against corrosion.

When reinstalling the clamping element please observe the information in the chapter Assembly (Page 10).

## 6 Disposal

Dispose of the clamping element parts according to applicable national regulations or recycle them.

## 7 Service und support

When ordering spare parts, requesting a customer service technician or in the case of technical queries, please contact our factory or one of our customer service addresses:

Flender GmbH

Schlavenhorst 100

46395 Bocholt

Deutschland

Tel.: +49 (0)2871/92-0

Fax.: +49 (0)2871/92-2596

Flender GmbH (<http://www.flender.com>)

# A Technical data

## A.1 Geometry data and tightening torques

In this section you can find dimension drawings and technical data for the Flender clamping elements.:

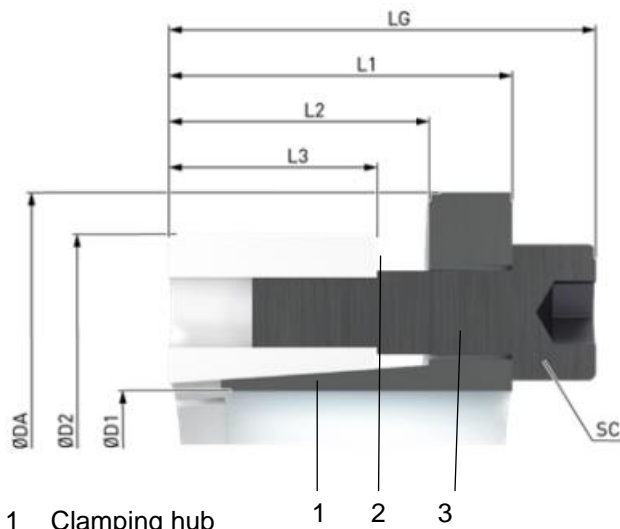

- 1 Clamping hub
- 2 Clamping bush
- 3 Cylinder-head screw

Figure 7-1 Parts overview FASTEX IC230

Table 7-1 Geometry data, weights, tightening torques

Size	Dimensions					Limit Torque	Hexagon socked-head screws aac. to DIN EN ISO 4762 - 12.9					Weight
							Screw size	Tightening torque	Quantity	Screwlength	widht A/F	
D <sub>1</sub> x D <sub>2</sub>	D <sub>A</sub>	L <sub>G</sub>	L <sub>1</sub>	L <sub>2</sub>	L <sub>3</sub>	T <sub>Cl</sub>	SC	T <sub>A</sub>		L <sub>S</sub>	SW	m
mm	mm	mm	mm	mm	mm	Nm	mm	Nm		mm	mm	kg
14 x 55	62	38	30	22	17	287	M8	41	4	25	6	0,50
16 x 55	62	38	30	22	17	329	M8	41	4	25	6	0,49
18 x 55	62	38	30	22	17	370	M8	41	4	25	6	0,48
19 x 55	62	38	30	22	17	390	M8	41	4	25	6	0,47
20 x 55	62	38	30	22	17	410	M8	41	4	25	6	0,46
22 x 55	62	38	30	22	17	451	M8	41	4	25	6	0,45
24 x 55	62	38	30	22	17	492	M8	41	4	25	6	0,43
25 x 55	62	38	30	22	17	513	M8	41	4	25	6	0,42
28 x 55	62	38	30	22	17	575	M8	41	4	25	6	0,39
30 x 55	62	38	30	22	17	616	M8	41	4	25	6	0,35
24 x 65	72	38	30	22	17	616	M8	41	5	25	6	0,66
25 x 65	72	38	30	22	17	641	M8	41	5	25	6	0,65
28 x 65	72	38	30	22	17	718	M8	41	5	25	6	0,62
30 x 65	72	38	30	22	17	770	M8	41	5	25	6	0,60
32 x 65	72	38	30	22	17	821	M8	41	5	25	6	0,58
35 x 65	72	38	30	22	17	898	M8	41	5	25	6	0,54
38 x 65	72	38	30	22	17	975	M8	41	5	25	6	0,50
40 x 65	72	38	30	22	17	1026	M8	41	5	25	6	0,47
30 x 80	88	41	33	25	20	1077	M8	41	7	25	6	1,08
32 x 80	88	41	33	25	20	1150	M8	41	7	25	6	1,05
35 x 80	88	41	33	25	20	1257	M8	41	7	25	6	1,01
38 x 80	88	41	33	25	20	1364	M8	41	7	25	6	0,97
40 x 80	88	41	33	25	20	1436	M8	41	7	25	6	0,94
42 x 80	88	41	33	25	20	1509	M8	41	7	25	6	0,91
45 x 80	88	41	33	25	20	1616	M8	41	7	25	6	0,85
48 x 80	88	41	33	25	20	1723	M8	41	7	25	6	0,79
50 x 80	88	41	33	25	20	1796	M8	41	7	25	6	0,75

---

FASTEX IC230  
Compact assembly and operating instructions 3906de  
Edition 05/2022

---

[Flender GmbH](#)  
Alfred-Flender-Straße 77  
46395 Bocholt  
Germany

[flender.com](http://flender.com)

**FLENDER**