



Mill Liner Solutions

Bradken® is a leading mill liner solutions provider, we specialise in delivering innovative wear products tailored to suit all grinding mill applications.

Our Innovation. Your Advantage.



Mill Liner Solutions

Our customers strive for safety, productivity, and efficiency in their mineral processing operations.

That's why we offer a diverse range of mill lining solutions, including steel and rubber-composite liners and process analysis. Each of our customised solutions are designed to meet application requirements across various conditions.

Bradken® leverages over 100 years of expertise in parts design and manufacturing, enhanced by advanced data analytics and simulation technologies, to help mining operations optimize productivity, throughput, mill availability, safety, and energy efficiency.

With the capacity to deliver over 100,000 tonnes of composite and steel mill liners annually across five global sites, we combine scale, innovation, and digital insight to drive performance across the grinding circuit.

Our team is focused on delivering quality mill solutions targeted to improve mill operations through optimised liner designs, manufacturing expertise, and advanced simulations and analysis.

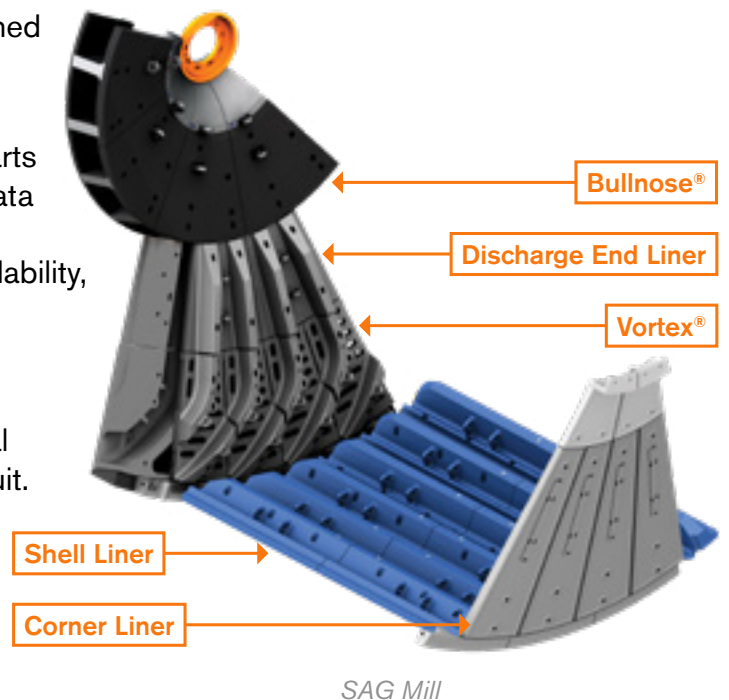

Material Innovation

Bradken utilises a range of proprietary materials such as composite, rubber, steel, alloy, and cast inserts; as they offer different advantages to meet operational requirements and wear mechanisms, such as corrosion, abrasion, and impact. Our local engineering teams determine the most suitable solution and material to achieve mill optimisation and throughput.

Engineered Solutions



Safety

Innovative liner designs that improve product installation and material handling.



Performance

Product, process, and operations.



Availability

Inspection and condition monitoring.

Optimised Liner Design

Mill Liner and Digital Solutions

Every grinding circuit is different. That's why we collaborate closely with mining operations to engineer mill liner solutions aligned to specific ore types, throughput targets, and site conditions.

Our custom liners, combined with advanced digital tools, deliver real-time performance insights, predictive maintenance, and process optimization—helping you extend wear life, reduce downtime, and maximize mill efficiency.

Products and Services

Our optimised designs and range of Liner Solutions offers several advantages including, but not limited to; a reduced number of parts, fewer relines, safer and efficient removal and installation, ultimately resulting in improved safety and a reduction to overall maintenance costs.

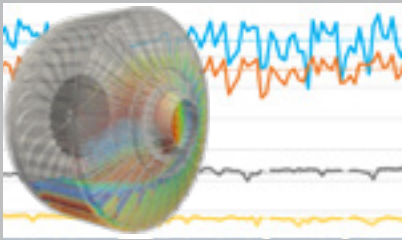

Process Analysis

Our team of experts conducts process analysis to ensure optimal liner design and material selection through various methods; mill liner wear data analysis, trajectory simulation, operational data evaluation, power draw, and charge filling estimation.



Condition Monitoring

Our continuous Condition Monitoring services provide comprehensive on-site inspection and reporting analysis.

Our Condition Monitoring teams utilise advanced techniques to assess the condition of assets and deliver wear monitoring reports that contain performance analysis, comparison data, and recommendations.



Load Monitoring Fastener Plus (LMF+)

Bradken has partnered with Copper State Bolt & Nut™ to deliver monitoring technology solution to support customers, the BoltSense™ Load Monitoring Fastener Plus (LMF+)™ system



Composite Mill Liners

Composite liners use materials such as rubber, steel, and cast inserts; they offer different advantages against a variety of wear mechanisms such as corrosion, abrasion, impact, and weight reduction.

Through multiple simulations, our engineering team can determine the most suitable profile and material to achieve mill optimisation and throughput.



Mill SmartLiner

Bradken's Mills SmartLiner is a simple, wireless measurement system that captures lifter and plate thickness at targeted mill locations. Delivering real-time wear data enables accurate wear rate calculations and wear life to empower mining operations to implement predictive maintenance and optimization strategies that increase mill availability and operational efficiency.



Vertical Grinding Mill

Bradken® customises the design of the Vertical Grinding Mill flights to further increase performance to suit your operating conditions.

We manufacture the liners from superior wear materials to extend your wear life and maximise mill availability.

MillSafe® Solutions Product Range

Bradken® has developed a range of solutions known as MillSafe. These solutions improve both the safety and efficiency of the reline process in SAG/AG/Ball mills.

[Read more online here](#)

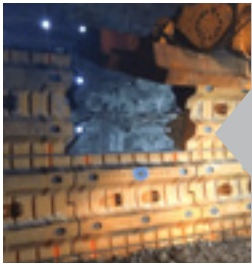

MillSafe Bolting

Bradken's MillSafe Bolting System is a safer and more efficient solution for liner installation and removal for AG/SAG/Ball mills, removing people from hazardous zones within your grinding mill. Install your liners by bolting them from outside your grinding mill.



MillSafe Backing

Bradken's MillSafe Backing is a replacement for grinding mill rubber sheeting. Designed to remove costly maintenance delays to repair damaged rubber sheeting on grinding mills. Providing a safer relining environment.

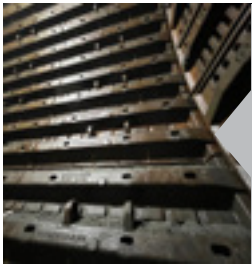

MillSafe Combined Corner Liners

Bradken's innovative Combined Corner Liner design improves reline safety, significantly reduces reline times and part inventory.

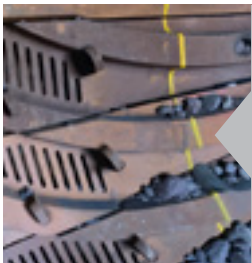

MillSafe Liner Location Stripes

Bradken's MillSafe Liner Location Stripes provide visual guidance to deliver a safer and more efficient liner install.

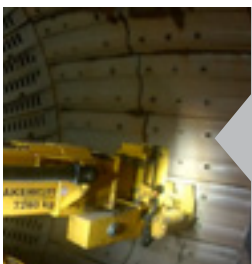

MillSafe Worn Liner Removal With RME INSIDEOUT™ Technology

Bradken's MillSafe removal system removes worn liners from the mill shell wall directly to provide a safer and more efficient liner removal process.

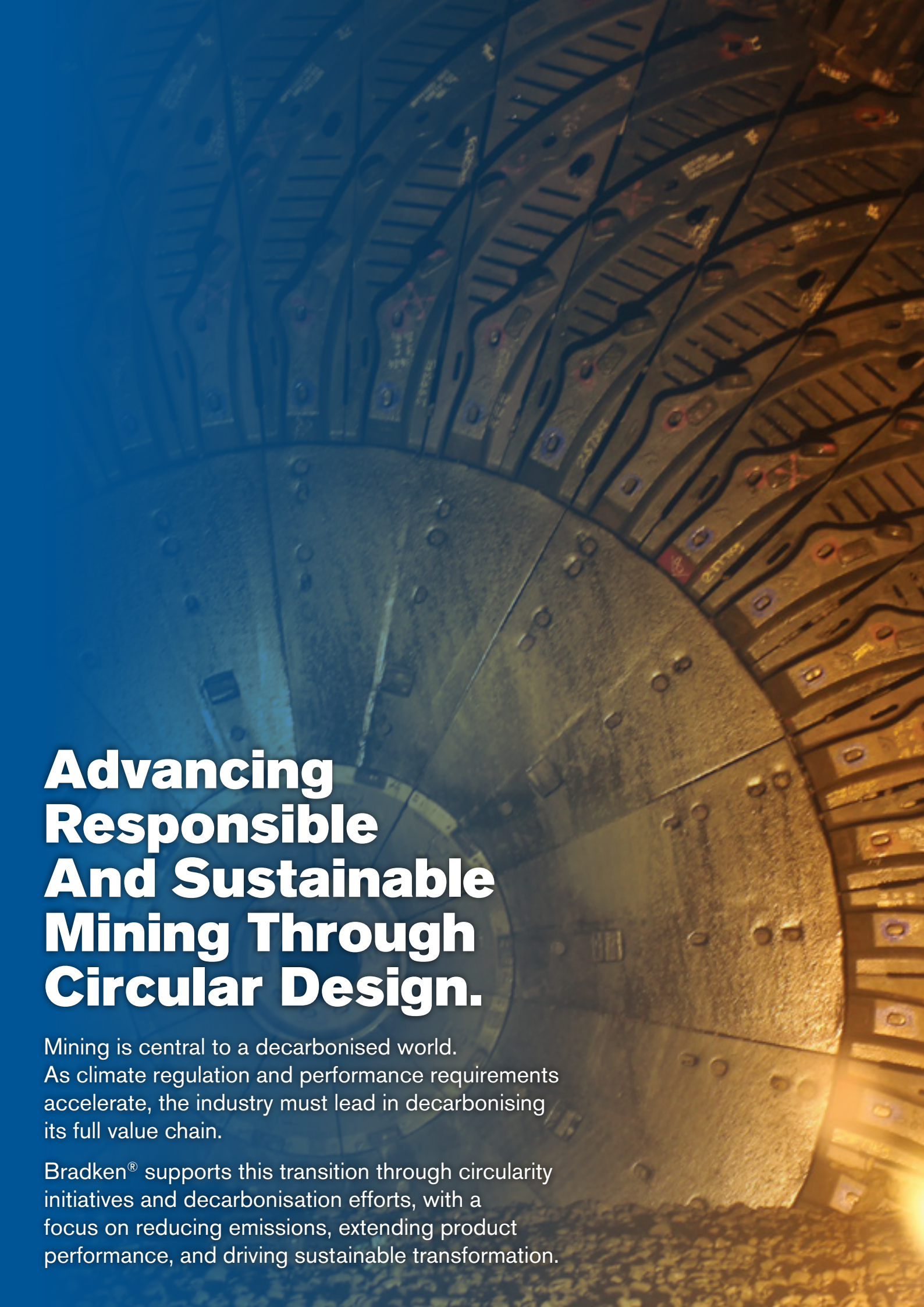

Advancing Responsible And Sustainable Mining Through Circular Design.

Mining is central to a decarbonised world. As climate regulation and performance requirements accelerate, the industry must lead in decarbonising its full value chain.

Bradken® supports this transition through circularity initiatives and decarbonisation efforts, with a focus on reducing emissions, extending product performance, and driving sustainable transformation.



**Contact Bradken®
globally to find a solution
for your business.**



**Ability to deliver more than 100,000 tonnes of composite
and steel mill liners annually, across five sites globally.**

Our Innovation. Your Advantage.

Bradken Mill Solutions Overview Flyer-REV4-April 2026-English. BRADKEN© 2026 All company names, logos, and identifying marks used throughout this publication are the property of their respective trademark owners, they are used for descriptive purposes only.

