

SLANT FACE PLENUM DIFFUSER

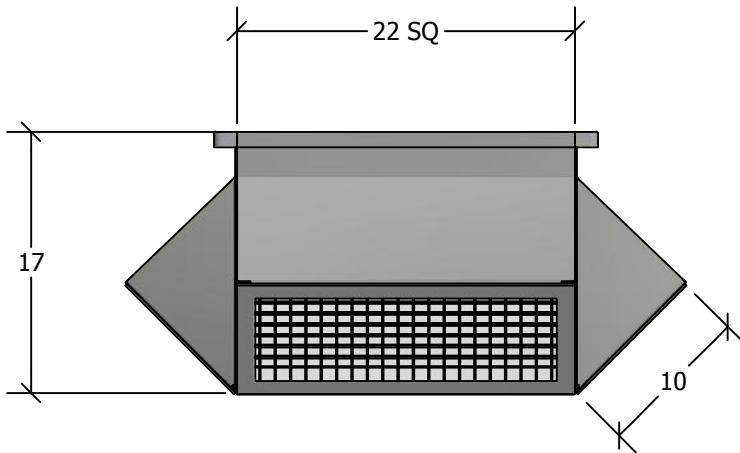

STANDARD FEATURES

1. G-90 Galvanized Steel Construction.
2. Turning Vanes in Each Quadrant.
3. 1" 1-1/2 lb. Duct Liner.
4. Vertical and Horizontal Adjustable Deflection Grilles.
5. Fully Assembled
6. TDC Duct Connections Provided.
7. Engineered Curb and Duct Packages Available.

NOM CFM 3,000	MODEL NO SFPD 2008-7.5	WEIGHT 43 LBS
0° DEFLECTION		
THROW 49'	P.D. .11	NC 26
22 1/2° DEFLECTION		
THROW 39'	P.D. .12	NC 27
45° DEFLECTION		
THROW 22'	P.D. .17	NC 33

QTY TAG

JOB NAME

CURBS PLUS, INC.
www.curbs-plus.com