



# Installation and Operation Instructions

## CODE 3 CONNECT

**IMPORTANT!** Read all instructions before installing and using. Installer: This manual must be delivered to the end user.



**WARNING!**

Failure to install or use this product according to manufacturer's recommendations may result in property damage, serious injury, and/or death to those you are seeking to protect!



**Do not install and/or operate this safety product unless you have read and understood the safety information contained in this manual.**

1. Proper installation combined with operator training in the use, care, and maintenance of emergency warning devices are essential to ensure the safety of emergency personnel and the public.
2. Emergency warning devices often require high electrical voltages and/or currents. Exercise caution when working with live electrical connections.
3. This product must be properly grounded. Inadequate grounding and/or shorting of electrical connections can cause high current arcing, which can cause personal injury and/or severe vehicle damage, including fire.
4. Proper placement and installation is vital to the performance of this warning device. Install this product so that output performance of the system is maximized and the controls are placed within convenient reach of the operator so that they can operate the system without losing eye contact with the roadway.
5. Do not install this product or route any wires in the deployment area of an air bag. Equipment mounted or located in an air bag deployment area may reduce the effectiveness of the air bag or become a projectile that could cause serious personal injury or death. Refer to the vehicle owner's manual for the air bag deployment area. It is the responsibility of the user/operator to determine a suitable mounting location ensuring the safety of all passengers inside the vehicle particularly avoiding areas of potential head impact.
6. It is the responsibility of the vehicle operator to ensure daily that all features of this product work correctly. In use, the vehicle operator should ensure the projection of the warning signal is not blocked by vehicle components (i.e., open trunks or compartment doors), people, vehicles or other obstructions.
7. The use of this or any other warning device does not ensure all drivers can or will observe or react to an emergency warning signal. Never take the right-of-way for granted. It is the vehicle operator's responsibility to be sure they can proceed safely before entering an intersection, drive against traffic, respond at a high rate of speed, or walk on or around traffic lanes.
8. This equipment is intended for use by authorized personnel only. The user is responsible for understanding and obeying all laws regarding emergency warning devices. Therefore, the user should check all applicable city, state, and federal laws and regulations. The manufacturer assumes no liability for any loss resulting from the use of this warning device.

## Specifications

Input Voltage: 12 VDC

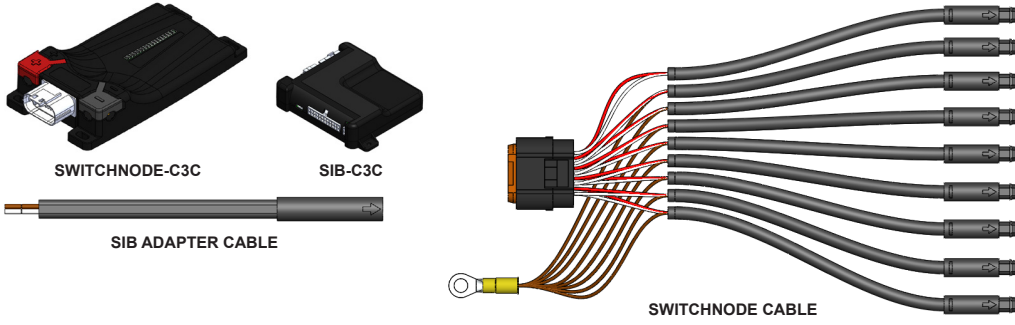
Input Current: Varies based on hardware selected

Temp Range: -40°C to 65°C

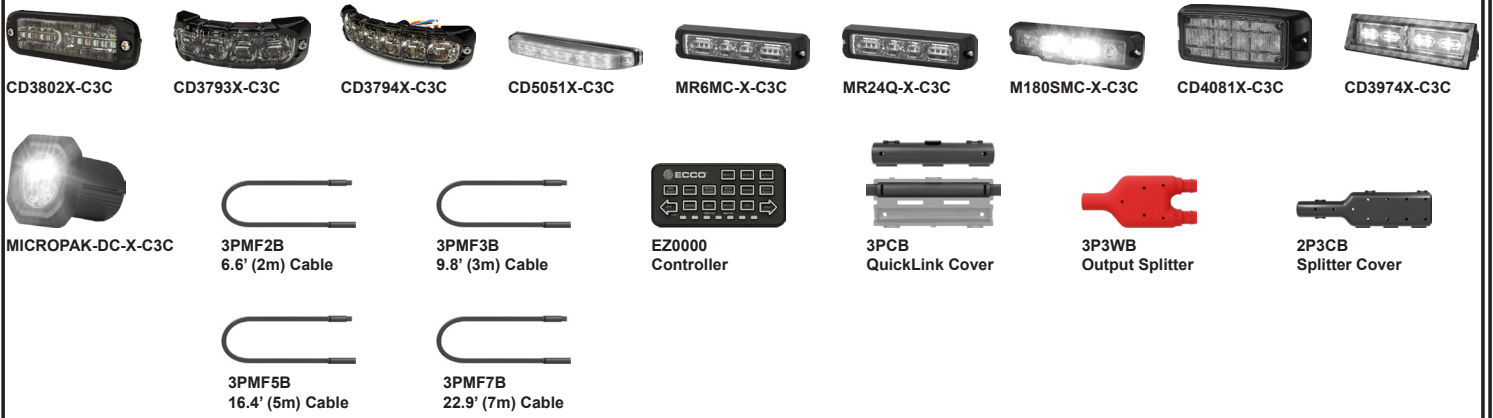
-40°F to 149°F

# Kit Contents

## Core Products



## Optional Products



## Installation and Mounting

- Mount and apply power/ground to the Switchnode and Z3 or SIB in the vehicle as instructed in the individual product install manuals.
- Connect the Z3 to Switchnode using the 15' 2-wire CAN harness (PN 690-1111-02). This cable can be cut to length.
  - Insert the female connector into male connector "0" on the Switchnode harness (PN 670-0603-00). See Figure 1.
  - On the other end of the cable, the brown wire connects into the "B" side of the CAN port. The white wire connects into the "Y" side of the CAN port. See Figure 2.
- Insert the Switchnode Harness (PN 670-0603-00) into the Switchnode as shown in Figure 1.
  - Attach the ring terminal from the brown grounding wires to the ground lug of the Switchnode (torque to 20 in-lb).
- Attach the jumper cables (female connector side) to the Switchnode harness and route to where the lightheads will be mounted on the vehicle. Use arrow indicators on connectors for proper alignment. Add optional covers. See Figure 4.
- Attach lightheads to the jumper cables. Use arrow indicators on connectors for proper alignment. Add optional covers. See Figure 4. Mount the lightheads per the install instructions included with each product. Some lightheads may include two connectors. Each connector will connect back to the Switchnode outputs.

## Splitters and Covers

Covers and Splitters are available for use with the system. The covers provide up to 55lbs of breaking force between connections. The splitters allow multiple lightheads to be powered from one output up to 5A. See Figures 3 and 4.

## Jumper Cables

Cables are water resistant and can be installed in dry or damp locations. The cables can be daisy chained together to create longer lengths. Note the maximum length of cable based on the load:

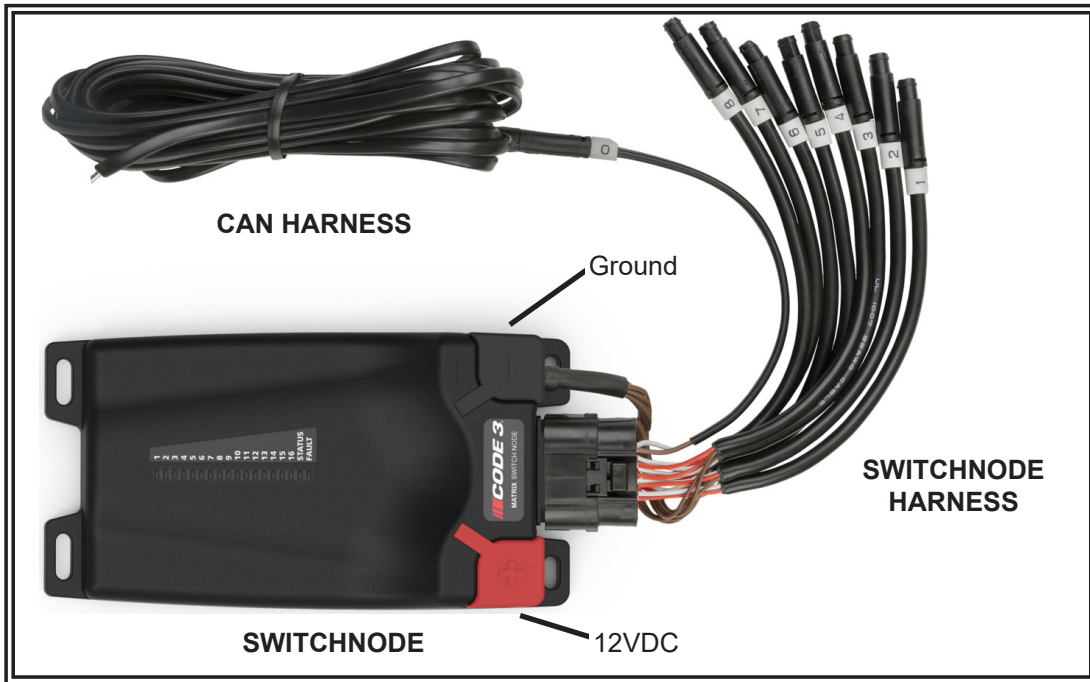
Max Length (5% Voltage Drop)		
Amp @ 13.8V	0.5	85.5 feet
	1.0	42.7 feet
	1.5	28.5 feet
	2.0	21.4 feet
	2.5	16.9 feet
	3.0	14.2 feet
	3.5	12.2 feet
	4.0	10.6 feet
	4.5	9.5 feet
	5.0	8.53 feet

## Programming

Use Matrix to program the lightheads based on your requirements. Each connector corresponds to Switchnode output wires in the software. See Figure 5.

Connector	Switchnode Output Wire
1	Blue/White Wire
	Blue/Black Wire
2	White Wire
	White/Black Wire
3	Red/White Wire
	Red/Black Wire
4	Orange/White Wire
	Orange Wire
5	Yellow/White Wire

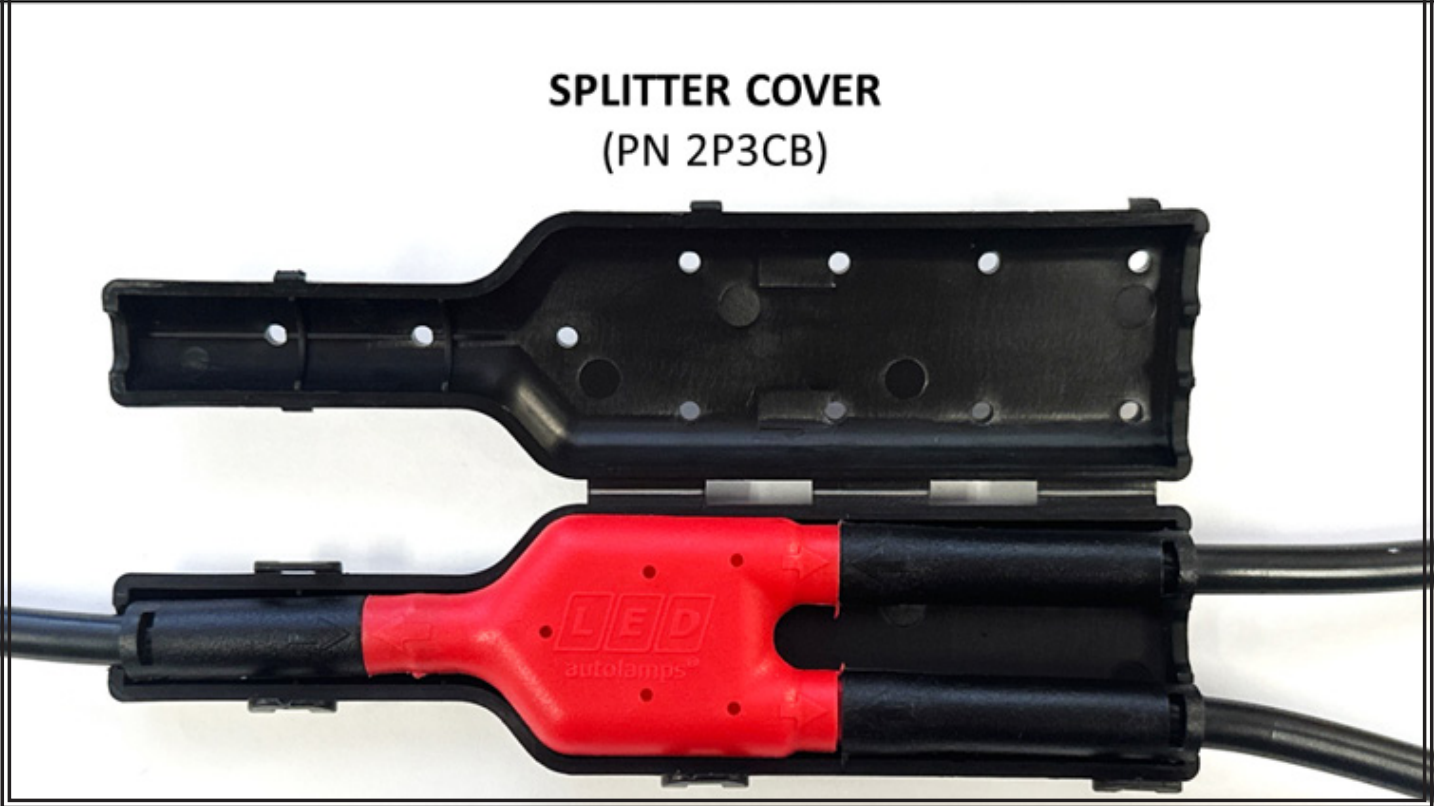
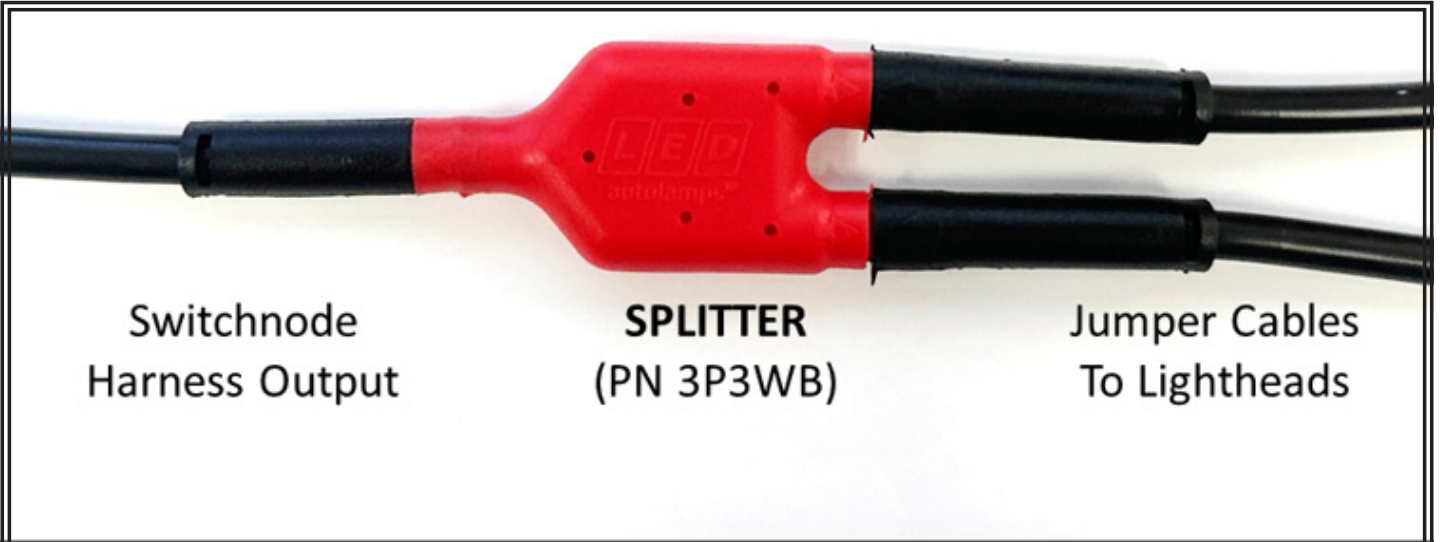
6	Black/White Wire
	Black/Yellow Wire
7	Green Wire
	Green/Black Wire
8	Purple/White Wire
	Purple Wire



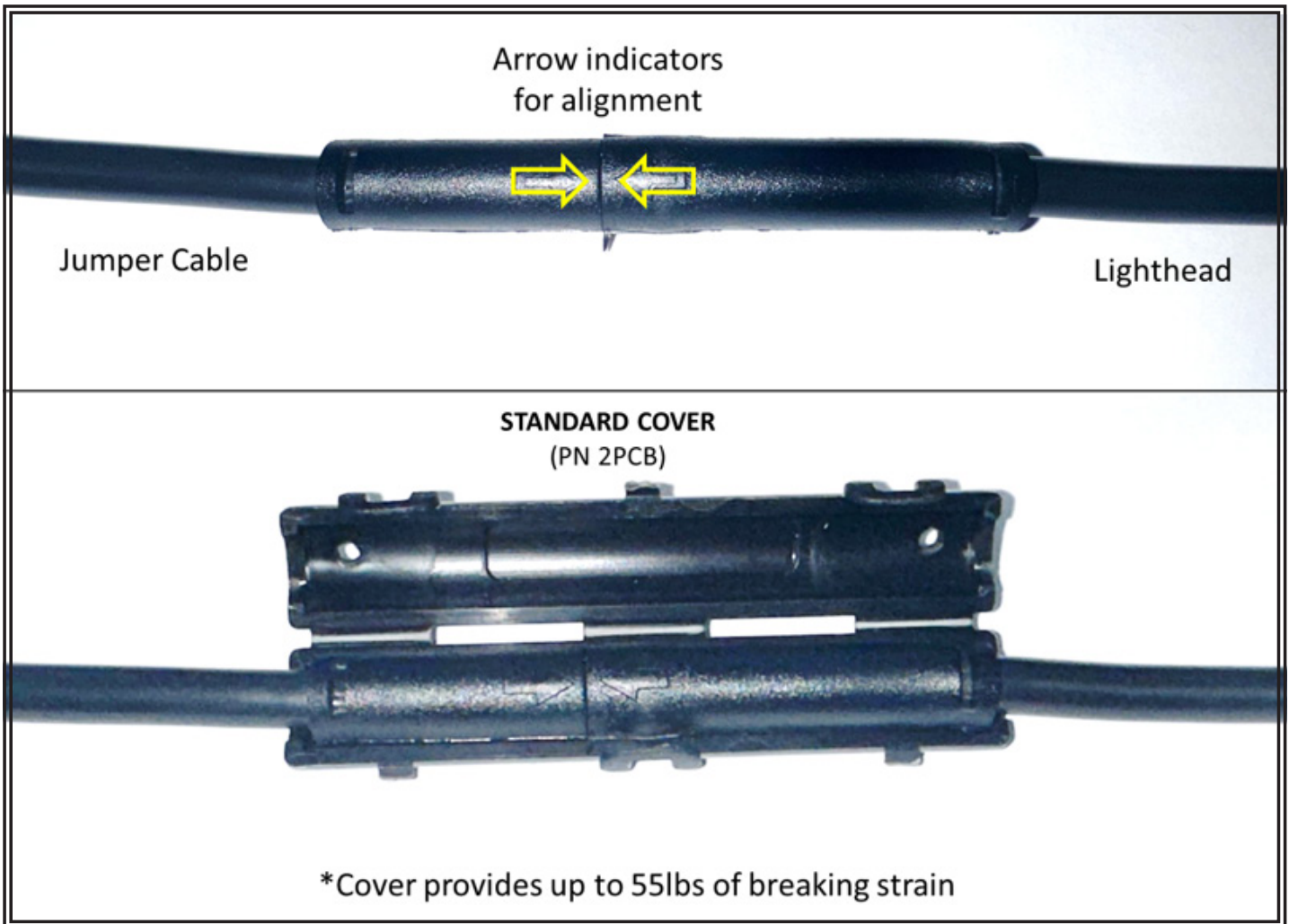
**Figure 1**  
Switchnode - C3C



**Figure 2**  
Connecting 690-1111-02 to a SIB or Z3

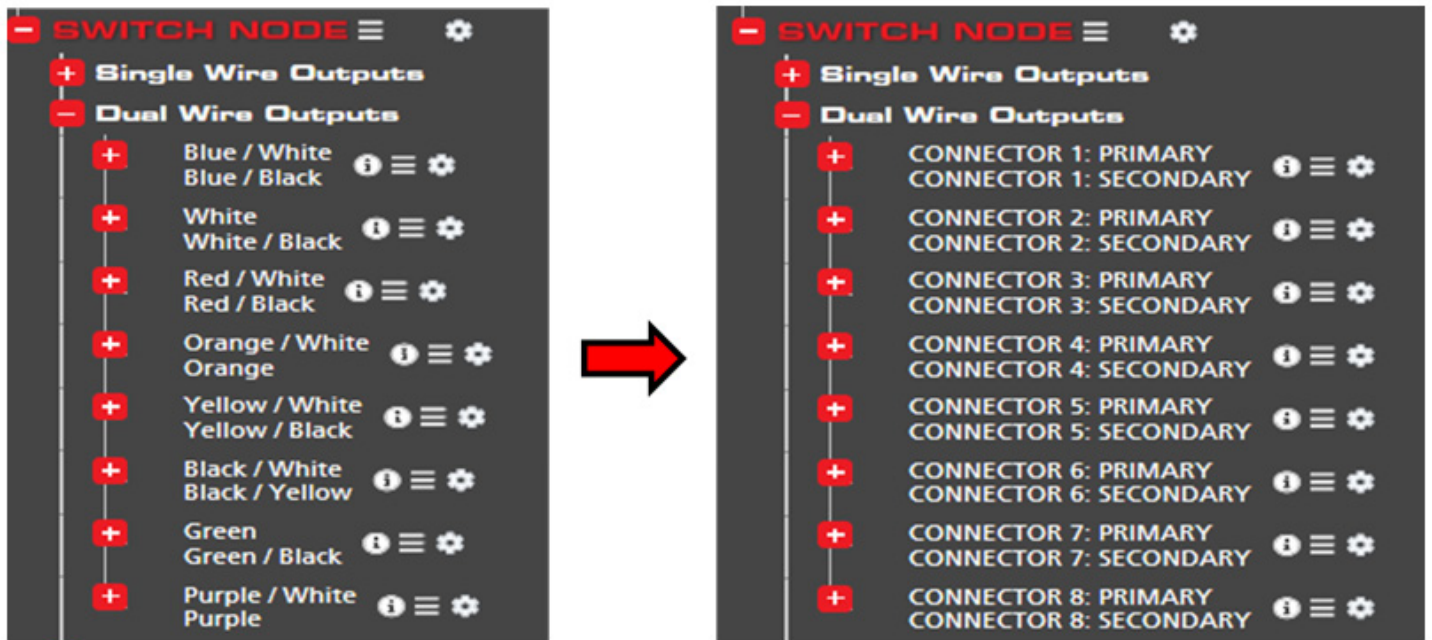


**Figure 3**  
Splitter with Cover



**Figure 4**

**QuickLink Connectors and Cover**



**Figure 5**

**Matrix Programming**

## Warranty

### Manufacturer Limited Warranty and Limitation of Liability:

Manufacturer warrants that on the date of purchase, this product will conform to Manufacturer's specifications for this product (which are available from the Manufacturer upon request). This Limited Warranty extends for sixty (60) months from the date of purchase.

DAMAGE TO PARTS OR PRODUCTS RESULTING FROM TAMPERING, ACCIDENT, ABUSE, MISUSE, NEGLIGENCE, UNAPPROVED MODIFICATIONS, FIRE OR OTHER HAZARD; IMPROPER INSTALLATION OR OPERATION; OR NOT BEING MAINTAINED IN ACCORDANCE WITH THE MAINTENANCE PROCEDURES SET FORTH IN MANUFACTURER'S INSTALLATION AND OPERATING INSTRUCTIONS VOIDS THIS LIMITED WARRANTY.

### Exclusion of Other Warranties:

MANUFACTURER MAKES NO OTHER WARRANTIES, EXPRESSED OR IMPLIED. THE IMPLIED WARRANTIES FOR MERCHANTABILITY, QUALITY OR FITNESS FOR A PARTICULAR PURPOSE, OR ARISING FROM A COURSE OF DEALING, USAGE OR TRADE PRACTICE ARE HEREBY EXCLUDED AND SHALL NOT APPLY TO THE PRODUCT AND ARE HEREBY DISCLAIMED, EXCEPT TO THE EXTENT PROHIBITED BY APPLICABLE LAW. ORAL STATEMENTS OR REPRESENTATIONS ABOUT THE PRODUCT DO NOT CONSTITUTE WARRANTIES.

### Remedies and Limitation of Liability:

MANUFACTURER'S SOLE LIABILITY AND BUYER'S EXCLUSIVE REMEDY IN CONTRACT, TORT (INCLUDING NEGLIGENCE), OR UNDER ANY OTHER THEORY AGAINST MANUFACTURER REGARDING THE PRODUCT AND ITS USE SHALL BE, AT MANUFACTURER'S DISCRETION, THE REPLACEMENT OR REPAIR OF THE PRODUCT, OR THE REFUND OF THE PURCHASE PRICE PAID BY BUYER FOR NON-CONFORMING PRODUCT. IN NO EVENT SHALL MANUFACTURER'S LIABILITY ARISING OUT OF THIS LIMITED WARRANTY OR ANY OTHER CLAIM RELATED TO THE MANUFACTURER'S PRODUCTS EXCEED THE AMOUNT PAID FOR THE PRODUCT BY BUYER AT THE TIME OF THE ORIGINAL PURCHASE. IN NO EVENT SHALL MANUFACTURER BE LIABLE FOR LOST PROFITS, THE COST OF SUBSTITUTE EQUIPMENT OR LABOR, PROPERTY DAMAGE, OR OTHER SPECIAL, CONSEQUENTIAL, OR INCIDENTAL DAMAGES BASED UPON ANY CLAIM FOR BREACH OF CONTRACT, IMPROPER INSTALLATION, NEGLIGENCE, OR OTHER CLAIM, EVEN IF MANUFACTURER OR A MANUFACTURER'S REPRESENTATIVE HAS BEEN ADVISED OF THE POSSIBILITY OF SUCH DAMAGES. MANUFACTURER SHALL HAVE NO FURTHER OBLIGATION OR LIABILITY WITH RESPECT TO THE PRODUCT OR ITS SALE, OPERATION AND USE, AND MANUFACTURER NEITHER ASSUMES NOR AUTHORIZES THE ASSUMPTION OF ANY OTHER OBLIGATION OR LIABILITY IN CONNECTION WITH SUCH PRODUCT.

This Limited Warranty defines specific legal rights. You may have other legal rights which vary from jurisdiction to jurisdiction. Some jurisdictions do not allow the exclusion or limitation of incidental or consequential damages.



10986 North Warson Road, St. Louis, MO 63114 USA  
**Technical Service** USA (314) 996-2800  
c3\_tech\_support@code3esg.com  
**CODE3ESG.com**

An **ECCO SAFETY GROUP™** Brand  
**ECCOSAFETYGROUP.com**