



# ISKU

## STANDARD TABLE TOPS

# TABLE TOP STANDARD

Tops are 26 mm thick furniture board or MDF covers.

Asymmetrical tops are shown left-handed but are also available right-handed.

Beech veneered lids can be stained with ISKU standard stain colors.

Veneered EL and P tops are beveled MDF covers. Lam 215 (white) and lam 230 (light gray) EL and P covers are ABS edged.

Top collection is available laser-edged.

The entire collection can be implemented as an antimicrobial.

## Edge options

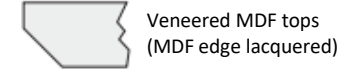

## Edge options

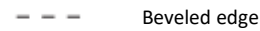
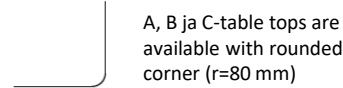
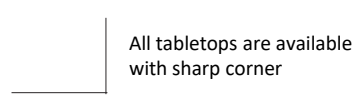

## Cast edge (Teamix) available for the following

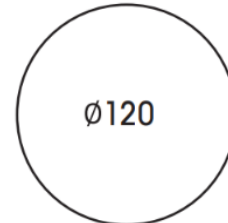
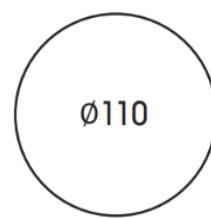
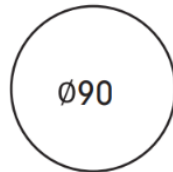
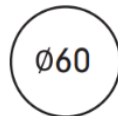
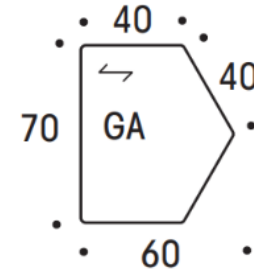
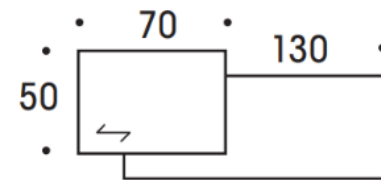
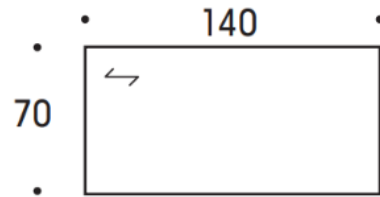

# Universal and work desks

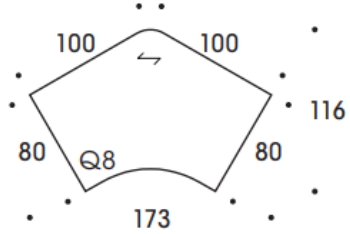
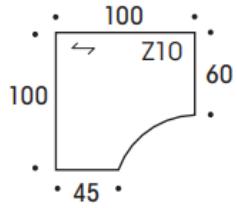
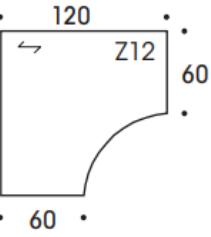
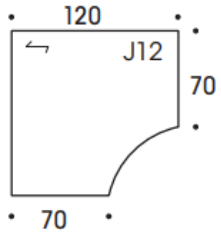
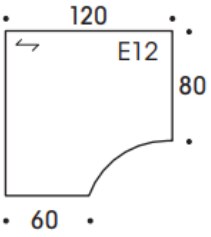
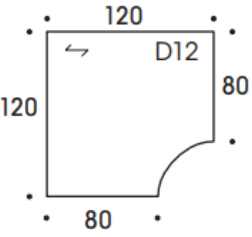
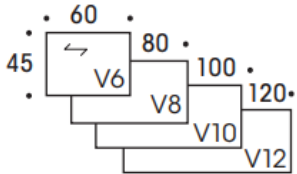
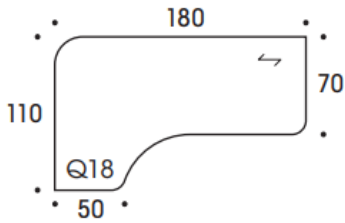
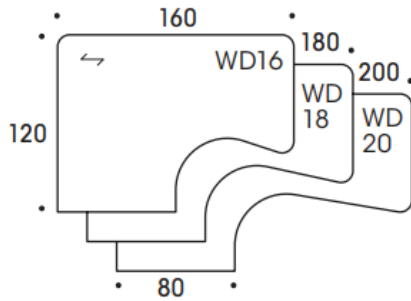
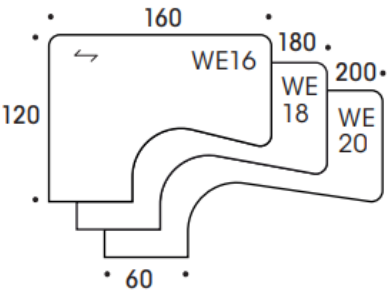
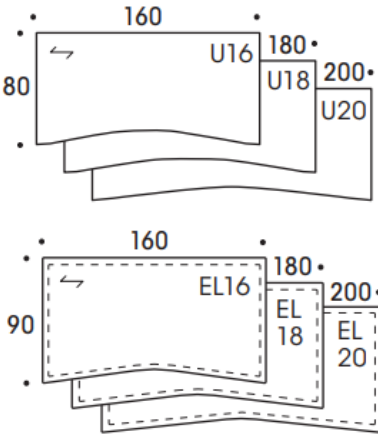
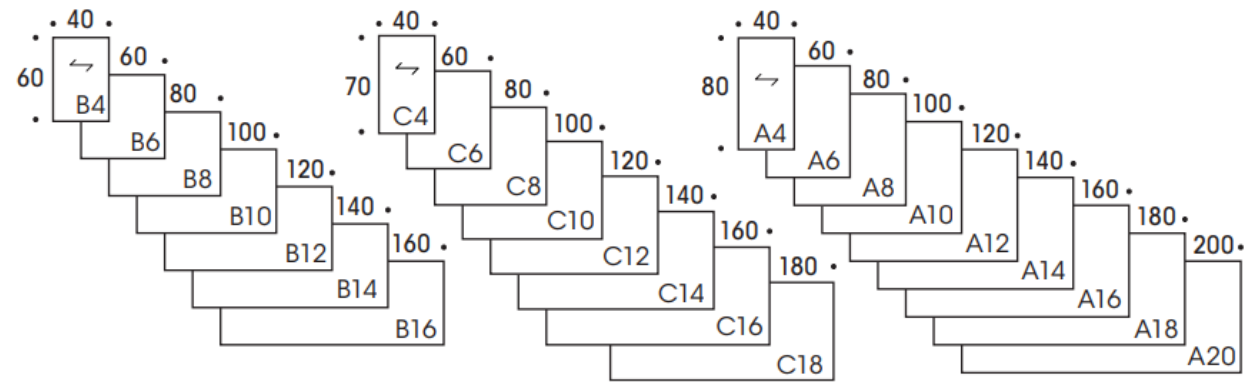

## Conference tables

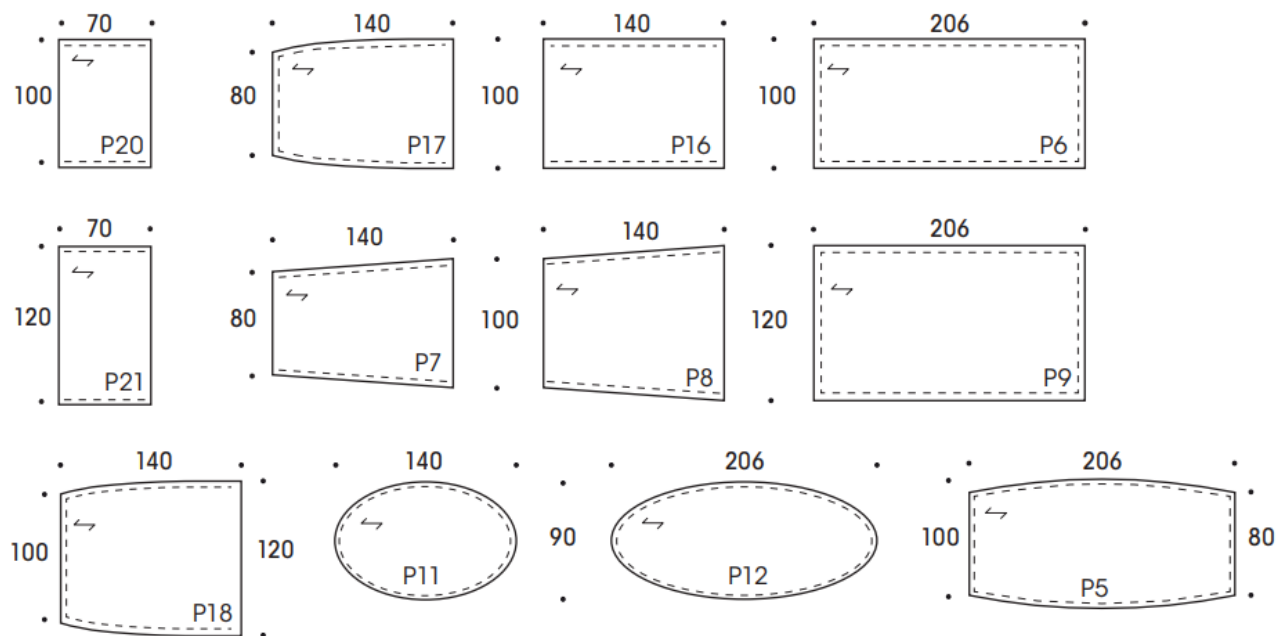

## Groupworks tables

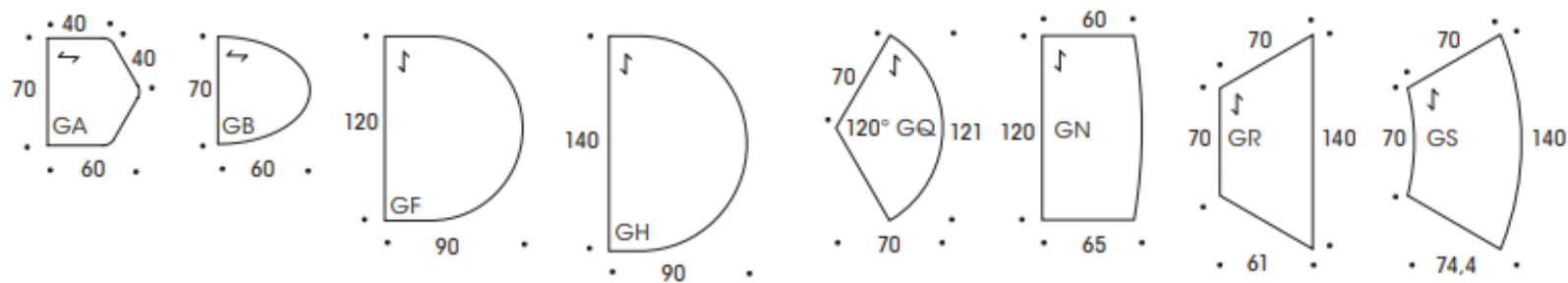

Round and oval tables

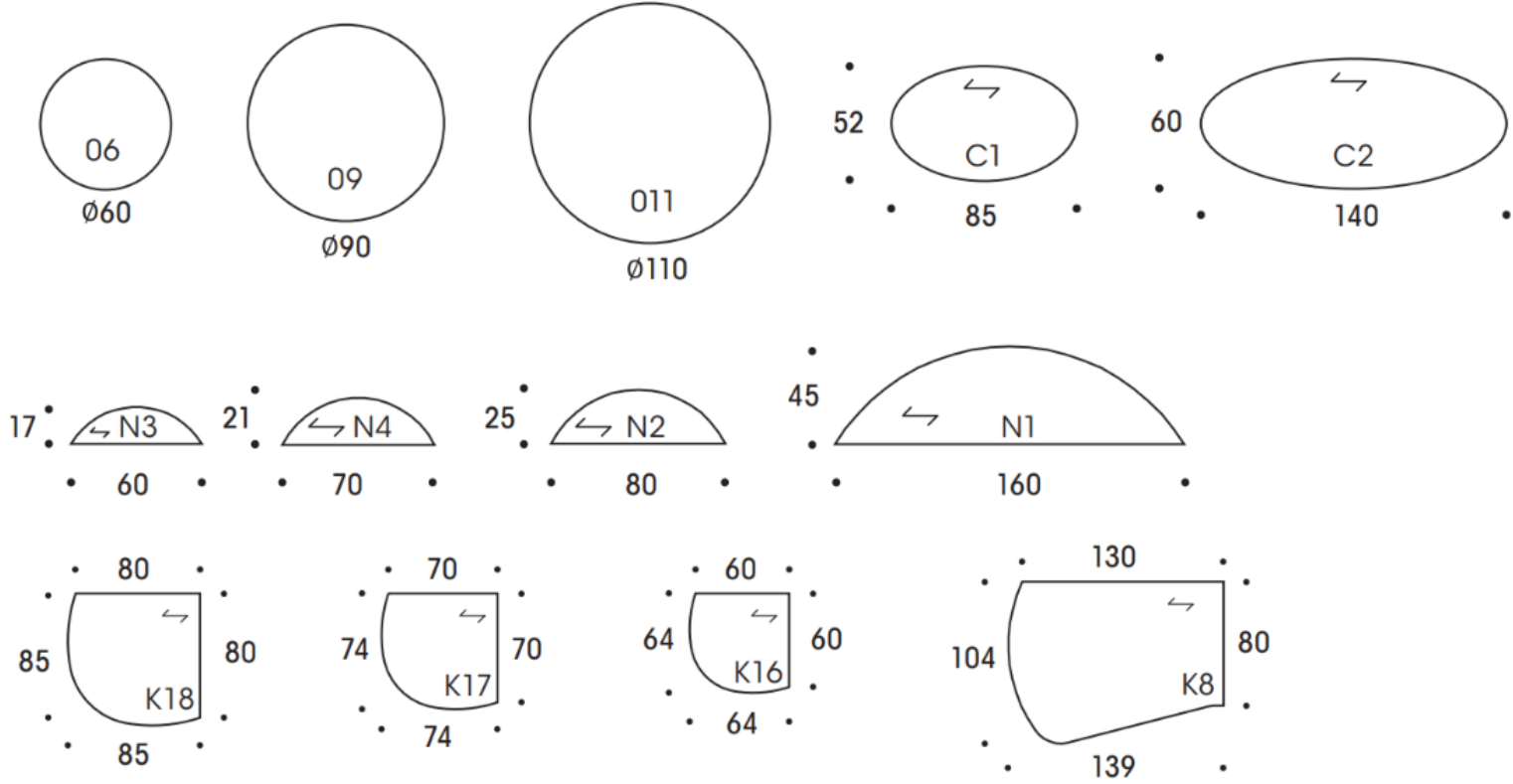

Nook, Kivikko and Solu tables

