

FLOYD

**Display
Shelf**

Components

4x

Wood Supports



2x

Fixed Shelves

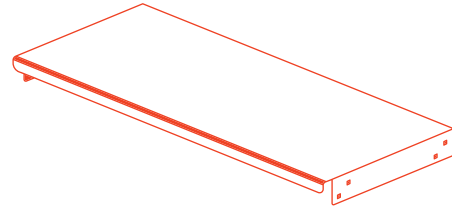

3x

Shelves

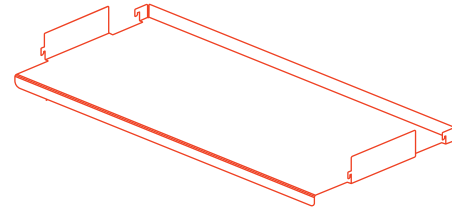

Components cont.

1x

Display Shelf

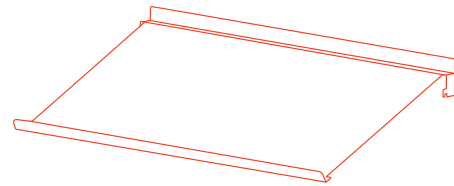

1x

Hex Tool



Components cont.

16x

Bolts



16x

Nuts



8x

Felt Pads
(for bottom of wood supports)



Wall Anchor Kit Components

1x Wall Anchor Bracket

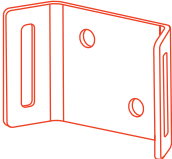

2x Screws



2x Drywall Anchors



2x Velcro Tape Straps
(choose black or white)



Additional items you may need for installing the Wall Anchor:

1x **Phillips Head Screwdriver**



1x **Hammer**

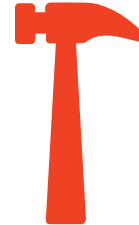

1x **Drill w/ 1/4" Drill Bit**

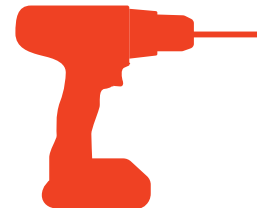

Assembly Tips:

- **Keep all packaging until assembly is complete to ensure you have all parts needed for assembly.**
- **Assemble on a soft surface, like a rug or cardboard to protect the finish.**
- **Two people are recommended for assembly.**
- **If your floor is uneven, you can use the provided felt pads to level your Shelving System. The felt pads can be stacked on top of each other to add more height on one or more Wood Supports as needed.**
- **WARNING:** Serious or fatal crushing injuries can occur from furniture tip-over. The Wall Anchor Kit should be installed to help prevent tip-over for the Tall Shelf, Wardrobe, and Display Shelf.

1

Position the first fixed shelf

Place one fixed shelf (a) with its back edge on the floor and have a friend hold in place. Place two wood supports on either side of the fixed loop with the metal part facing down. The bottom end of the wood supports have a notch cut in the wood. Align the holes at the bottom end of the wood support with the square holes on the fixed shelves.

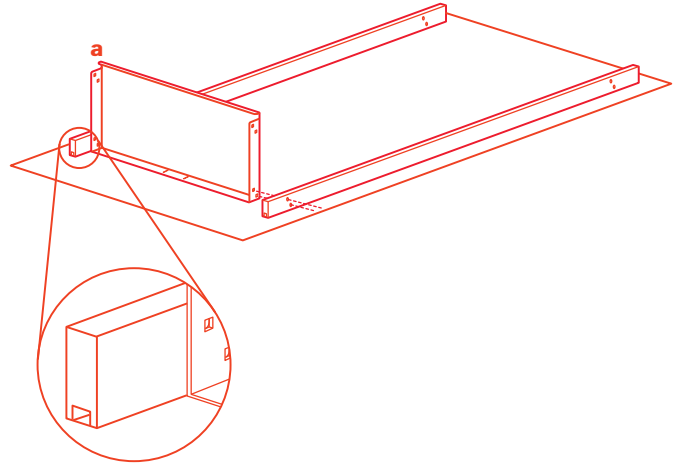
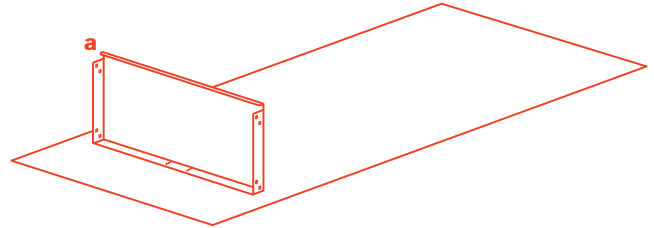

2

a

Begin to attach the first fixed shelf

Insert two bolts through the square holes in the fixed shelf (a) and until they are fully inserted.

Next, insert the nuts (b) through the holes in the wood and begin to tighten them to the bolts by hand.

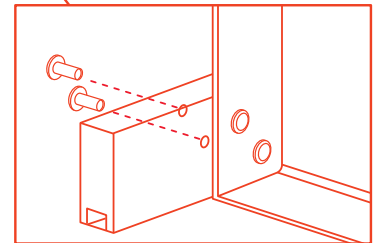
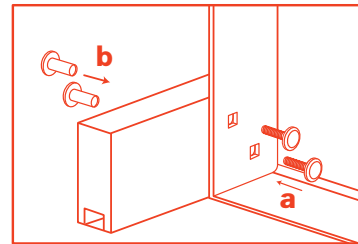

2

b

Tighten fasteners to secure the fixed shelf to wood supports

Finish tightening the nuts with the hex tool. The bolt should stay in place, but may need to be pressed to hold in place when tightening the nut.

Repeat steps 2a-2b to tighten the fasteners on the other side before proceeding.

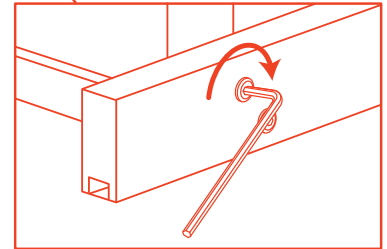
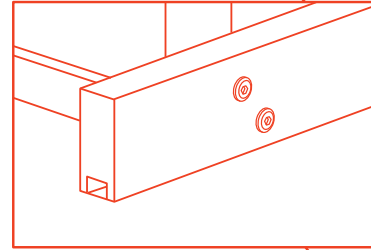

3

Attach second fixed shelf at the top

Place the second fixed shelf (b) at the top of the wood supports and repeat steps 2a-2b to attach it to the two wood supports.

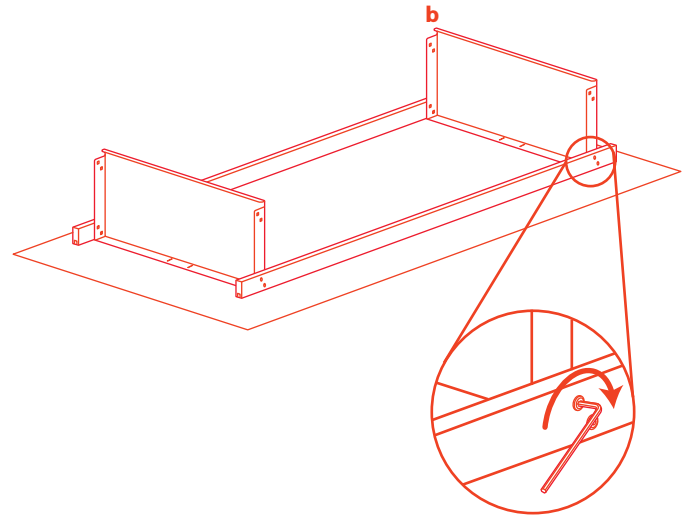

4

Attach the front wood supports

Take the two remaining wood supports and attach them to the fixed shelf as shown in steps 2a-2b. Have a friend hold the wood supports in place while you attach them to the fixed shelves.

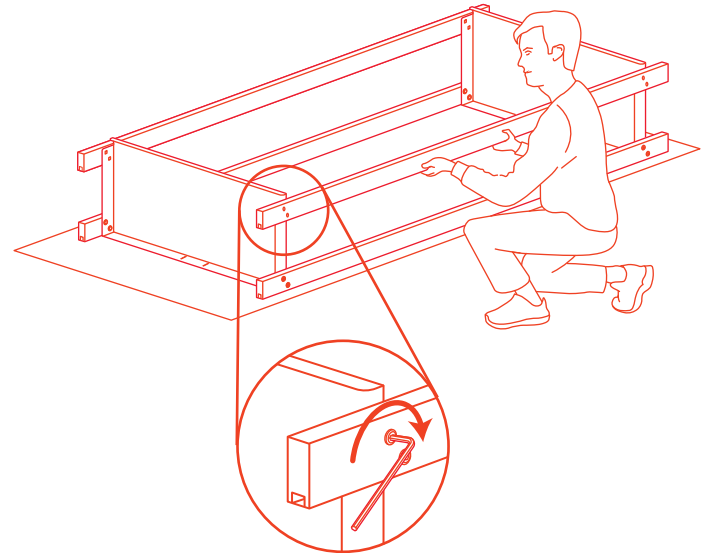

5

Stand the shelf upright

Stand the shelf upright with the help of a friend.

Note: After standing up the shelf, double check each connection to make sure fasteners are fully tightened and secure.

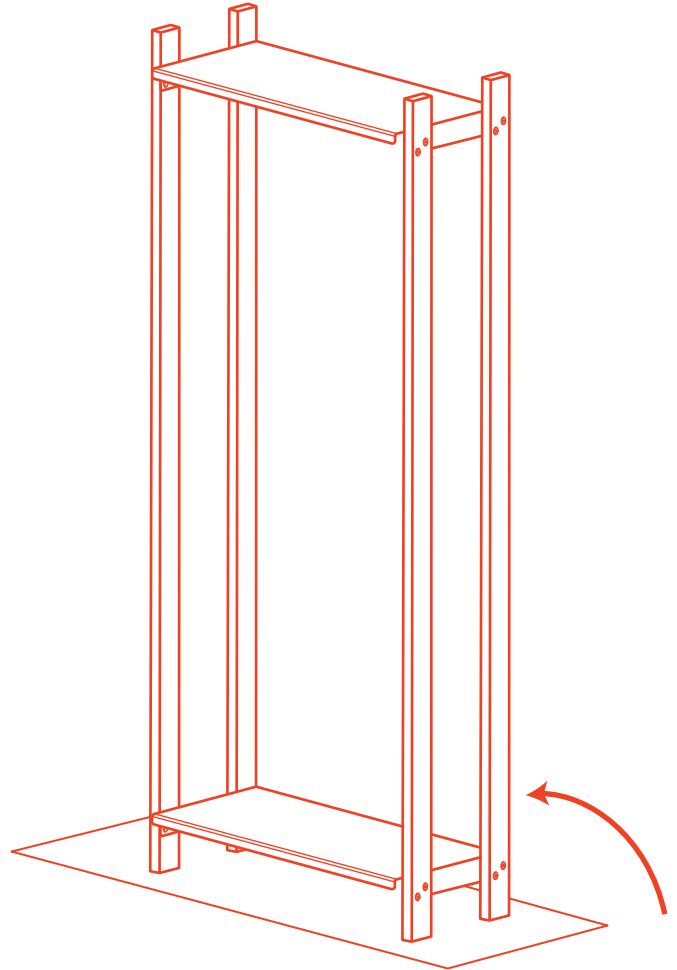

6

Add the shelves

To attach the shelves, insert each shelf from the back at a 45 degree angle. Rotate the shelf parallel to the floor so that the tall side flanges of the shelf are in between the wood supports. Insert the hooks on each shelf into the slots in the metal tracks on the back side of each wood support.

Note: Make sure all four hooks on each shelf are inserted into the slots in the metal tracks on the wood supports.

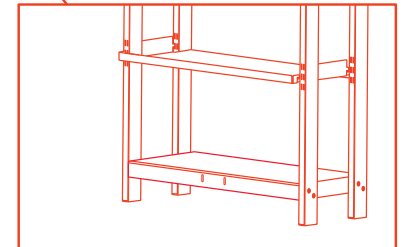
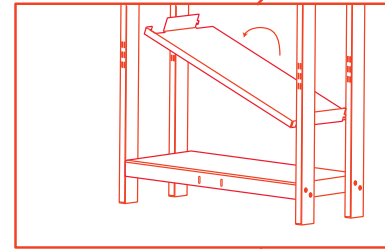
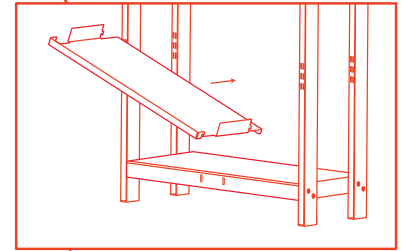
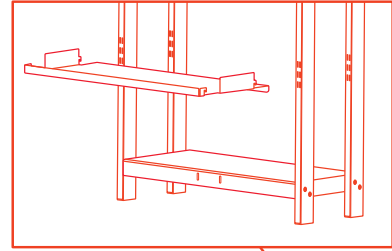

7

a

Attach the Display Shelf

Rotate the display shelf 45 degrees, then insert from behind. Rotate so it's parallel to the floor and insert the back hooks into the slots in the wood supports.

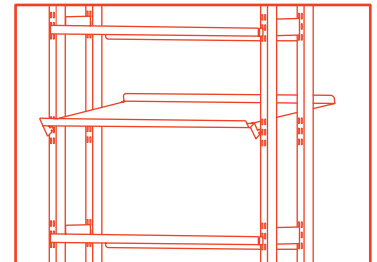
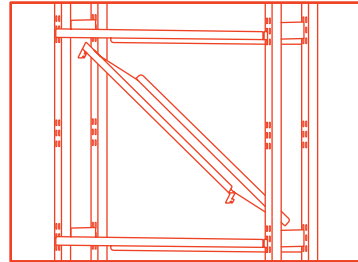
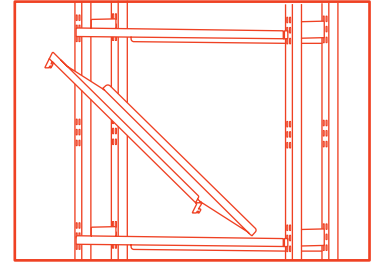
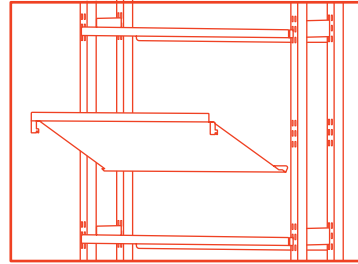

7

b

Attach the Display Shelf

Tilt the shelf forward so that the hooks go into the slots and the edges on the front of the shelf are resting on the front of the wood supports.

Note: The Display shelf can be attached with any of the slots where a standard shelf can be attached.

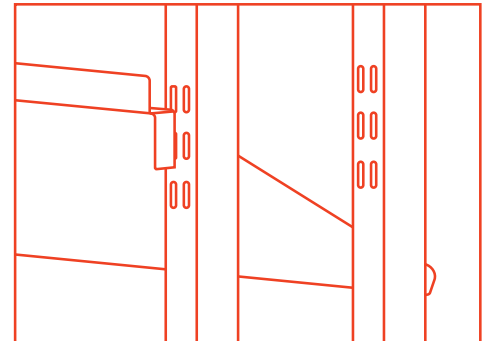
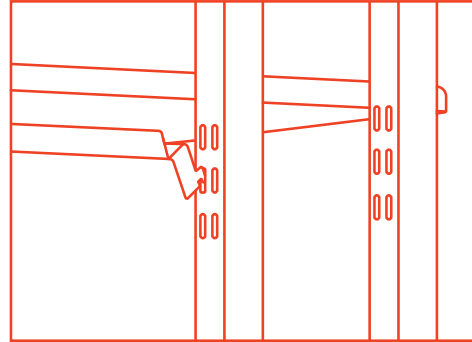

8

Adjust shelves (optional)

The shelf spacing is adjustable. With each shelf attached to the middle slot, the shelves will be evenly spaced. To increase or decrease shelf spacing, insert the hooks on the shelves into the slots above or below the middle slots.

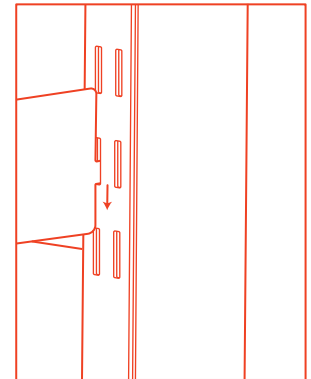
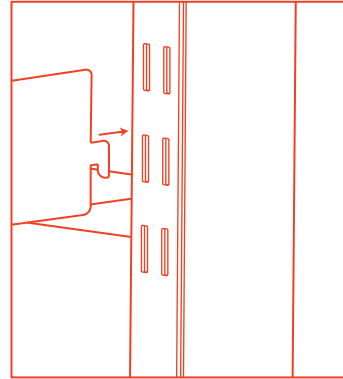

9

Install the wall anchor

After adding the shelves & adjusting as desired, place the fully assembled shelf unit against the wall.

Continue to the next page to install the Wall Anchor and attach your Shelving System to the wall. The Wall Anchor Kit should be installed to help prevent furniture tip-over.

@floyddetroit
#thefloydshelf

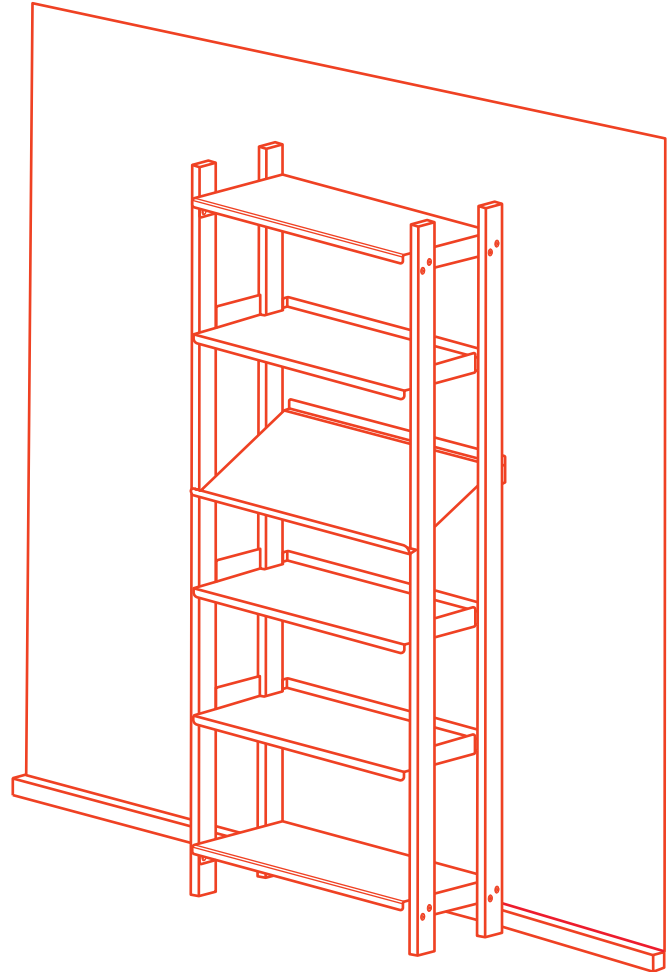

Install the wall anchor

WARNING

Serious or fatal crushing injuries can occur from furniture tip-over. To help prevent tip-over, the Wall Anchor Kit should be installed per these instructions.

To further reduce the risk of furniture tip-overs:

- Place heaviest items in the lowest shelves.
- Do not set TVs or other heavy objects on the top of the Shelving System.
- Never allow children to climb or hang on shelves.

Note that the use of the Wall Anchor Kit may only reduce, but not eliminate, the risk of tip-over.

For safe mounting, it is essential to use wall anchors appropriate to your wall type (i.e. dry-wall, plaster, brick, concrete, etc). The following steps and provided hardware are for drywall or wood stud mounting. Mount to wood studs whenever possible. For attaching to other wall types, please consult your local hardware store for fastener advice.

1

Mark the wall

Mark the slots on the back of the fixed shelf on the wall with a pencil, then move the shelf unit away from wall.

Align the wall anchor bracket between the slot marks, then mark the holes in the wall anchor bracket with a pencil.

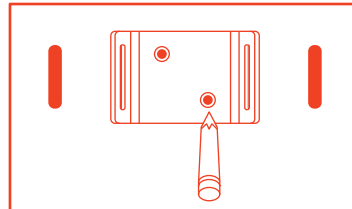
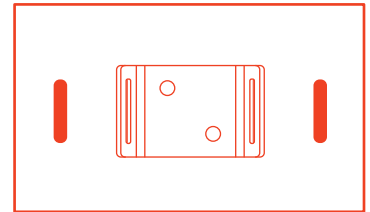
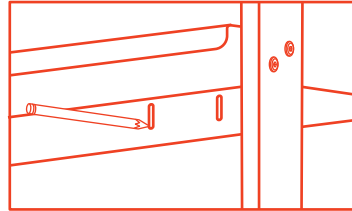

2

Insert drywall anchors (if needed)

Set the wall anchor bracket aside and drill two holes into the wall with a 1/4" drill bit (x2).

Push the drywall anchors into wall by hand (x2). If mounting to a stud, do not use the drywall anchors.

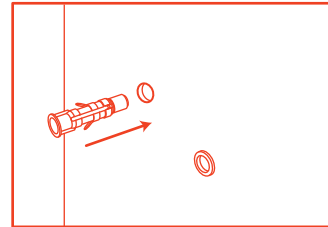
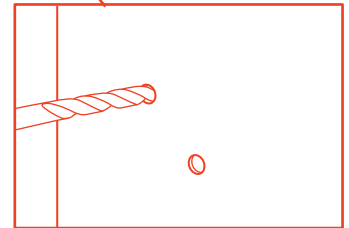
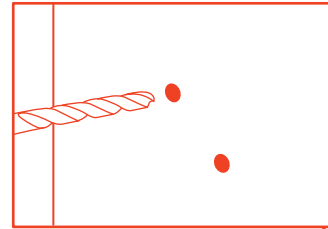

3

Attach the wall anchor bracket

Align the wall anchor bracket with the two holes and screw it to the wall using the provided screws and a phillips head screwdriver (x2). For stud mounting, use a power drill with a phillips head bit for the screws.

Feed the Velcro Tape strap through the two slots in the wall anchor.

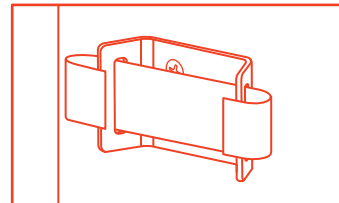
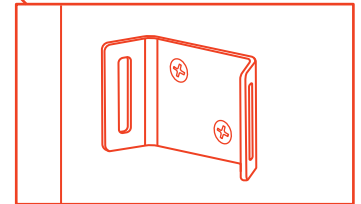
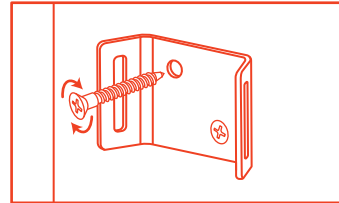

4

Fasten the strap

Move the shelf unit back against the wall. Feed the Velcro Tape strap through the two slots in the back of the fixed shelf. Fold one side flat against the fixed shelf before folding the other side over it and pressing firmly along the length of the tape to secure the strap. There should be a minimum of 1.5" overlap on the strap. Excess can be cut.

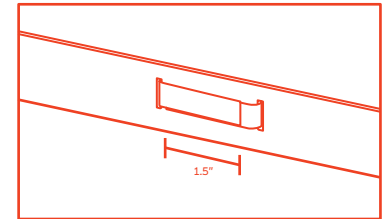
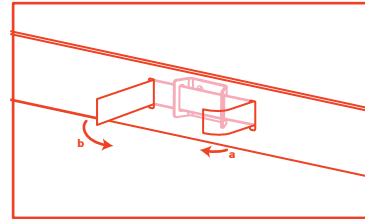

5

**You're
done!**

**Don't be shy –
we'd love to see your
shelf's new home!**

@floyddetroit
#thefloydshelf

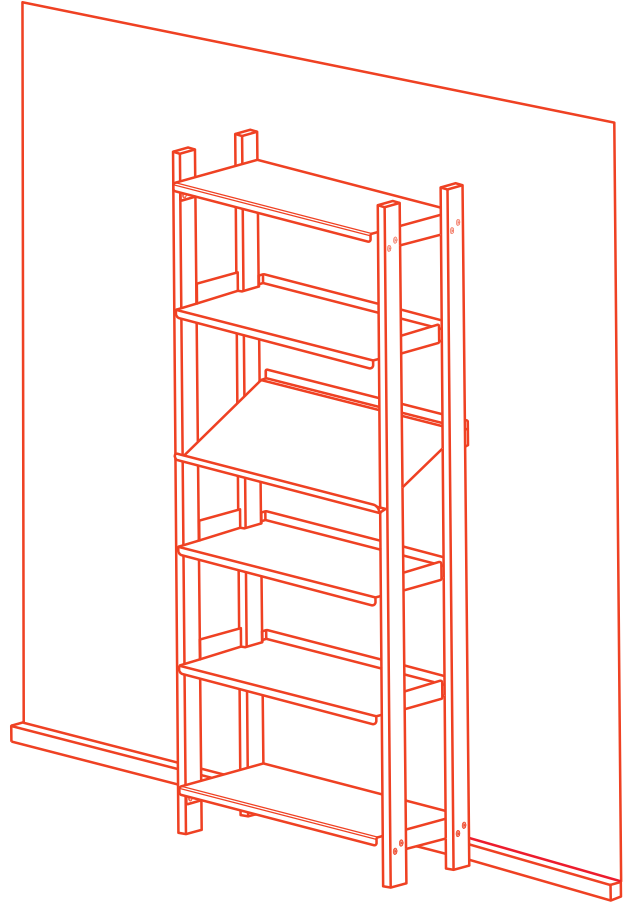



Adding a...

- Display Shelf?
- Tall Shelf?
- Short Shelf?
- Wardrobe?

First, choose which side you wish to attach the additional shelf to. Release the fasteners on the fixed shelves on that side. The same fasteners will be used to attach new fixed shelves to the wood supports.

Attach the new shelf(s) to the two new wood supports on the outside. Then, using the fasteners from the first shelf, attach all shelf(s) to the shared center wood supports.

After tightening all fasteners, add the new shelf(s) from the back.

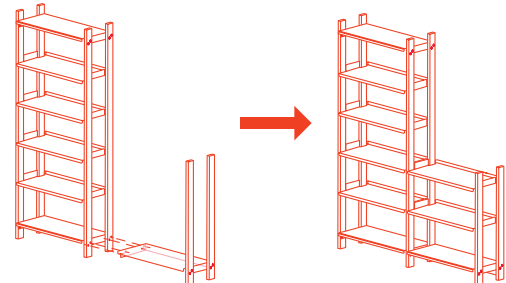
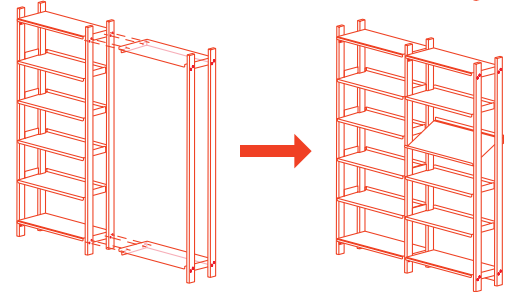
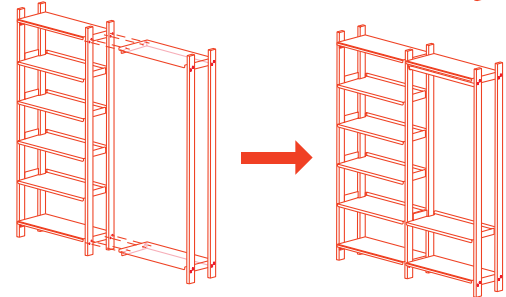
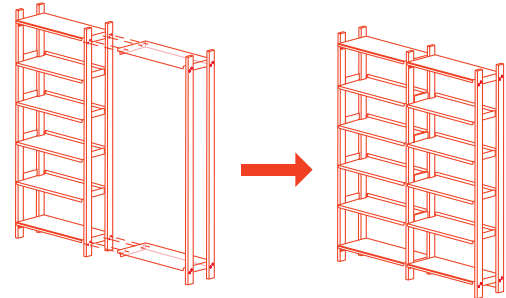

⚠ WARNING

ASSEMBLY:

Only assemble as shown in these instructions. Use extra precaution when assembling and have someone assist you. Do not change the specifications or modify this product. Incorrect assembly can cause product to fail and cause personal injury.

FURNITURE TIP-OVER:

Serious or fatal crushing injuries can occur from furniture tip-over. To help prevent tip-over, the Wall Anchor Kit should be installed per these instructions.

To further reduce the risk of furniture tip-overs:

- Place heaviest items in the lowest shelves.
- Do not set TVs or other heavy objects on the top of the Shelving System.
- Never allow children to climb or hang on shelves.

Note that the use of the Wall Anchor Kit may only reduce, but not eliminate, the risk of tip-over. For safe mounting, it is essential to use wall anchors appropriate to your wall type (i.e. plaster, drywall, concrete, etc). Mount to wood studs whenever possible.

NOTE: If you are unsure about your wall type or what mounting method you should use, consult a qualified professional or your local hardware store.

USAGE:

Remove all packaging before first use. Only place The Shelving System on the floor against a wall. Use only indoors. Disassemble before moving. The maximum weight limit per shelf is 65 lbs (29.5 kg). The maximum weight limit for the wardrobe bar is 50 lbs (22.6 kg). Do not exceed these weight limits. Inspect fastener connections and wall anchor system regularly for signs of wear. Replace if metal parts are worn, bent, rusted, deformed, or damaged. The components included with the Shelving System are only intended for use with the Floyd Shelving System. Failure to observe recommended practices such as loading beyond capacities can result in unsafe conditions and product damage or personal injury.

CHILDREN:

Young children may be injured by tipping furniture and the use of the Wall Anchor Kit provided is highly recommended. The Wall Anchor Kit is only a deterrent. It is not a substitute for proper adult supervision. Never allow children to climb or hang on the shelves. Keep all packaging and small parts away from children to prevent the risk of choking and suffocation.

CARE:

Metal shelves and wood supports can be dusted with a clean, soft, dry and lint free cloth. Spills can be cleaned with a damp rag. Hardware can loosen over time. Check fasteners occasionally to make sure all connections are secure, and re-tighten if necessary.

CONTACT

Have a question,
comment, or suggestion?
Just want to say hi?

hello@floydhome.com

FLOYDHOME.COM

Visit the Floyd Shop

The Floyd Shop
1948 Division St. Suite 101
Detroit, MI 48207

FLOYD

FLOYDHOME.COM