



METRIE



INTERIOR MOULDING & TRIM

Southeast US



WE ARE METRIE

For nearly a century, we've honed our love of beautiful millwork to deliver solutions beyond measure. Our focus on high-quality products and dedication to providing personalized support have helped us grow from a small, family-owned business into the largest supplier and manufacturer of solid wood and composite moulding in North America.

EXCEPTIONAL EXPERIENCES, EVERY DAY

We're more than a millwork company. We're a trusted partner serving those in the pursuit of a remarkable home.

Metrie creates high-quality, finely crafted architectural elements that help people transform houses into homes. Because we understand that when you're home, you're whole.

EXTENSIVE REACH WITH A LOCAL FEEL

Metrie has the broad reach and supply chain expertise of an industry leader with the personal touch of a family business.

We operate six domestic manufacturing facilities between the U.S. and Canada, and we are the largest manufacturer of MDF moulding in North America.



TAILORED SOLUTIONS

We listen to our customers to interpret trends and solve pain points so we can make it easier for them to succeed.

Our mills allow us the flexibility to provide the right solutions to the markets we serve, understanding regional differences and adhering to strict specification standards.

the
finished
space

Get inspired today with
the Finished Space
[thefinishedspace.com](https://www.thefinishedspace.com)



TABLE OF CONTENTS

- 6 Architraves
- 7 Back Bands
- 9 Baseboards
- 16 Baseboard Caps
- 17 Baseboard Shoes
- 18 Casings
- 31 Chair Rails
- 34 Crowns
- 44 Door Stops
- 45 Flat Stock
- 45 Jamb
- 46 Mullions
- 47 Panel Moulds
- 49 Stools
- 50 Miscellaneous
- 57 Notes
- 59 Index



STORAGE, HANDLING, AND PREPARATION OF ALL MOULDINGS AND S4S BOARDS

Prior to installation, it is important to acclimate your moulding and trim products by storing them in the installation space for at least 3 days. Wood and wood based products can expand and contract depending on internal and external environmental moisture levels. For best results, be sure to store products in a dry location and transport only if fully protected from water. Keep products clean from dirt and debris and finish according to paint and stain manufacturers' recommendations.



- 1 ARCHITRAVES:** In classical architecture, it described the main beam resting on the tops of the columns. Today it is often used as a decorative moulding for ornamentation or finishing at the top of windows and doors.
- 2 BASEBOARDS:** Baseboards are placed along the wall at the floor. They should be chosen to work in harmony with your casings to finish and tie the room together. Baseboards are usually thinner than the casing.
- 3 BUILD-UPS:** Combining two or more moulding profiles to create a new or custom look. Also called stacking, build-ups make it easy to create the look of custom made trimwork without the high cost.
- 4 CASINGS:** Casings define the overall character of a room and are often the most visible part of the trim. They are used primarily to cover the gap between drywall and the door or window frame. Casings are generally thicker than the base mouldings.
- 5 CROWNS:** Crowns are placed along the wall at the ceiling. They come in a wide range of patterns and sizes. Crowns soften the transition from wall to ceiling while adding a distinctive look and charm to your room.
- 6 FINISH BOARDS:** Finish Boards come in either S4S (Surfaced 4 Sides) or S3S (Surfaced 3 Sides) and are used for a multitude of purposes including shelving, window liner, bases, casing, etc.
- 7 PANEL MOULDS:** Panel Moulds are used to frame wall paneling and add an accent to your walls. Often used in furniture construction.
- 8 RAKE MOULD:** Rakes are often used as crowns. In fact, they are sometimes called "solid crowns".
- 9 WAINSCOT:** Trimwork installed in the area below a chair rail. Numerous options are available including raised panel, shadow box and beaded. Combined with a chair rail and baseboard, Wainscoting creates a dramatic look to any room.
- 10 WINDOW STOOL:** Also called window sill, a Window Stool is the surface installed below the sash of a window. Trim installed under window stool creates a distinctive look and adds a decorative touch.

ARCHITRAVES

ARCHITRAVES

High above windows and doors, architraves work to add grandeur to any space – reducing miter lines and elevating your look. A great architrave is, above all else, the dressing that's built to impress.

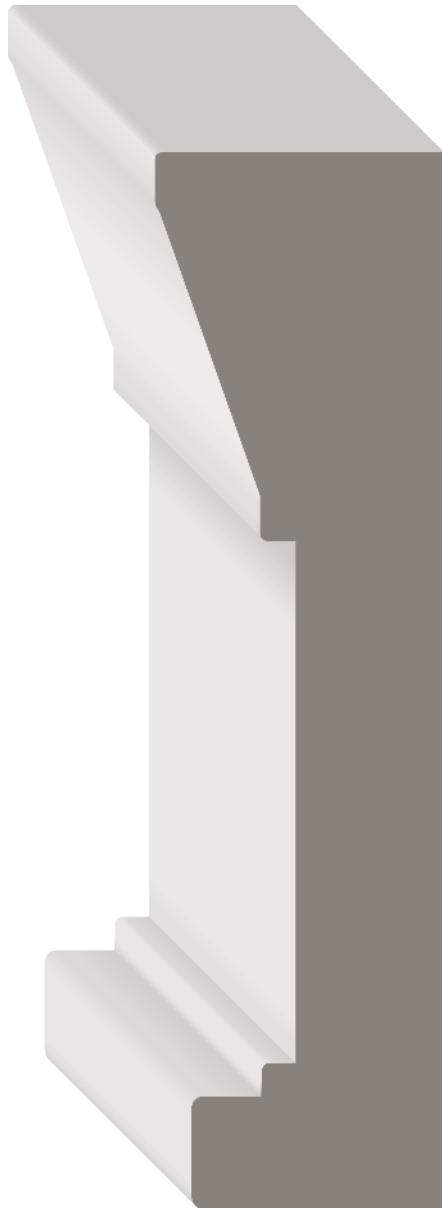

STOCK CODE
A MFP50151½" x 5½" x 16'
(1677969)
MDF/UL



STOCK CODE
A 5030M 1¾" x 6¼" x 16'
(1382895)
MDF/UL

BACK BANDS

Back bands are used in conjunction with casing or baseboard to create a wide variety of trim options for windows and doors.



STOCK CODE **DIMENSIONS**
A 1686891 1 1/16" x 1 1/16" x 17'

PFJ

C 1674183 1 1/16" x 1 1/16" x 17'

FJR

280 1 1/4" x 1 1/16" x RL
 (1382696)

PIN

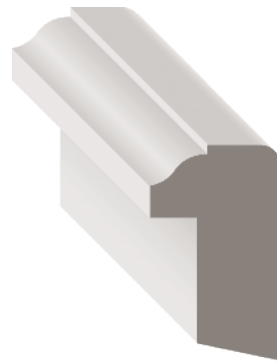

STOCK CODE **DIMENSIONS**
C 1684003 1 1/16" x 1 1/16" x 16'

PFJ

281 1 1/16" x 1 1/16" x RL
 (1394402)

PIN

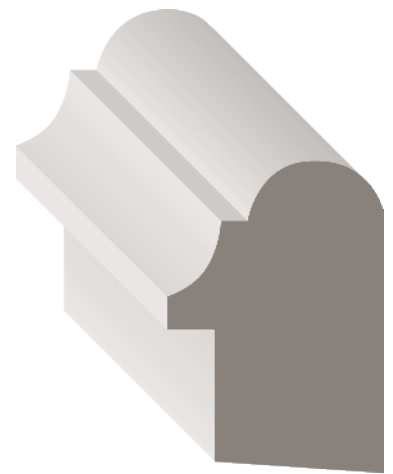

STOCK CODE **DIMENSIONS**
A 284P 1 1/8" x 1 5/8" x 17'
 (1394407)

PFJ

BACK BANDS

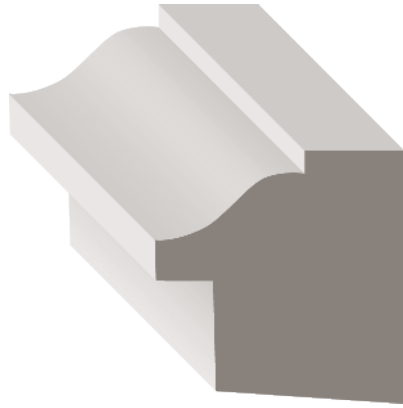

STOCK CODE **A** 1674680 DIMENSIONS $1\frac{5}{16}'' \times 1\frac{5}{16}'' \times 17'$
PFJ

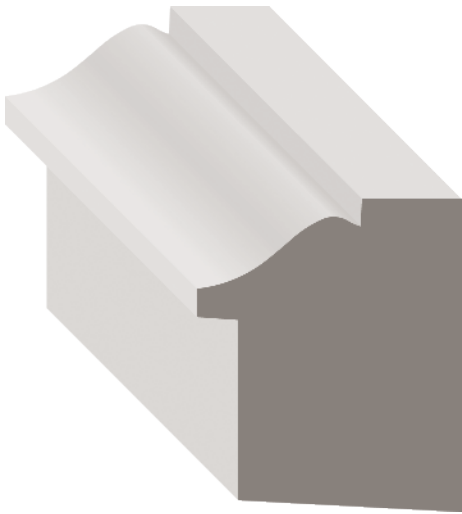

STOCK CODE 282FJ DIMENSIONS $1\frac{5}{8}'' \times 1\frac{3}{8}'' \times 17'$
(1394406) FJR

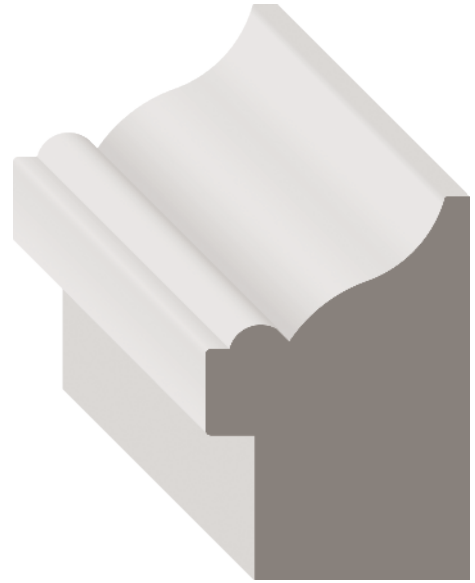

STOCK CODE **A** 200P DIMENSIONS $1\frac{3}{8}'' \times 2'' \times 17'$
(1394361) PFJ

BASEBOARDS

Your look starts here – at the foundation of a room. A great baseboard complements a casing and creates a smooth transition from the wall to the floor, guiding you seamlessly from room to room.



STOCK CODE
623MD
(1566985)

DIMENSIONS
1/2" x 3 1/4" x 16'

MDF/UL

623FJ
(1382944)

3/16" x 3 1/4" x 16'

FJR

623P
(1382947)

3/16" x 3 1/4" x 16'

PFJ

A **623** 3/16" x 3 1/4" x RL
(1382942)

PIN



STOCK CODE
620FJ
(1567253)

DIMENSIONS
3/16" x 4 1/4" x 16'

FJR

620M
(1382937)

1/2" x 4 1/4" x 16'

MDF/UL

620P
(1394610)

3/16" x 4 1/4" x 16'

PFJ



STOCK CODE
A 618FJ 3/16" x 5 1/4" x 16'
(1567252)

FJR

618M
(1382932)

1/2" x 5 1/4" x 16'

MDF/UL

618P
(1382933)

3/16" x 5 1/4" x 16'

PFJ

BASEBOARDS

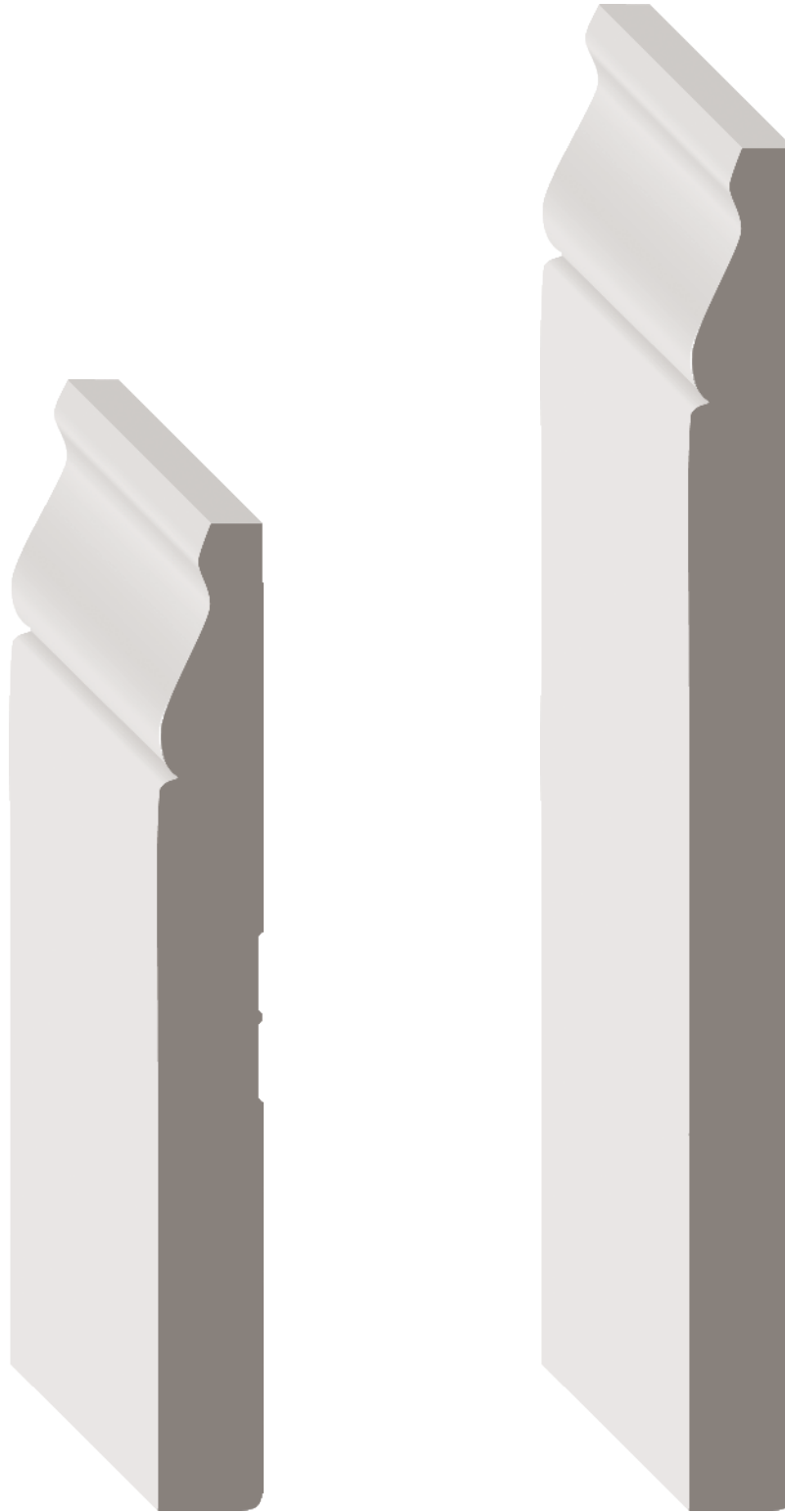

STOCK CODE **DIMENSIONS**

163ESFJ $\frac{9}{16}$ " x 5 $\frac{1}{4}$ " x 16'
(1382550)

A 163E7SFJ $\frac{9}{16}$ " x 7 $\frac{1}{4}$ " x 16'
(1670870)

FJR

163EMD $\frac{9}{16}$ " x 5 $\frac{1}{4}$ " x 16'
(1394288)

A 163E 1 $\frac{1}{16}$ " x 5 $\frac{1}{4}$ " x 16'
(1394336)

163E7MD $\frac{9}{16}$ " x 7 $\frac{1}{4}$ " x 16'
(1394281)

163E9M $\frac{9}{16}$ " x 9 $\frac{1}{4}$ " x 16'
(1394285)

MDF/UL

A 163EP 1 $\frac{1}{16}$ " x 5 $\frac{1}{4}$ " x 16'
(1382548)

163ESP $\frac{9}{16}$ " x 5 $\frac{1}{4}$ " x 16'
(1382551)

163E7SP $\frac{9}{16}$ " x 7 $\frac{1}{4}$ " x 16'
(1394284)

PFJ

163E 1 $\frac{1}{16}$ " x 5 $\frac{1}{4}$ " x RL
(1461928)

A **PIN**

STOCK CODE **DIMENSIONS**

A 1394337 1 $\frac{1}{16}$ " x 7 $\frac{1}{4}$ " x 16'

MDF/UL

163E7P 1 $\frac{1}{16}$ " x 7 $\frac{1}{4}$ " x 16'
(1382542)

PFJ



STOCK CODE	DIMENSIONS
163EMSD (1394289)	1/2" x 5 1/4" x 16'
163E7MS (1394282)	1/2" x 7 1/4" x 16'

MDF/UL



STOCK CODE	DIMENSIONS
C 1382989	3/16" x 5 1/4" x 16'
	PFJ
A 750WM (1382988)	1/2" x 5 1/4" x 16'
A 1681669	1/2" x 7 1/4" x 16'

MDF/UL



STOCK CODE	DIMENSIONS
A MFPU8281 (1626223)	1/2" x 6" x 16'

MDF/UL

BASEBOARDS



STOCK CODE
713P
(1382973)

DIMENSIONS
 $\frac{1}{16}$ " x $3\frac{1}{4}$ " x 16'

PFJ



713 $\frac{1}{16}$ " x $3\frac{1}{4}$ " x RL
(1382972)

PIN



STOCK CODE
1692574

DIMENSIONS
 $\frac{1}{16}$ " x $4\frac{1}{4}$ " x 16'

PFJ



STOCK CODE
1692576

DIMENSIONS
 $\frac{1}{16}$ " x $5\frac{1}{4}$ " x 16'

PFJ



STOCK CODE **DIMENSIONS**
A 631LP $\frac{9}{16}$ " x 5 $\frac{1}{4}$ " x 16'
 (1416244) **PFJ**

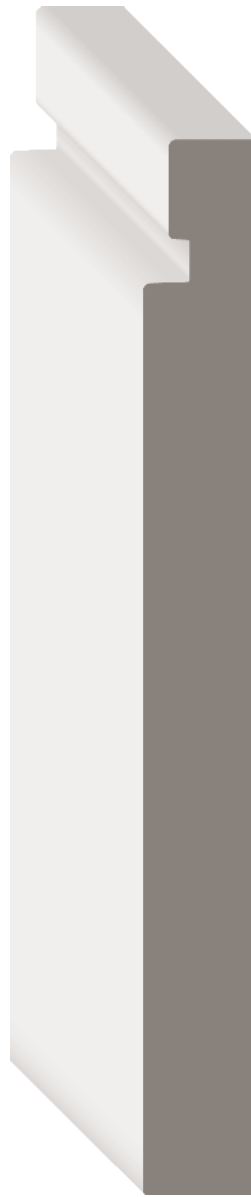

STOCK CODE **DIMENSIONS**
 CVS1B2PMD $\frac{9}{16}$ " x 5 $\frac{1}{2}$ " x 16'
 (1323956)
 CVS1B3PMD $\frac{9}{16}$ " x 7 $\frac{1}{4}$ " x 16'
 (1674704) **MDF/UL**



STOCK CODE **DIMENSIONS**
C 3850BMD $\frac{9}{16}$ " x 5 $\frac{1}{2}$ " x 16'
 (1405168) **MDF/UL**
 1462168 $\frac{9}{16}$ " x 4 $\frac{1}{4}$ " x 16'
PFJ

BASEBOARDS



STOCK CODE
A 1680231 $\frac{1}{16}$ " x 5 $\frac{1}{2}$ " x 16'

PFJ



STOCK CODE
 1680232 $\frac{1}{16}$ " x 7 $\frac{1}{4}$ " x 16'

PFJ



STOCK CODE
 1692568 $\frac{1}{16}$ " x 5 $\frac{1}{4}$ " x 16'

PFJ

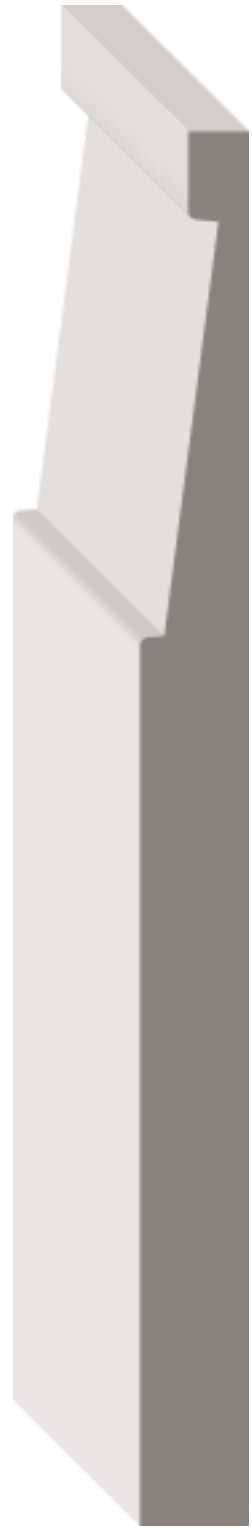

STOCK CODE
 1692569 $\frac{1}{16}$ " x 7 $\frac{1}{4}$ " x 16'

PFJ



STOCK CODE **C** 1382822 $\frac{3}{16}$ " x 3½" x 16'
 DIMENSIONS
 PFJ



STOCK CODE 320BM (1405121) $1\frac{1}{16}$ " x 4¼" x 17'
 DIMENSIONS
 MDF/UL



STOCK CODE **C** 1393458 $\frac{3}{16}$ " x 5½" x 16'
 DIMENSIONS
 PFJ

BASEBOARD CAPS

BASEBOARD CAPS

Baseboard caps are added to the top of regular baseboard moulding and flush to the wall to create a finished and more complex architectural moulding.



STOCK CODE
163FJ
(1382553)

DIMENSIONS
1¹/₁₆" x 1³/₈" x 16'

FJR

STOCK CODE
163P
(1394296)

DIMENSIONS
1¹/₁₆" x 1³/₈" x 16'

PFJ

STOCK CODE
163
(1394276)

DIMENSIONS
1¹/₁₆" x 1³/₈" x RL

PIN



STOCK CODE
172
(1394325)

DIMENSIONS
5/8" x 3/4" x RL

PIN

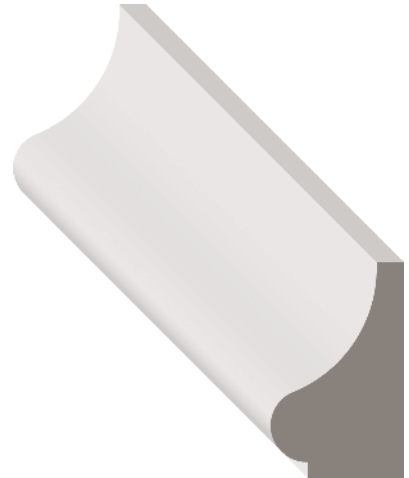

STOCK CODE
C 167P
(1382569)

DIMENSIONS
1¹/₁₆" x 1¹/₈" x 16'

PFJ

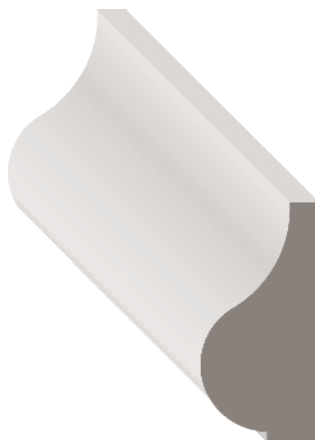

STOCK CODE
C 166
(1382563)

DIMENSIONS
5/8" x 1¹/₄" x RL

PIN



STOCK CODE
A BC150FJP
(1394672)

DIMENSIONS
2¹/₃₂" x 1¹³/₃₂" x 16'

PFJ

BASEBOARD SHOES

Baseboard shoes are primarily used to trim flooring materials and are often used in combination with a traditional baseboard to conceal variations between the flooring and the base. However, this versatile profile works great to solve numerous trimming needs.



STOCK CODE
A 1682127 $\frac{1}{2}'' \times \frac{3}{4}'' \times 16'$

LVL

1521266 $\frac{1}{2}'' \times \frac{3}{4}'' \times 16'$

PFJ

1260
 (1394234) $\frac{1}{2}'' \times \frac{3}{4}'' \times RL$

O

126
 (1461861) $\frac{1}{2}'' \times \frac{3}{4}'' \times RL$

PIN



STOCK CODE
1270
 (1394236) $\frac{3}{8}'' \times \frac{3}{4}'' \times RL$

O



STOCK CODE
A **129P** $\frac{7}{16}'' \times \frac{11}{16}'' \times 16'$
 (1676530)

LVL

1382479 $\frac{7}{16}'' \times \frac{11}{16}'' \times 16'$

PFJ

129
 (1394238) $\frac{7}{16}'' \times \frac{11}{16}'' \times RL$

PIN

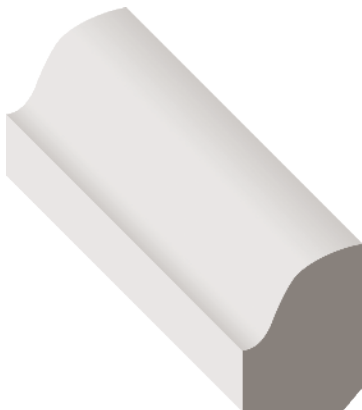

STOCK CODE
C **131** $\frac{1}{2}'' \times \frac{3}{4}'' \times RL$
 (1472771)

PIN

CASINGS

Casings bring a room together – left to right, top to bottom. And like any framing element, the options are endless, from build-ups of multiple pieces to full wraps. With casings, there's no wrong way, only your way.

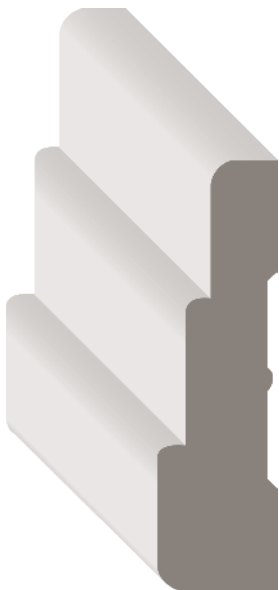

STOCK CODE **DIMENSIONS**
A 387P $\frac{5}{8}$ " x 2 $\frac{1}{4}$ " x 16'
 (1394478) **PFJ**

A 387 $\frac{5}{8}$ " x 2 $\frac{1}{4}$ " x RL
 (1394477) **PIN**



STOCK CODE **DIMENSIONS**
A 324FJ185 $1\frac{1}{16}$ " x 2 $\frac{1}{4}$ " x 85"
 (1394425) **FJR**

A 324P $1\frac{1}{16}$ " x 2 $\frac{1}{4}$ " x 16'
 (1394427)
A 324PI85 $1\frac{1}{16}$ " x 2 $\frac{1}{4}$ " x 85"
 (1637309) **PFJ**

A 324 $1\frac{1}{16}$ " x 2 $\frac{1}{4}$ " x RL
 (1521753)
A 324I85 $1\frac{1}{16}$ " x 2 $\frac{1}{4}$ " x 85"
 (1394426) **PIN**



STOCK CODE **DIMENSIONS**
 327P $1\frac{1}{16}$ " x 2 $\frac{1}{4}$ " x 14'
 (1382725)
A 327PI85 $1\frac{1}{16}$ " x 2 $\frac{1}{4}$ " x 85"
 (1382728) **PFJ**

327 $1\frac{1}{16}$ " x 2 $\frac{1}{4}$ " x RL
 (1382723) **PIN**



STOCK CODE **DIMENSIONS**

A 366M $\frac{3}{16}$ " x $2\frac{1}{4}$ " x 14'
(1394461)

MDF/UL

A 366PI85 $1\frac{1}{16}$ " x $2\frac{1}{4}$ " x 85"
(1394463)

366P $1\frac{1}{16}$ " x $2\frac{1}{4}$ " x 17'
(1416106)

PFJ

A 366 $1\frac{1}{16}$ " x $2\frac{1}{4}$ " x RL
(1382766)

PIN



STOCK CODE **DIMENSIONS**

C 442P $1\frac{1}{16}$ " x $2\frac{1}{4}$ " x 14'
(1394507)

PFJ



STOCK CODE **DIMENSIONS**

C 1484991 1" x $3\frac{1}{4}$ " x 16'

MDF

CASINGS

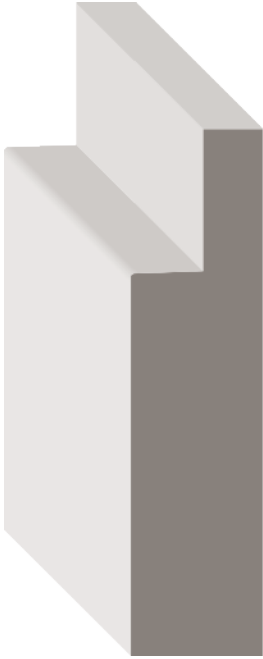

STOCK CODE
1692575

DIMENSIONS
1 1/16" x 2 3/4" x 17'

MDF



STOCK CODE
1692577

DIMENSIONS
1 1/16" x 3 1/4" x 17'

MDF



STOCK CODE
1382857

DIMENSIONS
1 1/16" x 2 1/2" x 16'

1693027 1 1/16" x 2 1/2" x 83 3/4"

PFJ



STOCK CODE
1382811

DIMENSIONS
1 1/16" x 3 1/2" x 16'

1693026 1 1/16" x 3 1/2" x 84 13/16"

PFJ



STOCK CODE	DIMENSIONS
356FJF17 (1638047)	5/8" x 2 1/4" x 17'
356FJI85 (1382743)	5/8" x 2 1/4" x 85"

FJR

356MD (1394451)	5/8" x 2 1/4" x 14'
--------------------	---------------------

MDF/UL

356PF17 (1416093)	5/8" x 2 1/4" x 17'
----------------------	---------------------

356PI85 (1382748)	5/8" x 2 1/4" x 85"
----------------------	---------------------

PFJ

A 356 (1462115)	2 1/32" x 2 1/4" x RL
---------------------------	-----------------------

A 356I85 (1394450)	2 1/32" x 2 1/4" x 85"
------------------------------	------------------------

PIN



STOCK CODE	DIMENSIONS
C 444LM (1394512)	1/16" x 3 1/4" x 16'

MDF/UL



STOCK CODE	DIMENSIONS
444LFJF17 (1394510)	1 1/16" x 3 1/4" x 17'
444LFJI87 (1394511)	1 1/16" x 3 1/4" x 87"

FJR

444LPF17 (1394513)	1 1/16" x 3 1/4" x 17'
-----------------------	------------------------

A 444LPI87 (1394514)	1 1/16" x 3 1/4" x 87"
--------------------------------	------------------------

A 1692981	1 1/16" x 3 1/2" x 102"
------------------	-------------------------

PFJ

A 444L (1382834)	1 1/16" x 3 1/4"
----------------------------	------------------

PIN

CASINGS



STOCK CODE
A 504LPF17 $1\frac{1}{16}'' \times 2\frac{3}{16}'' \times 17'$
 (1394566)

PFJ



STOCK CODE
A 401LP $1\frac{1}{16}'' \times 2\frac{3}{4}'' \times 17'$
 (1394491)

A 401LP187 $1\frac{1}{16}'' \times 2\frac{3}{4}'' \times 87''$
 (1394492)

PFJ



STOCK CODE
A H8P $\frac{7}{8}'' \times 3'' \times 17'$
 (1404807)

PFJ



STOCK CODE
A 522P $\frac{3}{4}'' \times 3\frac{1}{2}'' \times 17'$
 (1394577)

PFJ



STOCK CODE	DIMENSIONS
1693028	1 ¹ / ₁₆ " x 2 ¹ / ₄ " x 83 ¹ / ₂ "
376PF17 (1394471)	1 ¹ / ₁₆ " x 2 ¹ / ₄ " x 17'

PFJ



STOCK CODE	DIMENSIONS
445FJF17 (1394516)	1 ¹ / ₁₆ " x 3 ¹ / ₄ " x 17'
445FJI87 (1382841)	1 ¹ / ₁₆ " x 3 ¹ / ₄ " x 87"
A 445FJI102 (1405210)	1 ¹ / ₁₆ " x 3 ¹ / ₄ " x 102"

FJR

445M (1382843)	9 ¹ / ₁₆ " x 3 ¹ / ₄ " x 16'
-------------------	--

MDF/UL

445PF17 (1394520)	1 ¹ / ₁₆ " x 3 ¹ / ₄ " x 17'
445PI87 (1382849)	1 ¹ / ₁₆ " x 3 ¹ / ₄ " x 87"

PFJ



STOCK CODE	DIMENSIONS
A 371FJI86 (1670585)	1 ¹ / ₁₆ " x 2 ¹⁵ / ₁₆ " x 86"
A 1685927	1 ¹ / ₁₆ " x 2 ¹⁵ / ₁₆ " x 17'

FJR

A 371P (1394465)	1 ¹ / ₁₆ " x 2 ¹⁵ / ₁₆ " x 15'
----------------------------	--

PFJ



STOCK CODE	DIMENSIONS
A 361PF17 (1394457)	1 ¹ / ₁₆ " x 3 ¹ / ₄ " x 17'
A 361PI87 (1394458)	1 ¹ / ₁₆ " x 3 ¹ / ₄ " x 87"

PFJ

CASINGS

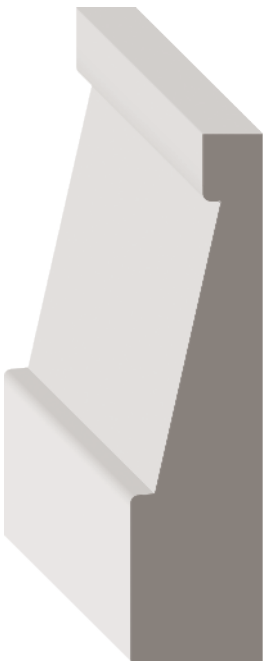

STOCK CODE
1692570

DIMENSIONS
1¹/₁₆" x 2³/₄" x 17'

PFJ

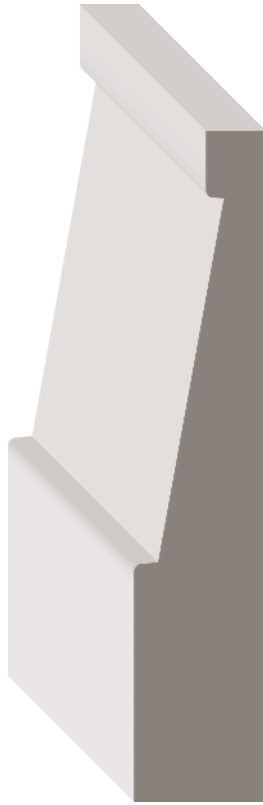

STOCK CODE
1692571

DIMENSIONS
1¹/₁₆" x 3¹/₂" x 17'

PFJ

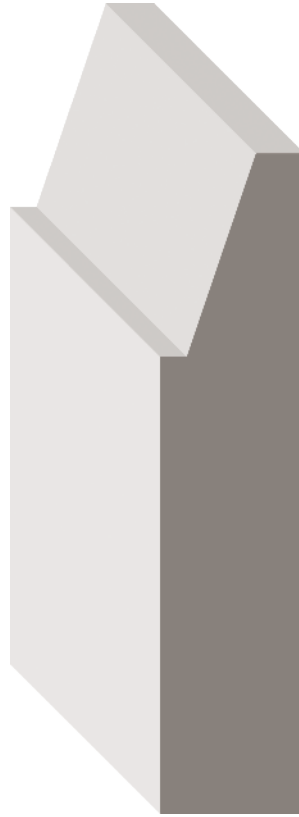

STOCK CODE
A 1683696

DIMENSIONS
1¹/₁₆" x 3¹/₂" x 17'

PFJ



STOCK CODE
1682984

DIMENSIONS
3/4" x 3¹/₂" x 17'

MDF/UL



STOCK CODE **DIMENSIONS**
A 1677973 $\frac{5}{8}$ " x $3\frac{1}{4}$ " x 17'
MDF/UL



STOCK CODE **DIMENSIONS**
C 1680633 $1\frac{1}{16}$ " x $3\frac{1}{16}$ " x 17'
PFJ



STOCK CODE **DIMENSIONS**
A 481SFJF17 $1\frac{1}{16}$ " x $3\frac{1}{2}$ " x 17'
 (1671103) **FJR**

A 481BBM $1\frac{1}{16}$ " x $3\frac{1}{2}$ " x 16'
 (1394546)
A 481BBMI90 $1\frac{1}{16}$ " x $3\frac{1}{2}$ " x 90"
 (1394547) **MDF/UL**

CASINGS



STOCK CODE **DIMENSIONS**
A 534P 1¹/₁₆" x 3¹/₂" x 17'
 (1394589)
PFJ



STOCK CODE **DIMENSIONS**
A ZZRB9828FJ 1¹/₄" x 3¹/₂" x 17'
 (1670861)
FJR



STOCK CODE **DIMENSIONS**
A 399PF17 2⁹/₃₂" x 3⁷/₃₂" x 17'
 (1394487)
A 399PI88 2⁹/₃₂" x 3⁷/₃₂" x 88"
 (1394488)
A 1678975 2⁹/₃₂" x 3⁷/₃₂" x 103"
PFJ
A 399 1⁵/₁₆" x 3¹/₄" x RL
 (1644963)
PIN



STOCK CODE
97P
(1383101)

DIMENSIONS
1 1/16" x 3 1/2" x 16'

PFJ



STOCK CODE
C 470FJ
(1394535)

DIMENSIONS
1 1/16" x 3 3/4" x 17'

FJR

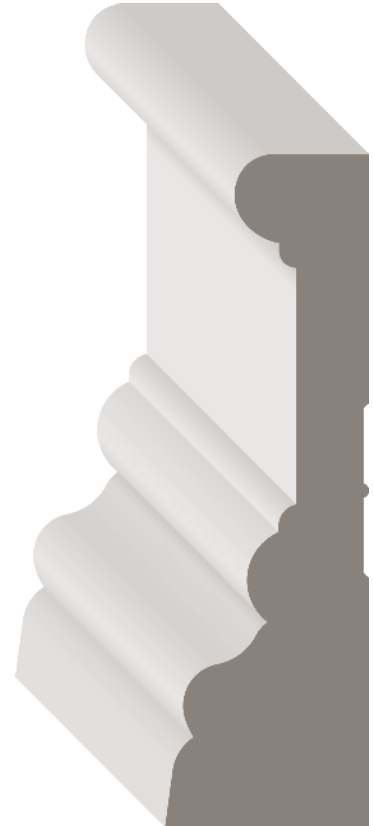

STOCK CODE
523FJ
(1394578)

DIMENSIONS
1 1/16" x 3 1/2" x 17'

FJR

STOCK CODE
523FJI88
(1394580)

DIMENSIONS
1 1/16" x 3 1/2" x 88"

FJR

STOCK CODE
523FJI102
(1394579)

DIMENSIONS
1 1/16" x 3 1/2" x 102"

FJR

STOCK CODE
523M
(1382899)

DIMENSIONS
1" x 3 1/2" x 16'

MDF/UL

STOCK CODE
523P
(1462226)

DIMENSIONS
1 1/8" x 3 1/2" x 17'

STOCK CODE
A 523PI88
(1394584)

DIMENSIONS
1 1/8" x 3 1/2" x 88"

PFJ

CASINGS

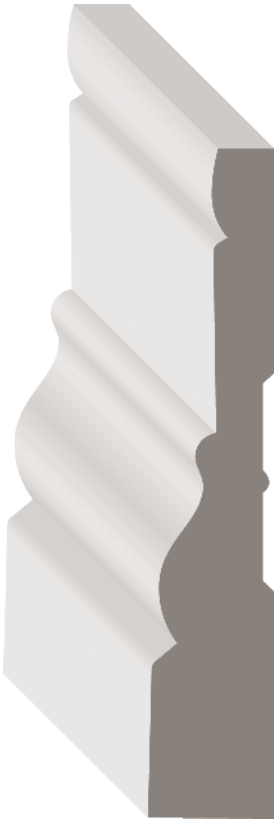

STOCK CODE
A 553P 1 1/16" x 3 1/2" x 17'
 (1394594)

DIMENSIONS
 PFJ



STOCK CODE
A 341P 1 1/16" x 3 1/2" x 17'
 (1394438)

DIMENSIONS
A 341PI88 1 1/16" x 3 1/2" x 88"
 (1394439)
 PFJ



STOCK CODE
A 350P 1 1/16" x 3 1/2" x 17'
 (1394446)

DIMENSIONS
 PFJ



STOCK CODE
A 425P 1 1/16" x 4 1/4" x 17'
 (1394499)

DIMENSIONS
 PFJ



STOCK CODE **DIMENSIONS**
A 524P 1" x 4¼" x 17'
 (1394585) **PFJ**



STOCK CODE **DIMENSIONS**
 481BP 1¾" x 4¼" x 17'
 (1394548) **PFJ**



STOCK CODE **DIMENSIONS**
A 1394548 ½" x 4¼" x 17'
PIN

CASINGS

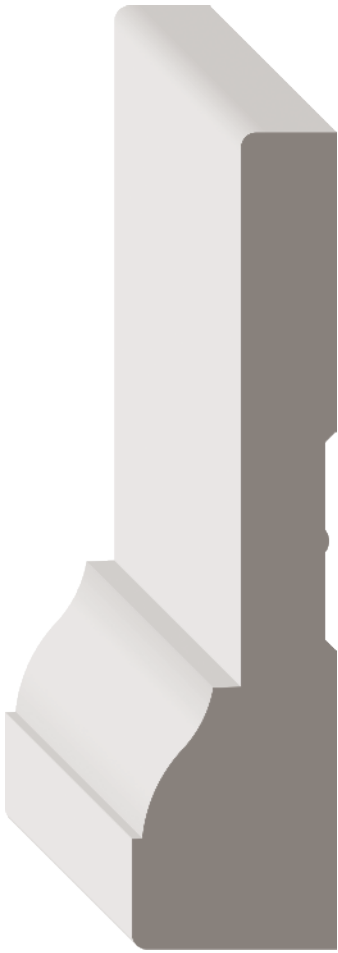

STOCK CODE
A 1394549 **DIMENSIONS**
 1 1/16" x 4 1/4" x 17'

PIN



STOCK CODE
A 481PF17 **DIMENSIONS**
 1 3/16" x 4 9/16" x 17'
 (1394549)

PFJ



STOCK CODE
A 600P **DIMENSIONS**
 5/8" x 3 1/2" x 16'
 (1394597)

PFJ

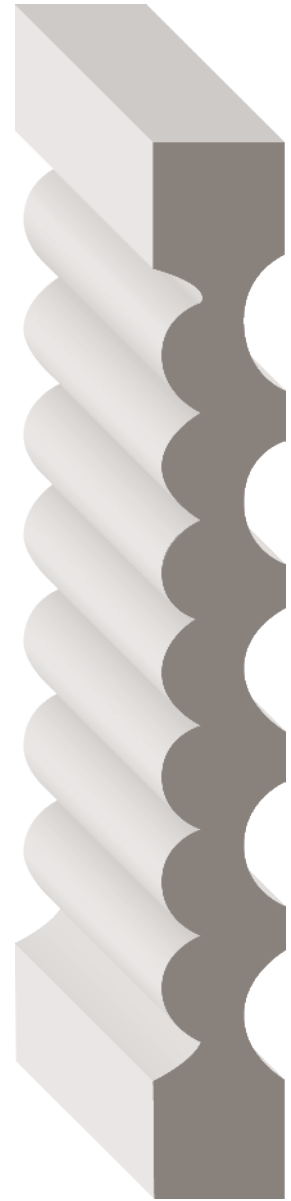

STOCK CODE
A 606P **DIMENSIONS**
 1 1/16" x 5 1/2" x 16'
 (1394599)

PFJ

CHAIR RAILS

The chair rail runs along the wall, parallel with the baseboard. Adding a refined decor to any space, it's the subtle choice that makes a big impact. The chair rail perfectly complements a wainscot design.



STOCK CODE
390P
(1382796)

DIMENSIONS
1 1/16" x 2 5/8" x 16'

PFJ



STOCK CODE
298FJ
(1394411)

DIMENSIONS
1 1/16" x 2 3/4" x 16'

FJR

STOCK CODE
298P
(1394412)

DIMENSIONS
1 1/16" x 2 3/4" x 16'

PFJ

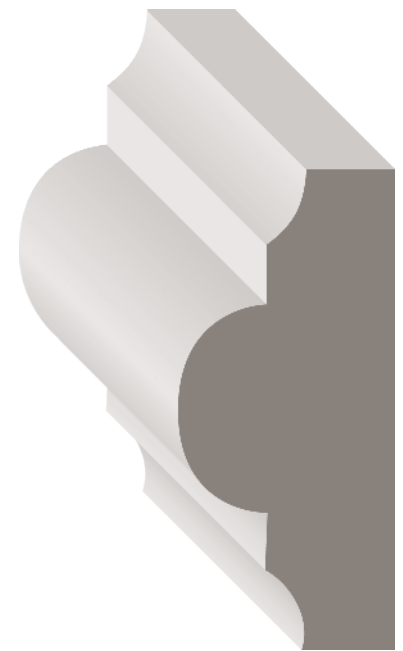

STOCK CODE
299FJ
(1670589)

DIMENSIONS
1 1/8" x 2 1/2" x 16'

FJR

STOCK CODE
299P
(1394413)

DIMENSIONS
1 1/8" x 2 1/2" x 16'

PFJ

CHAIR RAILS



STOCK CODE **A** 297P 1 1/16" x 3" x 16'
(1382708) **PFJ**



STOCK CODE **C** 394FJ 1 1/16" x 2 5/8" x 16'
(1394483) **FJR**

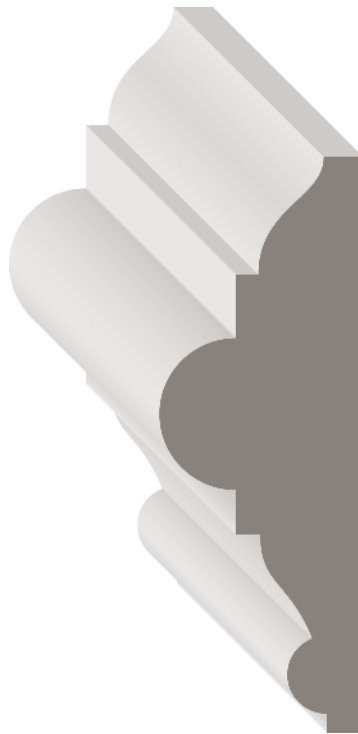

STOCK CODE **C** 300FJ 1 1/16" x 3" x 16'
(1394416) **FJR**

300P 1 1/16" x 3" x 16'
(1382712) **PFJ**



STOCK CODE 1692572 DIMENSIONS 3/16" x 3" x 16'
PFJ

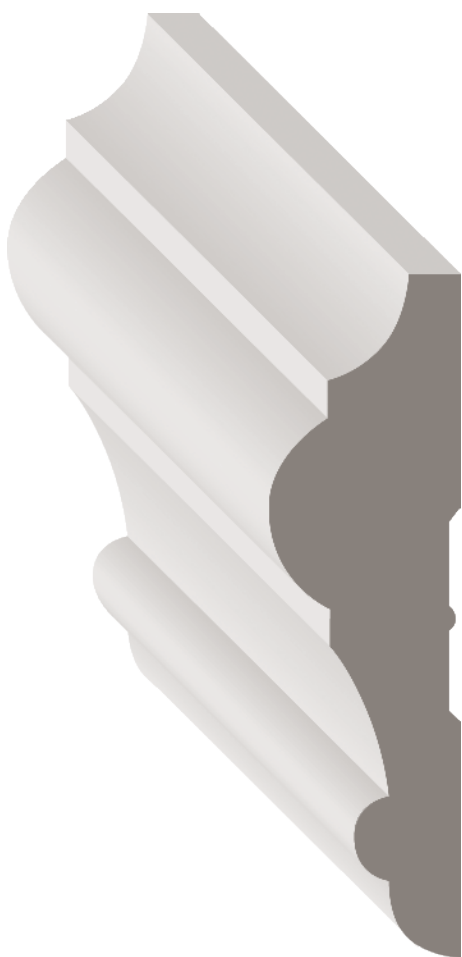

STOCK CODE **DIMENSIONS**
C 397FJ 1" x 3½" x 16'
 (1394484) **FJR**

397M 1" x 3½" x 16'
 (1382798) **MDF/UL**



STOCK CODE **DIMENSIONS**
A 957FJ ½" x 4½" x 16'
 (1394651) **FJR**

C 956WWM ½" x 4¼" x 16'
 (1383087) **MDF/UL**

957P ½" x 4½" x 16'
 (1394652) **PFJ**



STOCK CODE **DIMENSIONS**
C 398FJ ½" x 5¼" x 16'
 (1394648) **FJR**

C 956LWWM ½" x 5¼" x 16'
 (1394648) **MDF/UL**

CROWNS

Cap off your look with the perfect crown. A great crown is the royal wrap-up of all your moulding decisions.

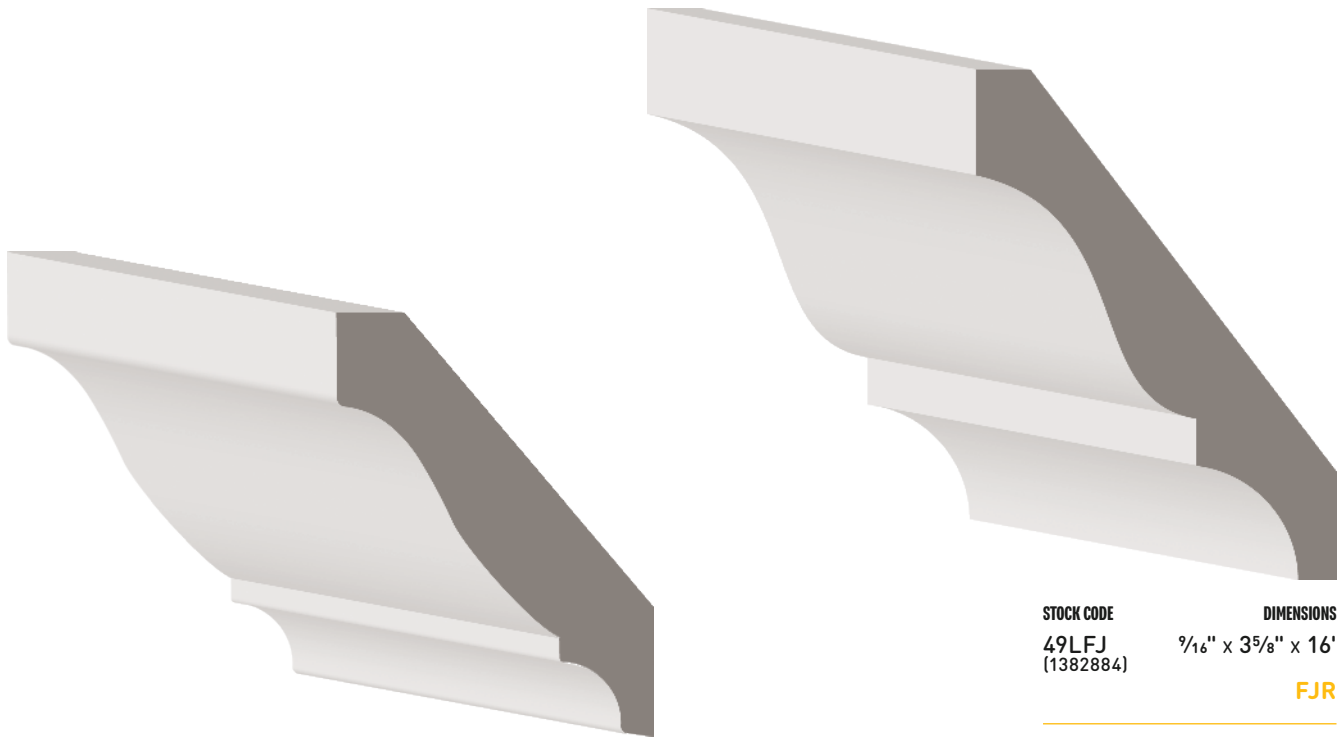

STOCK CODE **DIMENSIONS**

C 52FJ $\frac{1}{16}'' \times 2\frac{3}{4}'' \times 16'$
(1394586)

FJR

52P $\frac{1}{16}'' \times 2\frac{3}{4}'' \times 16'$
(1394587)

PFJ

52 $\frac{1}{16}'' \times 2\frac{3}{4}'' \times \text{RL}$
(1416201)

PIN

STOCK CODE
49LFJ
(1382884)

DIMENSIONS
 $\frac{1}{16}'' \times 3\frac{5}{8}'' \times 16'$

FJR

49MD
(1394558)

$\frac{1}{16}'' \times 3\frac{5}{8}'' \times 16'$

A 49SMD
(1394559)

$\frac{1}{2}'' \times 3\frac{5}{8}'' \times 16'$

MDF/UL

49LP
(1382885)

$\frac{1}{16}'' \times 3\frac{5}{8}'' \times 16'$

PFJ

49L
(1382883)

$\frac{1}{2}'' \times 3\frac{5}{8}'' \times \text{RL}$

PIN

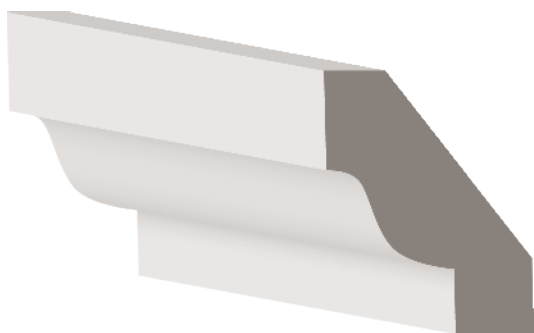

STOCK CODE
A 60 $\frac{9}{16}$ " x $1\frac{3}{4}$ " x RL
 (1394596)

DIMENSIONS

PIN

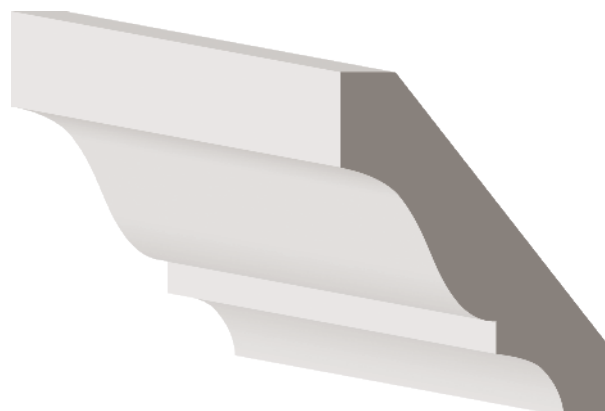

STOCK CODE
A 54P $\frac{1}{2}$ " x $2\frac{1}{4}$ " x 16'
 (1394593)

DIMENSIONS

PFJ



STOCK CODE
A 51P $\frac{9}{16}$ " x $3\frac{1}{4}$ " x 16'
 (1394575)

DIMENSIONS

PFJ

A 51 $\frac{9}{16}$ " x $3\frac{1}{4}$ " x RL
 (1394568)

PIN



STOCK CODE
A 48M $\frac{9}{16}$ " x $4\frac{1}{4}$ " x 16'
 (1394550)

DIMENSIONS

MDF/UL

A 48P $\frac{9}{16}$ " x $4\frac{1}{4}$ " x 16'
 (1394551)

PFJ

CROWNS



STOCK CODE
47LFJ
(1382873)

DIMENSIONS
 $\frac{1}{16}'' \times 4\frac{5}{8}'' \times 16'$

FJR

47M
(1394542)

$\frac{1}{16}'' \times 4\frac{5}{8}'' \times 16'$

MDF/UL

47LP
(1382874)

$\frac{1}{16}'' \times 4\frac{5}{8}'' \times 16'$

PFJ

47L
(1382872)

$\frac{1}{16}'' \times 4\frac{5}{8}'' \times 16'$

PIN

STOCK CODE
A 17FJ $1\frac{1}{16}'' \times 5\frac{5}{8}'' \times 16'$
(1394326)

DIMENSIONS

PFJ

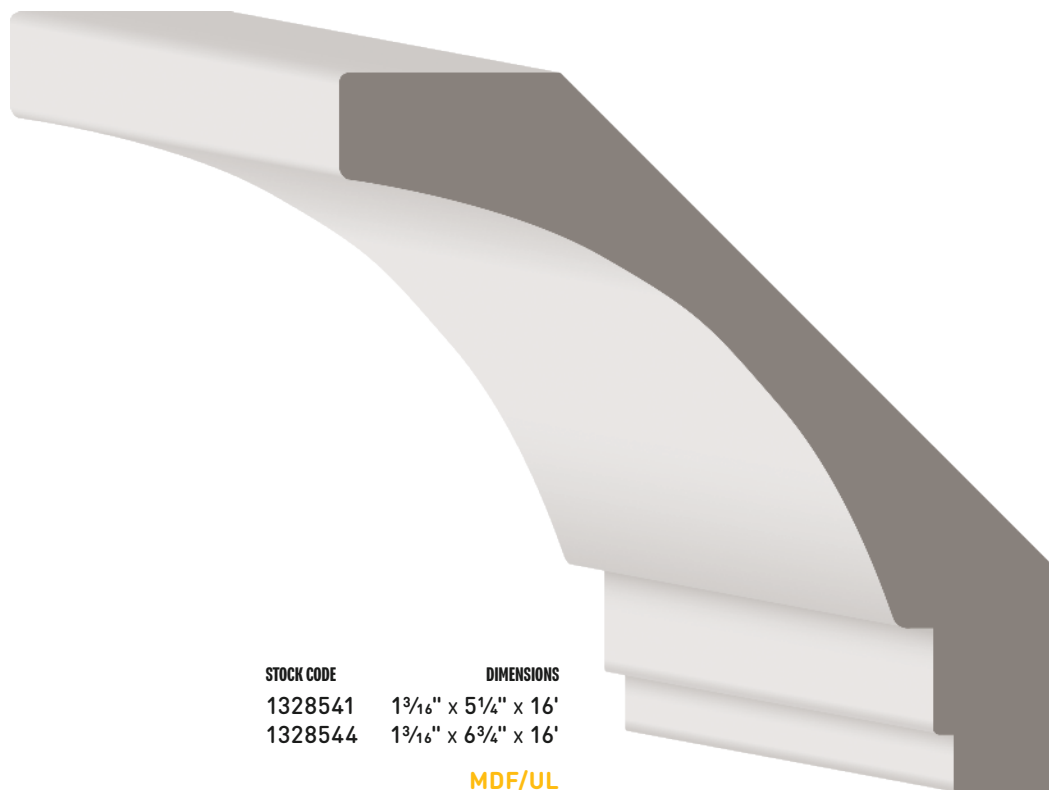
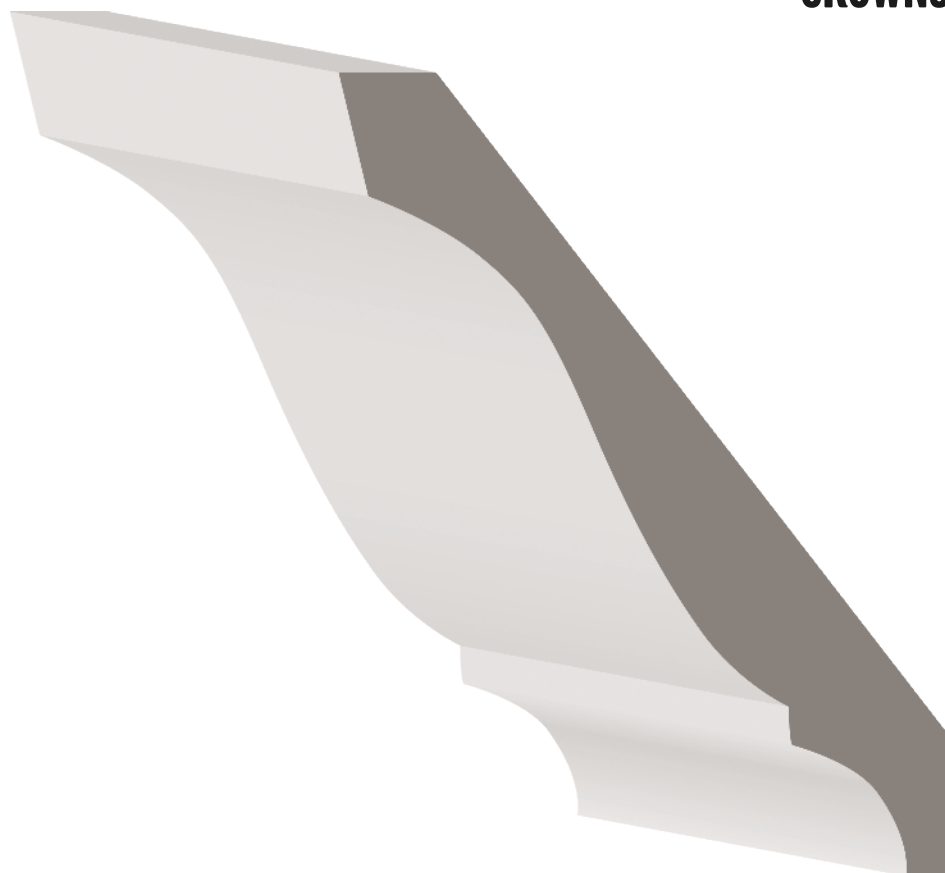

STOCK CODE	DIMENSIONS
45MD (1394528)	$\frac{9}{16}$ " x 5 $\frac{1}{4}$ " x 16'

A 45BCM (1394523)	$\frac{19}{32}$ " x 5 $\frac{1}{4}$ " x 16'
-----------------------------	---

MDF/UL

45LP (1394526)	$\frac{9}{16}$ " x 5 $\frac{1}{4}$ " x 16'
-------------------	--

A 45BCP (1394524)	$\frac{9}{16}$ " x 5 $\frac{1}{4}$ " x 16'
-----------------------------	--

45P (1382863)	1 $\frac{1}{16}$ " x 5 $\frac{1}{4}$ " x 16'
------------------	--

PFJ

45 (1394522)	$\frac{9}{16}$ " x 5 $\frac{1}{4}$ " x RL
-----------------	---

PIN

STOCK CODE	DIMENSIONS
1328541	1 $\frac{3}{16}$ " x 5 $\frac{1}{4}$ " x 16'
1328544	1 $\frac{3}{16}$ " x 6 $\frac{3}{4}$ " x 16'

MDF/UL

CROWNS

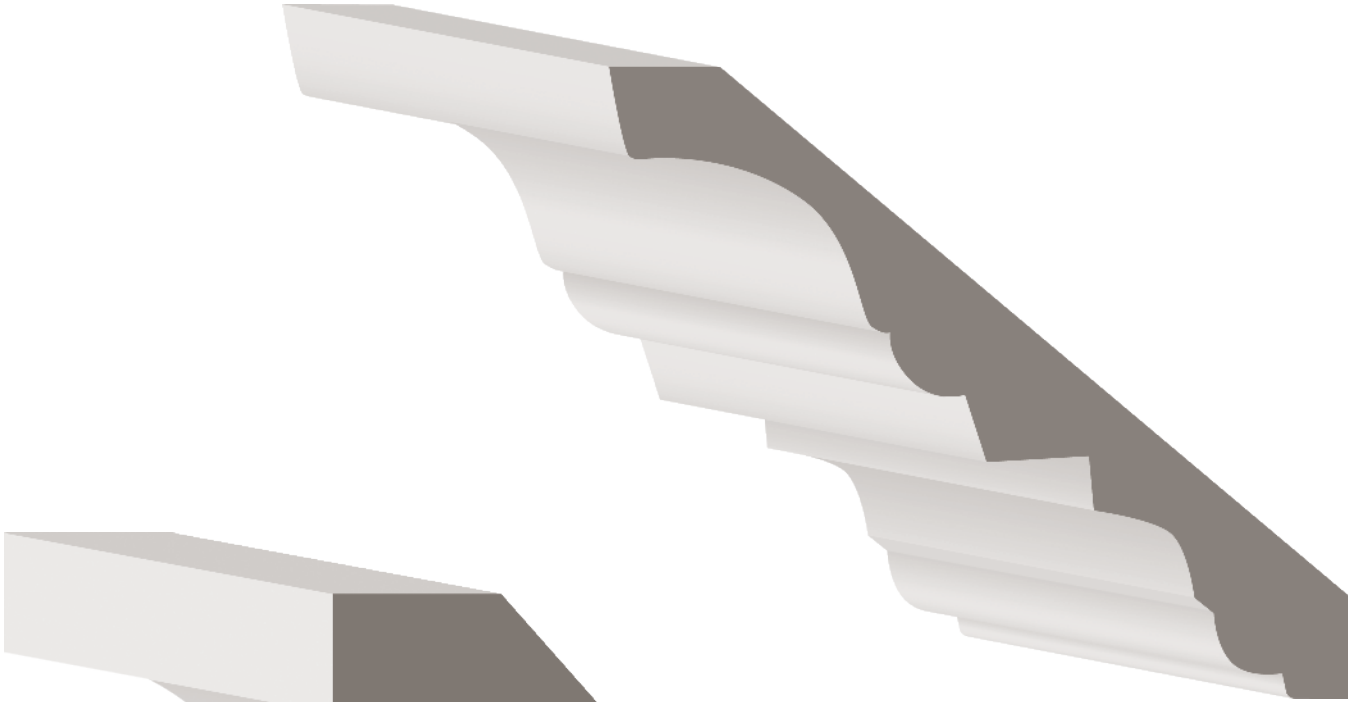

STOCK CODE



37CCM $2\frac{1}{32}'' \times 5\frac{1}{16}'' \times 16'$
(1394475)

DIMENSIONS

MDF/UL

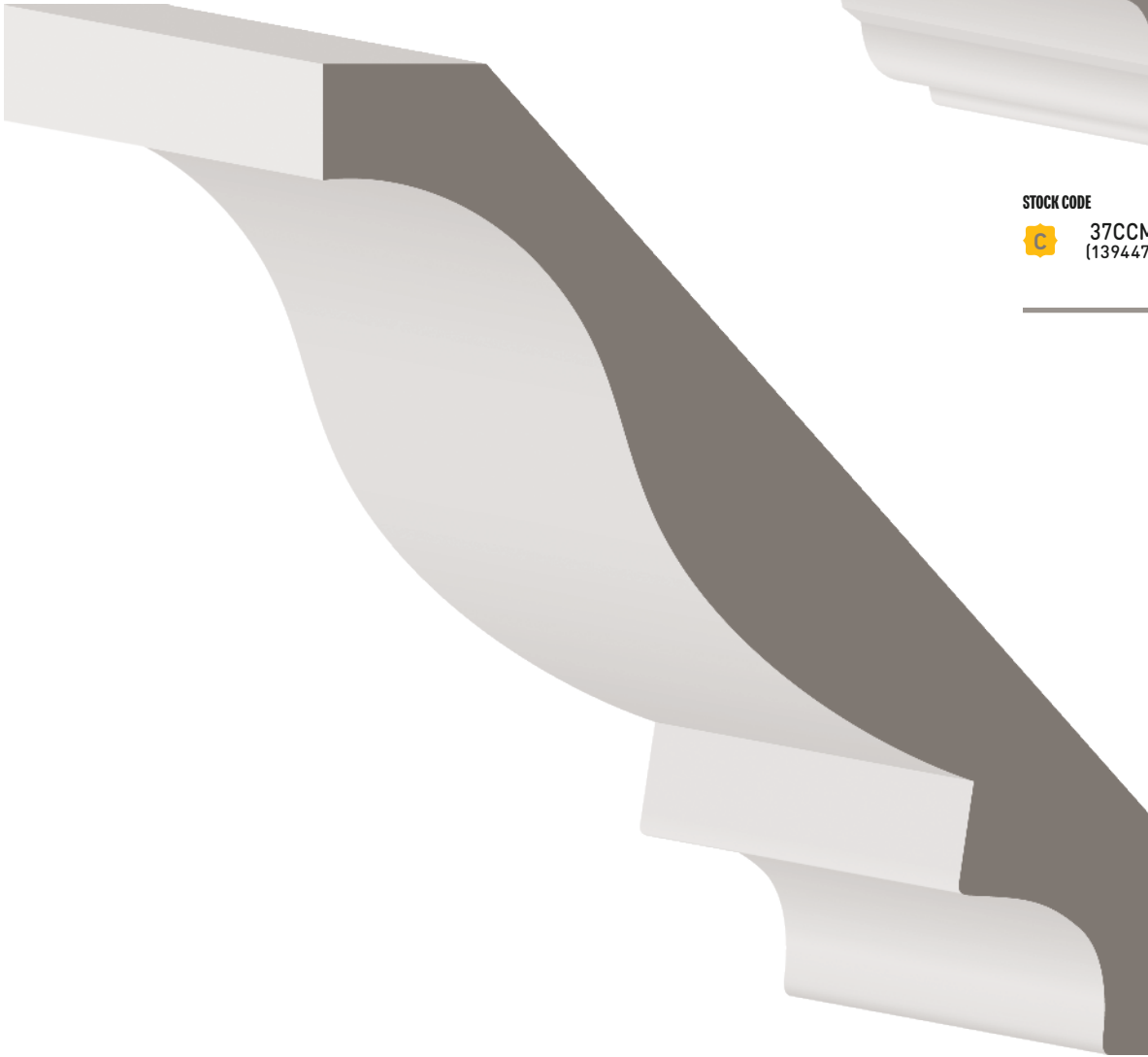

STOCK CODE



43M $1'' \times 6\frac{5}{16}'' \times 16'$
(1382827)

DIMENSIONS

MDF/UL

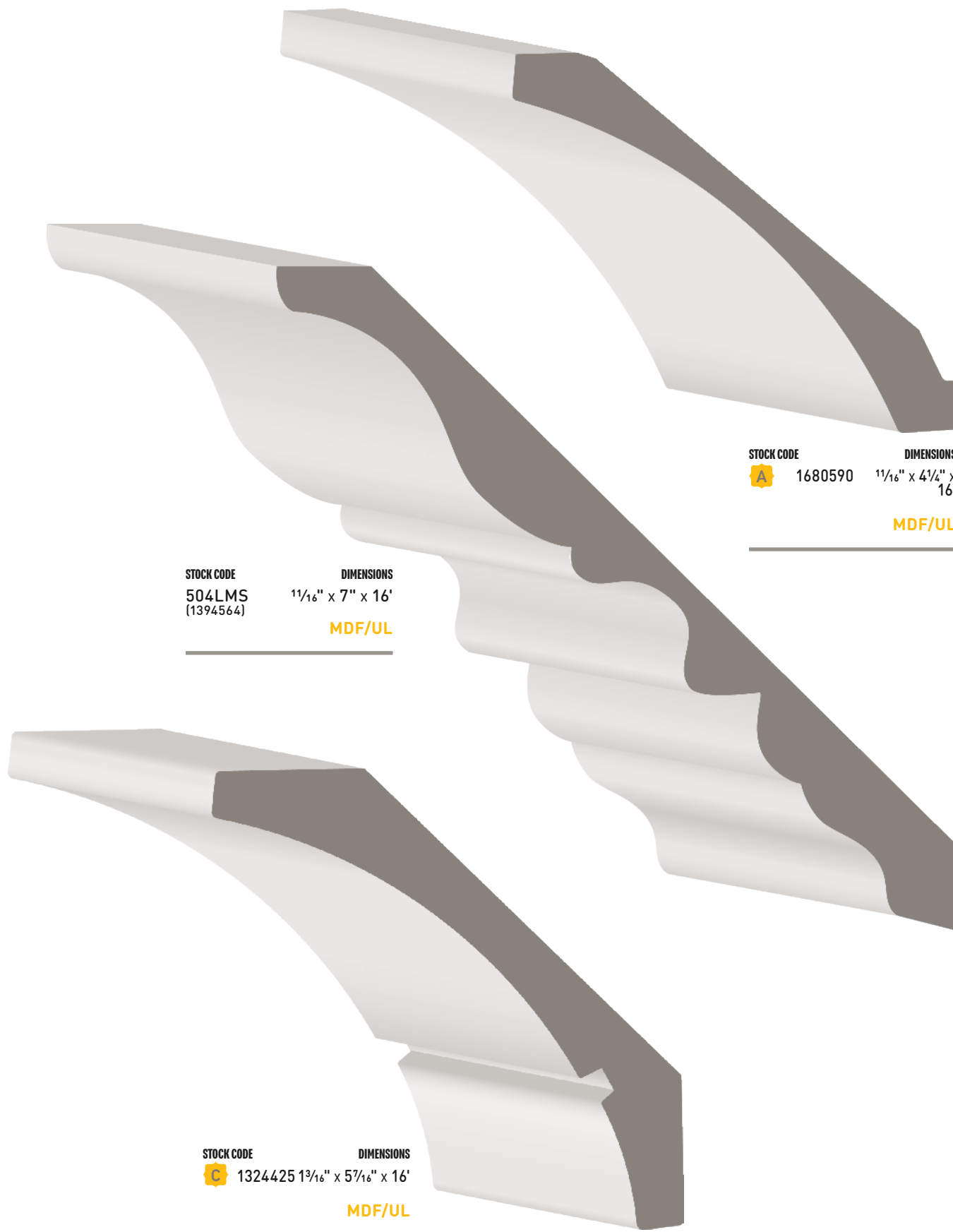

CROWNS



STOCK CODE **DIMENSIONS**
A 655M $\frac{3}{4}$ " x $5\frac{1}{4}$ " x 16'
(1394617) **MDF/UL**

STOCK CODE **DIMENSIONS**
2413M $1\frac{3}{16}$ " x $5\frac{1}{4}$ " x 16'
(1394389)
A 440M $2\frac{1}{32}$ " x $4\frac{1}{4}$ " x 16'
(1644964)
2413WM $\frac{3}{4}$ " x $7\frac{1}{4}$ " x 16'
(1662831) **MDF/UL**

A 2413P $2\frac{1}{32}$ " x $5\frac{1}{4}$ " x 16'
(1394390) **PFJ**



STOCK CODE
2153M
(1394376)

DIMENSIONS
 $\frac{3}{4}$ " x $5\frac{1}{4}$ " x 16'

MDF/UL

STOCK CODE DIMENSIONS

A 505M 1" x 7" x 16'
(1394567)

600M $2\frac{3}{32}$ " x $6\frac{3}{8}$ " x 16'
(1644965)

MDF/UL

CROWNS

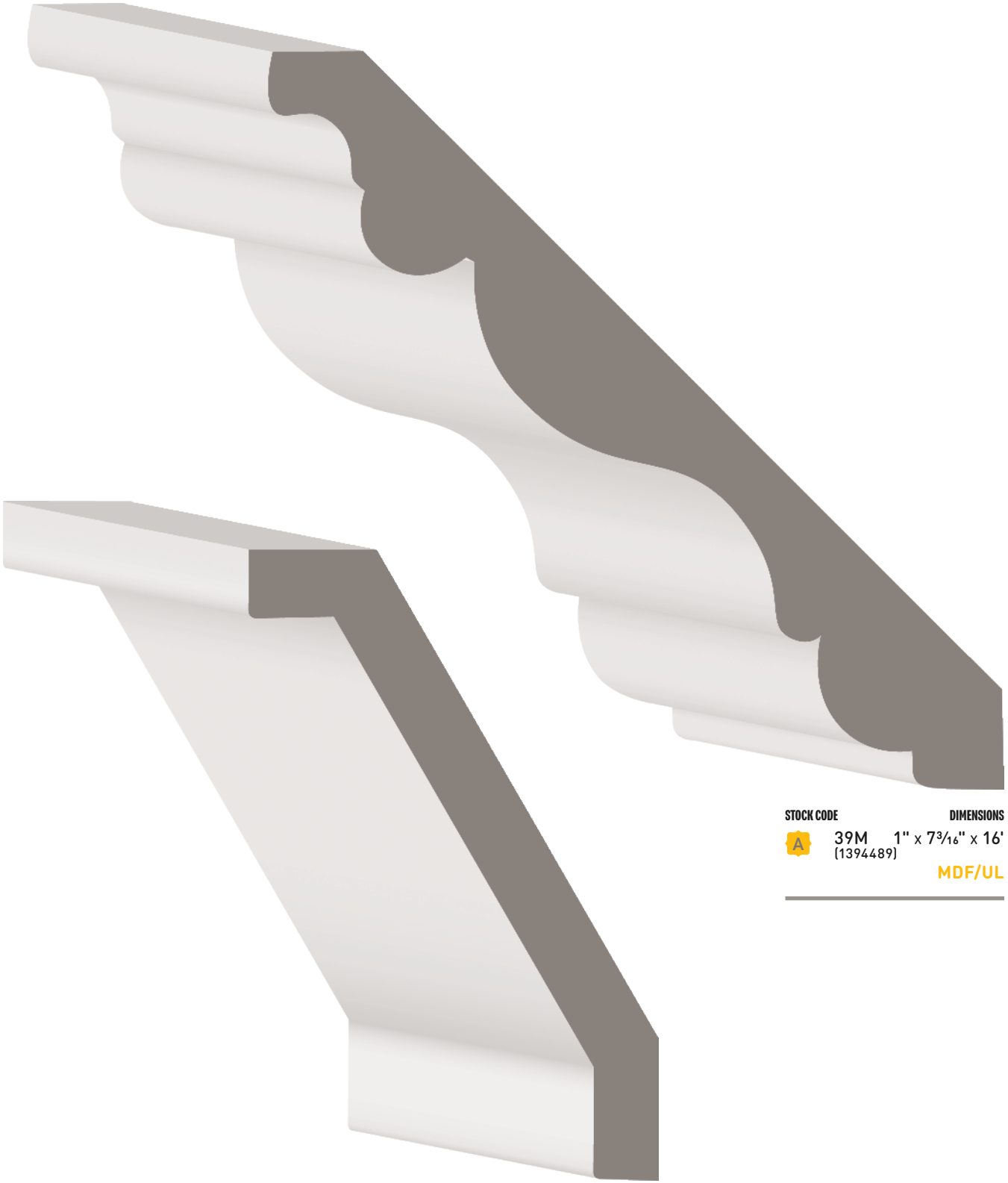

STOCK CODE
A 39M 1" x 7³/₁₆" x 16'
(1394489)
DIMENSIONS
MDF/UL

STOCK CODE
C 1675701 1" x 4¹/₄" x 16'
DIMENSIONS
MDF/UL

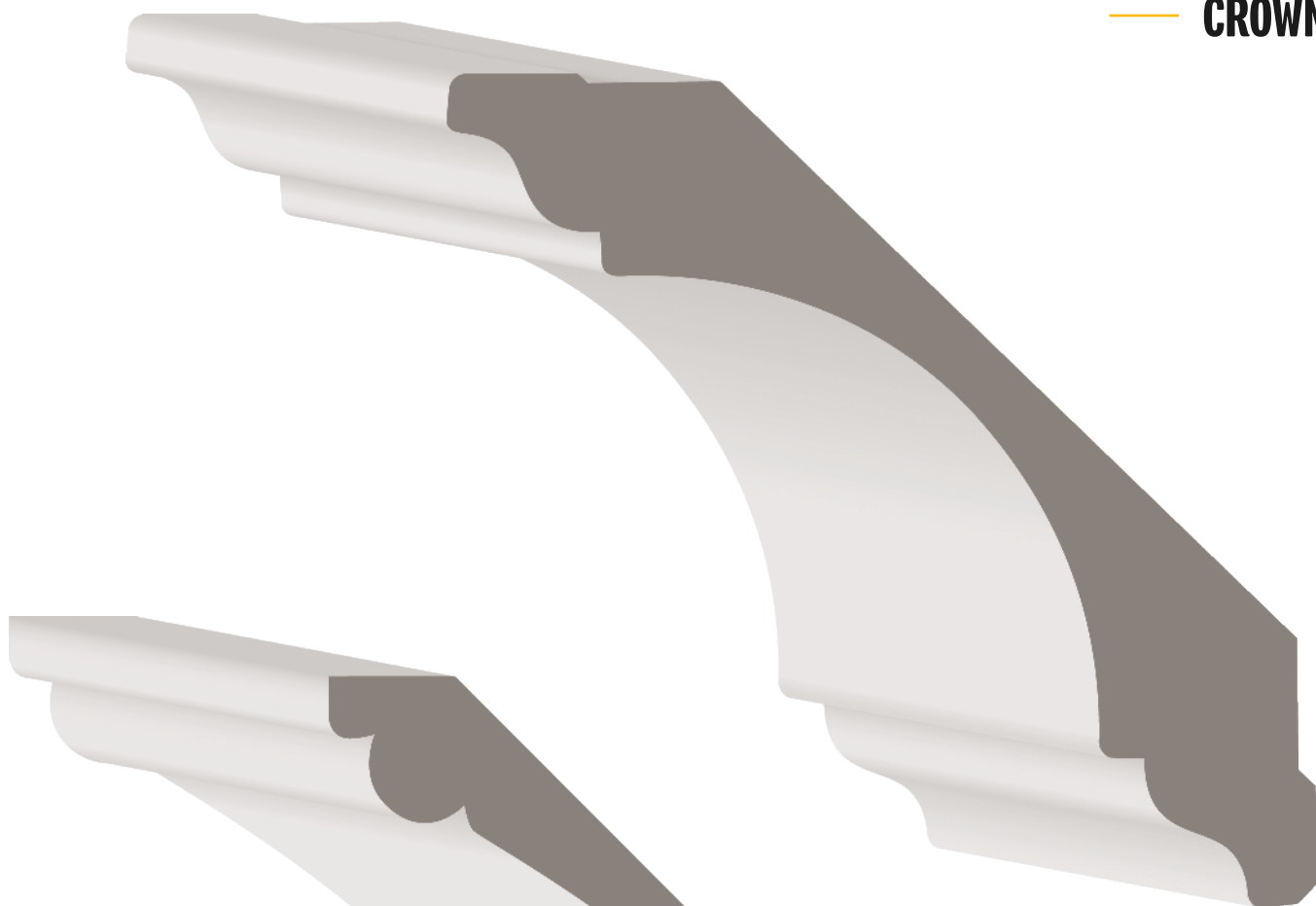

STOCK CODE	DIMENSIONS
41M (1382814)	1 ³ / ₁₆ " x 6 ⁵ / ₁₆ " x 16'
 41SM (1394496)	7 ⁷ / ₈ " x 4 ⁵ / ₁₆ " x 16'
41WM (1394497)	1 ¹ / ₈ " x 8" x 16'

MDF/UL



STOCK CODE	DIMENSIONS
675M (1394618)	3 ³ / ₄ " x 7 ¹ / ₄ " x 16'

MDF/UL

DOOR STOPS

DOOR STOPS

The door stop mouldings are attached to the door jamb on both sides and at the top. It is where the door comes to a rest when it is closed, stopping the door from moving any further and covering the gap that would otherwise appear between the door and the jambs.

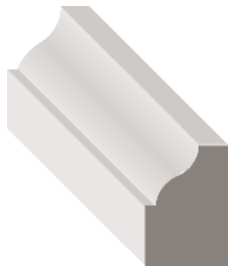

STOCK CODE
942
(1394644)

DIMENSIONS
 $\frac{3}{8}$ " x $\frac{5}{8}$ " x RL

PIN



STOCK CODE
A 876
(1394633)

DIMENSIONS
 $\frac{7}{16}$ " x $1\frac{3}{8}$ " x RL

PIN

STOCK CODE

A 1686125 $\frac{3}{8}$ " x $1\frac{3}{8}$ " x 102"

DIMENSIONS

FJR

A 887PI102 $\frac{3}{8}$ " x $1\frac{1}{4}$ " x 102"
(1394637)

A 887PF17 $\frac{3}{8}$ " x $1\frac{1}{4}$ " x 17"
(1685883)

A 1688812 $\frac{3}{8}$ " x $1\frac{1}{4}$ " x 81"

PFJ

A 886 $\frac{3}{8}$ " x $1\frac{3}{8}$ " x RL
(1462392)

A 1686930 $\frac{3}{8}$ " x $1\frac{1}{4}$ " x 85"

PIN

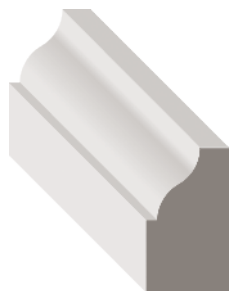

STOCK CODE
941
(1394643)

DIMENSIONS
 $\frac{3}{8}$ " x $\frac{3}{4}$ " x RL

PIN

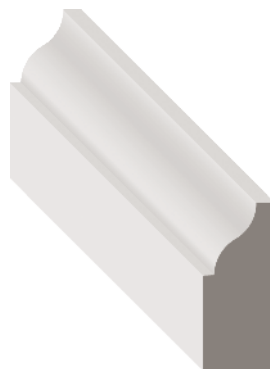

STOCK CODE
A 940FJ
(1670587)

DIMENSIONS
 $\frac{3}{8}$ " x $\frac{7}{8}$ " x 16'

FJR

940
(1394642)

$\frac{3}{8}$ " x $\frac{7}{8}$ " x RL

PIN

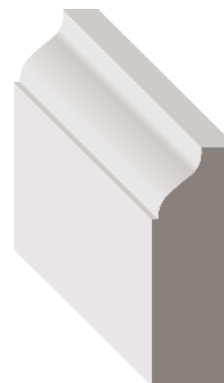

STOCK CODE
937
(1394640)

DIMENSIONS
 $\frac{3}{8}$ " x $1\frac{1}{4}$ " x RL

A 946
(1522341)

$\frac{3}{8}$ " x $1\frac{3}{8}$ " x RL

PIN



STOCK CODE
935
(1394639)

DIMENSIONS
 $\frac{3}{8}$ " x $1\frac{5}{8}$ " x RL

PIN

FLAT STOCK

Finished boards come in either S4S (Surfaced 4 Sides) or S3S (Surfaced 3 Sides) and are used for a multitude of purposes, including shelving, window ledges, base, casing, etc.

STOCK CODE	THICKNESS	HEIGHT	LENGTH	SPECIES	DESCRIPTION
249 (1394391) A	11/16"	1-1/2"	RL	PIN	Eased 4 Edges
249P (1394393)	11/16"	1-1/2"	16'	PFJ	Eased 4 Edges
1678003 C	11/16"	2-1/2"	16'	MDF/UL	Square Edges
1681158	11/16"	3-1/2"	16'	MDF/UL	Square Edges
12S4SM (1577645) C	11/16"	1-1/2"	16'	MDF/UL	Square Edges
1382501 C	11/16"	2-1/2"	85"	PFJ	Square Edges
14S4SM (1566875)	11/16"	3-1/2"	16'	MDF/UL	Square Edges
16S4SM (1511011)	11/16"	5-1/2"	16'	MDF/UL	Square Edges
18S4SM (1511014)	11/16"	7-1/4"	16'	MDF/UL	Square Edges
110S4SM (1521204)	11/16"	9-1/4"	16'	MDF/UL	Square Edges
112S4SM (1484204)	11/16"	11-1/4"	16'	MDF/UL	Square Edges
14S4SMR (1394259) A	3/4"	3-1/2"	16'	MDF/UL	Square Edges
16S4SMR (1394309) A	3/4"	5-1/2"	16'	MDF/UL	Square Edges
18S4SMR (1394345) A	3/4"	7-1/4"	16'	MDF/UL	Square Edges
110S4SMR (1394183) A	3/4"	9-1/4"	16'	MDF/UL	Square Edges
112S4SMR (1394204)	3/4"	11-1/4"	16'	MDF/UL	Square Edges
1415977 A	21/32"	3-1/2"	17'	MDF/UL	Square Edges
1484904 C	1"	3-1/2"	16'	MDF/UL	Square Edges
5410S4SP1 (1405284) C	1"	9-1/4"	16'	PFJ	Square Edges
5412S4SP1 (1405285) C	1"	11-1/4"	16'	PFJ	Square Edges
544S4SP1 (1405286) C	1"	3-1/4"	16'	PFJ	Square Edges
546S4SM (1394591)	1"	5-1/2"	16'	MDF/UL	Square Edges
546S4SP1 (1688860) C	1"	5-1/2"	16'	PFJ	Square Edges
548S4SP1 (1405290) C	1"	7-1/4"	16'	MDF/UL	Square Edges
1686516	21/32"	3-1/2"	81-1/4"	PFJ	Square Edges
1686517 A	21/32"	3-1/2"	97-1/4"	PFJ	Square Edges
94S4SP (1577740)	9/16"	3-1/2"	17'	PFJ	Square Edges
1416328	9/16"	5-1/2"	16'	PFJ	Square Edges
98S4SP (1688856) C	9/16"	7-1/4"	16'	PFJ	Square Edges
13S4SP1F17 (1662860) C	21/32"	2-1/2"	17'	PFJ	Square Edges
14S4SP1 (1382528)	21/32"	3-1/2"	16'	PFJ	Square Edges
14S4SP1F17 (1394262)	21/32"	3-1/2"	17'	PFJ	Square Edges
16S4SP1 (1394311)	21/32"	5-1/2"	16'	PFJ	Square Edges
18S4SP1 (1394347)	21/32"	7-1/4"	16'	PFJ	Square Edges
110S4SP1 (1394185)	21/32"	9-1/4"	16'	PFJ	Square Edges
112S4SP1 (1382427)	21/32"	11-1/4"	16'	PFJ	Square Edges
254 (1416042)	1/2"	3/4"	RL	PIN	Moulding
116S4SMR (1673320) C	3/4"	15-3/4"	16'	MDF/UL	Board
FF34 (1327797)	3/4"	4'	8'	MDR	Sheet Goods
FF34UL (1404783) A	3/4"	4'	8'	MDR	Sheet Goods

JAMBS

The top and two sides of a door or window frame that contact the door or sash: top jamb and side jambs. The most common size for interior use is 11/16" thick by 4-9/16" wide.

STOCK CODE	THICKNESS	WIDTH	LENGTH	SPECIES
DRJ4916P (1404762)	1-3/16"	4-9/16"	81-11/16"	PFJ
DRJ499612P (1404763)	1-3/16"	4-9/16"	97-11/16"	PFJ
DRJ699612P (1404764) A	1-3/16"	6-9/16"	97-11/16"	PFJ
FJR4981RP (1404800)	11/16"	4-9/16"	81-11/16"	FJR
FJR4981RP80 (1415480) A	11/16"	4-9/16"	97-11/16"	FJR
FJR4204FJ (1404797)	11/16"	4-9/16"	17"	FJR
FJR4204P (1382891)	11/16"	4-9/16"	17"	FJR
FJR1478P (1404793) A	11/16"	4-7/8"	16'	FJR
FJR6198P (1404803)	11/16"	6-9/16"	17"	FJR
FJR1278P (1404792)	11/16"	2-7/8"	16'	PFJ
FJP4981P (1404786) A	11/16"	4-9/16"	81-11/16"	PFJ
FJP478P80 (1404785) A	11/16"	4-7/8"	97-11/16"	PFJ
FJP6981P80 (1404789) A	11/16"	6-9/16"	97-11/16"	PFJ
FJ4981 (1404784) A	21/32"	3-1/2"	81-11/16"	PIN
1677899	1"	4"	90"	PFJ
1686536 A	11/16"	6-9/16"	81-11/16"	FJR
1686538 A	11/16"	6-9/16"	97-11/16"	FJR
1686679 A	21/32"	4-1/4"	81-11/16"	FJR
SJS48058W (1404857) A	1-1/16"	4-5/8"	81-11/16"	PIN
SJS48058WFJ (1404858)	1-1/16"	4-5/8"	81-11/16"	FJR
SJS49658WFJ (1639785)	1-1/16"	4-5/8"	97-11/16"	FJR
SJS68058WFJ (1644970) A	1-1/16"	6-9/16"	81-11/16"	FJR
SJS48058WP (1404859)	1-1/16"	4-5/8"	81-11/16"	PFJ
SJS49658WP (1426537)	1-1/16"	4-5/8"	97-11/16"	PFJ
SJS68058P (1393408)	1-1/16"	6-9/16"	81-11/16"	PFJ
SJS69658P (1404868)	1-1/16"	6-9/16"	97-11/16"	PFJ

MULLIONS

The upright or vertical member dividing the panels in a door. A mullion is also the vertical member of a sash, window or door frame between openings in a multiple opening frame.

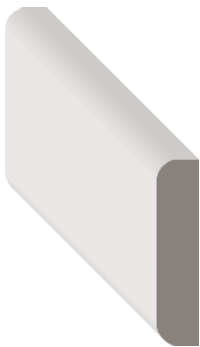

STOCK CODE
A 969 $\frac{7}{32}$ " x $3\frac{1}{32}$ " x RL
 (1394653)
PIN



STOCK CODE
A 970 $\frac{7}{32}$ " x $1\frac{5}{32}$ " x RL
 (1394654)
PIN



STOCK CODE
A 972 $\frac{3}{8}$ " x 2" x RL
 (1462450)
PIN



STOCK CODE
C 989LFJ $\frac{3}{8}$ " x $1\frac{1}{8}$ " x 16'
 (1394666)
FJR

C 989L $\frac{3}{8}$ " x $1\frac{1}{8}$ " x RL
 (1394665)
MDF/UL

A 987L $\frac{3}{8}$ " x $1\frac{3}{8}$ " x RL
 (1394662)

988L $\frac{3}{8}$ " x $1\frac{1}{2}$ " x RL
 (1394663)

C 987 $\frac{3}{8}$ " x 2" x RL
 (1394661)
PIN

PANEL MOULDS

The use of panel or picture moulding can be an effective and inexpensive way to frame wall paneling, paper or fabric, and add interest to walls.

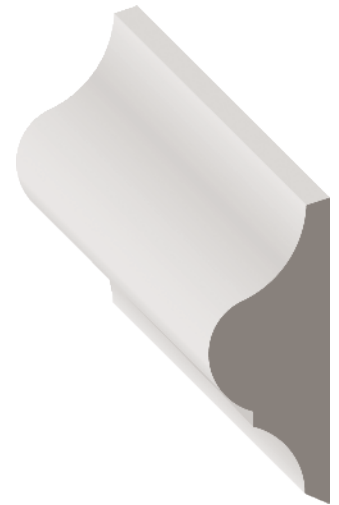

STOCK CODE
A 730P $\frac{5}{8}$ " x $1\frac{1}{32}$ " x 16'
 (1394624)
DIMENSIONS
PFJ

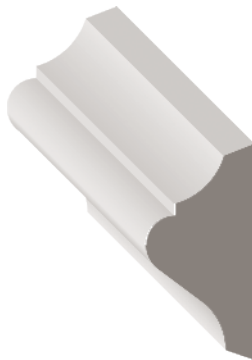

STOCK CODE
 183
 (1382608)
DIMENSIONS
 $\frac{1}{16}$ " x $1\frac{1}{8}$ " x RL
PIN

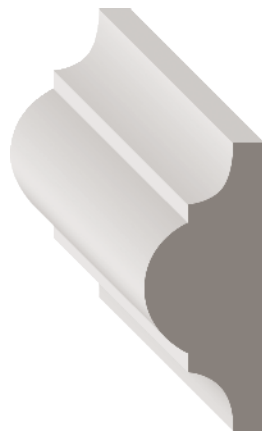

STOCK CODE
A 153P $\frac{5}{8}$ " x $1\frac{1}{2}$ " x 16'
 (1394275)
DIMENSIONS
PFJ



STOCK CODE
A 1217 $\frac{1}{2}$ " x $1\frac{7}{16}$ " x RL
 (1394228)
DIMENSIONS
PIN

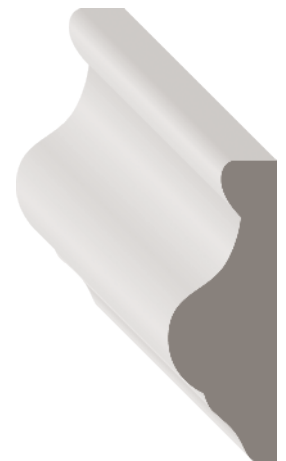

STOCK CODE
A 05M $\frac{3}{16}$ " x $1\frac{1}{16}$ " x 16'
 (1394150)
DIMENSIONS
MDF/UL

PANEL MOULDS



STOCK CODE
1692573

DIMENSIONS
1 1/32" x" x 1 1/4" x 16'

PFJ



STOCK CODE
42PR
(1394501)

DIMENSIONS
1 1/16" x 1 1/16" x 16'

PFJ

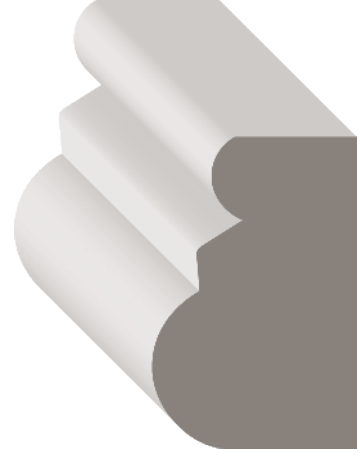

STOCK CODE
42P
(1394500)

DIMENSIONS
1 1/16" x 1 1/16" x 16'

PFJ

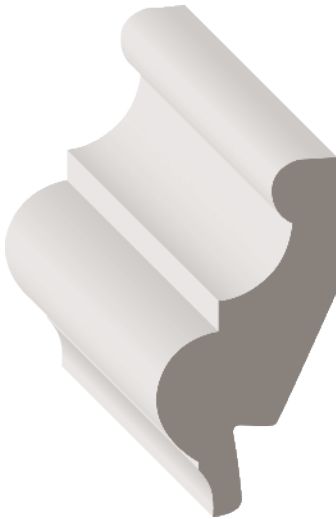

STOCK CODE
A 185
(1394334)

DIMENSIONS
1 5/16" x 1 7/8" x RL

PIN



STOCK CODE
1692578

DIMENSIONS
3/16" x 2" x 16'

PFJ

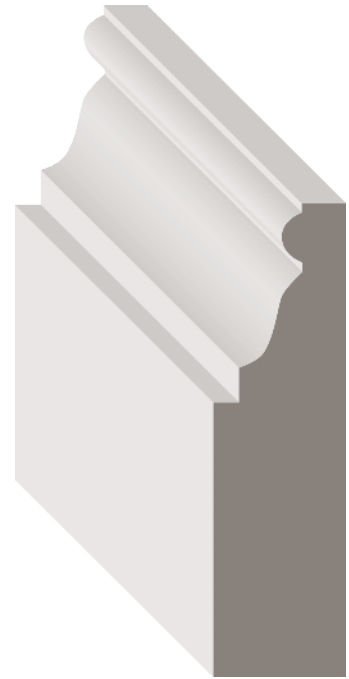

STOCK CODE
A 02FJ
(1394147)

DIMENSIONS
5/8" x 2 1/2" x 16'

MDF/UL

02P
(1394149)

1 1/16" x 2 7/16" x 16'

PFJ

STOOLS

A trim or casing applied immediately below the window sill.

STOOLS



STOCK CODE
1021P
(1577734)

DIMENSIONS
1¹/₁₆" x 5¹/₄" x 16'

STOCK CODE
1021WP
(1577736)

DIMENSIONS
1¹/₁₆" x 7¹/₄" x 16'

PFJ

STOCK CODE
1021FJ
(1567235)

DIMENSIONS
1¹/₁₆" x 5¹/₄" x 16'

STOCK CODE
MRFJ1021714
(1577819)

DIMENSIONS
1¹/₁₆" x 7¹/₄" x 16'

FJR

STOCK CODE
1021WM
(1394161)

DIMENSIONS
1¹/₁₆" x 7¹/₄" x 16'

STOCK CODE
1021M
(1382351)

DIMENSIONS
3¹/₁₆" x 5¹/₄" x 16'

MDF/UL



STOCK CODE
1022M
(1382355)

DIMENSIONS
3¹/₁₆" x 4¹/₂" x 16'

MDF/UL

STOCK CODE
1022BNP
(1394164)

DIMENSIONS
1¹/₁₆" x 15¹/₈" x 16'

PFJ

STOCK CODE
1195FJ
(1394225)

DIMENSIONS
1¹/₁₆" x 2⁷/₁₆" x 16'

FJR

STOCK CODE
1195P
(1394226)

DIMENSIONS
1¹/₁₆" x 2⁷/₁₆" x 16'

PIN



STOCK CODE
1163P
(1382440)

DIMENSIONS
1¹/₁₆" x 3¹/₄" x 16'

PFJ

STOCK CODE
11630D
(1394218)

DIMENSIONS
1¹/₁₆" x 3¹/₄" x 16'

PIN



STOCK CODE
1164P
(1382443)

DIMENSIONS
1¹/₁₆" x 2³/₄" x 16'

PFJ

MISCELLANEOUS

ASTRAGALS

An astragal is commonly used to seal between a pair of doors. The astragal closes the clearance gap. The vertical moulding attaches to a stile on one of a pair of doors against which the other door strikes or closes.

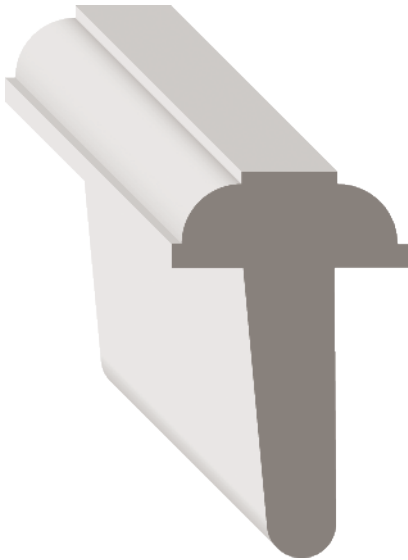

STOCK CODE
C 1305PF07 1 1/4" x 2" x 7'
 (1382486) **PFJ**

BED MOULDS

Similar to crown moulding, used to cover the joint between the ceiling and wall. Can be either sprung or plain, or flush to the wall as an extension of a cornice mould.

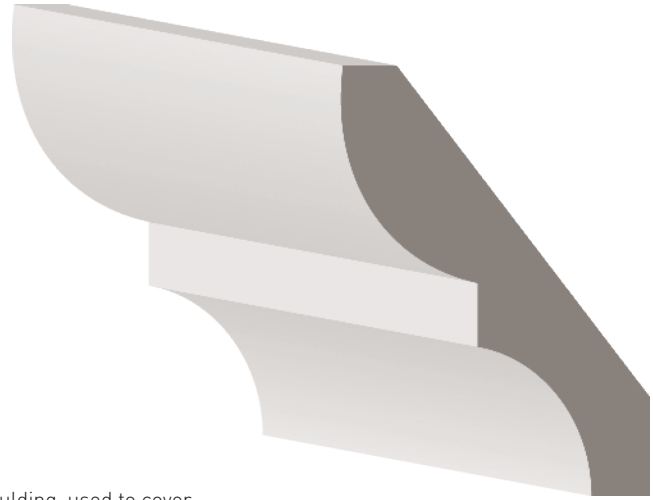

STOCK CODE
C 70 3/16" x 2 3/4" x RL
 (1462304) **PIN**



STOCK CODE
C 75FJ 3/16" x 1 5/8" x 16'
 (1394628) **FJR**

A 75P 3/16" x 1 5/8" x 16'
 (1382995) **PFJ**

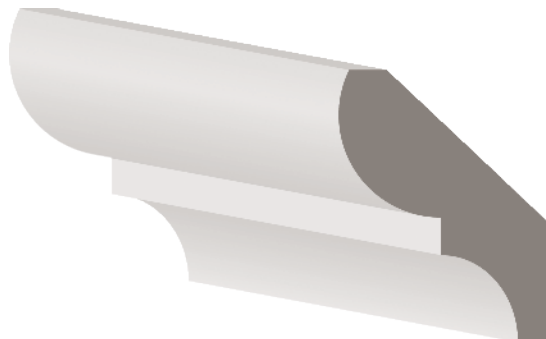

STOCK CODE
 74P 3/16" x 1 3/4" x 16'
 (1394626) **PFJ**

BRICK MOULDS

A brick mould is mainly used as exterior casing around doors. The most common size is 2"; however, 1-1/2" and 1-1/4" sizes are available. Brick moulds can also be used in place of a crown and as a transition under window sills.

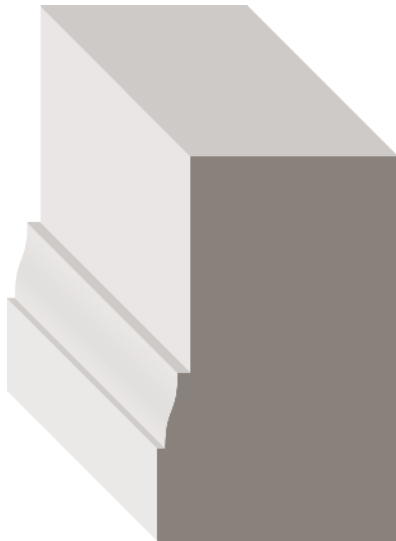

STOCK CODE	DIMENSIONS
180P (1382605)	1 1/4" x 2" x 17'
180P185 (1394330)	1 1/4" x 2" x 85"

PFJ

180 (1382603)	1 1/4" x 2" x RL
------------------	------------------

PIN

180PVCF18 (1382607)	1 1/4" x 2" x 18'
------------------------	-------------------

PVC



STOCK CODE	DIMENSIONS
A 995 (1416339)	3/4" x 3/4" x RL

PIN

CHAMFER STRIP

Utilized where kitchen cabinet tops meet the walls or as a linoleum cove. Sometimes used for window applications.

CORNER GUARDS

Corner guards are used to protect the outside edges of the wall from damage and abrasion. Corner guards come in a wide variety of sizes and detailing.



STOCK CODE	DIMENSIONS
C 206L (1484580)	1 1/16" x 1 1/16" x RL
A 206LF16 (1639733)	1 1/16" x 1 1/16" x 16'

PIN



STOCK CODE	DIMENSIONS
205 (1394363)	1 1/8" x 1 1/8" x RL
A 205F08 (1394364)	1 1/8" x 1 1/8" x 8'
A 205F16 (1394365)	1 1/8" x 1 1/8" x 16'

PIN

MISCELLANEOUS

COVES

Coves are commonly used to soften the transition on inside corners but may be used for a wide range of applications.

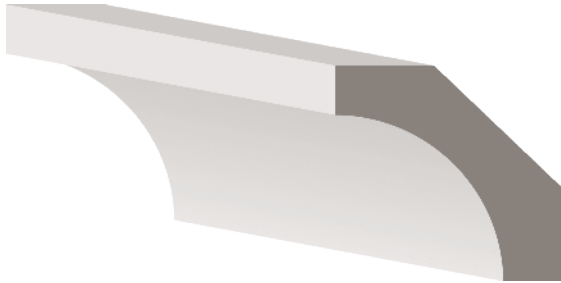

STOCK CODE	DIMENSIONS
A 86 (1394632)	$\frac{3}{16}$ " x $1\frac{5}{8}$ " x RL
PIN	



STOCK CODE	DIMENSIONS
A 1461743	$1\frac{1}{4}$ " x $1\frac{1}{8}$ " x 17'
PFJ	

1000 (1626643)	$1\frac{1}{16}$ " x $1\frac{1}{16}$ " x RL
O	

100 (1394151)	$1\frac{1}{16}$ " x $1\frac{1}{16}$ " x RL
-------------------------	--

A 100F08 (1382341)	$1\frac{1}{16}$ " x $1\frac{1}{16}$ " x 8'
------------------------------	--

A 100F16 (1394153)	$1\frac{1}{16}$ " x $1\frac{1}{16}$ " x 16'
------------------------------	---

C 101 (1484114)	$\frac{1}{2}$ " x $\frac{1}{2}$ " x RL
PIN	

FULL ROUNDS

Full rounds are used for numerous purposes and projects. Some of the more common uses are closet poles, curtain rods and towel rods.

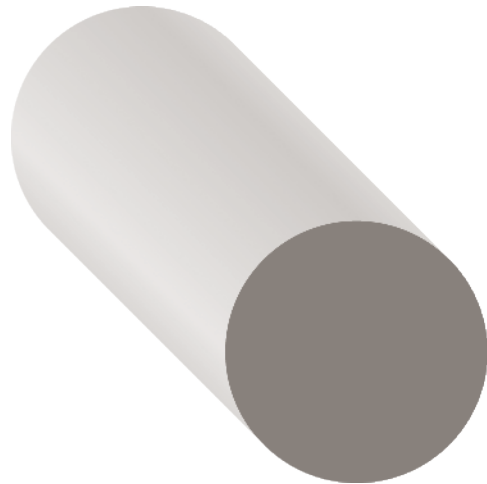

STOCK CODE	DIMENSIONS
233 (1685962)	$1\frac{1}{4}$ " x $1\frac{1}{4}$ " x 17'
PIN	

HANDRAILS

Handrails provide safety and support.

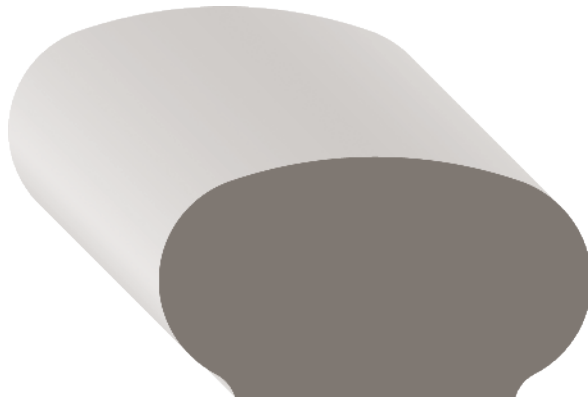

STOCK CODE	DIMENSIONS
240P (1382676)	1 1/4" x 2 1/4" x 17'
	PFJ

240F16 (1394386)	1 1/4" x 2 1/4" x 16'
	PIN

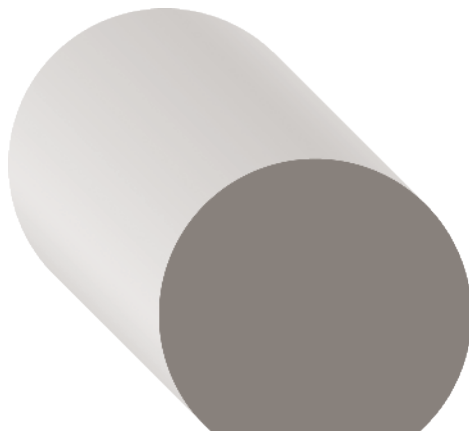

STOCK CODE	DIMENSIONS
C 231F16 (1394379)	1 1/16" x 1 5/8" x 16'
	PIN

LATTICE

A thin strip of flat moulding commonly used to hide seams and edges.

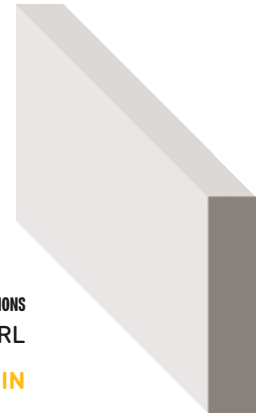

STOCK CODE	DIMENSIONS
266 (1382686)	1/4" x 1 1/2" x RL
	PIN

268SP (1394397)	1/4" x 1 1/8" x 16'
	PIN-PRIMED

PICTURE MOULD

A narrow moulding along the perimeter of the walls near the ceiling line traditionally used to support hooks for picture hanging.

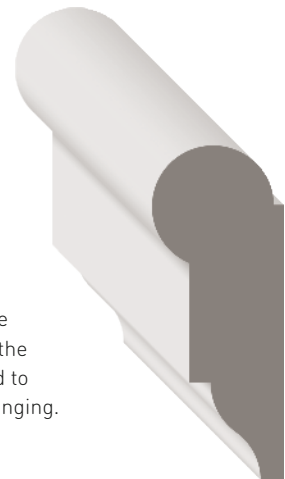

STOCK CODE	DIMENSIONS
A 273FJ (1394399)	1 1/16" x 1 3/4" x 16'
	FJR

273P (1394400)	1 1/16" x 1 3/4" x 16'
	PFJ

C 273 (1394398)	1 1/16" x 1 3/4" x RL
	PIN

MISCELLANEOUS

QUARTER ROUNDS

Quarter rounds come in several sizes and serve a variety of functions. They are most often used with baseboards.



STOCK CODE
103
(1382357)

DIMENSIONS
1 1/16" x 1 1/16" x 16'

PIN



STOCK CODE

DIMENSIONS

A 1382369 1 1/16" x 1 1/16" x 8'

1382368 1 1/16" x 1 1/16" x 16'

PFJ

1682398 1 1/16" x 1 1/16" x 16'

LVL

1050 3/4" x 3/4" x RL
(1394169)

O

C 105 3/4" x 3/4" x RL
(1382360)

106 1 1/16" x 1 1/16" x RL
(1461763)

PIN

C 108 1/2" x 1/2" x 16'
(1394174)

PIN

RAKE MOULDS

Raked moulds are moulding that are required when two planes or surfaces meet each other at angles other than horizontal and vertical such as in raked ceiling.



STOCK CODE

DIMENSIONS

210P 1 1/16" x 1 5/8" x 16'
(1382653)

PFJ



STOCK CODE

DIMENSIONS

C 212P 1 1/16" x 2 1/2" x 16'
(1394374)

PFJ

SASH BEADS

Narrow wood strips or moulding used for edging against a door or window sash, or to secure glass panels to doors and windows.

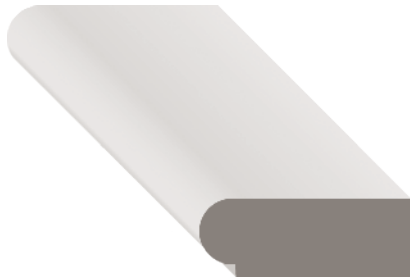

STOCK CODE
953P
(1394647)

DIMENSIONS
 $\frac{7}{16}$ " x $1\frac{1}{8}$ " x 16'

PFJ



STOCK CODE
150P
(1394274)

DIMENSIONS
 $\frac{1}{2}$ " x $1\frac{1}{2}$ " x 16'

PFJ

SQUARE

Squares are used in the framing of shelves and cabinets, or are used to build up other profiles. Its uses are mostly utilitarian.



STOCK CODE
A 239P
(1394384)

DIMENSIONS
 $\frac{3}{4}$ " x $\frac{3}{4}$ " x 8'

PFJ

SHELVING

Flat boards suitable for a variety of uses, including organizational storage in closets, pantries and more.



STOCK CODE
C 1681259

DIMENSIONS
 $\frac{3}{4}$ " x $17\frac{1}{4}$ " x 16'

MDF/UL

SHIPLAPS

A wall paneling treatment made from wide wooden boards installed horizontally to create a rustic, cottage or coastal look.



STOCK CODE
C 1687158

DIMENSIONS
 $\frac{17}{32}$ " x $5\frac{3}{8}$ " x 16'

1687159 $1\frac{7}{32}$ " x $7\frac{3}{8}$ " x 16'

PFJ

1683077 $\frac{1}{2}$ " x $5\frac{1}{4}$ " x 16'

1678737 $\frac{1}{2}$ " x $7\frac{1}{4}$ " x 16'

MDF/UL

MISCELLANEOUS

SCREEN MOULDS

A very versatile profile; screen mould fits a wide variety of needs and uses. Traditionally used to hold mesh screening into wood screens, it also works well as edge trim on various shelving or wood trim for wallpaper.



STOCK CODE
142
(1415968)

DIMENSIONS
1/4" x 3/4" x RL

PIN

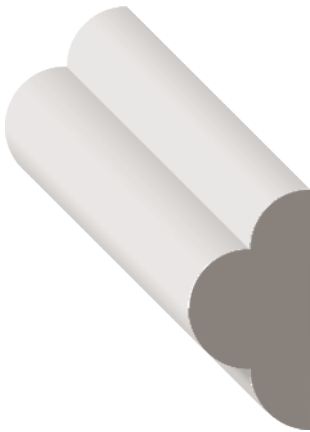

STOCK CODE
137P
(1394247)

DIMENSIONS
1/2" x 1 1/4" x 16'

PIN

TONGUE & GROOVE PANELING

Panels used to decorate or cover a wall, fitted together edge to edge using a slot and ridge on the opposite edge.



STOCK CODE
C 1686323 2 1/32" x 5 1/4" x 16'

PFJ

A 1676081 1 1/16" x 5 1/4" x 16'

A 1676082 1 1/16" x 7 1/4" x 16'

MDF/UL

STOCK CODE
A 16YP2VJREV 1 1/16" x 5 1/2" x RL
(1394324)

PIN

WAINSCOT CAPS

A wainscot cap is used to finish the top edge of a wainscot wall treatment. It may also be used as one component of a larger chair rail profile.

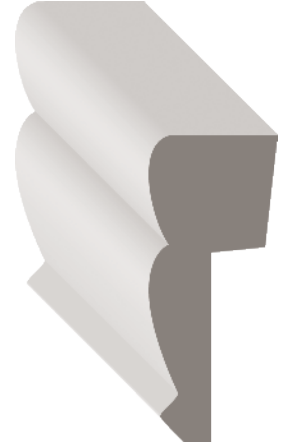

STOCK CODE
A 1219 1 1/16" x 1 5/8" x RL
(1394229)

PIN

INDEX

STOCK CODE	PROFILE TYPE	DIMENSIONS	SPECIES	PAGE
1324425	Crown	1-3/16" x 5-7/16" x 16'	MDF/UL	39
1328541	Crown	1-3/16" x 5-1/4" x 16'	MDF/UL	37
1328544	Crown	1-3/16" x 6-3/4" x 16'	MDF/UL	37
1382368	Quarter Round	1 1/16" x 1 1/16" x 16'	PFJ	54
1382369	Quarter Round	1 1/16" x 1 1/16" x 8'	PFJ	54
1382479	Baseboard Shoe	7/16" x 1 1/16" x 16'	PFJ	17
1382811	Casing	1 1/16" x 3-1/2" x 16'	PFJ	20
1382822	Baseboard	9/16" x 3-1/2" x 16'	PFJ	15
1382857	Casing	1 1/16" x 2-1/2" x 16'	PFJ	20
1392989	Baseboard	9/16" x 5-1/4" x 16'	PFJ	11
1393458	Baseboard	9/16" x 5-1/2" x 16'	PFJ	15
1394337	Baseboard	9/16" x 7-1/4" x 16'	MDF/UL	10
1394548	Casing	1 1/16" x 4-1/4" x 17'	PIN	29
1394549	Casing	1-1/16" x 4-1/4" x 17'	PIN	30
1394591	Flat Stock	1" x 5-1/2" x 16'	MDF/UL	45
1461743	Cove	1 1/16" x 1 1/16" x 17'	PFJ	52
1462168	Baseboard	9/16" x 4-1/4" x 16'	PFJ	13
1484991	Casing	1" x 3-1/4" x 16'	PFJ	19
1521266	Baseboard Shoe	1/2" x 3/4" x 16'	PFJ	17
1674183	Back Band	1 1/16" x 1-1/16" x 17'	FJR	7
1674680	Back Band	1-5/16" x 1-5/16" x 17'	PFJ	8
1675701	Crown	1" x 4-1/4" x 16'	MDF/UL	42
1676081	T & G Paneling	1 1/16" x 5-1/4" x 16'	MDF/UL	56
1676082	T & G Paneling	1 1/16" x 7-1/4" x 16'	MDF/UL	56
1677899	Jamb	1" x 4" x 90"	PFJ	45
1677973	Casing	5/8" x 3-1/4" x 17'	MDF/UL	25
1678737	Shiplap	1/2" x 7-1/4" x 16'	MDF/UL	55
1678975	Casing	29/32" x 3-7/32" x 103"	PFJ	26
1680231	Baseboard	9/16" x 5-1/2" x 16'	PFJ	14
1680232	Baseboard	9/16" x 7-1/4" x 16'	PFJ	14
1680590	Crown	1 1/16" x 4-1/4" x 16'	MDF/UL	39
1680633	Casing	1-1/16" x 3-11/16" x 17'	PFJ	25
1681259	Shelving	3/4" x 17-1/4" x 16'	MDF/UL	55
1681669	Baseboard	1/2" x 7-1/4" x 16'	MDF/UL	11
1682127	Baseboard Shoe	1/2" x 3/4" x 16'	LVL	17
1682398	Quarter Round	1 1/16" x 1 1/16" x 16'	LVL	54
1682984	Casing	3/4" x 3-1/2" x 17'	MDF/UL	24
1683077	Shiplap	1/2" x 5-1/4" x 16'	MDF/UL	55
1683696	Casing	1 1/16" x 3-1/2" x 17'	PFJ	24
1684003	Back Band	1 1/16" x 1-1/16" x 16'	PFJ	7
1685927	Casing	1 1/16" x 2-15/16" x 17'	FJR	23
1686125	Door Stop	3/8" x 1-3/8" x 102"	FJR	44
1686323	T & G Paneling	21/32" x 5-1/4" x 16'	PFJ	56
1686891	Back Band	1 1/16" x 1-1/16" x 17'	PFJ	7
1686930	Door Stop	3/8" x 1-1/4" x 85"	PIN	44
1687158	Shiplap	17/32" x 5-3/8" x 16'	PFJ	55
1687159	Shiplap	17/32" x 7-3/8" x 16'	PFJ	55

STOCK CODE	PROFILE TYPE	DIMENSIONS	SPECIES	PAGE
1688812	Door Stop	3/8" x 1-1/4" x 81"	PFJ	44
1692568	Baseboard	9/16" x 5-1/4" x 16'	PFJ	14
1692569	Baseboard	9/16" x 7-1/4" x 16'	PFJ	14
1692570	Casing	1 1/16" x 2-3/4" x 17'	PFJ	24
1692571	Casing	1 1/16" x 3-1/2" x 17'	PFJ	24
1692572	Chair Rail	9/16" x 3" x 16'	PFJ	32
1692573	Panel Mould	1 1/32" x 1-1/4" x 16'	PIN	48
1692574	Baseboard	9/16" x 4-1/4" x 16'	PFJ	12
1692575	Casing	1 1/16" x 2-3/4" x 17'	MDF/UL	20
1692576	Baseboard	9/16" x 5-1/4" x 16'	PFJ	12
1692577	Casing	1 1/16" x 3-1/4" x 17'	MDF/UL	20
1692578	Panel Mould	9/16" x 2" x 16'	PFJ	48
1692981	Casing	1 1/16" x 3-1/2" x 102"	PFJ	21
1693026	Casing	1 1/16" x 3-1/2" x 84-13/16"	PFJ	20
1693027	Casing	1 1/16" x 2-1/2" x 83-3/4"	PFJ	20
1693028	Casing	1 1/16" x 2-1/4" x 83-1/2"	PFJ	23
45 [1394522]	Crown	9/16" x 5-1/4" x RL	PIN	37
51 [1394568]	Crown	9/16" x 3-1/4" x 16'	PIN	35
52 [1416201]	Crown	9/16" x 2-3/4" x RL	PIN	34
60 [1394596]	Crown	9/16" x 1-3/4" x RL	PIN	35
70 [1462304]	Bed Mould	9/16" x 2-3/4" x RL	PIN	50
86 [1394632]	Cove	9/16" x 1-5/8" x RL	PIN	52
100 [1394151]	Cove	1 1/16" x 1 1/16" x RL	PIN	52
101 [1484114]	Cove	1/2" x 1/2" x RL	PIN	52
103 [1382357]	Quarter Round	1-1/16" x 1-1/16" x 16'	PIN	54
105 [1382360]	Quarter Round	3/4" x 3/4" x RL	PIN	54
106 [1461763]	Quarter Round	1 1/16" x 1 1/16" x RL	PIN	54
108 [1394174]	Quarter Round	1/2" x 1/2" x 16'	PIN	54
126 [1461861]	Baseboard Shoe	1/2" x 3/4" x RL	PIN	17
129 [1394238]	Baseboard Shoe	7/16" x 1 1/16" x RL	PIN	17
131 [1472771]	Baseboard Shoe	1/2" x 3/4" x RL	PIN	17
142 [1415968]	Screen Mould	1/4" x 3/4" x RL	PIN	56
163 [1394276]	Baseboard Cap	1 1/16" x 1-3/8" x RL	PIN	16
166 [1382563]	Baseboard Cap	5/8" x 1-1/4" x 16'	PIN	16
172 [1394325]	Baseboard Cap	5/8" x 3/4" x RL	PIN	16
180 [1382603]	Brick Mould	1-1/4" x 2" x RL	PIN	51
183 [1382608]	Panel Mould	9/16" x 1-1/8" x RL	PIN	47
185 [1394334]	Panel Mould	15/16" x 1-7/8" x RL	PIN	48
205 [1394363]	Corner Guard	1-1/8" x 1-1/8" x RL	PIN	51
233 [1685962]	Full Round	1-1/4" x 1-1/4" x 17'	PIN	52
249 [1394391]	Flat Stock	1 1/16" x 1-1/2" x RL	PIN	45
254 [1416042]	Flat Stock	1/2" x 3/4" x RL	PIN	45
266 [1382686]	Lattice	1/4" x 1-1/2" x RL	PIN	53
273 [1394398]	Picture Mould	1 1/16" x 1-3/4" x RL	PIN	53
280 [1382696]	Back Band	1 1/16" x 1-1/16" x RL	PIN	7
281 [1394402]	Back Band	1 1/16" x 1-1/16" x RL	PIN	7
324 [1521753]	Casing	1 1/16" x 2-1/4" x RL	PIN	18

STOCK CODE	PROFILE TYPE	DIMENSIONS	SPECIES	PAGE
327 (1382723)	Casing	1 ¹ / ₁₆ " x 2-1 ¹ / ₄ " x RL	PIN	18
356 (1462115)	Casing	2 ¹ / ₃₂ " x 2-1 ¹ / ₄ " x RL	PIN	21
366 (1382766)	Casing	1 ¹ / ₁₆ " x 2-1 ¹ / ₄ " x RL	PIN	19
387 (1394477)	Casing	5 ⁵ / ₈ " x 2-1 ¹ / ₄ " x RL	PIN	18
399 (1644963)	Casing	1 ⁵ / ₁₆ " x 3-1 ¹ / ₄ " x RL	PIN	26
623 (1382942)	Baseboard	9 ⁹ / ₁₆ " x 3-1 ¹ / ₄ " x RL	PIN	9
713 (1382972)	Baseboard	9 ⁹ / ₁₆ " x 3-1 ¹ / ₄ " x RL	PIN	12
876 (1394633)	Door Stop	7 ⁷ / ₁₆ " x 1-3 ³ / ₈ " x RL	PIN	44
886 (1462392)	Door Stop	3 ³ / ₈ " x 1-3 ³ / ₈ " x RL	PIN	46
935 (1394639)	Door Stop	3 ³ / ₈ " x 1-5 ⁵ / ₈ " x RL	PIN	44
937 (1394640)	Door Stop	3 ³ / ₈ " x 1-1 ¹ / ₄ " x RL	PIN	44
940 (1394642)	Door Stop	3 ³ / ₈ " x 7 ⁷ / ₈ " x RL	PIN	44
941 (1394643)	Door Stop	3 ³ / ₈ " x 3 ³ / ₄ " x RL	PIN	44
942 (1394644)	Door Stop	3 ³ / ₈ " x 5 ⁵ / ₈ " x RL	PIN	44
946 (1522341)	Door Stop	3 ³ / ₈ " x 1-3 ³ / ₈ " x RL	PIN	44
969 (1394653)	Mullion	7 ⁷ / ₃₂ " x 3 ³ / ₁₆ " x RL	PIN	46
970 (1394654)	Mullion	7 ⁷ / ₃₂ " x 1-1 ¹ / ₃₂ " x RL	PIN	46
972 (1462450)	Mullion	3 ³ / ₈ " x 2" x RL	PIN	46
987 (1394661)	Mullion	3 ³ / ₈ " x 2" x RL	PIN	46
995 (1416339)	Chamfer Strip	3 ³ / ₄ " x 3 ³ / ₄ " x RL	PIN	51
1217 (1394228)	Panel Mould	1 ¹ / ₂ " x 1-7 ⁷ / ₁₆ " x RL	PIN	47
1219 (1394229)	Wainscot Cap	1 ¹ / ₁₆ " x 1-5 ⁵ / ₈ " x RL	PIN	56
02FJ (1394147)	Panel Mould	1 ¹ / ₁₆ " x 2-7 ⁷ / ₁₆ " x 16'	MDF/UL	48
02P (1394149)	Panel Mould	1 ¹ / ₁₆ " x 2-7 ⁷ / ₁₆ " x 16'	PFJ	48
05M (1394150)	Panel Mould	9 ⁹ / ₁₆ " x 1-9 ⁹ / ₁₆ " x 16'	MDF/UL	47
12S4SM (1577645)	Flat Stock	1 ¹ / ₁₆ " x 1-1 ¹ / ₂ " x 16'	MDF/UL	45
13S4SP1F17 (1662860)	Flat Stock	2 ¹ / ₃₂ " x 2-1 ¹ / ₂ " x 17'	PFJ	45
14S4SM (1566875)	Flat Stock	1 ¹ / ₁₆ " x 3-1 ¹ / ₂ " x 16'	MDF/UL	45
14S4SMR (1394259)	Flat Stock	3 ³ / ₄ " x 3-1 ¹ / ₂ " x 16'	MDF/UL	45
14S4SP1 (1382528)	Flat Stock	2 ¹ / ₃₂ " x 3-1 ¹ / ₂ " x 16'	PFJ	45
14S4SP1F17 (1394262)	Flat Stock	2 ¹ / ₃₂ " x 3-1 ¹ / ₂ " x 17'	PFJ	45
16S4SM (1511011)	Flat Stock	1 ¹ / ₁₆ " x 5-1 ¹ / ₂ " x 16'	MDF/UL	45
16S4SMR (1394309)	Flat Stock	3 ³ / ₄ " x 5-1 ¹ / ₂ " x 16'	MDF/UL	45
16S4SP1 (1394311)	Flat Stock	2 ¹ / ₃₂ " x 5-1 ¹ / ₂ " x 16'	PFJ	45
16YP2VJREV (1394324)	T & G Paneling	1 ¹ / ₁₆ " x 5-1 ¹ / ₂ " x 16'	PIN	56
17FJ (1394326)	Crown	1 ¹ / ₁₆ " x 5-5 ⁵ / ₈ " x 16'	FJR	36
18S4SM (1511014)	Flat Stock	1 ¹ / ₁₆ " x 7-1 ¹ / ₄ " x 16'	MDF/UL	45
18S4SMR (1394345)	Flat Stock	3 ³ / ₄ " x 7-1 ¹ / ₄ " x 16'	MDF/UL	45
18S4SP1 (1394347)	Flat Stock	2 ¹ / ₃₂ " x 7-1 ¹ / ₄ " x 16'	PFJ	45
32OBM (1405121)	Baseboard	1-1 ¹ / ₁₆ " x 4-1 ¹ / ₄ " x 17'	MDF/UL	15
37CCM (1394475)	Crown	2 ¹ / ₃₂ " x 5-1 ¹ / ₁₆ " x 16'	MDF/UL	38
39M (1394489)	Crown	1" x 7-3 ³ / ₁₆ " x 16'	MDF/UL	42
41M (1382814)	Crown	1-3 ³ / ₁₆ " x 6-5 ⁵ / ₁₆ " x 16'	MDF/UL	43
41SM (1394496)	Crown	7 ⁷ / ₈ " x 4-5 ⁵ / ₁₆ " x 16'	MDF/UL	43
41WM (1394497)	Crown	1-1 ¹ / ₈ " x 8" x 16'	MDF/UL	43
42P (1394500)	Panel Mould	1-1 ¹ / ₁₆ " x 1-9 ⁹ / ₁₆ " x 16'	PFJ	48
42PR (1394501)	Panel Mould	1-1 ¹ / ₁₆ " x 1-9 ⁹ / ₁₆ " x 16'	PFJ	48

STOCK CODE	PROFILE TYPE	DIMENSIONS	SPECIES	PAGE
43M (1382827)	Crown	1" x 6-1 ¹ / ₁₆ " x 16'	MDF/UL	38
45BCM (1394526)	Crown	1 ¹ / ₃₂ " x 5-1 ¹ / ₄ " x 16'	MDF/UL	37
45BCP (1392863)	Crown	9 ⁹ / ₁₆ " x 5-1 ¹ / ₄ " x 16'	PFJ	37
45LP (1394526)	Crown	9 ⁹ / ₁₆ " x 5-3 ³ / ₁₆ " x 16'	PFJ	37
45MD (1394528)	Crown	9 ⁹ / ₁₆ " x 5-1 ¹ / ₄ " x 16'	MDF/UL	37
45P (1382863)	Crown	1 ¹ / ₁₆ " x 5-1 ¹ / ₄ " x 16'	PFJ	37
47L (1382872)	Crown	9 ⁹ / ₁₆ " x 4-9 ⁹ / ₁₆ " x RL	PIN	36
47L FJ (1382873)	Crown	9 ⁹ / ₁₆ " x 4-9 ⁹ / ₁₆ " x 16'	FJR	36
47LP (1382874)	Crown	9 ⁹ / ₁₆ " x 4-9 ⁹ / ₁₆ " x 16'	PFJ	36
47M (1394542)	Crown	9 ⁹ / ₁₆ " x 4-5 ⁵ / ₈ " x 16'	MDF/UL	36
48M (1394550)	Crown	9 ⁹ / ₁₆ " x 4-1 ¹ / ₄ " x 16'	MDF/UL	35
48P (1394551)	Crown	9 ⁹ / ₁₆ " x 4-1 ¹ / ₄ " x 16'	PFJ	35
49L (1382883)	Crown	1 ¹ / ₂ " x 3-5 ⁵ / ₈ " x RL	PIN	34
49L FJ (1382884)	Crown	9 ⁹ / ₁₆ " x 3-9 ⁹ / ₁₆ " x 16'	FJR	34
49LP (1382885)	Crown	9 ⁹ / ₁₆ " x 3-9 ⁹ / ₁₆ " x 16'	PFJ	34
49MD (1394558)	Crown	9 ⁹ / ₁₆ " x 3-5 ⁵ / ₈ " x 16'	MDF/UL	34
49SMD (1394559)	Crown	1 ¹ / ₂ " x 3-5 ⁵ / ₈ " x 16'	MDF/UL	34
51P (1394575)	Crown	9 ⁹ / ₁₆ " x 3-1 ¹ / ₄ " x 16'	PFJ	35
52FJ (1394586)	Crown	9 ⁹ / ₁₆ " x 2-3 ³ / ₄ " x 16'	FJR	34
52P (1394587)	Crown	9 ⁹ / ₁₆ " x 2-3 ³ / ₄ " x 16'	PFJ	34
54P (1394593)	Crown	9 ⁹ / ₁₆ " x 2-1 ¹ / ₄ " x 16'	PFJ	35
74P (1394626)	Bed Mould	9 ⁹ / ₁₆ " x 1-3 ³ / ₄ " x 16'	PFJ	50
75FJ (1394628)	Bed Mould	9 ⁹ / ₁₆ " x 1-5 ⁵ / ₈ " x 16'	FJR	50
75P (1382995)	Bed Mould	9 ⁹ / ₁₆ " x 1-5 ⁵ / ₈ " x 16'	PFJ	50
97P (1383101)	Casing	1-1 ¹ / ₁₆ " x 3-1 ¹ / ₂ " x 16'	PFJ	27
100F08 (1382341)	Cove	1 ¹ / ₁₆ " x 1 ¹ / ₁₆ " x 8'	PIN	52
100F16 (1394153)	Cove	1 ¹ / ₁₆ " x 1 ¹ / ₁₆ " x 16'	PIN	52
1000 (1626643)	Cove	1 ¹ / ₁₆ " x 1 ¹ / ₁₆ " x RL	0	52
1050 (1394169)	Quarter Round	3 ³ / ₄ " x 3 ³ / ₄ " x RL	0	54
110S4SM (1521204)	Flat Stock	1 ¹ / ₁₆ " x 9-1 ¹ / ₄ " x 16'	MDF/UL	45
110S4SMR (1394183)	Flat Stock	3 ³ / ₄ " x 9-1 ¹ / ₄ " x 16'	MDF/UL	45
110S4SP1 (1394185)	Flat Stock	2 ¹ / ₃₂ " x 9-1 ¹ / ₄ " x 16'	PFJ	45
112S4SM (1484204)	Flat Stock	1 ¹ / ₁₆ " x 11-1 ¹ / ₄ " x 16'	MDF/UL	45
112S4SMR (1394204)	Flat Stock	3 ³ / ₄ " x 11-1 ¹ / ₄ " x 16'	MDF/UL	45
112S4SP1 (1382427)	Flat Stock	2 ¹ / ₃₂ " x 11-1 ¹ / ₄ " x 16'	PFJ	45
137P (1394247)	Screen Mould	1 ¹ / ₂ " x 1-1 ¹ / ₄ " x 16'	PFJ	56
116S4SMR (1673320)	Board	3 ³ / ₄ " x 15-1 ¹ / ₄ " x 16'	MDF/UL	45
1260 (1394234)	Baseboard Shoe	1 ¹ / ₂ " x 3 ³ / ₄ " x RL	0	17
1270 (1394236)	Baseboard Shoe	3 ³ / ₈ " x 3 ³ / ₄ " x RL	0	17
129P (1676530)	Baseboard Shoe	7 ⁷ / ₁₆ " x 1 ¹ / ₁₆ " x 16'	LVL	17
150P (1394274)	Sash Bead	1 ¹ / ₂ " x 1-1 ¹ / ₂ " x 16'	PFJ	55
153P (1394275)	Panel Mould	5 ⁵ / ₈ " x 1-1 ¹ / ₂ " x 16'	PFJ	47
163E (1461928)	Baseboard	1 ¹ / ₁₆ " x 5-1 ¹ / ₄ " x RL	PIN	10
163E7MD (1394281)	Baseboard	9 ⁹ / ₁₆ " x 7-1 ¹ / ₄ " x 16'	MDF/UL	10
163E7MS (1394282)	Baseboard	1 ¹ / ₂ " x 7-1 ¹ / ₄ " x 16'	MDF/UL	11
163E7P (1382542)	Baseboard	1 ¹ / ₁₆ " x 7-1 ¹ / ₄ " x 16'	PFJ	10
163E7S FJ (1670870)	Baseboard	9 ⁹ / ₁₆ " x 7-1 ¹ / ₄ " x 16'	FJR	10

INDEX

STOCK CODE	PROFILE TYPE	DIMENSIONS	SPECIES	PAGE
163E7SP (1394284)	Baseboard	9/16" x 7-1/4" x 16'	PFJ	10
163E9M (1394285)	Baseboard	9/16" x 9-1/4" x 16'	MDF/UL	10
163EMD (1394288)	Baseboard	9/16" x 5-1/4" x 16'	MDF/UL	10
163EMSD (1394289)	Baseboard	1/2" x 5-1/4" x 16'	MDF/UL	11
163EP (1382548)	Baseboard	11/16" x 5-1/4" x 16'	PFJ	10
163ESFJ (1382550)	Baseboard	9/16" x 5-1/4" x 16'	FJR	10
163ESP (1382551)	Baseboard	9/16" x 5-1/4" x 16'	PFJ	10
163FJ (1382553)	Baseboard Cap	11/16" x 1-3/8" x 16'	FJR	16
163P (1394296)	Baseboard Cap	11/16" x 1-3/8" x 16'	PFJ	16
167P (1382569)	Baseboard Cap	11/16" x 1-1/8" x 16'	PFJ	16
180P (1382605)	Brick Mould	1-1/4" x 2" x 17'	PFJ	51
180PI85 (1394330)	Brick Mould	1-1/4" x 2" x 85"	PFJ	51
180PVCF18 (1382607)	Brick Mould	1-1/4" x 2" x 18'	PVC	51
200P (1394361)	Back Band	1-3/8" x 2" x 17'	PFJ	8
205F08 (1394364)	Corner Guard	1-1/8" x 1-1/8" x 8'	PIN	51
205F16 (1394365)	Corner Guard	1-1/8" x 1-1/8" x 16'	PIN	51
206L (1484580)	Corner Guard	11/16" x 11/16" x RL	PIN	51
206LF16 (1639733)	Corner Guard	11/16" x 11/16" x 16'	PIN	51
210P (1382653)	Rake Mould	11/16" x 1-5/8" x 16'	PFJ	54
212P (1394374)	Rake Mould	11/16" x 2-1/2" x 16'	PFJ	54
231F16 (1394379)	Hand Rail	1-7/16" x 1-5/8" x 16'	PIN	53
239P (1394384)	Square	3/4" x 3/4" x 8'	PFJ	55
240F16 (1394386)	Hand Rail	1-1/4" x 2-1/4" x 16'	PIN	53
240P (1382676)	Hand Rail	1-1/4" x 2-1/4" x 17'	PFJ	53
249P (1394393)	Flat Stock	11/16" x 1-1/2" x 16'	PFJ	45
268SP (1394397)	Lattice	1/4" x 1-1/8" x 16'	PIN-PRIMED	53
273FJ (1394399)	Picture Mould	11/16" x 1-3/4" x 16'	FJR	53
273P (1394400)	Picture Mould	11/16" x 1-3/4" x 16'	PFJ	53
282FJ (1394406)	Back Band	1-5/8" x 1-3/8" x 17'	FJR	8
284P (1394407)	Back Band	1-1/8" x 1-5/8" x 17'	PFJ	7
297P (1382708)	Chair Rail	11/16" x 3" x 16'	PFJ	32
298FJ (1394411)	Chair Rail	11/16" x 2-3/4" x 16'	FJR	31
298P (1394412)	Chair Rail	11/16" x 2-3/4" x 16'	PFJ	31
299FJ (1670589)	Chair Rail	1-1/8" x 2-1/2" x 16'	FJR	31
299P (1394413)	Chair Rail	1-1/8" x 2-1/2" x 16'	PFJ	31
300FJ (1394416)	Chair Rail	1-1/16" x 3" x 16'	FJR	32
300P (1382712)	Chair Rail	1-1/16" x 3" x 16'	PFJ	32
324FJ185 (1394425)	Casing	11/16" x 2-1/4" x 85"	FJR	18
324I85 (1394426)	Casing	11/16" x 2-1/4" x 85"	PIN	18
324P (1394427)	Casing	11/16" x 2-1/4" x 16'	PFJ	18
324PI85 (1637309)	Casing	11/16" x 2-1/4" x 85"	PFJ	18
327P (1382725)	Casing	11/16" x 2-1/4" x 14'	PFJ	18
327PI85 (1382728)	Casing	11/16" x 2-1/4" x 85"	PFJ	18
341P (1394438)	Casing	11/16" x 3-1/2" x 17'	PFJ	28
341PI88 (1394439)	Casing	11/16" x 3-1/2" x 88"	PFJ	28
350P (1394446)	Casing	11/16" x 3-1/2" x 17'	PFJ	28
356FJF17 (1638047)	Casing	5/8" x 2-1/4" x 17'	FJR	21

STOCK CODE	PROFILE TYPE	DIMENSIONS	SPECIES	PAGE
356FJ185 (1382743)	Casing	5/8" x 2-1/4" x 85"	FJR	21
356I85 (1394450)	Casing	21/32" x 2-1/4" x 85"	PIN	21
356MD (1394451)	Casing	5/8" x 2-1/4" x 14'	MDF/UL	21
356PF17 (1416093)	Casing	5/8" x 2-1/4" x 17'	PFJ	21
356PI85 (1382748)	Casing	5/8" x 2-1/4" x 85"	PFJ	21
361PF17 (1394457)	Casing	11/16" x 3-1/4" x 17'	PFJ	23
361PI87 (1394458)	Casing	11/16" x 3-1/4" x 87"	PFJ	23
366M (1394461)	Casing	9/16" x 2-1/4" x 14'	MDF/UL	19
366PI85 (1394463)	Casing	11/16" x 2-1/4" x 85"	PFJ	19
371FJ186 (1670585)	Casing	11/16" x 2-15/16" x 86"	FJR	23
371P (1394465)	Casing	11/16" x 2-15/16" x 15'	PFJ	23
376PF17 (1394471)	Casing	11/16" x 2-1/4" x 17'	PFJ	23
385OBMD (1405168)	Baseboard	9/16" x 5-1/2" x 16'	MDF/UL	13
387P (1394478)	Casing	5/8" x 2-1/4" x 16'	PFJ	18
390P (1382796)	Chair Rail	11/16" x 2-5/8" x 16'	PFJ	31
394FJ (1394483)	Chair Rail	1-1/16" x 2-5/8" x 16'	FJR	32
397FJ (1394484)	Chair Rail	1" x 3-1/2" x 16'	FJR	33
397M (1382798)	Chair Rail	1" x 3-1/2" x 16'	PFJ	33
398FJ (1394486)	Chair Rail	1/2" x 5-1/4" x 16'	FJR	33
399PF17 (1394487)	Casing	29/32" x 3-7/32" x 17'	PFJ	26
399PI88 (1394488)	Casing	29/32" x 3-7/32" x 88"	PFJ	26
401LP (1394491)	Casing	11/16" x 2-3/4" x 17'	PFJ	22
401LPI87 (1394492)	Casing	11/16" x 2-3/4" x 87"	PFJ	22
425P (1394499)	Casing	11/16" x 4-1/4" x 17'	PFJ	28
440M (1644964)	Crown	21/32" x 4-1/4" x 16'	MDF/UL	40
442P (1394507)	Casing	11/16" x 2-1/4" x 14'	PFJ	19
444L (1382834)	Casing	11/16" x 3-1/4" x RL	PIN	21
444LFJF17 (1394510)	Casing	11/16" x 3-1/4" x 17'	FJR	21
444LFJ187 (1394511)	Casing	11/16" x 3-1/4" x 87"	FJR	21
444LM (1394512)	Casing	9/16" x 3-1/4" x 16'	MDF/UL	21
444LPF17 (1394513)	Casing	11/16" x 3-1/4" x 17'	PFJ	21
444LPI87 (1394514)	Casing	11/16" x 3-1/4" x 87"	PFJ	21
445FJF17 (1394516)	Casing	11/16" x 3-1/4" x 17'	FJR	23
445FJ1102 (1405210)	Casing	11/16" x 3-1/4" x 102"	FJR	23
445FJ187 (1382841)	Casing	11/16" x 3-1/4" x 87"	FJR	23
445M (1382843)	Casing	9/16" x 3-1/4" x 16'	MDF/UL	23
445PF17 (1394520)	Casing	11/16" x 3-1/4" x 17'	PFJ	23
445PI87 (1382849)	Casing	11/16" x 3-1/4" x 87"	PFJ	23
470FJ (1394535)	Casing	1-1/16" x 3-3/4" x 17'	FJR	27
481BBM (1394546)	Casing	11/16" x 3-1/2" x 16'	MDF/UL	25
481BBM190 (1394547)	Casing	11/16" x 3-1/2" x 90"	MDF/UL	25
481BP (1394548)	Casing	1-3/16" x 4-1/4" x 17'	PFJ	29
481PF17 (1394549)	Casing	1-3/16" x 4-9/16" x 17'	PFJ	30
481SFJF17 (1671103)	Casing	11/16" x 3-1/2" x 17'	FJR	25
504LMS (1394564)	Crown	11/16" x 7" x 16'	MDF/UL	39
504LPF17 (1394566)	Casing	11/16" x 2-3/16" x 17'	PFJ	22
505M (1394567)	Crown	1" x 7" x 16'	MDF/UL	41

STOCK CODE	PROFILE TYPE	DIMENSIONS	SPECIES	PAGE
522P [1394577]	Casing	3/4" x 3-1/2" x 17'	PFJ	22
523FJ [1394578]	Casing	1-1/16" x 3-1/2" x 17'	FJR	27
523FJI88 [1394580]	Casing	1-1/16" x 3-1/2" x 88"	FJR	27
523FJI102 [1394579]	Casing	1-1/16" x 3-1/2" x 102"	FJR	27
523M [1382899]	Casing	1" x 3-1/2" x 16'	MDF/UL	27
523P [1462226]	Casing	1-1/16" x 3-1/2" x 17'	PFJ	27
523PI88 [1394584]	Casing	1-1/16" x 3-1/2" x 88"	PFJ	27
524P [1394585]	Casing	1" x 4-1/4" x 17'	PFJ	29
534P [1394589]	Casing	1-1/16" x 3-1/2" x 17'	PFJ	26
548S4SP1 [1405290]	Flat Stock	1" x 7-1/4" x 16'	PFJ	45
553P [1394594]	Casing	11/16" x 3-1/2" x 17'	PFJ	28
600M [1644965]	Crown	23/32" x 6-3/8" x 16'	MDF/UL	41
600P [1394597]	Casing	5/8" x 3-1/2" x 16'	PFJ	30
606P [1394599]	Casing	11/16" x 5-1/2" x 16'	PFJ	30
618FJ [1567252]	Baseboard	9/16" x 5-1/4" x 16'	FJR	9
618M [1382932]	Baseboard	1/2" x 5-1/4" x 16'	MDF/UL	9
618P [1382933]	Baseboard	9/16" x 5-1/4" x 16'	PFJ	9
620FJ [1567253]	Baseboard	9/16" x 4-1/4" x 16'	FJR	9
620M [1382937]	Baseboard	1/2" x 4-1/4" x 16'	MDF/UL	9
620P [1394610]	Baseboard	9/16" x 4-1/4" x 16'	PFJ	9
623FJ [1382944]	Baseboard	9/16" x 3-1/4" x 16'	FJR	9
623MD [1566985]	Baseboard	1/2" x 3-1/4" x 16'	MDF/UL	9
623P [1382947]	Baseboard	9/16" x 3-1/4" x 16'	PFJ	9
631LP [1416244]	Baseboard	9/16" x 5-1/4" x 16'	PFJ	13
655M [1394617]	Crown	3/4" x 5-1/4" x 16'	MDF/UL	40
675M [1394618]	Crown	3/4" x 7-1/4" x 16'	MDF/UL	43
713P [1382973]	Baseboard	9/16" x 3-1/4" x 16'	PFJ	12
730P [1394624]	Panel Mould	5/8" x 1-5/8" x 16'	PFJ	47
750WM [1382988]	Baseboard	1/2" x 5-1/4" x 16'	MDF/UL	10
887PI102 [1394637]	Door Stop	3/8" x 1-1/4" x 102"	PFJ	44
887PF17 [1685883]	Door Stop	3/8" x 11/4" x 17'	PFJ	44
940FJ [1670587]	Door Stop	3/8" x 7/8" x 16'	FJR	44
953P [1394647]	Sash Bead	7/16" x 1-1/8" x 16'	PFJ	55
956LWWM [1394648]	Chair Rail	1/2" x 5-1/4" x 16'	MDF/UL	33
956WWM [1383087]	Chair Rail	1/2" x 4-1/4" x 16'	MDF/UL	33
957FJ [1394651]	Chair Rail	1/2" x 4-1/2" x 16'	FJR	33
957P [1394652]	Chair Rail	1/2" x 4-1/2" x 16'	PFJ	33
987L [1394662]	Mullion	3/8" x 1-3/8" x RL	PIN	46
988L [1394663]	Mullion	3/8" x 1-1/2" x RL	PIN	46
989L [1394665]	Mullion	3/8" x 1-1/8" x RL	MDF/UL	46
989LFJ [1394666]	Mullion	3/8" x 1-1/8" x 16'	FJR	46
1021FJ [1567235]	Stool	11/16" x 7-1/4" x 16'	FJR	49
1021M [1382351]	Stool	9/16" x 5-1/4" x 16'	MDF/UL	49
1021P [1577734]	Stool	11/16" x 5-1/4" x 16'	PFJ	49
1021WP [1577736]	Stool	11/16" x 7-1/4" x 16'	PFJ	49
1021WM [1394161]	Stool	11/16" x 7-1/4" x 16'	MDF/UL	49
1022BNP [1394164]	Stool	11/16" x 1-5/8" x 16'	PFJ	49

STOCK CODE	PROFILE TYPE	DIMENSIONS	SPECIES	PAGE
1022M [1382355]	Stool	9/16" x 4-1/2" x 16'	MDF/UL	49
1163OD [1394218]	Stool	1-1/16" x 3-1/4" x 16'	PIN	49
1163P [1382440]	Stool	1-1/16" x 3-1/4" x 16'	PFJ	49
1164P [1382443]	Stool	1-1/16" x 2-3/4" x 16'	PFJ	49
1195FJ [1394225]	Stool	11/16" x 2-7/16" x 16'	FJR	49
1195P [1394226]	Stool	11/16" x 2-7/16" x 16'	PFJ	49
1305PF07 [1382486]	Astragal	1-1/4" x 2" x 7'	PFJ	50
2153M [1394376]	Crown	3/4" x 5-1/4" x 16'	MDF/UL	41
2413M [1394389]	Crown	13/16" x 5-1/4" x 16'	MDF/UL	40
2413P [1394390]	Crown	21/32" x 5-1/4" x 16'	PFJ	40
2413WM [1662831]	Crown	3/4" x 7-1/4" x 16'	MDF/UL	40
5030M [1382895]	Architrave	1-3/16" x 6-1/4" x 16'	MDF/UL	6
BC150FJP [1394672]	Baseboard Cap	21/32" x 1-13/32" x 16'	PFJ	16
CVS1B2PMD [1323956]	Baseboard	9/16" x 5-1/2" x 16'	MDF/UL	13
CVS1B3PMD [1674704]	Baseboard	9/16" x 7-1/4" x 16'	MDF/UL	13
DRJ4916P [1404762]	Jamb	1-3/16" x 4-9/16" x 81-11/16"	PFJ	45
DRJ499612P [1404763]	Jamb	1-3/16" x 4-9/16" x 97-11/16"	PFJ	45
DRJ699612P [1404764]	Jamb	1-3/16" x 6-9/16" x 97-11/16"	PFJ	45
FF34 [1327797]	Sheet Goods	3/4" x 4' x 8'	MDR	45
FF34UL [1404783]	Sheet Goods	3/4" x 4' x 8'	MDR	45
FJ4981 [1404784]	Jamb	22/32" x 3-1/2" x 81-11/16"	PIN	45
FJP478P80 [1404785]	Jamb	11/16" x 4-7/8" x 97-11/16"	PFJ	45
FJP4981P [1404786]	Jamb	11/16" x 4-9/16" x 81-11/16"	PFJ	45
FJP6981P80 [1404789]	Jamb	11/16" x 6-9/16" x 97-11/16"	PFJ	45
FJR1278P [1404792]	Jamb	11/16" x 2-7/8" x 16'	PFJ	45
FJR1478P [1404793]	Jamb	11/16" x 4-7/8" x 16'	FJR	45
FJR4204FJ [1404797]	Jamb	11/16" x 4-9/16" x 17'	FJR	45
FJR4204P [1382891]	Jamb	11/16" x 4-9/16" x 17'	FJR	45
FJR4981RP [1404800]	Jamb	11/16" x 4-9/16" x 81-11/16"	FJR	45
FJR4981RP80 [1415480]	Jamb	11/16" x 4-9/16" x 97-11/16"	FJR	45
FJR6198P [1404803]	Jamb	11/16" x 6-9/16" x 17'	FJR	45
H8P [1404807]	Casing	7/8" x 3" x 17'	PFJ	22
MFP5015 [1677969]	Architrave	1-1/2" x 5-1/2" x 16'	MDF/UL	6
MFP8281 [1626223]	Baseboard	1/2" x 6" x 16'	MDF/UL	11
MRFJ1021714 [1577819]	Stool	11/16" x 7-1/4" x 16'	FJR	49
SJS48057W [1404857]	Jamb	1-1/16" x 4-5/8" x 81-11/16"	PIN	45
SJS48058WFJ [1404858]	Jamb	1-1/16" x 4-5/8" x 81-11/16"	FJR	45
SJS48058WP [1404859]	Jamb	1-1/16" x 4-5/8" x 81-11/16"	PFJ	45
SJS49658WFJ [1639785]	Jamb	1-1/16" x 4-5/8" x 8'	FJR	45
SJS49658WP [1426537]	Jamb	1-1/16" x 4-5/8" x 97-11/16"	PFJ	45
SJS68058P [1393408]	Jamb	1-1/16" x 6-9/16" x 81-11/16"	PFJ	45
SJS68058WFJ [1644970]	Jamb	1-1/16" x 6-9/16" x 80"	FJR	45
SJS69658P [1404868]	Jamb	1-1/16" x 6-9/16" x 97-11/16"	PFJ	45
ZZRB9828FJ [1670861]	Casing	1-1/4" x 3-1/2" x 17'	FJR	26



METRIE



EXPLORE OTHER PRODUCTS FROM METRIE®

In addition to our vast profile assortment, we offer unique product solutions that make it easy to select and install millwork.



METRIE
option 

Curated moulding & interior door combinations that complement today's top décor trends.



 METRIE
complete.

Pre-painted & ready to install moulding solution that allows you to finish before you start.



METRIE

METRIE® IS NORTH AMERICA'S LEADING MANUFACTURER AND DISTRIBUTOR OF INTERIOR MOULDINGS.

Metrie has the broad reach and supply chain expertise of an industry leader with the personal touch of a family business. We're committed to delivering tailored solutions that make it easier to transform houses into homes.



METRIE PRODUCTS DISTRIBUTED BY:



STOCKED IN
ATLANTA ONLY

40 Hopson Road Se
Acworth, Ga 30102
T: 770.975.0223
F: 770.975.9786

METRIE.COM



STOCKED IN
CHARLOTTE ONLY

11445 Granite Street, Suite C
Charlotte, Nc 28273
T: 704.504.9880
F: 704.504.5794

