



# Variomec XS 900



Normet reserves the right to change this specification without further notice

Pictures may include options and additional equipment.

# INTRODUCTION



**Variomec XS 900** is a purpose-built and agile vehicle for variable transportation demands within 3.5 m x 3.5 m or larger tunnels. The vehicle has an FOPS/ROPS approved cargo compartment with a 6 m<sup>3</sup> volume and a 2000 kg payload capacity. The XS 900 can be equipped to serve several different transportation purposes.

The XS-series has a larger payload capacity compared to current light vehicles commonly used in underground mines. The XS-series offers a completely new level of safety, ergonomics, and total cost of ownership while retaining the high performance and mobility of the existing fleet.

The versatile XS-carrier features a unique fast-connecting load-end structure, which enables the utilization of one carrier for multiple processes, such as:

- Material deck with optional crane
- Explosives transportation
- Lubrication and fuel transportation
- Emergency vehicle

The basic carrier is equipped with readiness for all load-end applications, and changing the application takes only a few hours.

The Normet XS-series features a powerful Deutz Stage III / Tier 3-approved diesel engine and a reliable Linde hydrostatic transmission. The vehicle is equipped with a full chassis suspension system that enhances driving safety and comfort while reducing fatigue. This suspension system improves efficiency and speed, ensuring a safer and more comfortable experience for both the driver and passengers.

The Normet FOPS and ROPS-approved safety cabin provides superior visibility and a comfortable compartment for the driver and passengers. Designed for safe and easy entry and exit, the cabin has wide door openings, properly positioned handrails, and non-slip steps. The dashboard is user-friendly, and the multi-informational display (MID) provides all necessary information for the operator, including speed, operating hours, temperatures, safety alarms, and warnings, all of which can be recorded for further analysis.

The electric and control system is designed to withstand the harsh underground environment. The electric system consists of self-extinguishing wire harnesses with tinned and watertight conduits, and all exposed components are rated at least IP65.

The vehicle layout allows easy access to all service points, and all daily checks can be performed from ground level.

# TECHNICAL SPECIFICATION

## CARGO COMPARTMENT

Enclosed cargo compartment with 6 m<sup>3</sup> volume and 2000 kg payload capacity.

## ENGINE AND TRANSMISSION

**Deutz TCD 2012 L4, 96 kW/2200 rpm, Tier 3 / Stage IIIA approved**

Exhaust system for Deutz engine:

- Catalytic exhaust gas purifier and muffler
- Catalytic converter (DOC) & Diesel particulate filter (DPF)

Fuel tank capacity 110 l

### Linde hydrostatic transmission

Pump 105 cm<sup>3</sup>  
Motor 210 cm<sup>3</sup>

4-wheel drive

## PERFORMANCE

Tramming speed (horizontal) 30 km/h

Lateral gradient for tramming (continuous) 4°

Longitudinal gradient for tramming (continuous) 9°

Depending of machine configuration, lateral and longitudinal tramming gradient can temporarily be higher.

## AXLES AND BRAKES

Dana 212 Planetary type axles

Hydraulically powered dual-circuit oil immersed multidisc service brakes in both axles

Spring applied hydraulically released fail-safe -type parking/safety brakes in both axles

Leaf spring suspended chassis

## TYRES AND RIMS

Tire size:

- 9.00-20
- 8.25-15 (100 mm lower machine)

## STEERING

4-wheel steering with three steering modes

Front axle steering, concentric 4 WS and crab walk

Orbitrol type

Normet reserves the right to change this specification without further notice

## HYDRAULIC SYSTEM

Variable displacement pump system:  
190 bar, 90 l/min at 2200 rpm

Hydraulic oil tank capacity 100 l

## 24 VDC ELECTRICAL SYSTEM

LED driving and indicator lights

LED work lights

LED side lights

Warning LED light:

Color

- Amber
- Blue
- Red
- Green (n/a with rotating light pattern)
- White (n/a with rotating light pattern)

Light pattern

- Strobe
- Rotating

## DRIVER'S COMPARTMENT

Enclosed cabin, FOPS/ROPS approved

- Fresh air blower
- Heating and A/C

Driver's seat and seat belt:

Mechanically suspended T-back seat with 3-point seat belt

Cabin door interlock switches with safety brake application

Passenger's seat:

- Mechanically suspended T-back seat with 3-point seat belt
- 2 seats with 3-point seat belts

## MACHINE CONNECTIVITY

Machine connectivity hardware (WLAN/3G/4G/LTE)

Connectivity services:

- Analytics license for three years (includes access to analytics portal)
- Remote monitoring for one year

Pictures may include options and additional equipment.

## TECHNICAL DOCUMENTATION

Standard documents:

Instruction manuals, hard copy 2 pcs:

- English
- Russian
- One of destination EU languages

Spare parts manuals, hard copy 2 pcs:

- English
- Russian

PDF manuals on USB-stick 2 pcs, includes instruction and spare parts manuals

Additional documentation:

- Extra hard copies of manuals
- Extra PDF manuals
- LinkOne WebView electronic manuals
- Other than standard language manuals

## OTHER

6 kg hand held extinguisher

Painting and taping:

- Standard painting and taping
- Painting and taping according to customer specifications

Text labels in:

- En/Ru/One of destination EU languages
- Other language

Measurements:

- Noise
- Vibration
- Emissions

## ACCESSORIES

### PROCESS PRODUCTIVITY

- Communication system between cabin and cargo compartment
- Heat and noise insulation for cargo compartment
- Air conditioning for cargo compartment
- HEPA filter for cargo compartment
- Heating for cargo compartment
- Guard grills for cargo compartment windows
- Door interlock switches for cargo compartment
  - Warning signal for driver
  - Safety brake application

### CARRIER PRODUCTIVITY

- Two-piece windscreen
- Audio system
- HEPA filter for driver's compartment
- Heated mirrors
- 12 V 20 A power supply in cabin with socket and connector
- Auto engine shut down during idling
- Engine shut down delay
- Inlet plug for jump start
- Block heater with interior heater and battery charger
- Fuel operated pre-heater
- Fast fuel filling system
- Hand pump for filling of hydraulic tank
- Fluid evacuation panel with sampling points
- Automatic lubrication system
- Reversing camera:
  - 1 camera, 1 display
  - 3 cameras, 2 displays
  - 4 cameras, 1 display with recording support
- Spare rim and tyre
- Toolbox and maintenance tools
- Interior cooling fan
- Wax tape for electric connectors

### SAFETY

- Cabin door puddle lights
- Extra warning LED light
  - Color
    - Amber
    - Blue
    - Red
    - Green (n/a with rotating light pattern)
    - White (n/a with rotating light pattern)
  - Light pattern
    - Strobe
    - Rotating
- Direction lights (Green/Red)
  - Both lights always on
  - Lights follows driving direction
- Extra warning LED light with battery backup
  - Color
    - Amber
    - Blue
    - Red
    - Green (n/a with rotating light pattern)
    - White (n/a with rotating light pattern)
  - Light pattern
    - Strobe
    - Rotating
- Seat belt interlock switch applies safety brake
- Fire extinguisher system
  - Ansul A-101
    - Manual
    - Automatic, Checkfire:
      - 110
      - 210
- Extra 6 kg hand held fire extinguisher
- Grounding chain
- Emergency pump for brake release and steering
- Redundant brake monitoring system
- Methane monitoring system
- Protection guards for tunnel curtains
- Tyre pressure indicators
- Warning triangles
- Flash light with charger
- Hearing protectors
- Wheel chocks with brackets
- Service isolator for starter

## SERVICES

### NORMET SERVICES

Normet is committed to servicing its customers all over the world. We provide service from a single machine to an entire fleet. The Normet service offering consists of many different products from delivery of parts and training to fleet performance agreements.

More information check [normet.com](https://www.normet.com):

<https://www.normet.com/en/products-and-services>

**For any questions about Normet Services contact local Normet.**

<https://www.normet.com/en/contact/>

### SPARE PARTS

As a leading global Original Equipment Manufacturer, we are committed to providing a complete solution to your spare parts needs. All of Normet's spare parts are manufactured to the highest possible standards to help maintain the safety and profitability of your projects. Our spare parts improve efficiency and total cost of ownership throughout your operations.

Start a carefree journey with Normet equipment by having the right selection of parts available from the beginning.

#### **Spare part recommendation / Start-up Spare Part package:**

Available for the first 2000h\*: includes periodical service parts, most common wearing parts and other recommended parts. (\*Recommendations are based on average hours that can vary depending on worksite conditions.)

Underground, every part is critical!

More information check <https://www.normet.com>

### SERVICE AGREEMENTS

Service agreements are always customized to meet our customer needs, consisting of various Normet service products. The service solution is created together with the customer and the level of an agreement can vary with different support agreements (including e.g. parts, periodical maintenance, on-call services, and audits) up to guaranteed fleet availability or process performance (including e.g. parts, all maintenance activities, operator trainings and process audits).

Note that we can provide Digital solutions with connected equipment.

More information check [normet.com](https://www.normet.com).

### TRAININGS

Training services can be tailored to your individual needs and range from equipment service training to process application training.

We offer a sustainable training path from the beginning of your operation to the execution stage of your project.

More information check [normet.com](https://www.normet.com).

### COMMISSIONING

Equipment commissioning concerns **equipment familiarization**. This is included as part of Normet vehicle delivery. Safety introduction and operating basics for Normet Equipment. Review of Normet user and spare parts manuals. Hands-on equipment safety device operational training. Ensure product quality and customer satisfaction during handover.

**Commissioning includes machinery handover to customers and safety operating principles** without technical insights or process application training.

### EXTENDED COMMISSIONING

We offer an extended training package on top of standard commissioning. Normet provides extended commissioning services that offer basic insights into maintenance manuals, periodical and daily maintenance, as well as modern operating perspectives to maximize handling efficiency. Safety-oriented training ensures reliable operations for Battery Electric Vehicles and Diesel-Driven based on your vehicle fleet. This cost-effective solution covers the essential aspects of equipment operation, safety, and maintenance schedules.

To ensure continuous and maximized safe operations with your new equipment and to expand your knowledge scale of operations, this option is the most suitable and recommended option for extending your new equipment training. This cost-effective solution covers the essential aspects of equipment operation, safety, and maintenance schedules.

### UPGRADES AND MODIFICATIONS

We build our machines to last. We also understand that your needs on the ground can change - and reacting to that change makes a big difference in your productivity. Normet Upgrades & Modifications provide you with access to product improvements that meet your evolving requirements and let you stay one step ahead of the curve.

Contact your local Normet office for Upgrade offering to your fleet.

More information check [normet.com](https://www.normet.com).

## DIMENSIONS

Length	6570 mm	Wheel base	2750 mm
Width with 15" tires	1920 mm	Track	1760 mm
Width with 20" tires	2050 mm	Ground clearance	350 mm
Height with 15" tires	2240 mm	Turning radius outer	5100 mm
Height with 20" tires	2340 mm	Turning radius inner	2050 mm

### SIDE VIEW

Machine with 20" tires

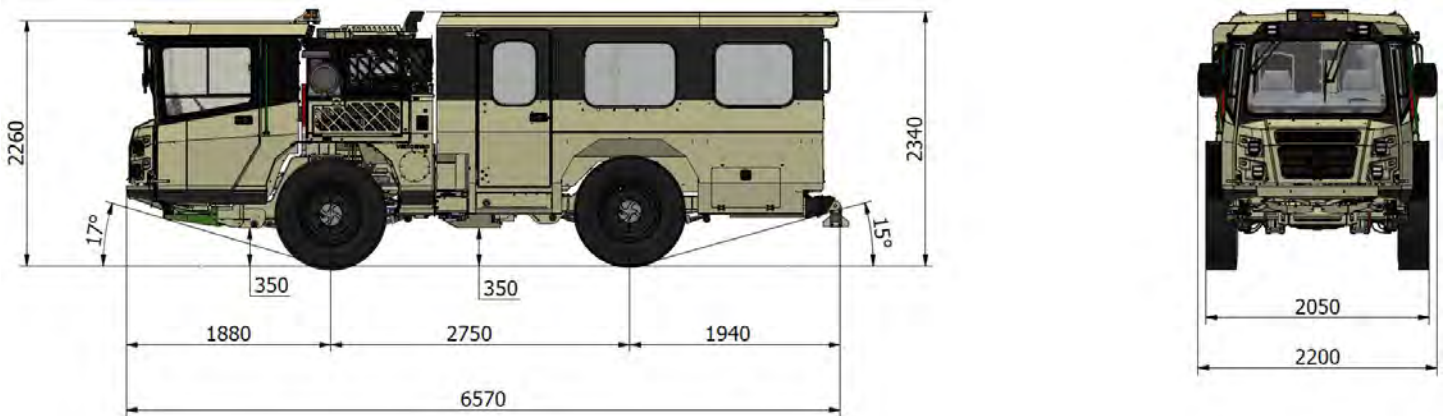

### TOP VIEW

Machine with 20" tires

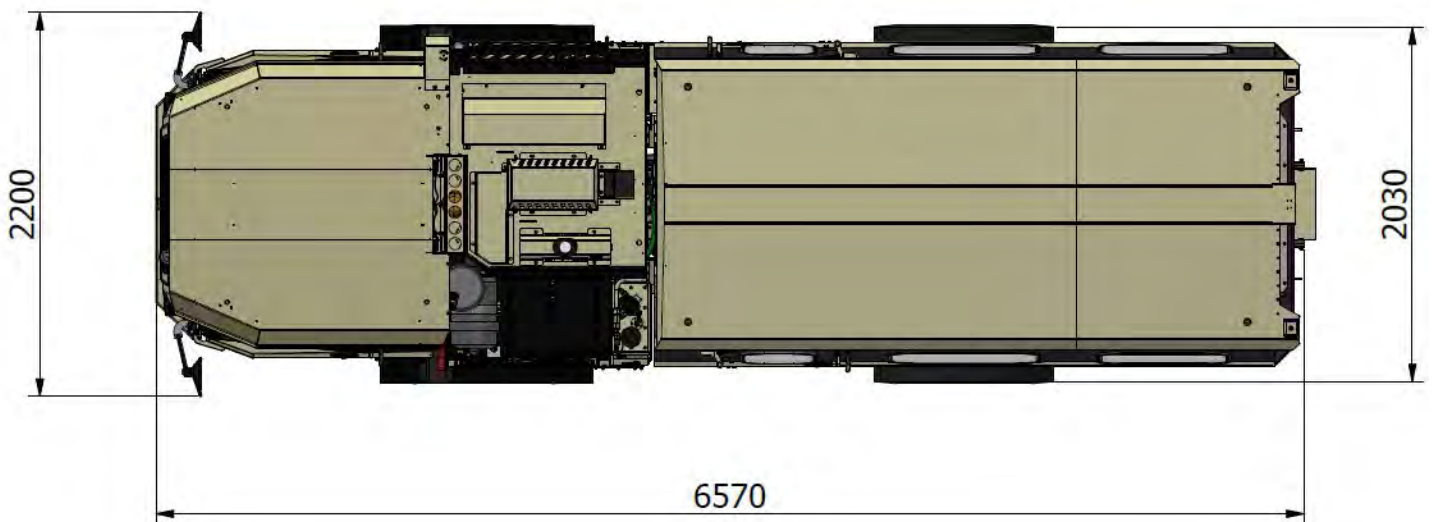

## SIDE VIEW

Machine with 15" tires

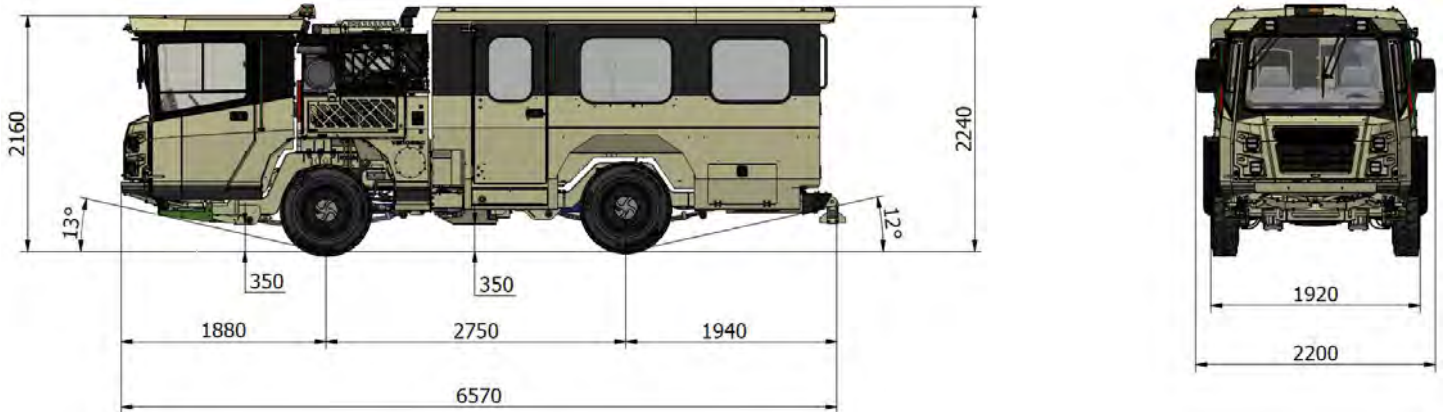

## TOP VIEW

Machine with 15" tires

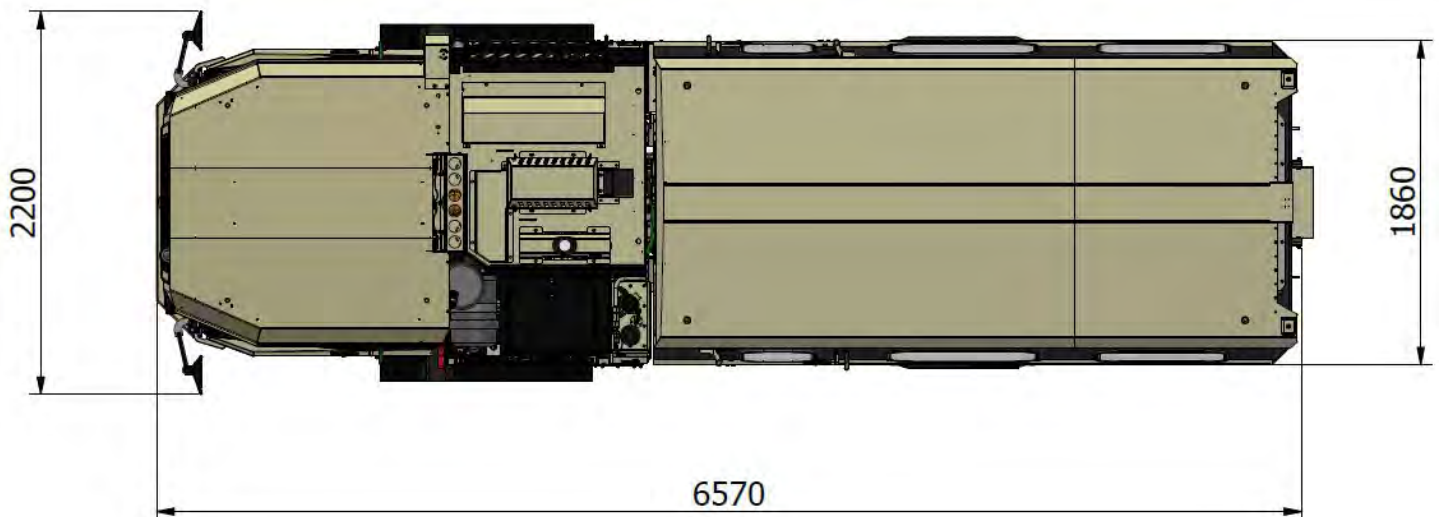



## TURNING RADIUS

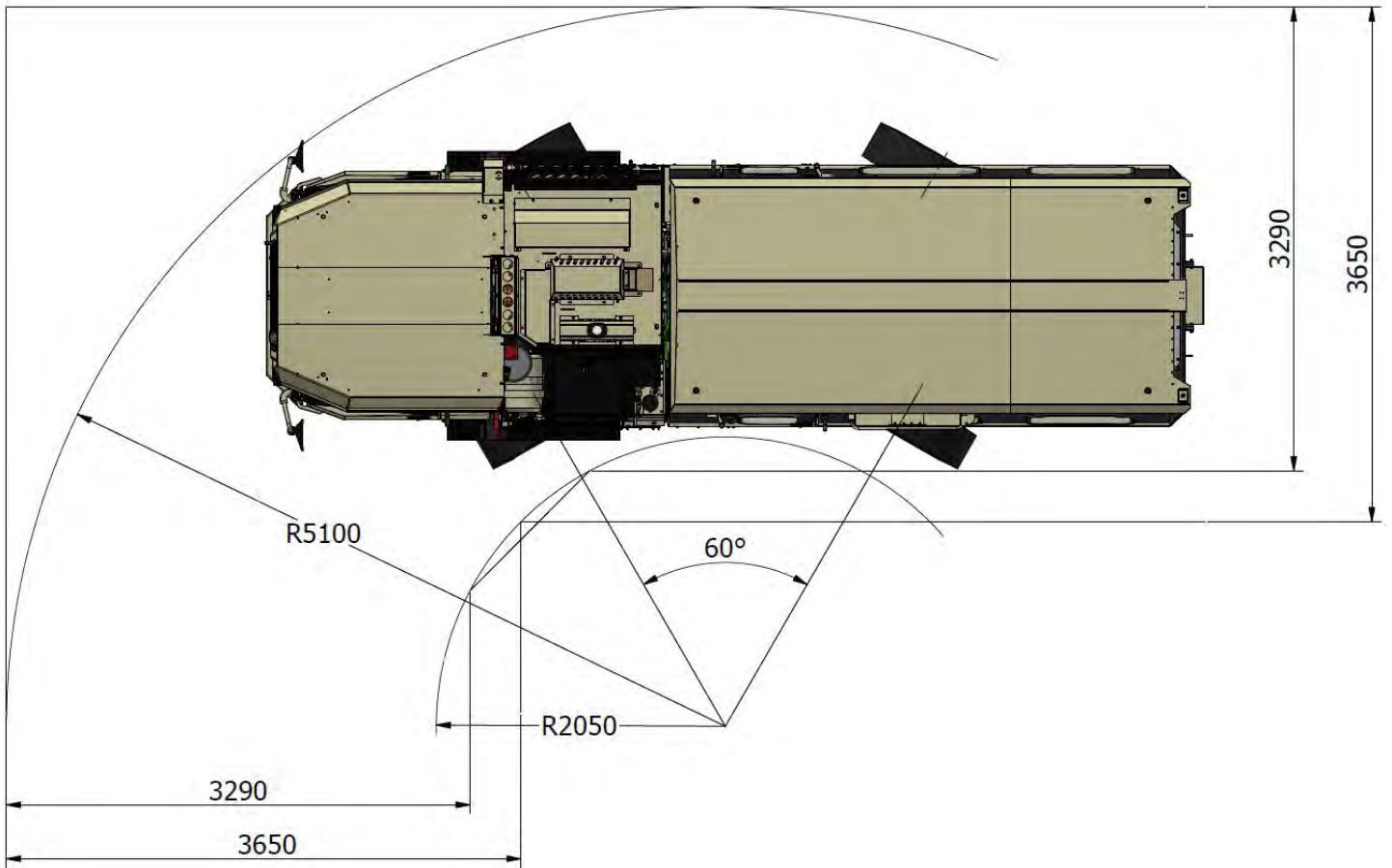

## TOP VIEW CARGO COMPARTMENT

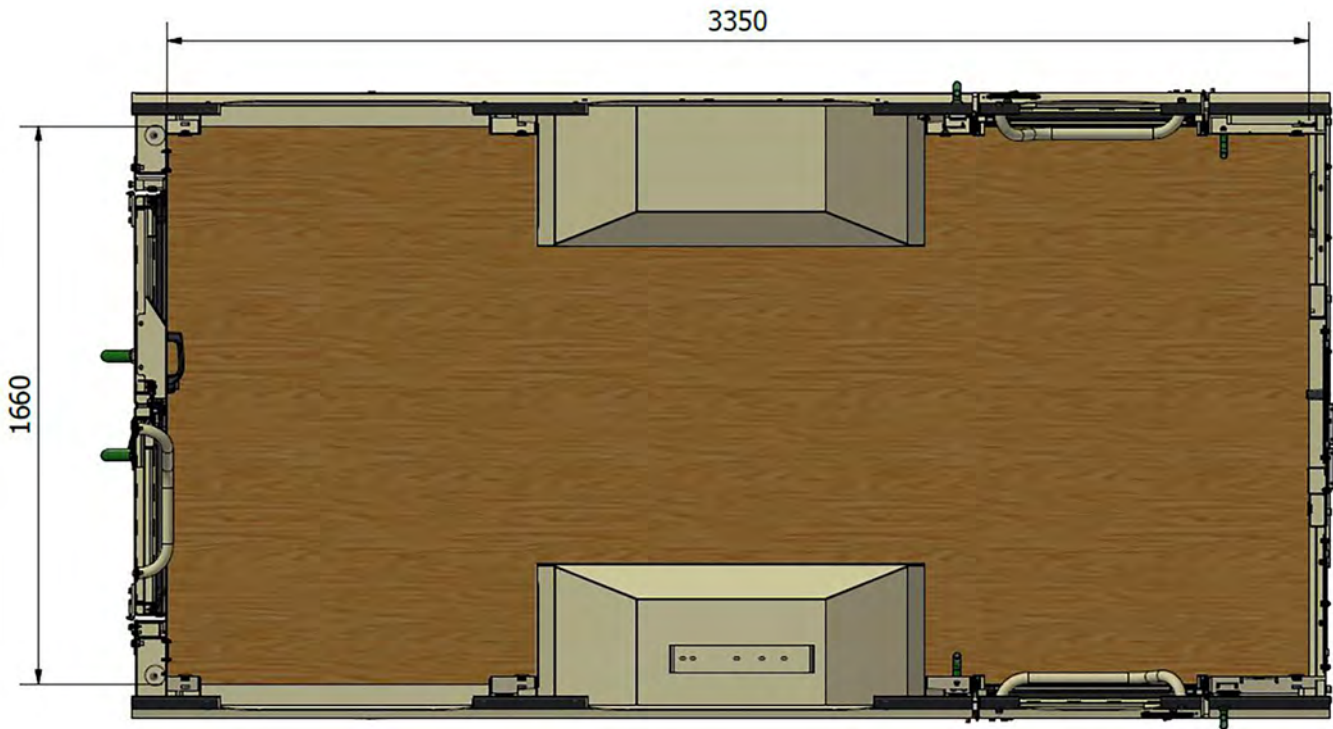

Normet reserves the right to change this specification without further notice

Pictures may include options and additional equipment.

## TRACTIVE EFFORTS

### OPERATING WEIGHT

Empty 7 000 kg  
 Fully loaded 9 000 kg  
 final machine weight variate in agree with selected options

### DEUTZ TCD 2012 L4, 96 KW

Performance curve DOC059943

#### Conversion chart

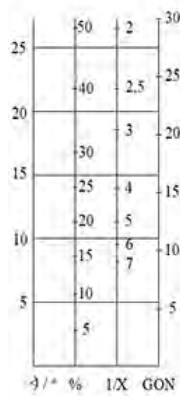

#### Gradeability kN

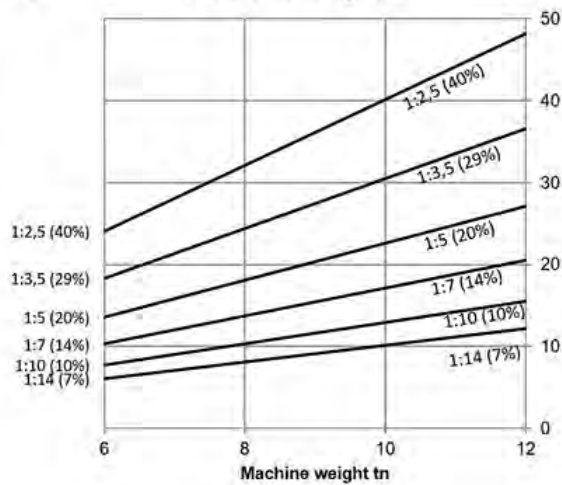

#### Tractive effort kN

