



Utimec MF 060 D

INTRODUCTION

MF 060 Dis typically used in tunneling projects with small or medium size tunnel cross sections. The maximum payload capacity is 10 t. The dump box capacity is 6 m³ and the tipping angle of the box is 85 degrees. The maximum height during tipping is 3.96 m. The dump box features a hatch which can be opened when the box is empty. This provides a good visibility when reversing.



POWER TRAIN

M-series units have powerful 4-cylinder liquid cooled turbo-charged engines, which power range is between 110-121 kW, depending of the selected engine model. Available emission standards are Tier 3 / Stage IIIA and Stage V that provide clean and efficient operation.

Machine is equipped with Dana hydrodynamic transmission and planetary type axles which have hydraulically powered dual-circuit oil immersed multidisc service brakes. Moreover, axles have spring applied hydraulically released fail-safe -type parking/safety brake.

SAFETY AND USABILITY

Vehicle has an optional front axle suspension system, which improve safety, driving comfort and increases component lifetime.

Normet's FOPS and ROPS approved safety cabin provides superior visibility and comfortable compartment for the driver and the passenger. Cabin controls are easy and ergonomic to use, and the multifunctional display (MID) provides driving information (speed, RPM, temperatures, safety warnings & alarms etc.), which can be recorded for further analysis.

Enclosed cabin provides low noise level ensuring safe and comfortable driving.

NorSmart 2 electric system is designed for harsh underground environment. System consists of self-extinguishing wire harnesses with tinned wires, water tight conduits and all exposed components are minimum IP65 protection class. In addition, vehicle layout allows easy access to all service points, all daily checks can be done from the ground level.

TECHNICAL SPECIFICATION

DUMP BOX

Volume	6 m ³
Tipping angle	85°
Tipping height	3960 mm

ENGINE AND TRANSMISSION

- **Deutz TCD 2013 L4, 120 kW/2300 rpm, Tier 3 / Stage IIIA approved**

Exhaust system for Deutz engine:

- Catalytic exhaust gas purifier and muffler
- Diesel particulate filter (DPF)

Fuel tank capacity 110 l

Dana 24000 series powershift transmission

3 speeds forward and reverse

4-wheel drive

Manual gear selector

- **Mercedes-Benz OM 904 LA, 110 kW/2200 rpm, with engine & exhaust brakes, Tier 3 / Stage IIIA approved**

Exhaust system for MB engine:

- Catalytic exhaust gas purifier and muffler
- Diesel particulate filter (DPF)

Fuel tank capacity 110 l

Dana 24000 series powershift transmission with lock-up

3 speeds forward and reverse

4-wheel drive

Gear selector:

- Manual
- Automatic

- **Cummins B4.5, 121 kW/2500 rpm with exhaust brake, Stage V approved**

Requires diesel exhaust fluid (DEF) and Ultra-low sulphur diesel (ULSD)

Diesel particulate filter (DPF)

Selective catalytic reduction (SCR)

DEF tank capacity: 19 l

Fuel tank capacity: 105 l

Dana 24000 series powershift transmission with lock-up

3 speeds forward and reverse

4-wheel drive

Gear selector:

- Manual
- Automatic

PERFORMANCE

Tramming speed (horizontal):

Deutz 27 km/h

Mercedes-Benz 28 km/h

Cummins 28 km/h

Lateral gradient for tramming (continuous) 4°

Longitudinal gradient for tramming (continuous) 9°

Depending of machine configuration, lateral and longitudinal tramming gradient can temporarily be higher.

AXLES AND BRAKES

Load end axle:

Dana 123 series fixed

Engine end axle:

Dana 123 series

- +/- 8° oscillation
- Hydro-pneumatic suspension and +/- 8° oscillation

Service brake: hydraulically powered dual-circuit oil immersed multidisc brakes in both axles

Safety/Parking brake: spring applied hydraulically released fail-safe -type brake

TYRES AND RIMS

Tyres:

- Nokian Tyres 12.00-20"
- Bridgestone 12.00-20"

Rims:

- Standard rims
- NDT inspected rims

STEERING

Orbitrol type hydraulic frame steering

Frame articulation +/- 40°

HYDRAULIC SYSTEM

Variable displacement pump system:

190 bar, 135 l/min at 2200 rpm

Hydraulic oil tank capacity 110 l

24 VDC ELECTRICAL SYSTEM

Main switch:

- Mechanical switch in battery box
- Electric switch with control in cabin and service switch in battery box
- Electric switch with control in cabin, start isolator and service switch in battery box

LED driving and indicator lights

LED work lights

LED side lights (left/right):

- White / White
- Green / Red
- Red / Green

Warning LED light:

Color

- Amber
- Blue
- Red
- Green (n/a with rotating light pattern)
- White (n/a with rotating light pattern)

Light pattern

- Strobe
- Rotating

DRIVER'S COMPARTMENT

Cabin type:

- Open cabin FOPS/ROPS approved
- Enclosed cabin FOPS/ROPS approved with sliding rear window

Driver's seat and seat belt:

- Air suspended T-back seat with 3-point seat belt
- Air suspended heavy duty seat with 3-point seat belt

Seat belt safety interlock for driver:

- Warning indicator in display
- Safety brake application

Cabin door interlock switches with safety brake application

Passenger's seat:

- T-back seat with 3-point seat belt
- Heavy duty seat with 3-point seat belt
- 2 person seat with fixed lap seat belts

Throttle and brake pedal layout:

- Front and side facing pedals with seat swivel
- Front facing pedals

Gear lever side:

- On right side of the steering wheel
- On left side of the steering wheel

MACHINE CONNECTIVITY

- Machine connectivity hardware (WLAN/3G/4G/LTE)
- Data lifetime license (Include connectivity hardware)
- Analytics lifetime license (Include connectivity hardware and data lifetime license)

TECHNICAL DOCUMENTATION

Standard documents:

Instruction manuals, hard copy 2 pcs:

- English
- Russian
- One of destination EU languages

Spare parts manuals, hard copy 2 pcs:

- English
- Russian

PDF manuals on USB-stick 2 pcs, includes instruction and spare parts manuals

Additional documentation:

- Extra hard copies of manuals
- Extra PDF manuals
- LinkOne WebView electronic manuals
- Other than standard language manuals

OTHER

Powder extinguisher:

- 6 kg
- 12 kg
- Ansul Sentry

Number of extinguishers:

- 1
- 2

Painting and taping:

- Standard painting and taping
- Painting and taping according to customer specifications

Text labels in:

- En/Ru/One of destination EU-languages
- Other language

Measurements:

- Noise
- Vibration
- Emissions

ACCESSORIES

PROCESS PRODUCTIVITY

- Front support legs
- Retarder

CARRIER PRODUCTIVITY

- Accessories for open cabin:
 - Protective grids
 - Windshield with wipers
- Accessories for enclosed cabin:
 - Audio system
 - Air conditioning with heating
 - Heated mirrors
- 12 V, 18 A power supply in cabin with socket and connector
- Auto engine shutdown during idling
- Engine shutdown delay
- Inlet plug for jump start
- Block heater with interior heater and battery charger 230 V (Interior heater available with enclosed cabin)
- Block heater with interior heater, battery charger, hydraulic oil and filter heaters 400 V (Interior heater available with enclosed cabin)
- Fuel operated pre-heater
- Fast fuel filling system
- Hand pump for filling of hydraulic tank
- Fluid evacuation panel with sampling points
- Automatic lubrication system
- Reversing camera
 - 1 camera, 1 display
 - 3 cameras, 2 displays
 - 4 cameras, 1 display. OACR/VCR system recording device with 72 hour memory
- Spare rim and tyre
- Toolbox and maintenance tools
- Interior cooling fan
- Wax tape for electric connectors

SAFETY

- Cabin door puddle lights
- Extra warning LED light (From the options below it is possible to choose 1-2 combinations)
 - Color
 - Amber
 - Blue
 - Red
 - Green (n/a with rotating light pattern)
 - White (n/a with rotating light pattern)
 - Light pattern
 - Strobe
 - Rotating
- Fire extinguisher system
 - Dry chemical Ansul A-101
 - Manual
 - Automatic, Checkfire 110
 - Liquid agent Fogmaker (Automatic)
- Gear lockout:
 - Forward:
 - Highest gear locked out
 - 2 highest gears locked out
 - Reverse:
 - Highest gear locked out
 - 2 highest gears locked out
- Engine end safety rails and ladder
- Front and rear grounding straps
 - Flat cable
 - Chain
- Pump for brake release
 - Electric pump
 - Hand pump
- Redundant brake monitoring system
- Hydraulic pressure monitoring kit
- Methane monitoring system
- Protection guards for tunnel curtains
- Tyre pressure indicators
- Additional wide angle mirrors (n/a with heated mirrors)
- Warning triangles
- Flashlight with charger
- Hearing protectors
- Wheel chocks with brackets

SERVICES

NORMET SERVICES

Our services cover the whole life cycle of your equipment. They include start-up and commissioning, genuine spare parts, upgrades & modifications, and remanufacturing, as well as rental and leasing offerings, and field services. We also offer improvement services such as operator training and process audits.

SPARE PARTS

Genuine parts from Normet Services ensure that you always have the highest quality parts available to keep your equipment up and running. Depending on your needs, we can offer everything from individual parts to complete parts contracts, and our professionals around the world have the experience to ensure that you have the parts you need when you need them.

Initial spare parts package:

Available for 1000h of use*. Includes periodical service, most common wearing parts and most critical safety parts.

Spare parts packages made for customer needs:

Available based on hours of use*. Includes periodical service, most common wearing parts and most critical safety parts.

* Recommendations are based on average hours – can vary a lot depending on work site conditions.

UPGRADES AND MODIFICATIONS

Our Upgrades and Modifications services are designed to ensure the economical, efficient and purposeful performance of your equipment over its entire life cycle. A service provided by a reliable OEM like Normet ensures the safety and performance of your equipment. Normet Upgrades and Modifications save you both time and money, while delivering the high quality you expect from us.

SERVICE CONTRACTS





With a service agreement, Normet manages your fleet with guaranteed availability and agreed costs, giving you transparency for your life cycle costs, annual operational budget and fleet uptime. This lets you focus on your core operations. Each service agreement is built and customized to meet the individual customer's needs from our portfolio of services. Depending on the level of service agreement you need, you can choose anything from basic technical support for an individual machine all the way up to services for your entire fleet, as well as process performance. The service levels we offer are:

- Parts Availability
- Fleet Support
- Fleet Availability
- Process Performance

The content of a service level can be tailored to meet your particular requirements.

TRAINING SERVICE

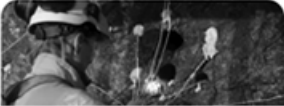
Our Training Services are available for you and your operators throughout the equipment lifecycle and they include:

				
	Operation & Maintenance	Spraying	Charging	Scaling
ADVANCED	Advanced fault diagnostics & troubleshooting	Concrete chemicals, testing and preparing for EFNARC-certificate test	-	-
INTERMEDIATE	Troubleshooting training Foundations of electrics, hydraulics and mechanics NorSmart	Advanced training in concrete spraying Economics of concrete spraying	Advanced training in explosives Economics of charging	Advanced training in scaling Economics of scaling
BASIC	Operation and Maintenance Training Basic Product Training	Basic understanding of concrete spraying	Basic understanding of charging	Basic understanding of scaling
LEVEL	SERVICE	PROCESS KNOWLEDGE		

START-UP AND COMMISSIONING

1. OPERATOR TRAINING

	Start-up training	Commissioning
1.1 Classroom training		
General introduction and operation of machine	Basic	No classroom training included in commissioning
Safety instructions	Basic	
Use of manuals	Basic	
Technical introduction of equipment	Basic	
Hands-on service and pre-operation checks	Basic	
Controls and driving (starting, driving, stopping, parking)	Basic	
1.2 Practical training		
Pre-operation checks	Basic	Introduction
Driving, starting, stopping, parking	Basic	Introduction
Preparing the machine for specific operation conditions	Basic	Not covered
Operation	Basic	Introduction
Washing the machine	Basic	Introduction
Troubleshooting	Basic	Basic

2. MAINTENANCE AND REPAIR TRAINING

General operation of machines	Basic	Introduction
Symbols of drawings and codes	Basic	Not covered
Understanding hydraulic and electric schematics	Basic	Introduction
Control systems	Basic	Introduction
Function of main components (depending on equipment)	Basic	Introduction
Locations of components in the machine	Basic	Not covered
Periodical maintenance	Basic	Introduction
Troubleshooting	Basic	Not covered
Use of manuals	Basic	Introduction
Connection of hydraulic and electrical equipment	Basic	Not covered

DIMENSIONS

Length	7560 mm	Track	1670 mm
Width	2000 mm	Ground clearance as shown	360 mm
Height	2200 mm	Turning radius outer	6550 mm
Height of cabin	2300 mm	Turning radius inner	3900 mm
Wheel base	3650 mm		

SIDE VIEW – BASIC MACHINE

Dimensions in () apply when the cabin is installed in the upper or lower position.

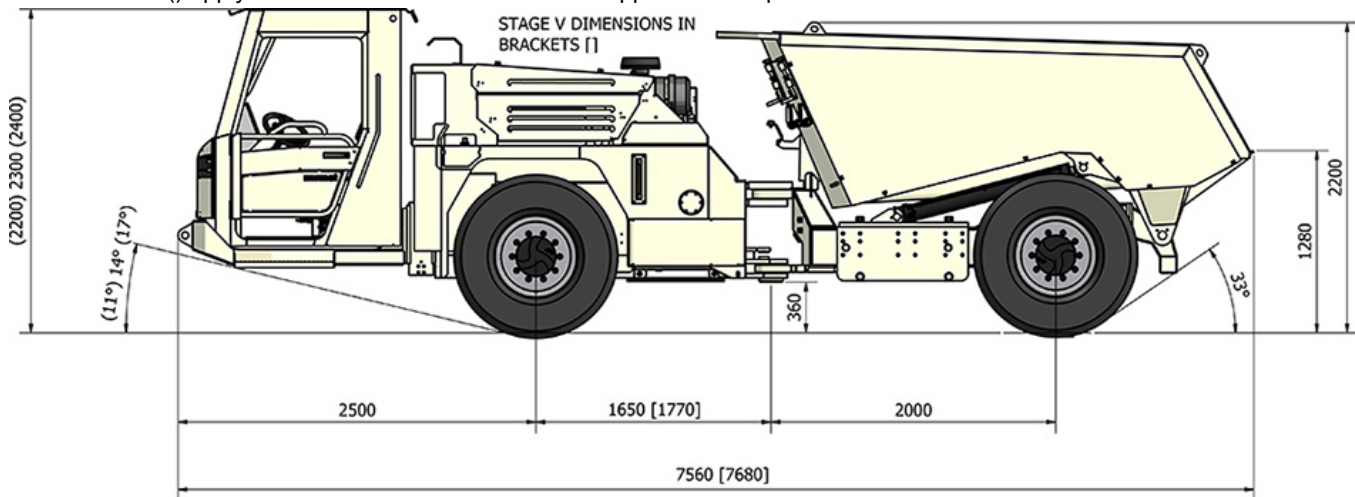

SIDE VIEW – MACHINE WITH OPTIONS

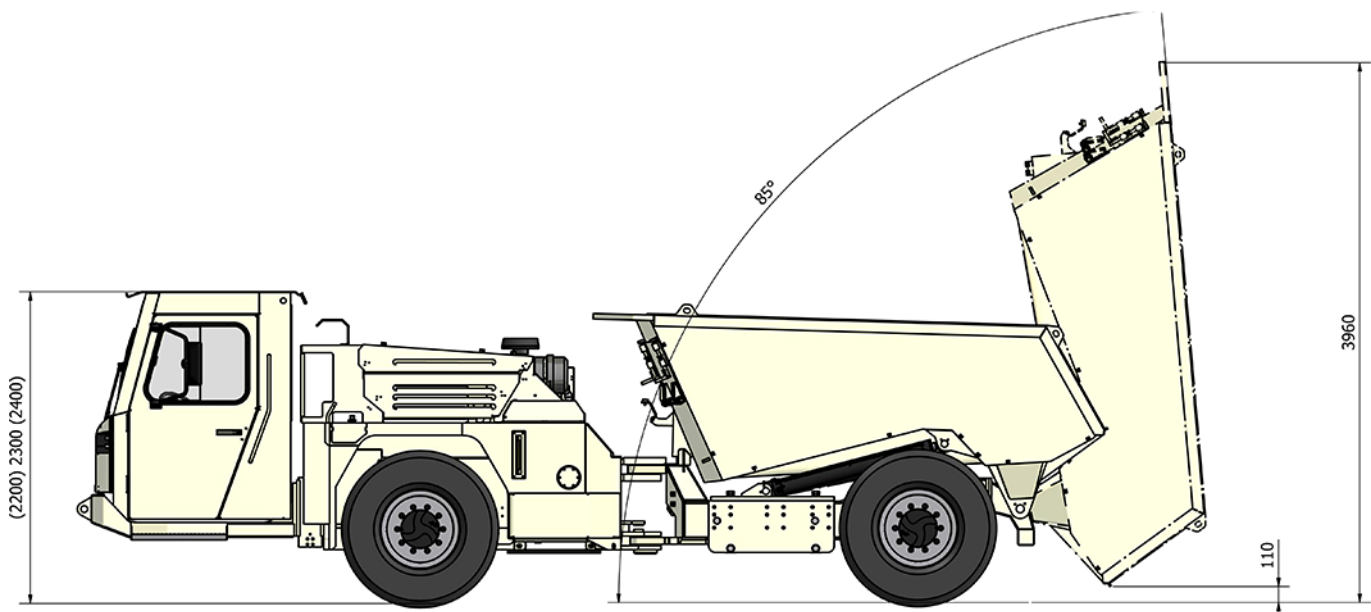

TURNING RADIUS

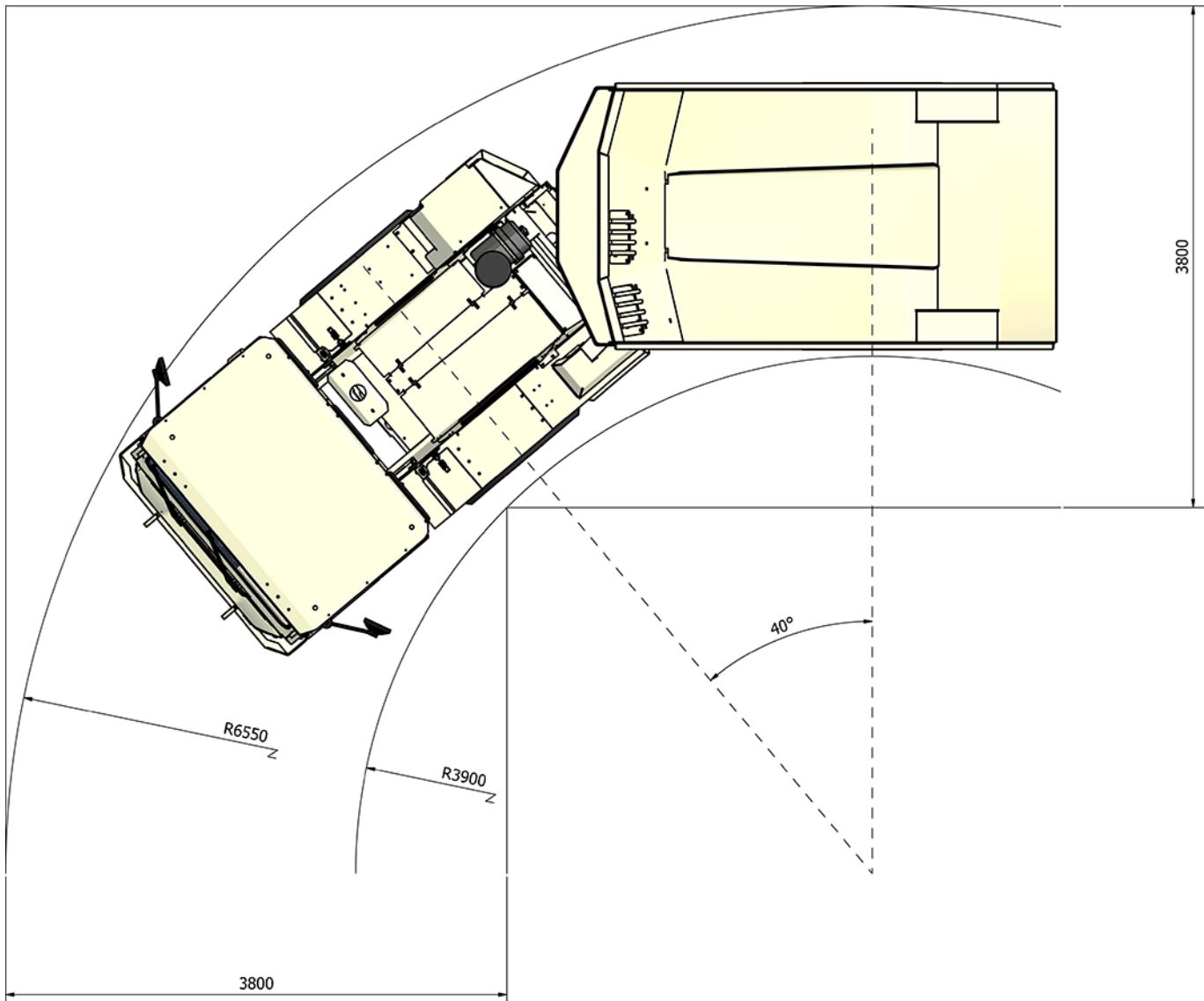

Normet reserves the right to change this specification without further notice

Pictures may include options and additional equipment.

TOP VIEW

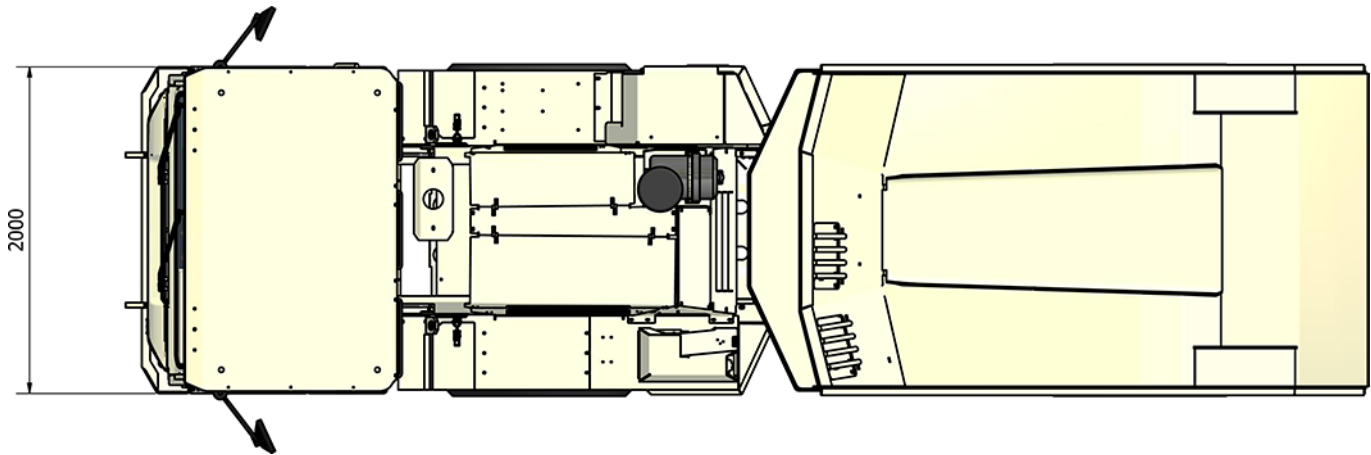

TRACTIVE EFFORTS

OPERATING WEIGHT

Empty	11 500 kg
Fully loaded	21 500 kg

DEUTZ TCD 2013 L4, 120 KW

Performance curve DOC060005

Conversion chart

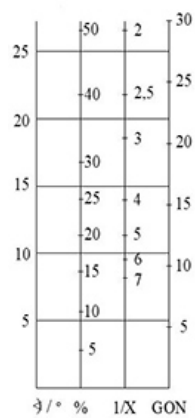

Gradeability kN

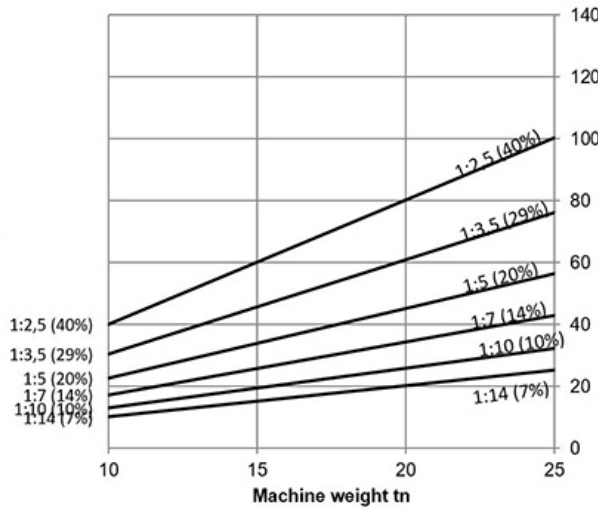

Tractive effort kN

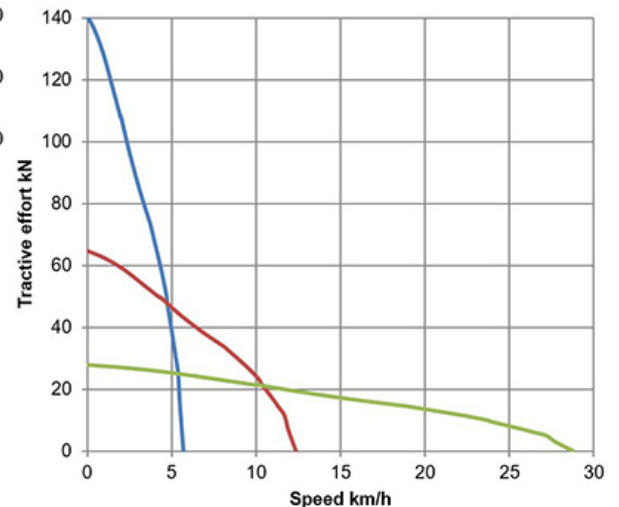

MERCEDES-BENZ OM 904 LA 110 KW

Performance curve with lock-up 100006272

CONVERSION CHART

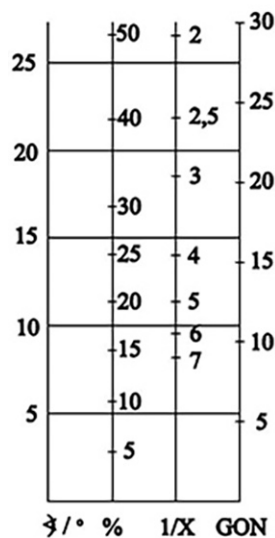

GRADIENT

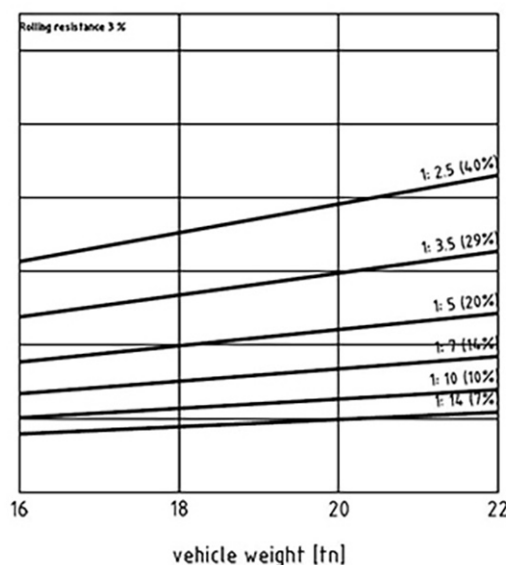

TRACTIVE EFFORT

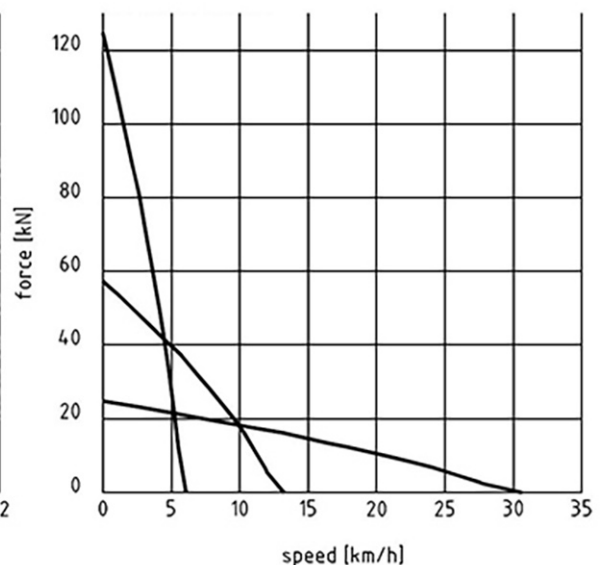

Normet reserves the right to change this specification without further notice

Pictures may include options and additional equipment.

CUMMINS B 4.5 121 KW

Performance curve with lock-up DOC028557

Conversion chart

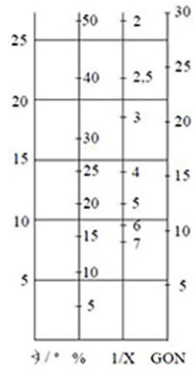

Gradeability kN

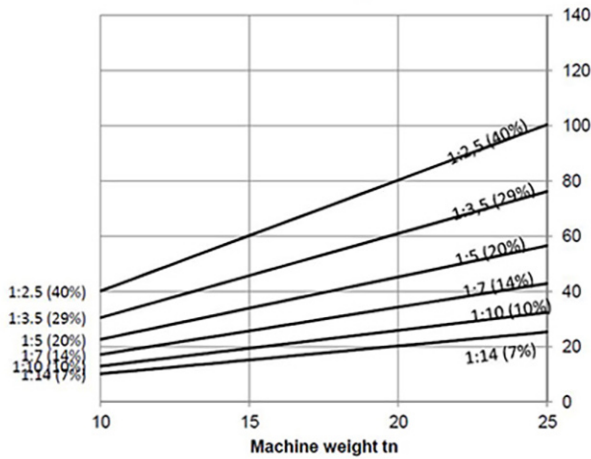

Tractive effort kN

