

Cheers!

Bar-quality drinks
at the push of a button.

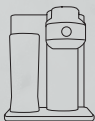

DRINKWORKS®
by KEURIG



HOME BAR CLASSIC
CARE GUIDE

Welcome.

We recommend that you review and carefully follow this guide as well as all warnings and instructions that accompany your Home Bar® Classic to make the most of your Drinkworks® experience. This guide includes use, care, maintenance and troubleshooting information to help you make remarkable drinks every time.

Contents.

Home Bar warnings	i
Carbonation warnings	ii
Electrical warnings	iii
Allergy warnings	iv
Home Bar components	02
Using your Home Bar	03
<i>Positioning the Home Bar</i>	03
<i>Filling the water tank</i>	03
<i>Making a drink</i>	04
<i>Drinkworks app and Wi-Fi pairing</i>	08
Home Bar controls and indicators	09
Home Bar care and cleaning	10
Storage	16
CO ₂ cartridge care and replacement	16
START button indicators	20
Troubleshooting	21
Helpful hints	24
Home Bar warranty	25

Home Bar warnings.

Read and follow all warnings and instructions before use. Misuse of the Home Bar may result in serious personal injury or property damage.

Positioning

Set up the Home Bar on a flat, weight-bearing, stable, heat-resistant surface away from hot surfaces, sources of heat or open flames.

Keep out of reach of children.

Keep upright. Do not use the Home Bar unless it is in its upright position.

Use

Use only with Drinkworks Pods. Use with any other Pod may result in injury or damage to the appliance.

Use only ice and water in the Home Bar. Do not put any other liquids or substances in the water tank except as instructed in the cleaning instructions starting on page 10.

Do not overfill the water tank.

Do not move the Home Bar during the drink-making process.

Keep Home Bar operating temperature between 41°F and 86°F (5°C and 30°C).

You must be 21 years or older to purchase or consume alcoholic beverages.

Care

Perform maintenance only as directed in the Home Bar Classic Care Guide.

Any servicing other than cleaning and user maintenance should be performed by an authorized Drinkworks representative.

Attempting other maintenance or servicing could cause injury or damage.



Disposal

The symbol on the product or its packaging indicates: Do not dispose of electrical appliances or batteries as unsorted municipal waste; use separate collection facilities.

Contact your local authority for information regarding the collection systems available. If electrical appliances are disposed of in landfills or dumps, hazardous substances can leak into the groundwater and get into the food chain, damaging your health and well-being.

Contact your local or regional waste authority for more information on collection, reuse and recycling programs.

Carbonation warnings.

The Home Bar system utilizes carbon dioxide (CO₂) gas under pressure. Do not puncture the CO₂ cartridge or expose to heat, fire or flames.

Keep out of reach of children. Close supervision is necessary when the Home Bar is being used near children.

Handling

Mishandling the CO₂ cartridge can result in serious personal injury.

Do not throw or drop the CO₂ cartridge or allow it to fall.

Do not tamper with the CO₂ cartridge in any way.

Do not transport the Home Bar with the CO₂ cartridge installed.

Do not heat the CO₂ cartridge or leave in direct sunlight.

Do not inhale CO₂.

Store the CO₂ cartridge in a well-ventilated, cool, dry place (max 50°C/122°F).

Do not handle the CO₂ cartridge while CO₂ is discharging. CO₂ cartridge will be extremely cold and could freeze tissue. Allow the CO₂ cartridge to warm up to room temperature before handling.

Carbonation

Do not allow children to use the Home Bar.

Use only authorized Drinkworks CO₂ cartridges. Use of non-authorized CO₂ cartridges could lead to serious injury or damage.

Do not remove the CO₂ cartridge from the machine until all CO₂ has been discharged from the cartridge.

Removing the CO₂ cartridge before discharging all CO₂ could cause injury.

Use

Inspect the CO₂ cartridge before use for dents, punctures or other damage.

If you see any damage, do not use the cartridge; instead, contact a Drinkworks representative.

Do not open the CO₂ door while the Home Bar is preparing a drink.

End of life

Do not attempt to refill an empty CO₂ cartridge. The cartridges are not refillable.

Electrical warnings.

When using any electrical appliance, basic safety precautions should be followed, including the following:

General

Read all instructions before using.

The Home Bar must be properly installed and positioned in accordance with these instructions before it is used.

Clean Home Bar components as specified in this guide.

Always keep the water tank cap on the water tank, unless you are refilling it.

Do not attempt to lift the Home Bar handle while making a drink.

To protect against fire, electrical shock and injury, do not immerse cords, plugs or the Home Bar in water or other liquids.

Do not use the Home Bar for anything other than its intended use.

The use of non-authorized accessories may cause injury and/or damage the Home Bar.

Positioning

Do not place the Home Bar on or near a hot gas or electric burner, or in a heated oven.

Keep the Home Bar away from direct sunlight and heat sources.

Do not use outdoors. The Home Bar is intended for indoor use only.

Do not let the cord hang over the edge of a table or counter, or touch hot surfaces.

Use of accessory attachments is not recommended by the manufacturer and may result in fire, electrical shock or injury.

Power adapter plug

Each Home Bar is shipped with a tested power adapter that is authorized for use with the appliance.

Use of any other adapter can potentially damage or cause a safety risk with the product.



External cleaning

It is recommended that Home Bar is unplugged while cleaning the exterior.

THIS PRODUCT IS FOR
HOUSEHOLD USE ONLY.



Allergy warnings.

Some beverage Pods may contain allergens such as milk, egg, wheat, nuts or soy, or have been produced in a facility that also produces products containing milk, egg, wheat, nuts or soy. Check the Pod packaging for allergen information. If you make a drink with such a Pod, remove the Pod basket and clean it before your next drink, as there may be trace amounts of allergen on the basket.

Questions, comments, concerns?

For additional help, reach out to our Top Shelf Service Team by phone, email or chat:

1-855-DRINKWORKS (1-855-374-6596)

hello@drinkworks.com

To access the chat function, go to drinkworks.com and click on the chat icon in the lower right corner.

Home Bar components.

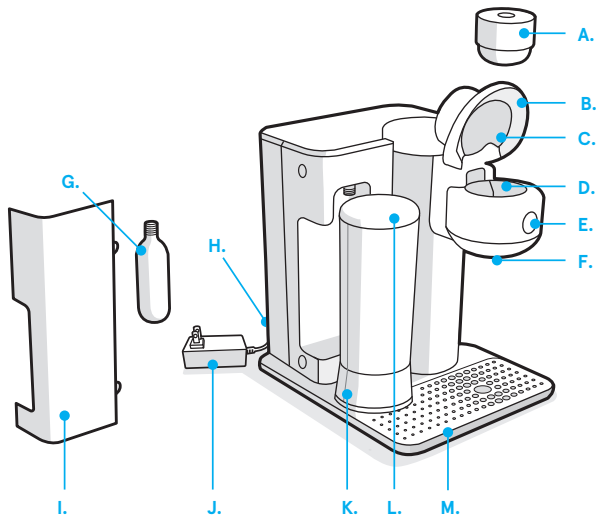

A. Drinkworks Pod
(Not included)

B. Handle

C. Pod Door

D. Pod Basket

E. START Button

F. Tap

G. CO₂ Cartridge

H. Power Button

I. CO₂ Side Door

J. Power Cord

K. Water Tank

L. Water Tank Cap

M. Drip Tray

Using your Home Bar.

Follow the below best practices for setting up your Home Bar, filling the water tank, making drinks and connecting to Wi-Fi via the Drinkworks app.

Positioning the Home Bar

Place your Home Bar in an open, uncluttered area in your kitchen or bar area.

We recommend that you always keep your Home Bar plugged in.

Do not place the Home Bar on or near a hot gas or electric burner, or in a heated oven.

Keep the Home Bar away from direct sunlight and heat sources.

Do not use outdoors. The Home Bar is intended for indoor use only.

Do not let the cord hang over the edge of a table or counter, or touch hot surfaces.

Filling the water tank

Always remove the water tank from the Home Bar when filling with ice or water. Do not bring the appliance to the sink to refill the water tank.

Do not overfill the water tank.

Using bottled or filtered water is recommended, but optional.

Always empty leftover water in the water tank from a previous day's use. Refill with fresh ice and cold water for best performance.

Fill the water tank with ice and water only, except as otherwise instructed during a Clean Cycle.

Using your Home Bar.

Making a drink

- 1a.** Remove the water tank cap and fill water tank with ice. When making only one drink, fill with ice to the lower line. Otherwise, fill with ice to the top line.

Tip: Always empty leftover water in the water tank from a previous day's use. Refill with fresh ice and cold water for best performance.

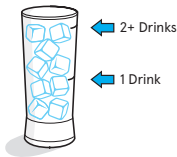

- 1b.** Add just enough cold water to cover the ice.

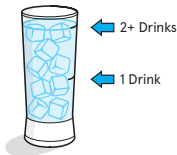

- 1c.** Place the cap back on the water tank, making sure it is pressed all the way down. With one hand on the cap, shake the water tank to get the water ice cold. For best results, shake for at least 30 seconds. Place the water tank back on the Home Bar.

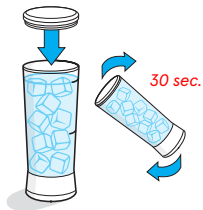

- Lift up the handle on the Pod door to reveal the Pod basket.



- Place a Drinkworks Pod in the Pod basket. Make sure the Pod is fully inserted, with the bar code on the Pod label at a 12 o'clock position (i.e., facing away from you and with the name of the drink facing forward).

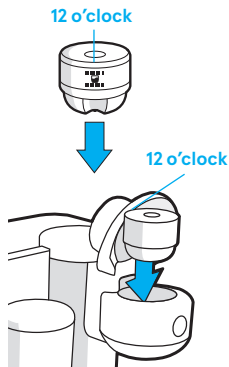

4. Close the Pod door and wait for the Home Bar to recognize your drink and prepare its recipe. The START button will flash blue if the Pod is inserted correctly.

If the Home Bar does not recognize the Pod, see troubleshooting tips on page 21.

Tip: If you do not push the START button within 60 seconds, the light will stop flashing blue. If you still want to make your drink, reload the recipe by opening and closing the Pod door using the handle.

If the Home Bar doesn't recognize the Pod, the START button will flash blue, red and purple. See page 21 or open the Drinkworks app for help.

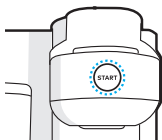
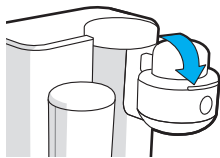

5. Place the appropriate size of glass underneath the tap on top of the drip tray and press the START button.

Tip: Serving suggestions for each drink—including glassware, garnish and ice recommendations—can be found on the Pod packaging, in the Drinkworks app and at [drinkworks.com](https://www.drinkworks.com).

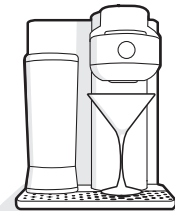

6. The START button will pulse **BLUE** as the drink is being made. Your drink is ready to enjoy when the START button turns solid **BLUE**. Please enjoy responsibly!

Tip: It is recommended that you remove the empty Pod from the Pod basket after your drink has been made.

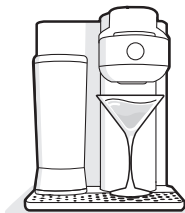

Using your Home Bar.

Drinkworks app and Wi-Fi pairing

Your Home Bar comes with built-in Wi-Fi technology. This technology allows your Home Bar to communicate with the Drinkworks app about its performance in order to help us improve its function. Once your Home Bar is connected to the Drinkworks app, you will have a choice to opt in to share Home Bar data with Drinkworks for these and other purposes described during the opt-in process. This feature is optional. It is not required for the Home Bar to function properly.

Download the Drinkworks app from the Apple App Store or Google Play Store and connect to your Home Bar to enjoy all of its features.

After downloading the Drinkworks app, you can choose to get connected to your Home Bar with the following steps:

1. Enable the Wi-Fi feature on your phone through its settings.
2. Create an account on the Drinkworks app and then follow the instructions in the app.

Use the Drinkworks app to:

- Get step-by-step Home Bar setup instructions.
- Register your Home Bar.
- Get firmware updates.
- Learn Home Bar management tips.
- Optimize your drink-making experience.
- Get one-click access to our Top Shelf Service Team.
- Discover exclusive promotions.

And much more!

Tip: We make software enhancements on a regular basis—connect your Home Bar to get automatic updates and keep your machine running efficiently.

For more information, visit drinkworks.com.

Home Bar controls and indicators.

Water tank indicator

Your Home Bar has a light under the water tank that will flash white as a reminder to add more water.



CO₂ indicator light

The CO₂ indicator light will flash red when the Home Bar is out of CO₂.



STARTbutton

Press START to confirm an action or select an option.

See START button indicators on page 20.



Home Bar care and cleaning.

Cleaning the Home Bar exterior

Keep your Home Bar looking its best by cleaning the exterior after making drinks. Wipe down the surface with a clean, moist, lint-free, non-abrasive cloth. Never immerse the Home Bar in water or other liquids.

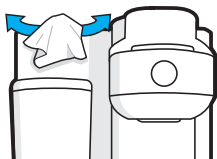

Cleaning the drip tray

The drip tray can accumulate up to 8 ounces of liquid before it overflows. To remove the drip tray, slide it toward you, keeping it level at all times to avoid spilling its contents. The drip tray should occasionally be rinsed between cleanings. Clean the drip tray with a damp, soapy, lint-free, non-abrasive cloth.

Drip tray is not dishwasher-safe.

Cleaning the Pod basket

Wash the Pod basket at least once a week, and a quick rinse after each drink is recommended—especially if you're concerned about allergens. The Pod basket is removable and can be cleaned with a damp, soapy, lint-free, non-abrasive cloth or in the top rack of the dishwasher. Keeping the Pod basket clean helps maintain drink quality.

***WARNING:** Some beverage Pods may contain allergens such as milk, egg, wheat, nuts or soy, or have been produced in a facility that also produces products containing milk, egg, wheat, nuts or soy. Check the Pod packaging for allergen information. If you make a drink with such a Pod, remove the Pod Basket and clean it before your next drink, as there may be trace amounts of allergen on the basket.

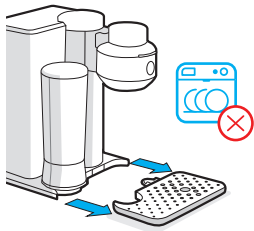

Cleaning the water tank and water tank cap

The water tank and water tank cap should be periodically inspected and cleaned. Neither part should be cleaned in the dishwasher but rather with a damp, soapy, lint-free, non-abrasive cloth, and then rinsed thoroughly.

Do not dry the inside of the water tank with a cloth, as lint or other particles may transfer from the cloth to the tank.

To clean the filter screen at the base of the water tank, empty the tank and follow one or both of the following procedures:

- Fill the water tank with approximately 2 inches of clean water, put the cap on and shake vigorously.
- Empty the water tank, then fill it with clean water and return it to the Home Bar.

If needed, repeat the above procedures.

Tip: Rinse the water tank thoroughly after cleaning so that no cleaners or cleaning solutions remain in this area, as they may contaminate the water supply in the Home Bar.

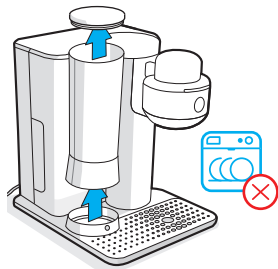

Running the Rinse Cycle

Periodically run the Rinse Cycle to run fresh water through your Home Bar internals. To run a Rinse Cycle, start by rinsing and filling the water tank with clean water. Then place an empty half-gallon container under the tap. Next, **press and hold** the START button for 10 seconds. Release the START button when it flashes purple. Now **press and hold** the START button while the machine draws in and dispenses the water. When you are done, release the START button and the Home Bar will purge the remaining water inside and your rinse will be complete.

Make sure to keep the Pod basket in the Home Bar while running a Rinse Cycle.

Tip: Run a Rinse Cycle with ice-cold water to pre-chill the inside of your Home Bar and get your drinks extra cold!

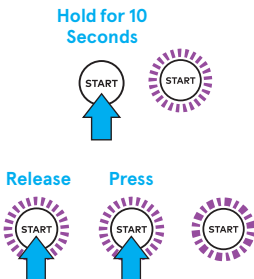

Running the Clean Cycle

The Clean Cycle is a two-phase process. In the first phase, you will rinse your Home Bar with cleaning solution (in the form of a Drinkworks cleaning tablet). In the second phase, you will rinse your Home Bar with clean water.

To run a Clean Cycle, you will need about 10 minutes, one Drinkworks cleaning tablet and a container that can hold at least a half-gallon of water to place under the tap.

It is recommended to run a Clean Cycle every 2 weeks.

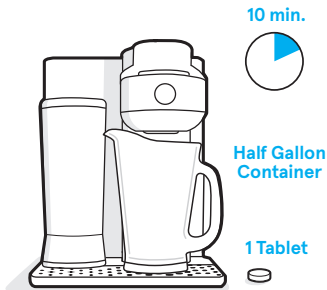

Once you have started the Clean Cycle, you must finish it. There is no way to pause or cancel. However, if you accidentally initiate a Clean Cycle by holding the START button for 10 seconds, simply open and close the Pod door to reset—or do nothing and wait 60 seconds.

1. Remove and rinse the water tank. Fill to the lower line marked on the tank (about halfway) with fresh warm water and place it back on the Home Bar.

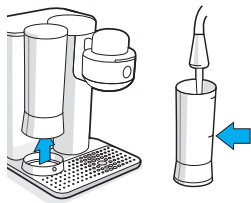

2. Add one Drinkworks cleaning tablet to the water tank and wait for it to fully dissolve (about 10 minutes).

Tip: Your Home Bar purchase includes six cleaning tablets. Additional tablets can be purchased on [drinkworks.com](https://www.drinkworks.com) and at select retailers that carry Drinkworks products.

3. Place an empty half-gallon container under the tap.

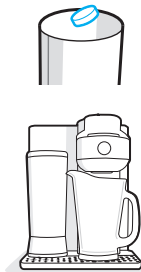

Make sure to keep the Pod basket in the Home Bar while running a Clean Cycle.

4. When the tablet is fully dissolved, **press and hold** the START button for 10 seconds until the water tank light turns on and the START button flashes purple.

Make sure you have an empty half-gallon container under the tap.

Hold for 10
Seconds



5. Release and press the START button again to begin the Clean Cycle. The START button will pulse purple while pulling in the water from the tank. If you run out of water, the tank light will flash. Fill with more water, about halfway to the lower line.

Release

Press



6. After 60 seconds, the START button will begin flashing again when it is ready to empty the cleaning solution and start the Rinse Cycle.



7. Once the water has been dispensed, fill the water tank to the top with clean water. Return the water tank to the top of the Home Bar and press START.

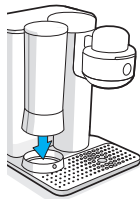

8. The Home Bar will empty any remaining cleaning solution from inside, refill it with clean water, soak for 60sec, and automatically empty the internal water as well as remaining water in the external water tank.



9. When the indicator lights turn off, the Home Bar has completed the Clean Cycle. Empty, dry and store your half-gallon container and refill the water tank with ice and cold water to start making drinks!

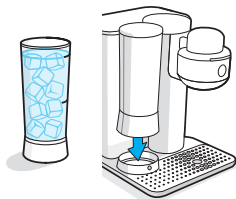

Storage.

Before you store your appliance for an extended time, make sure to do the following:

1. Run a Clean Cycle.
2. Remove the CO₂ cartridge. See removal instructions on page 17.
3. Rinse, empty and dry the water tank, Pod basket and drip tray.
4. Store your Home Bar upright in a safe, frost-free environment.

When you prepare to use your Home Bar after storage, we recommend rinsing the water tank with clean water and running a Clean Cycle before making drinks.

Tip: Instructional videos are available on the Drinkworks app and you can watch step-by-step videos on cleaning, rinsing and more at drinkworks.com.

CO₂ cartridge care and replacement.

Read and follow all warnings and instructions before using the Drinkworks Home Bar Classic. It is the owner's responsibility to ensure that all users are aware of all warnings and precautions.

Use only Drinkworks CO₂ cartridges with the Home Bar.

Always handle CO₂ cartridges with care.

Cartridges are not a toy and are not intended for use by pets or anyone under the age of 18.

WARNING: Drinkworks CO₂ cartridges contain gas under pressure; may explode if heated. Protect from sunlight. Store in a well-ventilated place. Do not inhale. Do not drop. Do not use if damaged. Do not tamper with or modify in any way. Empty cartridge before recycling or disposal. Cartridges are not refillable.

The carbonation system is pressurized, and cartridges can become very cold when discharging gas. Do not touch the cartridge with bare skin during or immediately after discharging CO₂. Wait for the cartridge to return to room temperature before handling. Refer to the carbonation warnings on page ii or visit drinkworks.com for more information.

The CO₂ indicator light will flash red when the cartridge is out of CO₂ and needs to be replaced.

Drinkworks CO₂ cartridge removal

1. To remove CO₂ door, remove the water tank and place it off to the side. Place one hand in the groove of the CO₂ door on the left side of the Home Bar. Slide the door to the left, away from the appliance.
2. Pull the CO₂ cartridge up and away from the Home Bar until it is sticking out at a 45-degree angle.
3. Hold the cartridge up at 45 degrees and slowly unscrew. If you hear gas releasing, stop unscrewing the cartridge and wait for all the gas to release and the cartridge to return to room temperature. Once the cartridge returns to room temperature, finish unscrewing it from the Home Bar until you can remove the empty cartridge.
4. Dispose of the empty CO₂ cartridge. See disposal instructions on page 19.

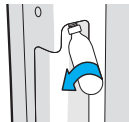
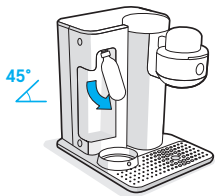
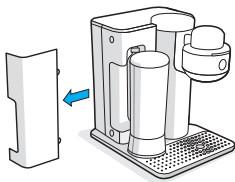

Drinkworks CO₂ cartridge installation

1. Insert a full CO₂ cartridge at a 45-degree angle into the receiving end on the Home Bar. (If the receiving end on the Home Bar is in the vertical position, pull it away from the appliance so that it is at a 45-degree angle.) While holding the cartridge at a 45-degree angle, screw in until the cartridge is tight and not leaking. If you hear gas leaking, immediately tighten the cartridge by screwing it in until the leaking stops. It is important to get a tight seal and twist past the "hiss" you might hear.

WARNING: The CO₂ cartridge will get colder over time if it is leaking CO₂. Do not touch the cartridge with bare skin while it is leaking.

WARNING: Beware of sharp needle. Do not put fingers into chamber where the cartridge screws in.



2. Push down on the cartridge firmly until it locks into place. The cartridge should be completely straight (vertical) when in the correct position.

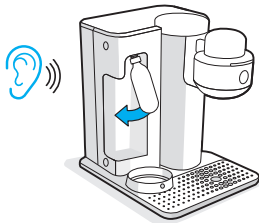

3. Replace the CO₂ door. Align the door into the grooves and slide back into place.

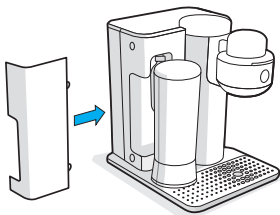

4. You're ready to make carbonated drinks!

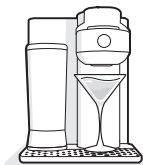

Tutorials and tips

For tutorials and tips on installing the CO₂ cartridge, as well as information on where and how to purchase more cartridges, visit drinkworks.com or download the Drinkworks app.

Disposal

The Drinkworks CO₂ cartridge is a multi-serve, single-use cartridge. Do not attempt to refill or tamper with it in any way.

The CO₂ cartridge is recyclable when empty. As long as the cartridge has been used in the Home Bar, it will be fully empty. Please recycle.

For more information, visit drinkworks.com.



START button indicators.

Use the guide below to determine what the colored ring around the START button says about your Home Bar status.



Unlit

The Home Bar is off or in standby mode. To wake up from standby mode, simply press the START button or lift the handle on the Pod door.



Solid Blue

The Home Bar is awake and in standby mode.



Flashing Blue

Press the START button to make your drink.



Pulsing Blue

The Home Bar is making a drink.



Flashing Red

The Home Bar needs to empty and start over. Place an empty half-gallon container under the tap and press START.



Solid Red

A more serious error has occurred. See troubleshooting tips on page 21. If you need further assistance, call **1-855-DRINKWORKS (1-855-374-6596)**.



Rapid Flashing Purple

The Home Bar is updating software. Please wait until it is complete.

Flashing between:



Purple and Blue

The Home Bar is ready to pair for Wi-Fi setup.



Blue, Red and Purple

Pod reader error. See troubleshooting tips on page 21.



CO₂ Light:

Flashing Red

Add more CO₂ if the cartridge is cold, use a paper towel to remove or wait until it returns to room temperature.



Water Tank Light:

Flashing

Add ice and water. Return tank to the base and press START. Do not open the Pod door.

Troubleshooting.

For easy access to the best Home Bar troubleshooting tips, download the Drinkworks app for your iOS or Android device and enable push notifications. The app will immediately notify you of an error and guide you through the steps to fix it.

To ensure quality and consistency, look for this mark on your Pod bar code to confirm it is an authentic Drinkworks Pod.

What do I do if...

My Home Bar does not recognize a Pod?

Tip: If your Pod is not recognized, open the app for step-by-step help.

If your Home Bar fails to recognize an authentic Drinkworks Pod, open the Pod door and re-insert the Pod. Make sure the bar code is at a 12 o'clock position and the Pod basket is fully seated. After two failed attempts to determine the type of Drinkworks Pod, the Home Bar will enter an override state. The START button will flash blue, red and purple.

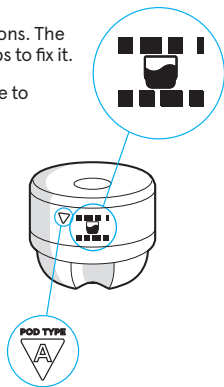

Follow the instructions below to make your drink:

1. Open the Pod door by lifting up the handle and remove the Pod.
2. Find the Drinkworks Pod type printed on the Pod label. It will be a capital letter located in a triangle under "Pod type."
3. Re-insert the Pod and close the Pod door.
4. The START button will flash blue, red and purple.
5. Press the START button the corresponding number of times for the Pod type: A=1, B=2, C=3, D=4, E=5, F=6, G=7. For example, if you have a C type Pod, press START three times.
6. The CO₂ indicator light will flash the same number of times as you pressed the START button to confirm your Pod letter choice. If this is correct, **press and hold** the START button until it flashes blue to accept the recipe.
7. Finally, press START one last time to make your drink!

What do I do if...

My Home Bar does not have power?

- Make sure it is plugged in securely.
- Confirm you have the power cord that came with your Home Bar and plug it into an independent outlet and/or a different outlet.
- Reset your home's circuit breaker, if necessary.
- If you continue to have trouble, contact our Top Shelf Service Team at **1-855-DRINKWORKS (1-855-374-6596)**.

My Home Bar will not make a non-carbonated drink?

- After placing a Pod in the Pod basket, make sure the Pod door is all the way down and the blue button is flashing. If the Home Bar does not recognize the Pod, follow the steps under **"My Home Bar does not recognize a Pod"** on page 21.
- If the water tank light is flashing, add ice and water. Fill to, and not beyond, the top line. Also, make sure the water tank is seated properly on its base.
- If the START button is flashing red, follow the steps under **"The START button is flashing red"** on page 23.
- If you continue to have trouble, contact our Top Shelf Service Team at **1-855-DRINKWORKS (1-855-374-6596)**.

My Home Bar will not make a carbonated drink?

- Follow the steps above under **"My Home Bar will not make a non-carbonated drink."**
- Additionally, if the CO₂ indicator light is red, replace the CO₂ cartridge.
- If you continue to have trouble, contact our Top Shelf Service Team at **1-855-DRINKWORKS (1-855-374-6596)**.

What do I do if...

The START button is flashing red?

The START button will flash red when it has encountered an error during the drink-making process. The Home Bar will need to recover by draining the water that is inside. This is to ensure that every drink you make meets the high-quality standards of Drinkworks and that you never waste a Pod. Place an empty glass underneath the tap to capture any water that is dispensed, and press START.

The START button is solid red?

The Home Bar has encountered a critical error. Contact our Top Shelf Service Team at **1-855-DRINKWORKS (1-855-374-6596)**.

Helpful hints.

Tips and tricks every Home Bar owner should know.

Add ice to the water tank

Always start your drink-making experience by filling the water tank with ice, *then* water. Be sure to shake the water tank to get the coldest water possible—especially for carbonated drinks.

Use bottled or filtered water

Water quality varies from place to place. If you notice an undesirable taste in your drinks (such as chlorine or other mineral tastes), try using bottled water or water from a filtration system. For best results, follow the manufacturer's instructions when using any water filtration system.

Empty the water tank after use

When you are done making drinks for the day or night, empty and rinse the water tank so it's ready for fresh ice and water the next time.

Use caution with CO₂ cartridges

When you remove a CO₂ cartridge, it may be very cold. Use a paper towel or wait until it returns to room temperature.

Remove Pods after use

Do not leave empty Pods in the Home Bar Pod basket. Remove the Pod after your drink has been made.

Clean the Pod basket weekly

Remove the Pod basket once a week and hand-wash it or clean it in the top rack of the dishwasher.

Run a Clean Cycle every 90 days

Use cleaning tablets to keep your Home Bar running smoothly. See page 12 for instructions.

Stay stocked on your favorite Pods

Not sure where to buy Pods? Go to the Pod Locator on [drinkworks.com](https://www.drinkworks.com) to find convenient local and online options.

Download the app

For more ways to get the most out of your Home Bar, download the Drinkworks app.

Home Bar warranty.

Drinkworks Home Bar will be free of defects in materials or workmanship under normal home use for one (1) year from the date of purchase. We recommend that you register your Home Bar by visiting drinkworks.com/register, downloading and syncing the Drinkworks app with your iOS or Android device, or calling toll-free **1-855-DRINKWORKS (1-855-374-6596)** so that your purchase information will be stored in our system.

Drinkworks will, at its option, repair or replace a defective Home Bar without charge upon its receipt of proof of the date of purchase. If Drinkworks opts to replace your Home Bar to service this warranty, the replacement appliance may be new or reconditioned. If you receive a replacement Home Bar, your existing warranty end date will be applied to the replacement.

This warranty applies only to Home Bars operated in the United States and Canada. This warranty gives you specific legal rights, and you may also have other rights that vary from state to state or, in the case of Canada, from province to province. We can only

guarantee the proper functioning and lifetime of your Home Bar if you use Drinkworks Pods and accessories.

Any damage to or malfunction of your Home Bar resulting from the use of non-Drinkworks Pods or accessories may not be covered by this warranty or may result in a service fee if the damage or malfunction is determined to be caused by such use.

For information on ongoing maintenance and how to keep your Home Bar functioning properly, refer to the Home Bar Classic Care Guide or visit drinkworks.com.

Contains FCC ID: 2AC7Z-ESP32WROVERE

This device complies with Part 15 of the FCC Rules. Operation is subject to the following two conditions: (1) this device may not cause harmful interference, and (2) this device must accept any interference received, including interference "that may cause undesired operation."

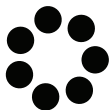

DRINKWORKS[®]
by **KEURIG**

Contact us.

Questions or suggestions?

We'd love to hear from you!

1-855-DRINKWORKS (1-855-374-6596)

hello@drinkworks.com

Follow us for updates on all things Drinkworks:



Drinkworks Pods, CO₂ cartridges and other available accessories are sold separately.
This Home Bar is designed to prepare alcohol beverages and is intended for use by persons 21+ years old.
Please enjoy responsibly.

DRINKWORKS, HOME BAR and logo are the property of Bedford Systems LLC. All third-party trademarks or logos referenced in this guide are the property of their respective owners.
KEURIG[®] is a trademark of Keurig Green Mountain, Inc., used under license.