

Marshall

STANMORE II VOICE WITH AMAZON ALEXA

USER MANUAL

LEGAL & TRADEMARK NOTICE

- Design of device and packaging are intellectual properties of Zound Industries International AB and Marshall Amplification Plc. © All Rights Reserved. Zound Industries International AB is hereinafter referred to as “Zound Industries” or “manufacturer”.
- MARSHALL, Marshall Amps, their respective logos, “Marshall” and “Marshall” trade dress are trademarks and intellectual property of Marshall Amplification Plc and may not be used without permission. Permission granted to Zound Industries.
- Wi-Fi®, the Wi-Fi logo and the Wi-Fi CERTIFIED™ logo is a certification mark of Wi-Fi Alliance®.
- The Bluetooth® wordmark and logos are registered trademarks owned by the Bluetooth SIG, Inc. and any use of such marks by Zound Industries is under license.
- Google, Google Play and their respective logos are trademarks of Google LLC.
- Apple and the Apple logo are trademarks of Apple Inc. registered in the U.S. and other countries. App Store is a service mark of Apple Inc., registered in the U.S. and other countries.
- Amazon, Alexa and all related logos are trademarks of Amazon.com, Inc. or its affiliates.
- Spotify® and Spotify Connect logos™ are trademarks of the Spotify Group, registered in the U.S. and other countries. The Spotify Software is subject to third party licenses found here: www.spotify.com/connect/third-party-licenses.
- All other trademarks are the property of their respective owners and may not be used without permission.

For more legal information related to this product and to its use in your specific region, and for more detailed information about Zound Industries and partner & license information, please visit the website: www.marshallheadphones.com. The user is recommended to visit the website regularly for up-to-date information.

Zound Industries International AB, Centralplan 15, 111 20 Stockholm, Sweden

DISCLAIMER

Please note that the availability of third party services, including but not limited to Spotify, Alexa, and this device's compatibility with the same, is subject to the respective rights holder's consent, which may be withdrawn, and supply of such services, which may be terminated, resulting in this device not being compatible with such third-party services, without any liabilities for Zound Industries.

The availability of third party services may need separate agreements between you and any third party and Zound Industries do not take responsibility for the availability of such services.

INDEX

ENGLISH

SECTIONS

PAGE

- 002. LEGAL & TRADEMARK NOTICE**
- 004. BOX CONTENTS**
- 005. GENERAL DESCRIPTION**
- 007. PLUGGING IN THE STANMORE II VOICE**
- 008. SETTING UP THE STANMORE II VOICE**
- 009. USING AMAZON ALEXA**
- 010. SELECTING AUDIO SOURCE**
- 011. USING STANMORE II VOICE WITH SPOTIFY CONNECT®**
- 012. CONNECTING VIA BLUETOOTH® (PAIRING)**
- 013. CONNECTING VIA AUX INPUT**
- 014. CONNECTING VIA RCA INPUT**
- 015. ADJUSTING THE VOLUME/BASS/TREBLE**
- 016. PLAY/PAUSE CONTROL**
- 017. MUTING/UNMUTING THE MICROPHONE**
- 018. TECHNICAL INFORMATION**
- 019. TROUBLESHOOTING**

BOX CONTENTS

- 001. MARSHALL STANMORE II VOICE WITH AMAZON ALEXA**
- 002. QUICK START GUIDE**
- 003. IMPORTANT SAFETY INSTRUCTIONS**
- 004. MAINS LEAD**

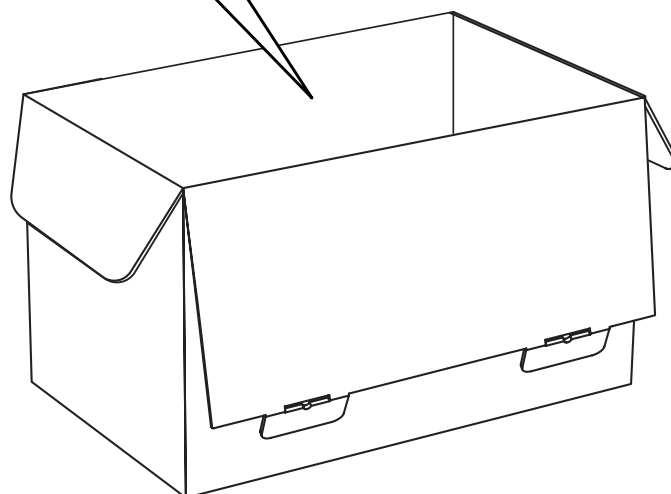
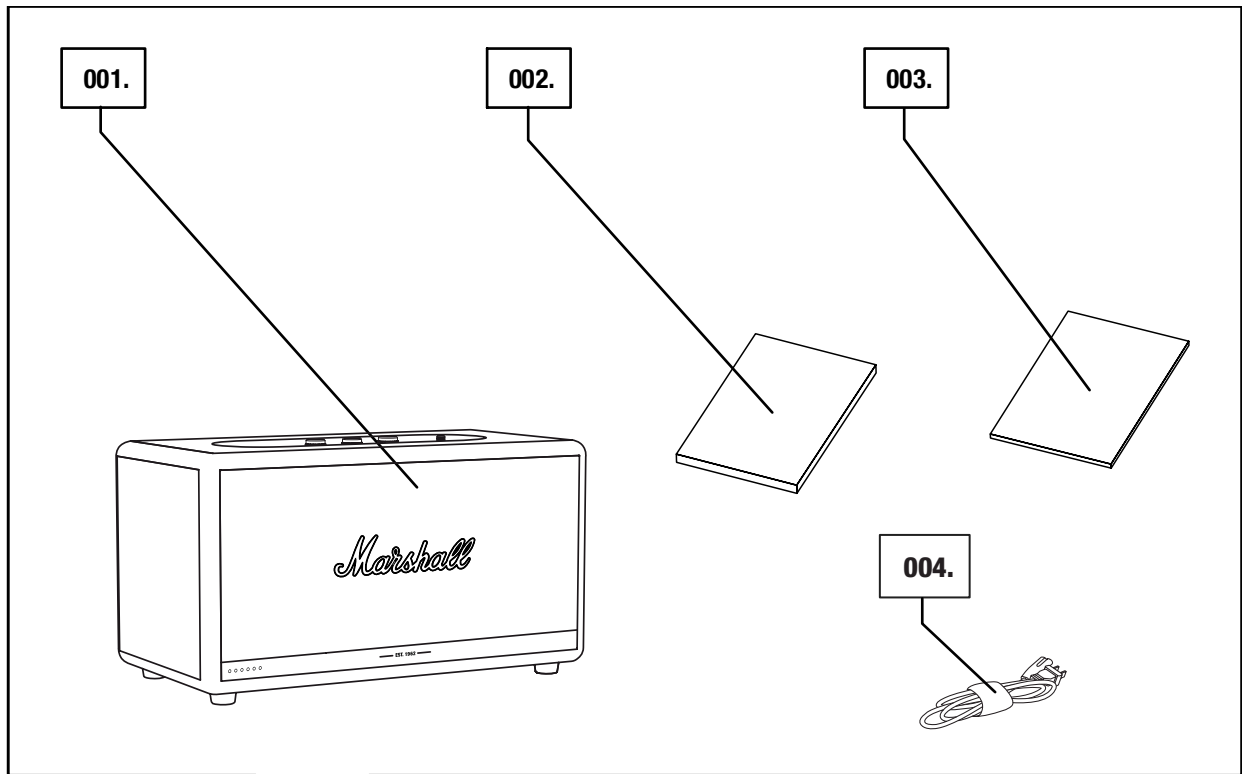

GENERAL DESCRIPTION

- 001. AUX INPUT FOR 3.5 mm JACK
- 002. SOURCE INDICATORS
- 003. SOURCE BUTTON
- 004. VOLUME KNOB
- 005. BASS KNOB
- 006. TREBLE KNOB
- 007. MICROPHONES
- 008. PLAY/PAUSE BUTTON
- 009. MICROPHONE BUTTON

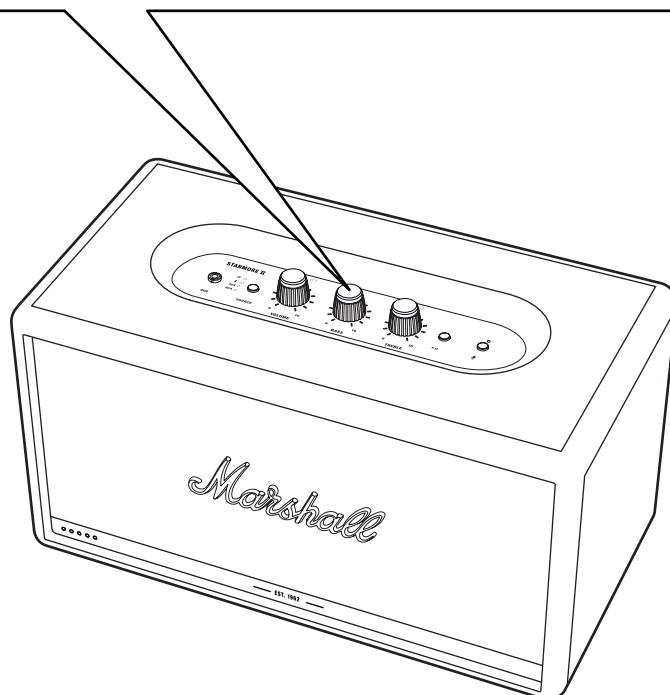
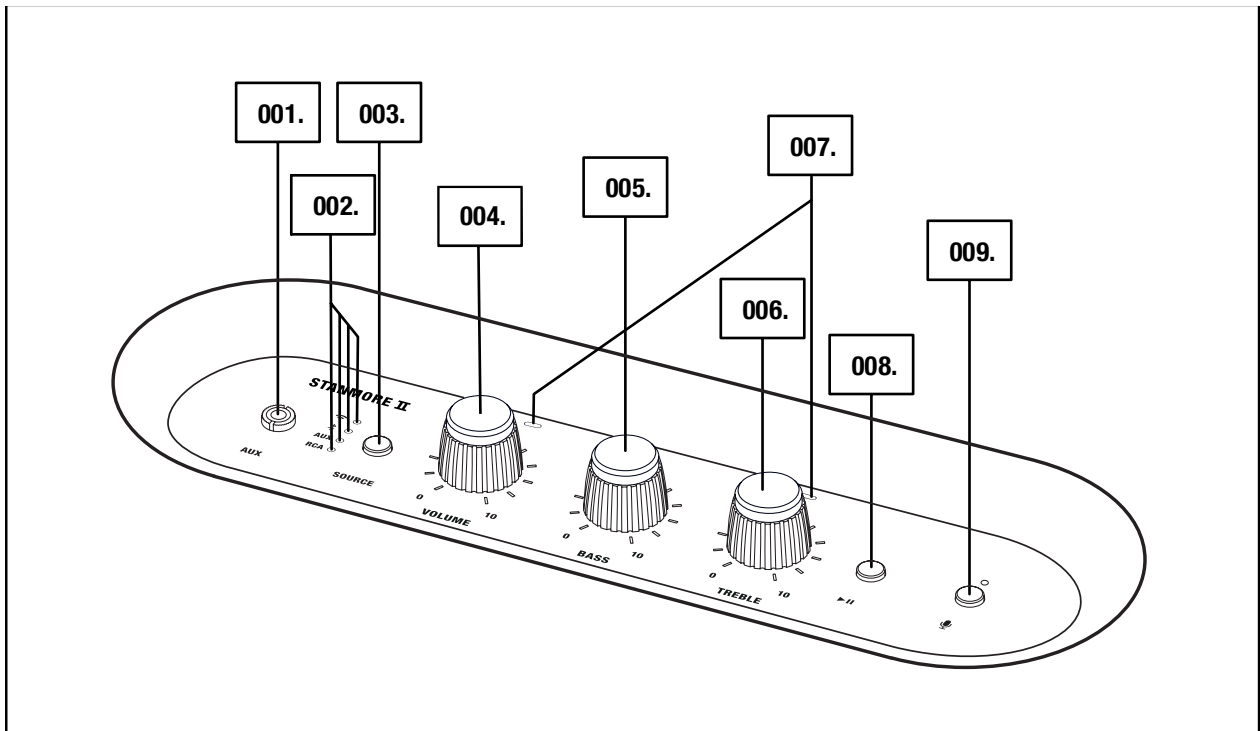

005.

Marshall

GENERAL DESCRIPTION CONTINUED

- 009. BASS PORT
- 010. BACKPLATE
- 011. USB (NOT USED)
- 012. RCA INPUT (LEFT AND RIGHT)
- 013. MAINS INPUT
- 014. MAINS LEAD

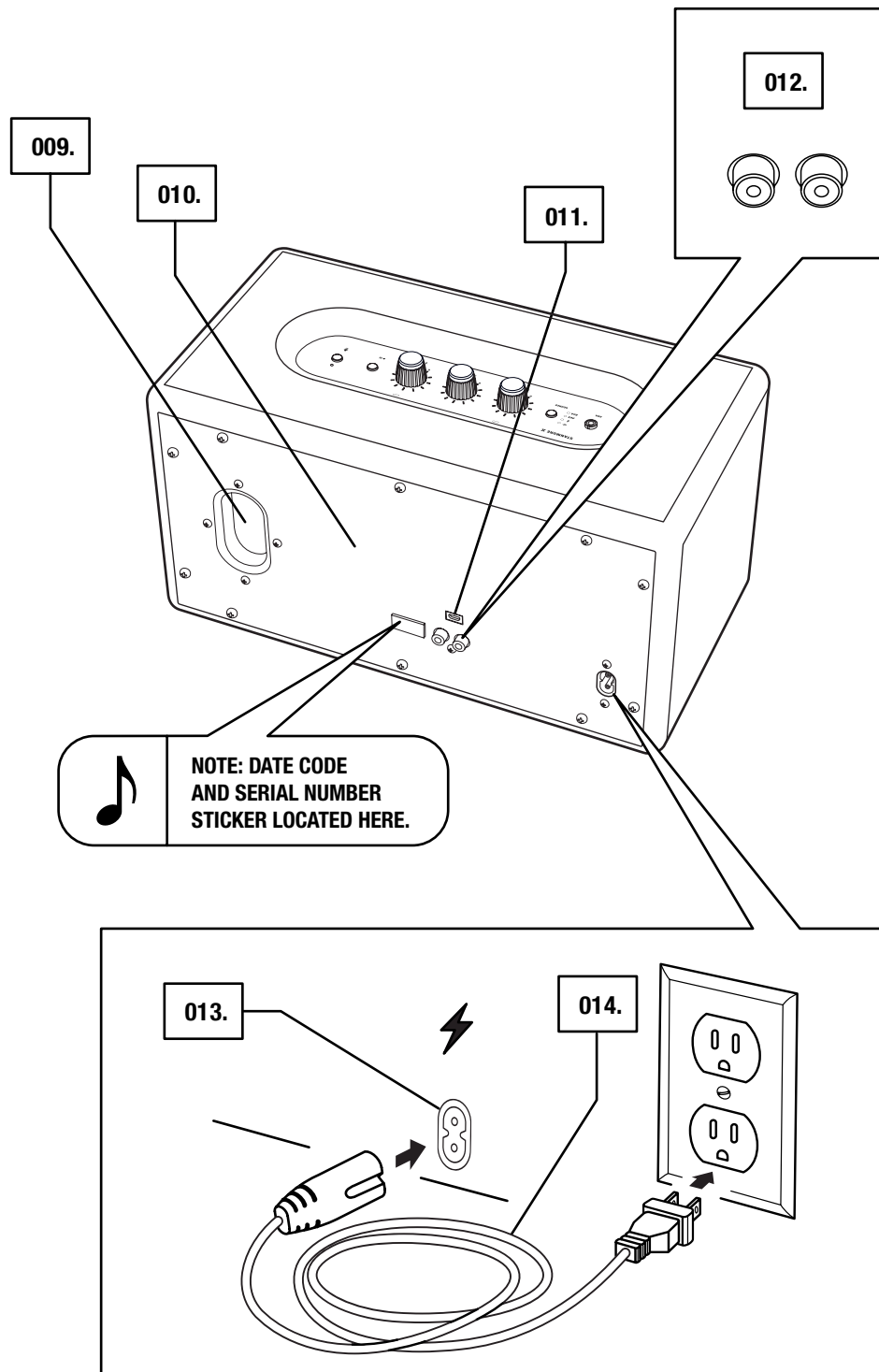

PLUGGING IN THE STANMORE II VOICE

IMPORTANT: ALWAYS ENSURE THAT THE MAINS LEAD, POWER JACK AND SPEAKER ARE COMPATIBLE WITH YOUR MAINS SUPPLY AND WALL SOCKET.

- 001. CONNECT THE MAINS LEAD INTO THE MAINS INPUT ON THE SPEAKER.**
- 002. CONNECT THE POWER JACK TO THE WALL SOCKET.**



CAUTION: ALWAYS UNPLUG THE MAINS LEAD FROM THE WALL SOCKET BEFORE DISCONNECTING IT FROM THE SPEAKER.

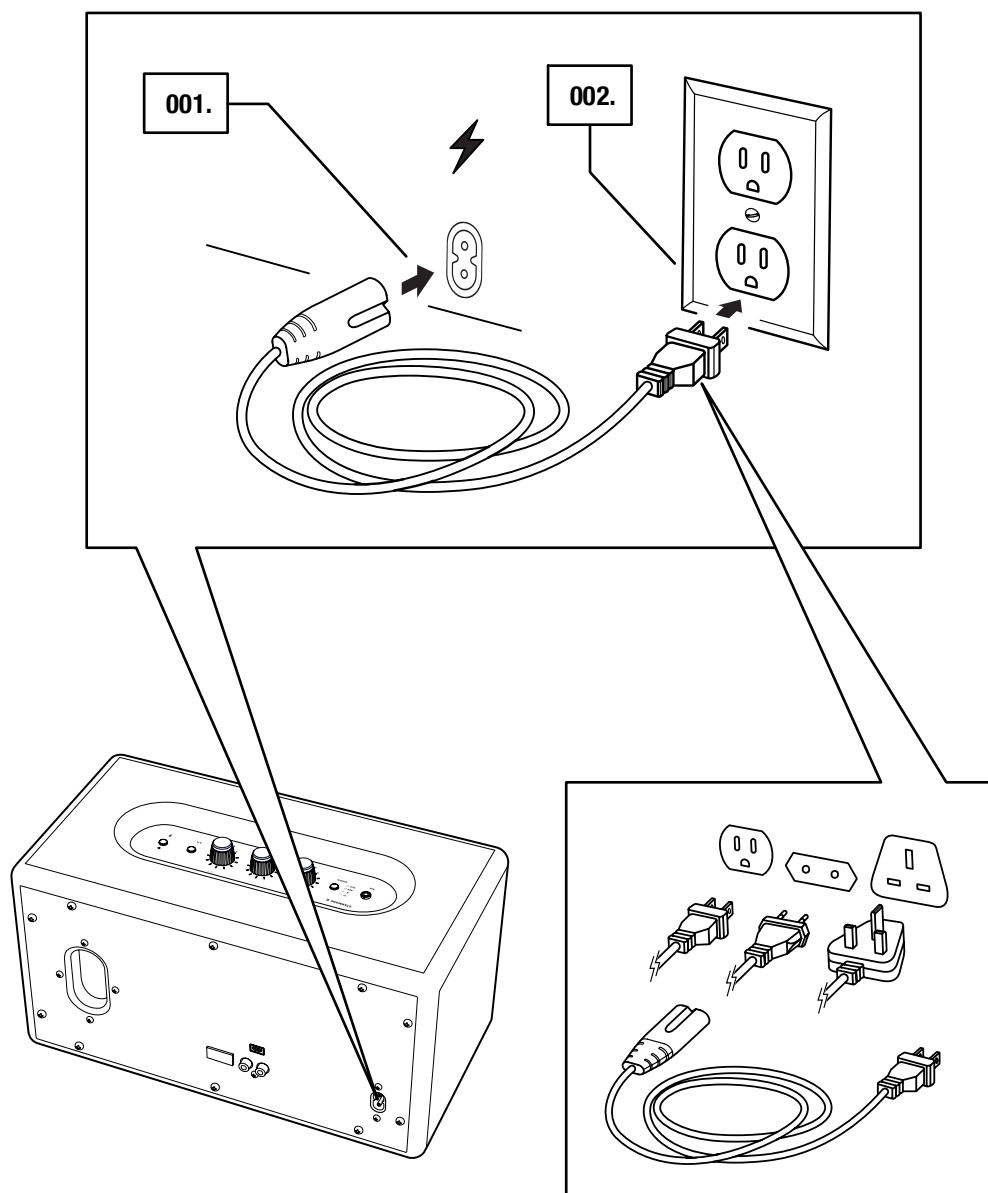

SETTING UP THE STANMORE II VOICE

CONFIGURE THE SPEAKER FOR Wi-Fi® WITH THE **MARSHALL VOICE** APP. THE APP IS AVAILABLE FROM THE APP STORE AND GOOGLE PLAY.

001. DOWNLOAD THE **MARSHALL VOICE** APP AND FOLLOW THE IN-APP INSTRUCTIONS TO SET UP YOUR SPEAKER.

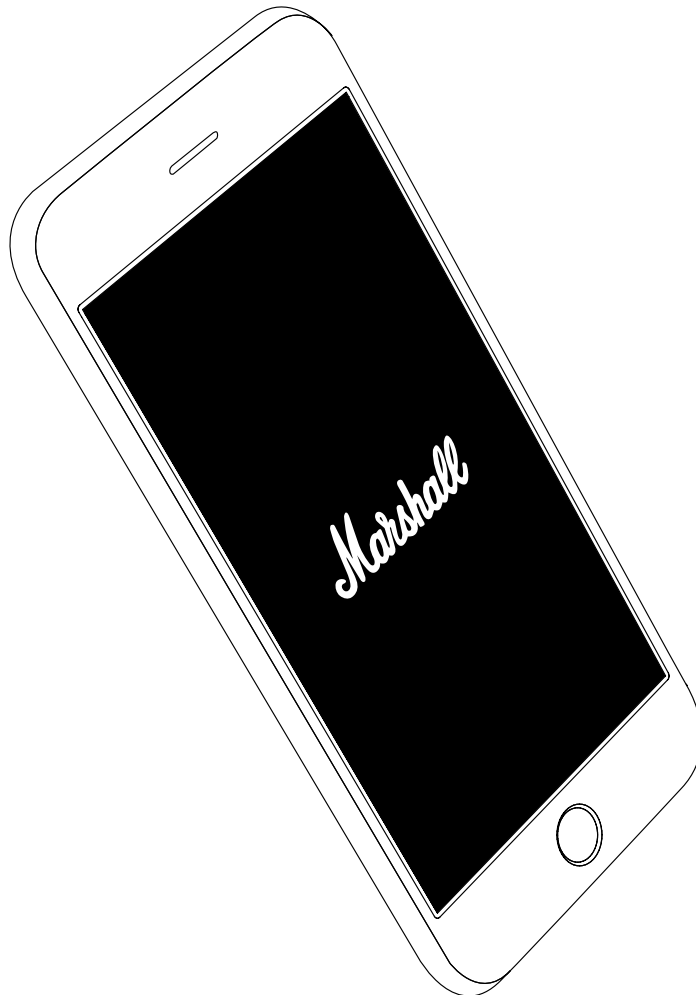

008.

Marshall

USING AMAZON ALEXA

YOU CAN TALK TO AMAZON ALEXA ON YOUR STANMORE II VOICE. WITH ALEXA, YOU CAN ASK TO PLAY MUSIC, HEAR THE NEWS, CHECK WEATHER, CONTROL SMART HOME DEVICES, AND MORE. SIGN IN TO AMAZON ALEXA FROM THE MARSHALL VOICE APP TO ENABLE ALEXA ON YOUR STANMORE II VOICE.

ACTIVATE ALEXA BY SAYING **ALEXA** OR PUSHING THE MICROPHONE BUTTON.

- ALEXA, WHAT'S THE WEATHER?
- ALEXA, TURN UP THE VOLUME.
- ALEXA, REWIND 15 SECONDS.

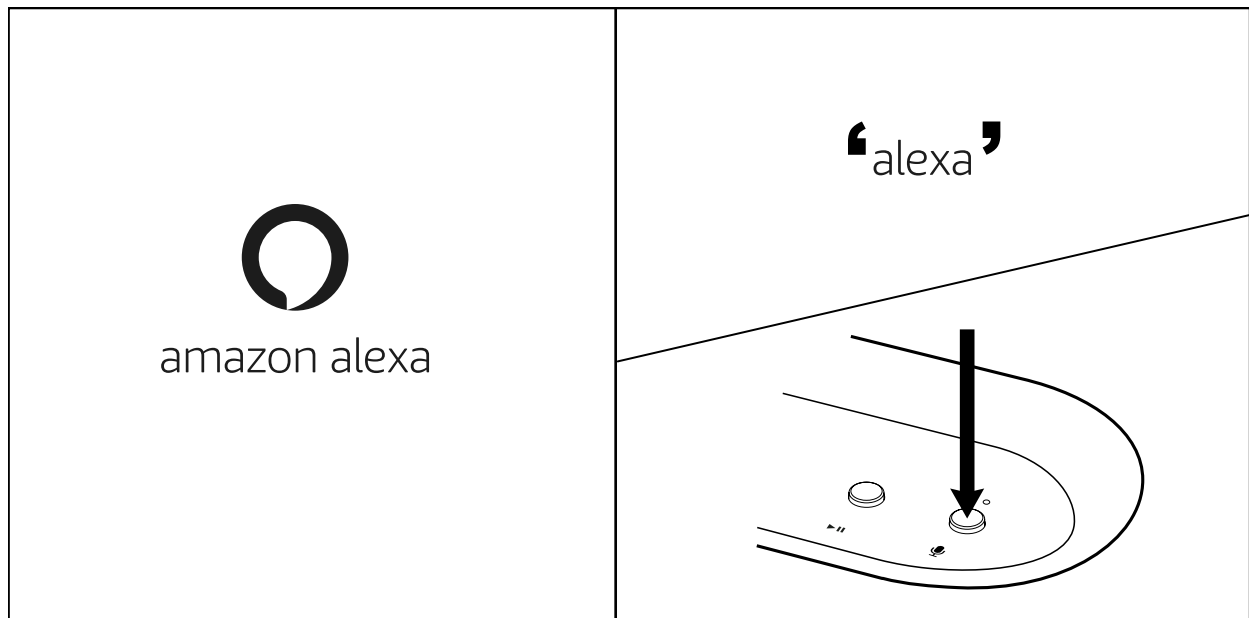

NOTE: DOWNLOAD THE AMAZON ALEXA APP FOR MORE ALEXA SETTINGS AND ENHANCED FEATURES.

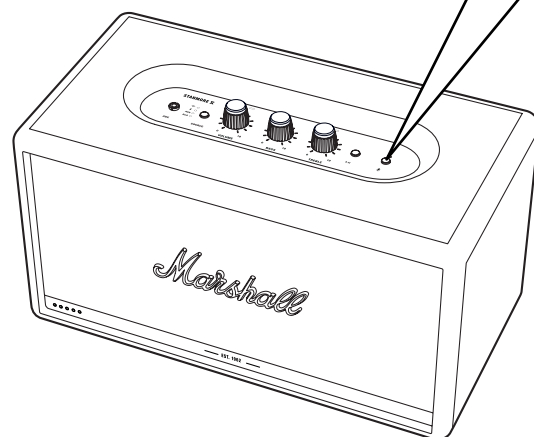

SELECTING AUDIO SOURCE

THERE ARE MANY WAYS TO CONNECT TO YOUR STANMORE II VOICE, EITHER WIRELESSLY OR BY CABLE.

-  - Wi-Fi STREAMING, ALEXA OR SPOTIFY CONNECT®
-  - WIRELESS Bluetooth® CONNECTION
- AUX - 3.5 mm STEREO JACK
- RCA - DOUBLE RCA (LEFT AND RIGHT) JACKS

001. PUSH THE **SOURCE** BUTTON TO TOGGLE BETWEEN Wi-Fi, Bluetooth, AUX AND RCA AUDIO SOURCE.

A LIT INDICATOR SHOWS WHICH SOURCE IS SELECTED.

002. THE SOURCE CAN ALSO BE SELECTED FROM THE **MARSHALL VOICE** APP.

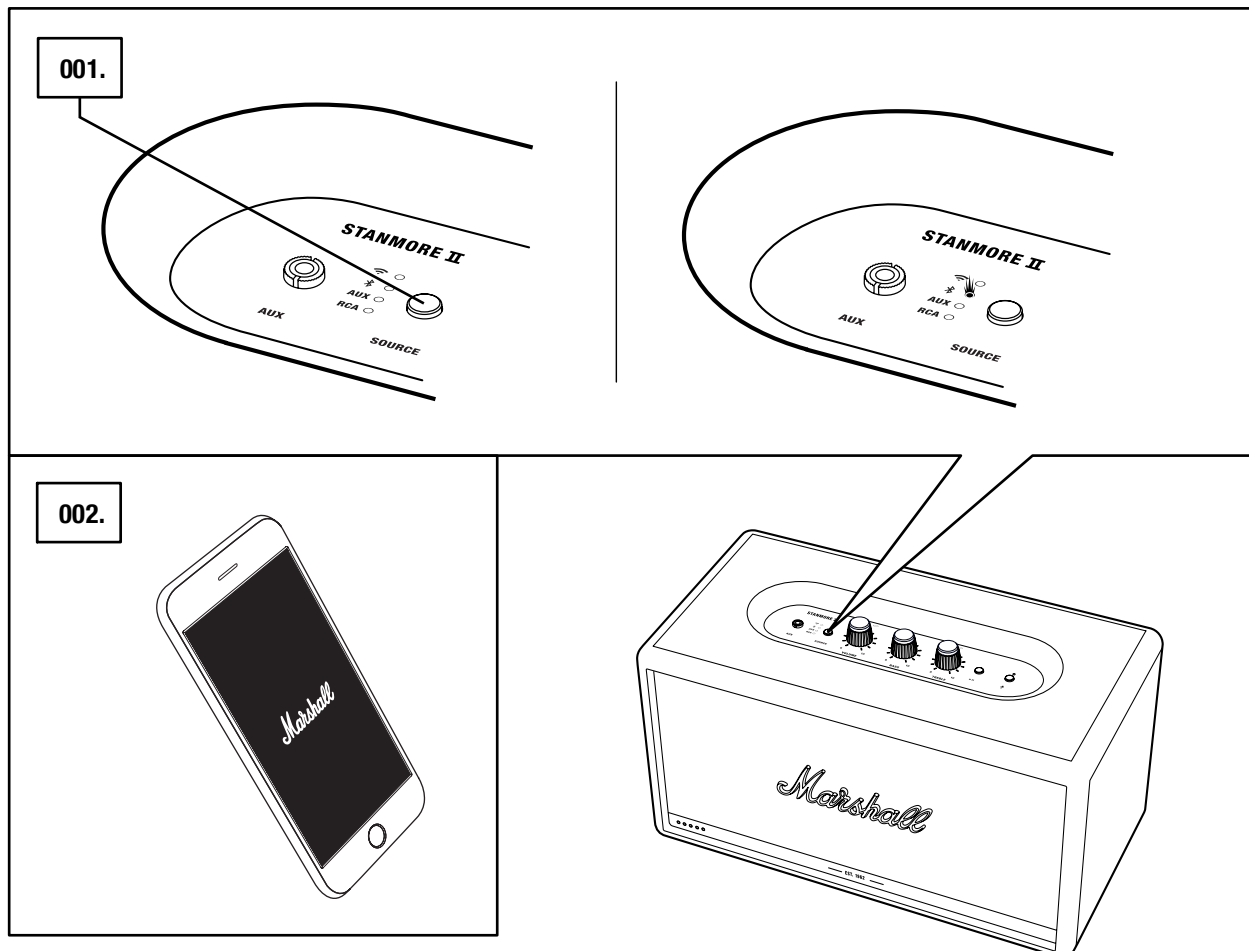

CAUTION: MAKE SURE THAT THE VOLUME IS SET TO LOW ON BOTH THE SPEAKER AND THE MUSIC PLAYER BEFORE USING THE SPEAKER.

USING STANMORE II VOICE WITH SPOTIFY CONNECT®

LISTEN OUT LOUD WITH SPOTIFY CONNECT.

- 001. CONNECT YOUR STANMORE II VOICE TO THE SAME Wi-Fi NETWORK AS YOUR PHONE, TABLET OR PC RUNNING THE SPOTIFY APP.**
- 002. OPEN UP THE SPOTIFY APP ON YOUR PHONE, TABLET OR LAPTOP USING THE SAME Wi-Fi NETWORK.**
- 003. PLAY A SONG AND SELECT DEVICES AVAILABLE.**
- 004. SELECT YOUR STANMORE II VOICE AND START LISTENING.**

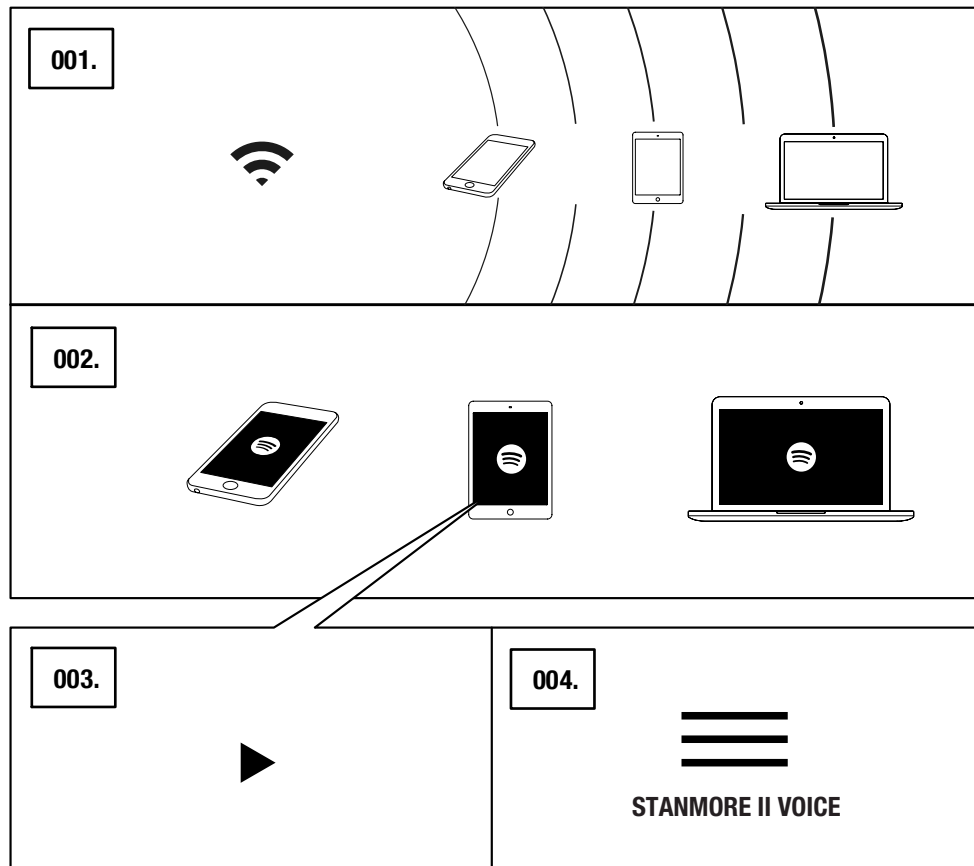
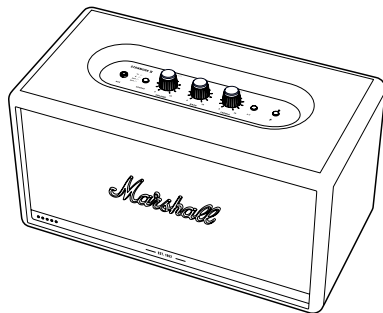

CONNECTING VIA Bluetooth® (PAIRING)

001. SELECT Bluetooth AS THE INPUT. PUSHING THE **SOURCE** BUTTON TOGGLES THE INPUT SOURCES.
002. PUSH AND HOLD THE **SOURCE** BUTTON FOR 2 SECONDS. THE Bluetooth INDICATOR STARTS TO BLINK.
003. ENABLE Bluetooth ON YOUR DEVICE (SMARTPHONE, TABLET, COMPUTER).
004. SELECT **STANMORE II VOICE** FROM THE Bluetooth LIST AND ACCEPT PAIRING. THE Bluetooth INDICATOR ON THE SPEAKER STOPS BLINKING AND REMAINS LIT WHEN THE UNITS ARE CONNECTED.

THE STANMORE II VOICE STORES UP TO EIGHT Bluetooth DEVICES AND TRIES TO CONNECT TO THE LAST CONNECTED DEVICE FIRST. FOR EXAMPLE, IF THE SPEAKER HAS BEEN CONNECTED TO THE DEVICES: **A-B-C-D-E-F-G-H** DEVICE **H** IS GIVEN FIRST PRIORITY, WHILE DEVICE **A** IS GIVEN LAST PRIORITY. EVERY TIME IS SELECTED, THE SPEAKER WILL PERFORM AN AUTO CONNECTION OF DEVICES WITHIN ITS RANGE.

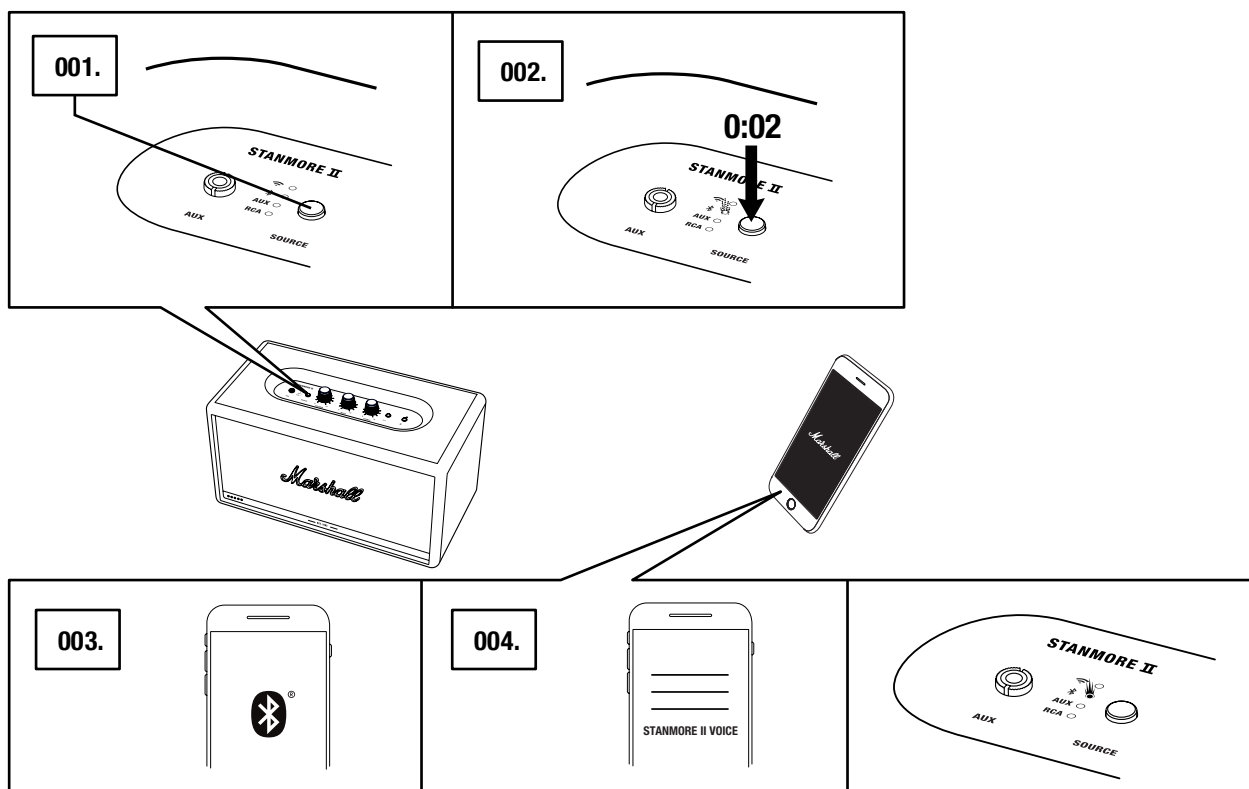

CONNECTING VIA AUX INPUT

001. CONNECT A 3.5 mm STEREO JACK TO THE INPUT LABELLED **AUX** ON THE TOP OF SPEAKER.
002. CONNECT THE OTHER END OF THE LEAD TO THE AUDIO OUTPUT ON YOUR AUDIO SOURCE.
003. SELECT AUX AS THE INPUT. PUSHING THE **SOURCE** BUTTON TOGGLES THE INPUT SOURCES.

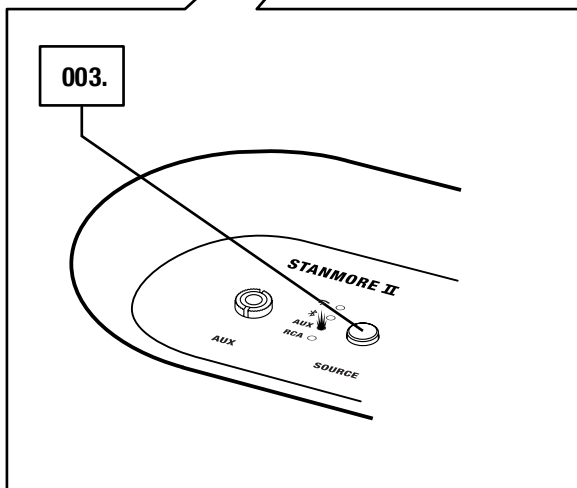
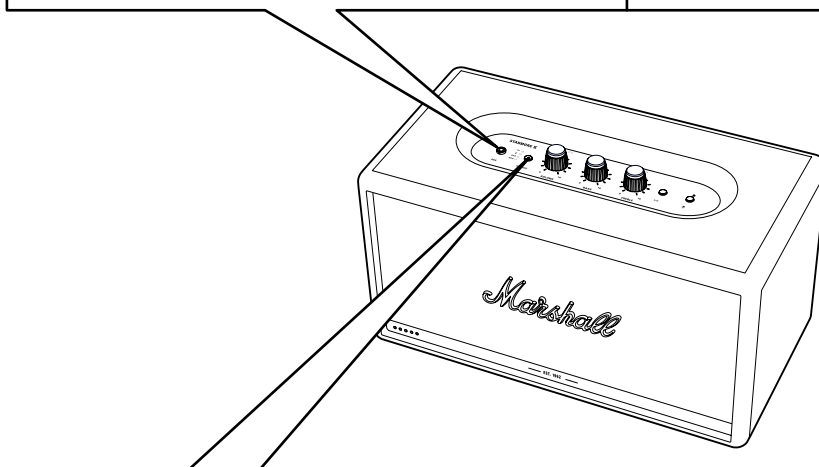
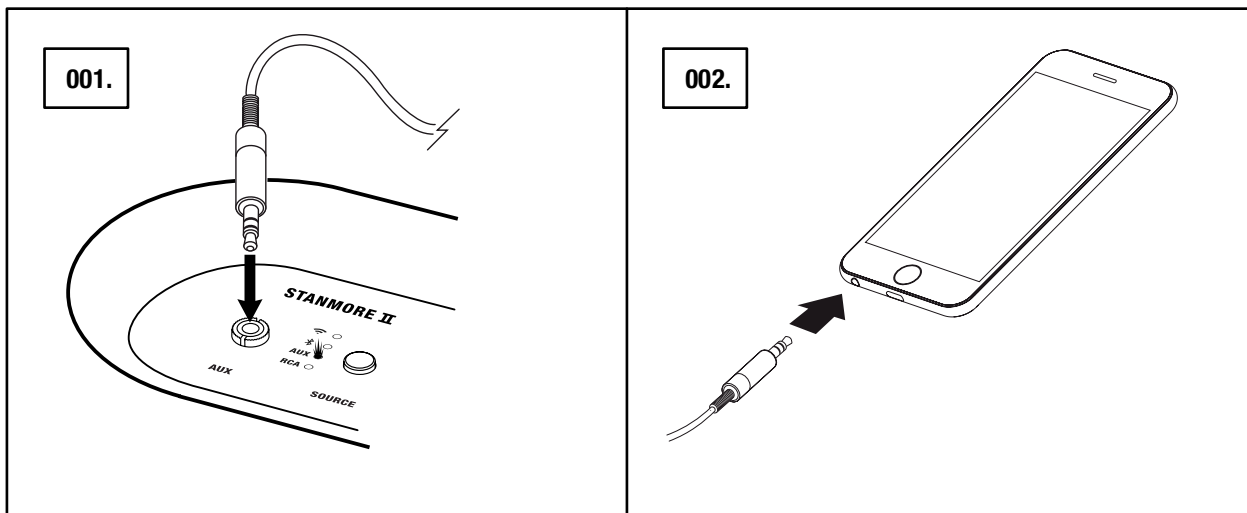

 NOTE: AUDIO LEADS ARE NOT INCLUDED IN THE STANMORE II VOICE.

CONNECTING VIA RCA INPUT

001. CONNECT A LEAD WITH RCA JACKS TO THE INPUTS LABELLED **RCA** ON THE BACK OF THE SPEAKER.
002. CONNECT THE OTHER END OF THE LEAD TO THE OUTPUT ON YOUR AUDIO SOURCE.
003. SELECT RCA AS THE INPUT. PUSHING THE **SOURCE** BUTTON TOGGLES THE INPUT SOURCES.

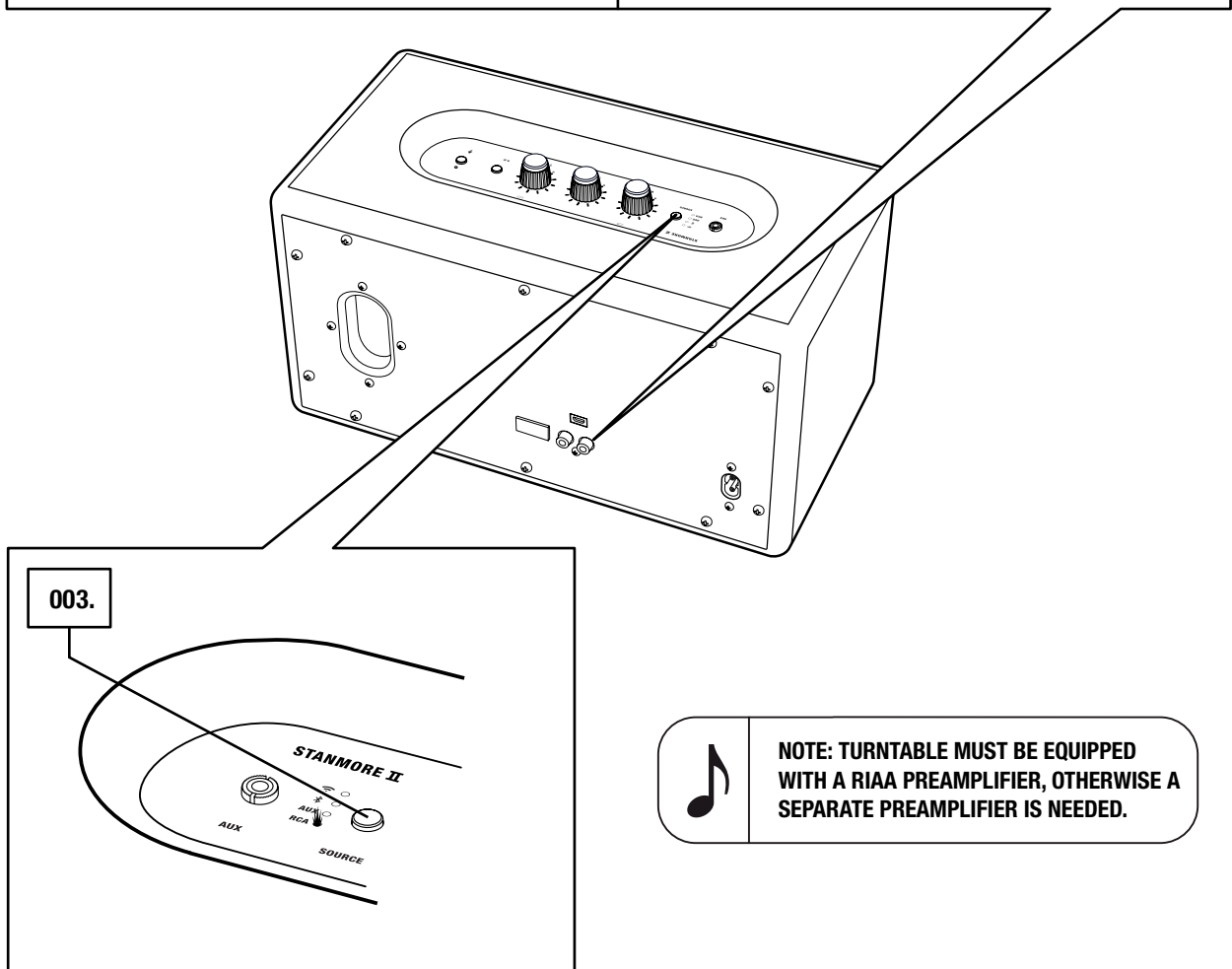
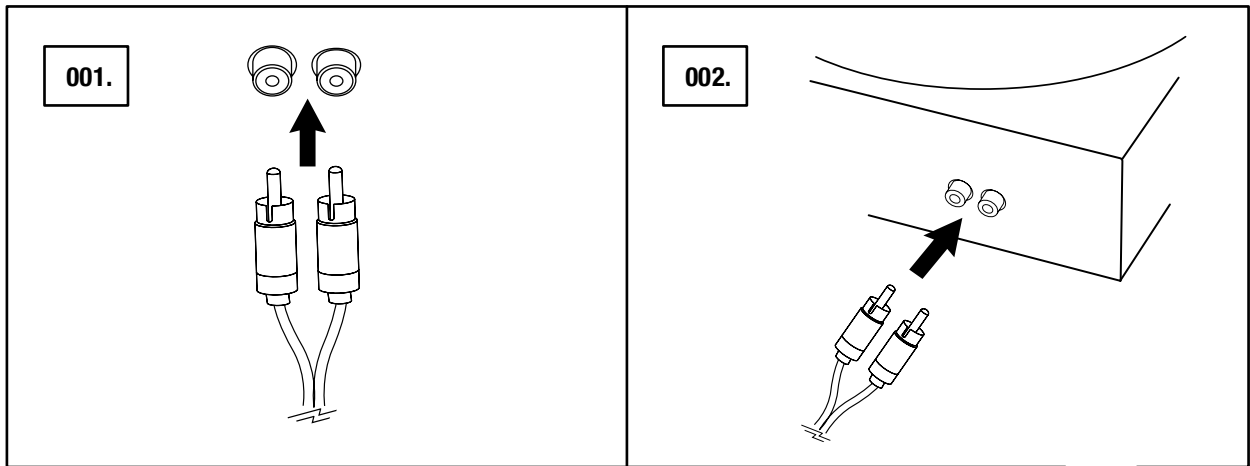

ADJUSTING THE VOLUME/BASS/TREBLE

THE STANMORE II VOICE INCLUDES THREE KNOBS FOR ADJUSTING THE AUDIO.

001. VOLUME KNOB

002. BASS KNOB

003. TREBLE KNOB

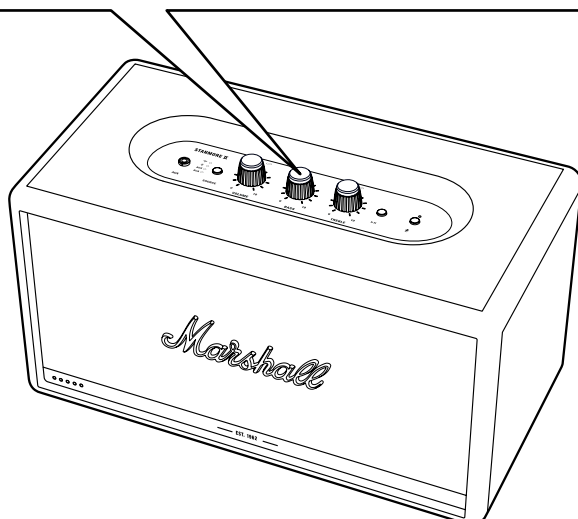
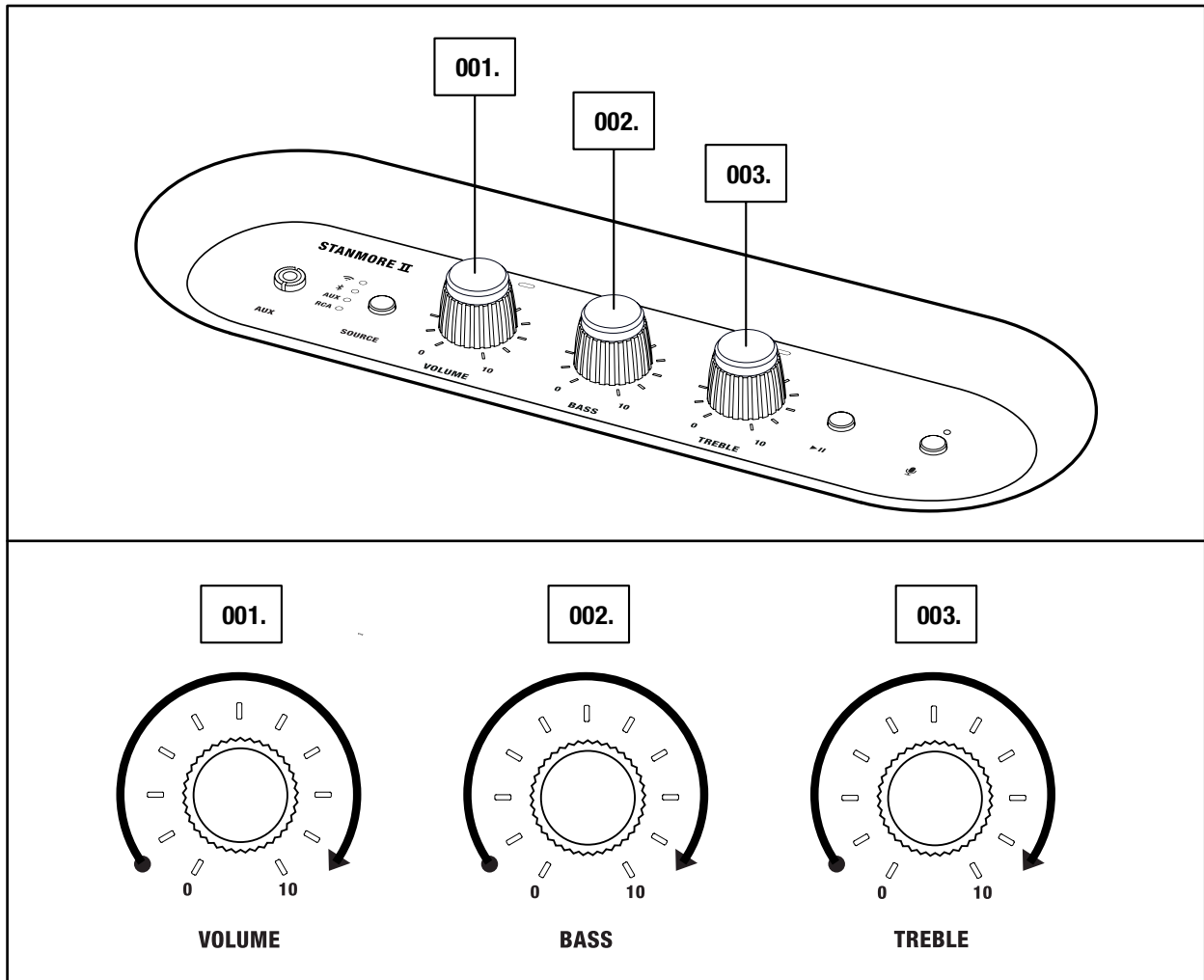



 NOTE: THE AUDIO CAN ALSO BE ADJUSTED FROM THE MARSHALL VOICE APP.

PLAY/PAUSE CONTROL

THE STANMORE II VOICE HAS A PLAY/PAUSE BUTTON TO CONTROL THE MUSIC WHEN PLAYING VIA ALEXA, SPOTIFY CONNECT OR Bluetooth.

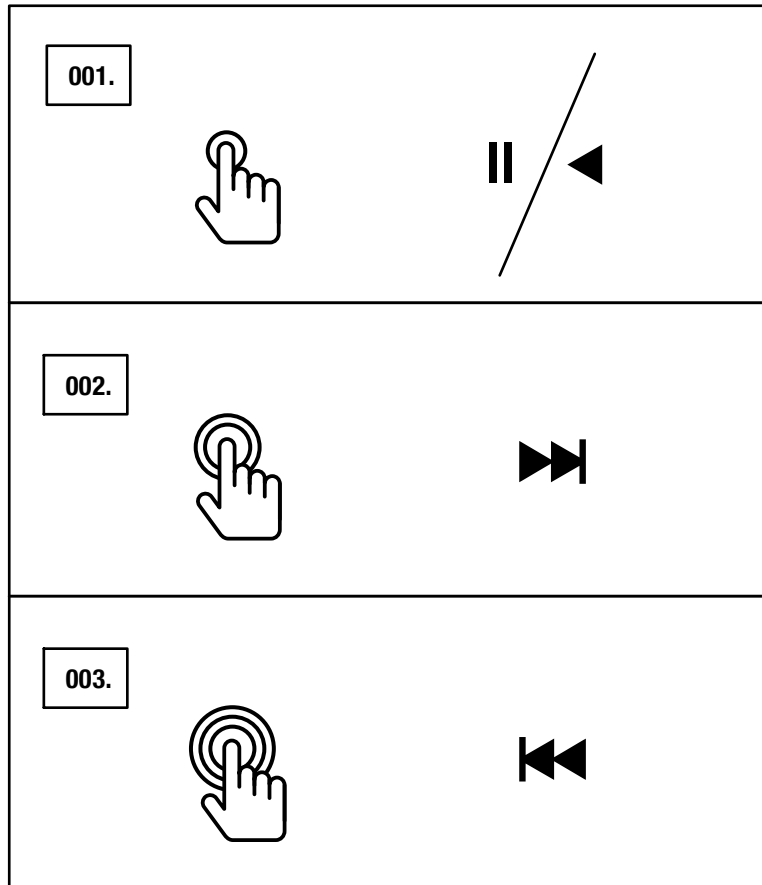
- 001. SINGLE-CLICK TO EITHER PLAY OR PAUSE.
- 002. DOUBLE-CLICK TO SKIP FORWARD.
- 003. TRIPLE-CLICK TO SKIP BACK.



 NOTE: PLAYBACK CAN ALSO BE CONTROLLED FROM THE MARSHALL VOICE APP.

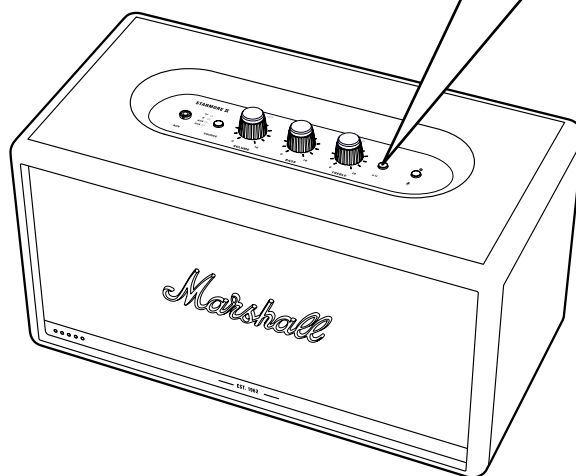

MUTING/UNMUTING THE MICROPHONE

THE MICROPHONES IN THE STANMORE II VOICE CAN BE TEMPORARILY TURNED OFF.

001. PUSH AND HOLD THE MICROPHONE BUTTON FOR 3 SECONDS TO MUTE THE MICROPHONES.

THE LED INDICATORS ON THE FRONT TURNS RED TO INDICATE THAT THE MICROPHONE IS MUTED.

002. TO UNMUTE, PUSH AND HOLD THE MICROPHONE BUTTON FOR 3 SECONDS.

THE LED INDICATORS ON THE FRONT TURNS OFF TO INDICATE THAT THE MICROPHONE IS UNMUTED.

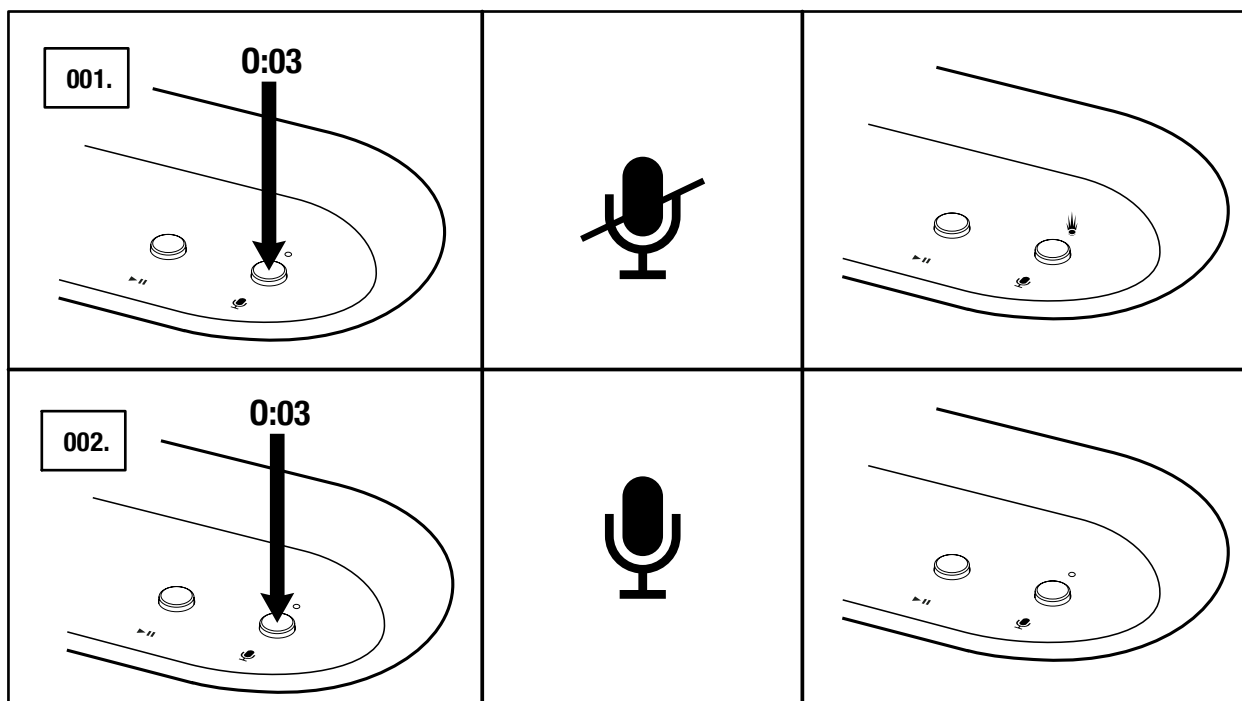

 **NOTE: ALEXA CAN NOT BE ACTIVATED WHILE THE MICROPHONES ARE MUTED.**

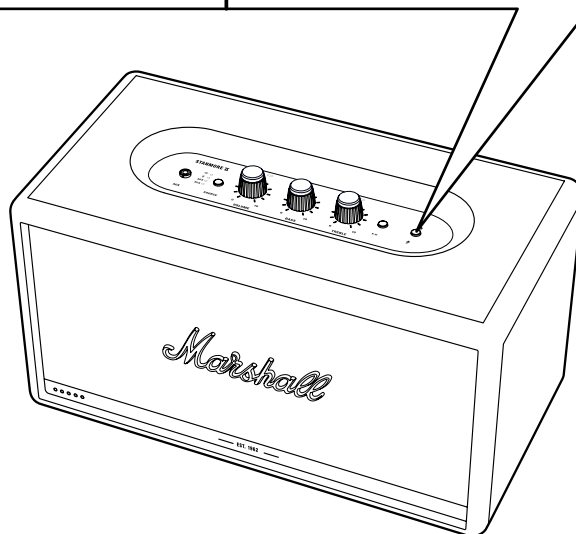

TECHNICAL INFORMATION

ACOUSTIC SPECIFICATION

- **STEREO LOUDSPEAKER WITH BASS REFLEX SYSTEM**
- **DIGITAL CLASS D AMPLIFIERS:** 2 x 15 W + 1 x 50 W
- **¾" DOME TWEETERS:** 2x
- **5¼" WOOFER:** 1x
- **BASS AND TREBLE TONE CONTROLS**
- **FREQUENCY RESPONSE:** 50–20,000 Hz ±6 dB
- **MAXIMUM SOUND PRESSURE LEVEL:** 101 dB SPL @ 1 m

TECHNICAL INFORMATION

- **MAINS INPUT VOLTAGE:** 100–240 VAC
- **MAINS FREQUENCY:** 50–60 Hz
- **NETWORK STANDBY POWER CONSUMPTION:** <2 W
- **WIRELESS CONNECTIVITY:**
 - Spotify Connect
 - Bluetooth
- **WIRED CONNECTIVITY:**
 - AUX: 3.5 mm stereo jack
 - RCA (left and right)
- **Wi-Fi SUPPORT:** Connects to your home Wi-Fi network with any WPA, 802.11b/g/n/ac 2.4 GHz/5 GHz with diversity.
- **SIZE:** 350 x 195 x 185 mm
- **WEIGHT:** 4.75 Kg
- **VOICE CONTROL SERVICE:** Amazon Alexa
- **MICROPHONE SYSTEM:** A dual microphone array with acoustic noise cancellation for far field voice interaction.

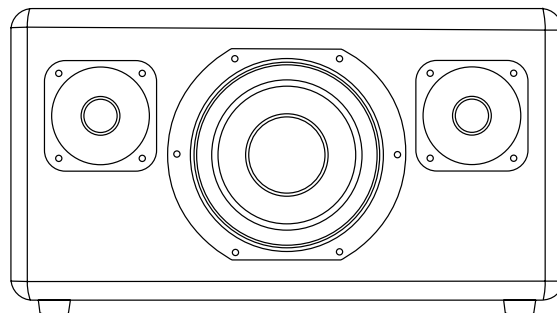

NOTE: THE FRONT OF THE SPEAKER IS NOT REMOVABLE. THIS ILLUSTRATION INTENDS TO SHOW THE INTERNAL SPEAKER LAYOUT. DO NOT ATTEMPT TO REMOVE THE FRET FOR RISK OF DAMAGING YOUR SPEAKER.

TROUBLESHOOTING

| PROBLEM | CAUSE | ACTION |
|---|--|---|
| THE STANMORE II DOES NOT TURN ON | The speaker is not connected to mains electricity supply. | Connect the mains lead to the Stanmore II and a working wall socket. Pull and hold the power lever towards the front of the speaker until the indicators light up. |
| THE STANMORE II VOICE CANNOT BE DISCOVERED BY THE MARSHALL VOICE APP | The speaker is not in setup mode. | Select Wi-Fi as the input. Push and hold the Source button for 3 seconds to set the speaker in discoverable mode. |
| | The speaker and the mobile device are not connected to the same Wi-Fi network. | Ensure that your mobile device is connected to the same Wi-Fi network that the speaker was configured on. |
| ALEXA IS NOT RESPONDING | The microphone is muted on the speaker. | Push and hold the microphone button for 3 seconds. The LED indicators on the front turns off to indicate that the microphone is unmuted. |
| THERE IS NO AUDIO OR AUDIO IS TOO LOW | The wrong sound source is selected. | Ensure that the device is connected to the Stanmore II. Check that there is no other device connected that is playing. |
| | Volume is set too low on either the audio source or the speaker. | Slightly increase the volume on your audio source or the speaker. |

TROUBLESHOOTING

| PROBLEM | CAUSE | ACTION |
|---|---|--|
| CANNOT CONNECT OR PAIR WITH A BLUETOOTH DEVICE | Bluetooth is not enabled on your device (smartphone, tablet, computer). | Activate Bluetooth on your device. |
| | There are already two devices connected to the speaker. | Disconnect one of the connected Bluetooth devices before connecting to the speaker. |
| | The speaker is not in pairing mode. | Push and hold the Bluetooth button for 3 seconds to make the speaker discoverable by the device. |
| THE SPEAKER IS NOT RESPONDING | A software problem has occurred. | Unplug the mains power plug from the wall socket, wait for 15 seconds, then plug it in again. |
| | | Perform a factory reset. Note: This will delete all user settings and after the factory reset, the speaker needs to be set up again. Push and hold both the Source button and the Play/pause button for 7 seconds. |
| BLUETOOTH CONNECTION DROPS OUT | The two Bluetooth devices are too far apart or the connection is affected due to obstacles. | Move the devices closer so that they are within 10 metres, and unobstructed by obstacles such as walls or doors. |
| | There is a strong electric field surrounding the Stanmore II. | Items such as microwave ovens, wireless network adapters, fluorescent lights and gas cookers use the same frequency range as the Bluetooth device. This may lead to electrical disturbances. |

TROUBLESHOOTING

| PROBLEM | CAUSE | ACTION |
|-----------------------------------|--|---|
| THERE IS A CRACKLING SOUND | The amplifier is clipping as it has run out of output power. | Decrease the volume on your audio source. |
| | | Lower the volume or bass on the Stanmore II. |
| THE AUDIO IS DISTORTED | Volume is set too high on the audio source. | Turn down the playback volume on the audio source. |
| | The audio stream or audio file is of poor quality. | Try another audio file or music player. |
| | Volume is set too high on the Stanmore II. | Lower the volume on the speaker. |
| | Too much bass/treble on the speaker. | Lower the bass/treble on the speaker. |
| ERRATIC PERFORMANCE | Interference from another electronic device. | Move the Stanmore II to another spot. |
| | | Turn off or move the interfering electronic device. |

WWW.MARSHALLHEADPHONES.COM