

Walkstick / Wallstick

Designed by Antonio Citterio





Walkstick 2 Double



Walkstick Pipe

Famiglia / Family

Walkstick



Power Led

2,5W
185 lm - 2700K/CRI 80
199 lm - 3000K/CRI 80
212 lm - 4000K/CRI 80

2200K available on request.

Walkstick Pipe



Power Led

7W
483 lm - 2700K/CRI 80
496 lm - 3000K/CRI 80
529 lm - 4000K/CRI 80

2200K available on request.

Walkstick



Power Led

6W
333 lm - 2700K/CRI 80
358 lm - 3000K/CRI 80
382 lm - 4000K/CRI 80

2200K available on request.

Walkstick Double



Power Led

8,5W
333+185 lm - 2700K/CRI 80
358+199 lm - 3000K/CRI 80
382+212 lm - 4000K/CRI 80

2200K available on request.

Colori / Colours



01 White



06 Grey



12 Forest Green



18 Deep Brown



30 Black



33 Anthracite

Walkstick

Descrizione

Walkstick Pipe

Collezione di paletti per esterno con sorgente luminosa a LED e testa tubolare orientabile 350° sull'asse verticale e 350° sull'asse orizzontale. Disponibili in due differenti altezze. Lo stelo e la testa sono realizzati in alluminio estruso, la base in alluminio pressofuso a basso contenuto di rame. Disponibile in differenti finiture con un rivestimento a doppio strato con polveri secondo lo standard QUALICOAT. Il primo strato di polvere epossidica dà resistenza chimica e meccanica, il secondo strato di finitura di polvere poliestere assicura resistenza ai raggi UV ed agli agenti atmosferici corrosivi. Le superfici verniciate sono trattate con lavaggi alcalini e acidi, risciacquate con acqua demineralizzata e sottoposte a un trattamento di conversione chimica per proteggere contro l'ossidazione.

Le viterie di fissaggio sono in acciaio inox AISI 316L.

Diffusore in vetro acidato per garantire una diffusione uniforme della luce a terra.

L'apparecchio è fornito con uno spezzone di cavo uscente in neoprene.

Può essere installato facilmente a terra su qualsiasi pavimento con tasselli, oppure utilizzando l'accessorio dedicato cassaforma per rendere la base del prodotto totalmente solidale con la pavimentazione.

Walkstick

Collezione di paletti per esterno con sorgente luminosa a LED e testa svasata orientabile 350° sull'asse verticale. Disponibili in due differenti altezze combinate alla versione con una luce o due luci.

Lo stelo è realizzato in alluminio estruso, la base e la testa in alluminio pressofuso EN AB-47100 a basso contenuto di rame.

Disponibile in differenti finiture con un rivestimento a doppio strato con polveri secondo lo standard QUALICOAT. Il primo strato di polvere epossidica dà resistenza chimica e meccanica, il secondo strato di finitura di polvere poliestere assicura resistenza ai raggi UV ed agli agenti atmosferici corrosivi. Le superfici verniciate sono trattate con lavaggi alcalini e acidi, risciacquate con acqua demineralizzata e sottoposte a un trattamento di conversione chimica per proteggere contro l'ossidazione.

Le viterie di fissaggio sono in acciaio inox AISI 316L.

Diffusore in vetro microtexturizzato per garantire una distribuzione omogenea della luce a terra.

Può essere installato facilmente a terra su qualsiasi pavimento con tasselli, oppure utilizzando l'accessorio dedicato cassaforma per rendere la base del prodotto totalmente solidale con la pavimentazione.

Wallstick

Apparecchio segnapasso a parete per esterno con sorgente luminosa a LED e testa svasata orientabile 350° sull'asse verticale. Il corpo apparecchio è realizzato in alluminio pressofuso a basso contenuto di rame.

Disponibile in differenti finiture con un rivestimento a doppio strato con polveri secondo lo standard QUALICOAT. Il primo strato di polvere epossidica dà resistenza chimica e meccanica, il secondo strato di finitura di polvere poliestere assicura resistenza ai raggi UV ed agli agenti atmosferici corrosivi. Le superfici verniciate sono trattate con lavaggi alcalini e acidi, risciacquate con acqua demineralizzata e sottoposte a un trattamento di conversione chimica per proteggere contro l'ossidazione.

Le viterie di fissaggio sono in acciaio inox AISI 316L.

Diffusore in vetro microtexturizzato per garantire una distribuzione omogenea della luce a terra.

L'apparecchio è fornito con due cavi di alimentazione uscenti L 200mm e con un kit per la connessione a tenuta IP.

L'alimentatore elettrico a 24V può essere installato in remoto. Per una installazione più agevole è disponibile la cassaforma opzionale (scatola di derivazione 3 moduli modello 503)

Description

Walkstick Pipe

Collection of outdoor poles with LED light source and tubular head that can be adjusted 350° on the vertical and horizontal axes. Available in two different heights.

The stem and head are made of extruded aluminium; the base is made of die-cast aluminium with low copper content.

Available in different finishes with a double layer of powder coating according to the QUALICOAT standard. The first layer of epoxy powder confers chemical and mechanical resistance. The second layer, a polyester powder finish, ensures resistance to UV rays and corrosive atmospheric agents. The painted surfaces are treated with alkiline and acid washes, rinsed with demineralized water, and subjected to chemical conversion treatment to protect against rust.

The anchoring hardware is made of AISI 316L stainless steel.

Diffuser made of acid-etched glass to guarantee a uniform wash of light on the ground.

The unit is supplied with a length of neoprene cable.

The unit may be easily installed on any flooring on the ground with anchors, or with the dedicated installation box to completely integrate the base of the product with the pavement.

Walkstick

Collection of outdoor poles with LED light source and tubular head that can be adjusted vertically 350°. Available in two different heights combined with the one- or two-light version.

The stem is made of extruded aluminium; the base and head are made of EN AB-47100 die-cast aluminium with low copper content.

Available in different finishes with a double layer of powder coating according to the QUALICOAT standard. The first layer of epoxy powder confers chemical and mechanical resistance. The second layer, a polyester powder finish, ensures resistance to UV rays and corrosive atmospheric agents. The painted surfaces are treated with alkiline and acid washes, rinsed with demineralized water, and subjected to chemical conversion treatment to protect against rust.

The anchoring hardware is made of AISI 316L stainless steel.

Diffuser in micro-textured glass to guarantee uniform light distribution on the ground.

The unit may be easily installed on any flooring on the ground with anchors, or with the dedicated installation box to completely integrate the base of the product with the pavement.

Wallstick

Wall-mounted outdoor footpath lights with LED light source and flared head that can be adjusted vertically 350°. The body is made of die-cast aluminium with low copper content.

Available in different finishes with a double layer of powder coating according to the QUALICOAT standard. The first layer of epoxy powder confers chemical and mechanical resistance. The second layer, a polyester powder finish, ensures resistance to UV rays and corrosive atmospheric agents. The painted surfaces are treated with alkiline and acid washes, rinsed with demineralized water, and subjected to chemical conversion treatment to protect against rust.

The anchoring hardware is made of AISI 316L stainless steel. Diffuser in micro-textured glass to guarantee uniform light distribution on the ground.

The light comes with two 2-m power cables and with a kit for IP-rated connection.

The 24V electrical power supply can be installed remotely. For easier installation, an optional box (sold separately) is available (3-module junction box, model 503).

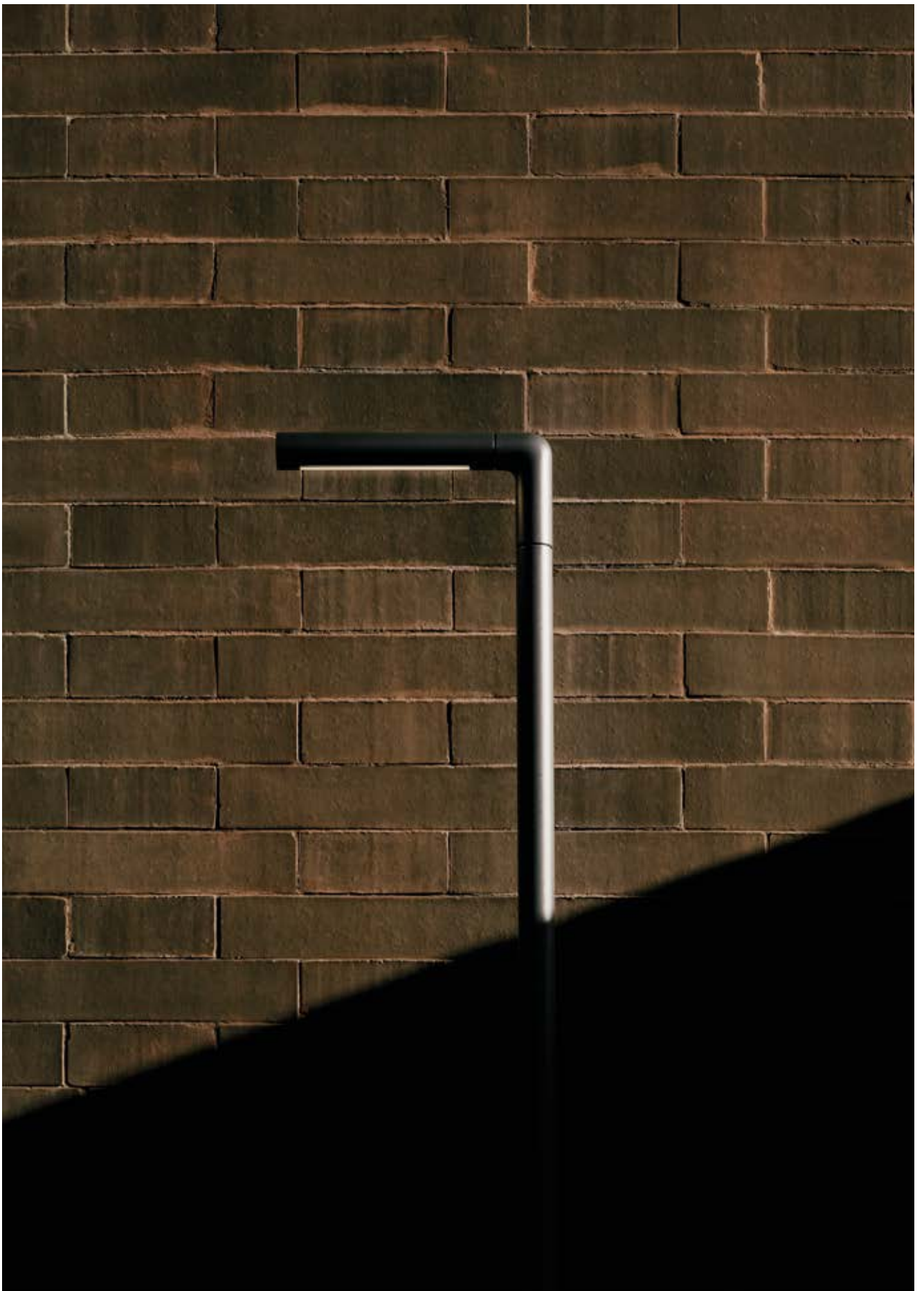

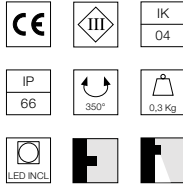
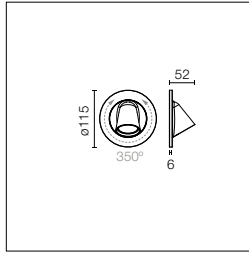

Sorgente luminosa a LED inclusa. Testa orientabile 350° sull'asse verticale. Alimentazione elettrica remota a 24V da ordinare separatamente. Apparecchio fornito con due cavi di alimentazione uscenti L 200mm e con un kit per la connessione a tenuta IP. L'alimentatore può essere installato remoto (cassaforma non necessaria) o alloggiato posteriormente all'apparecchio mediante apposita cassaforma opzionale.

LED light source included. Head adjustable 350° on the vertical axis. Remote 24V electrical power unit sold separately. Unit comes with two 200-mm-long outgoing power cables and a kit for IP-rated connection. The power supply may be installed remotely (installation box not necessary) or housed behind the unit with the optional installation box.

2200K disponibile su richiesta.

2200K available on request.

Power Led: 2,5W - 264 lm ≠ FIXT 185 lm - 2700K/CRI 80 - 24V / 2,5W - 283 lm ≠ FIXT 199 lm - 3000K/CRI 80 - 24V / 2,5W - 303 lm ≠ FIXT 212 lm - 4000K/CRI 80 - 24V

2700K

PWM Dimmable

- F010A20H001
- F010A20H006
- F010A20H012
- F010A20H018
- F010A20H030
- F010A20H033

3000K

PWM Dimmable

- F010A30H001
- F010A30H006
- F010A30H012
- F010A30H018
- F010A30H030
- F010A30H033

4000K

PWM Dimmable

- F010A40H001
- F010A40H006
- F010A40H012
- F010A40H018
- F010A40H030
- F010A40H033

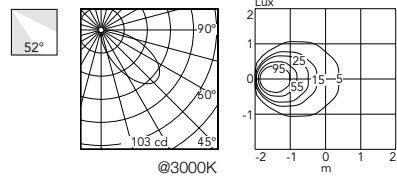

* Numero massimo di apparecchi per alimentatore / Maximum number of luminaires per power supply.

Numero massimo di apparecchi per alimentatore (Vin220÷240). Dati indicativi da verificare con le specifiche condizioni di installazione.

Maximum number of luminaires per power supply. (220÷240 V). These data must be checked taking into account the specific installation conditions.

Non Dimmable

| | |
|------------------|----|
| Acc. RF25754 | 1 |
| Acc. RF25748 | 1 |
| Acc. RF25747 | 2 |
| Acc. RF25757 | 2 |
| Acc. F990B23AZ00 | 7 |
| Acc. RF25755 | 9 |
| Acc. RF25749 | 13 |

Dimmable

| | |
|------------------|----|
| Acc. F990B02A000 | 7 |
| Acc. F990B03A000 | 7 |
| Acc. F990B16A000 | 7 |
| Acc. F990B04A000 | 13 |
| Acc. F990B05A000 | 13 |
| Acc. F990B17A000 | 13 |

Fissaggio a Parete / Installation on Wall

Option 1

Senza cassaforma / Without recessed box installation.

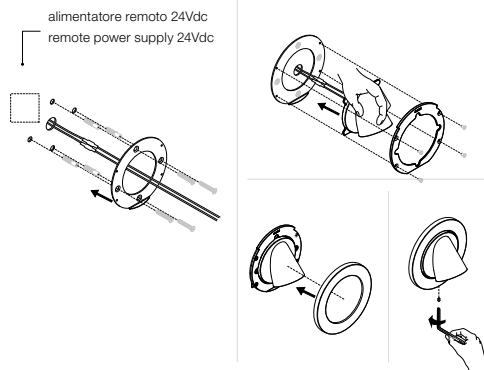

Option 2

Con cassaforma / Recessed box installation.

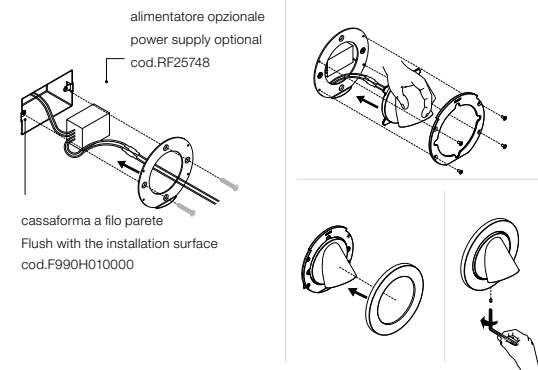

Wallstick: Accessori / Accessories

Scatola di derivazione da incasso 3 moduli (modello 503) 106x75mm H 55mm.

Recessed 3-module junction box (model 503) 106 mm x 75 mm H 55 mm.

F990H010000

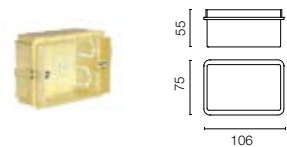

Sistema di giunzione IP68 a 2 vie 2 poli. (Ø4÷6,9mm cavo).

2 way terminal block 2 poles IP68. (Ø4÷6,9mm cable).

F990C050000



Non può essere alloggiato nella scatola per incasso.

It can't be placed in the recessed box for installation.

Wallstick: Power Supply Dimmable

| | | | | |
|---|---|--|---|---|
| Alimentatore 24V PWM con interfaccia di controllo 1-10V IP67 Classe II. Vin 120-270 Vac. | Power supply 24V PWM with 1-10V control interface IP67 Class II. Vin 120-270 Vac. | 35W *F990B02A000 70W *F990B04A000 |  |  |
| Alimentatore 24V PWM con interfaccia di controllo 1-10V IP67 Classe II. Vin 120-270 Vac. | Power supply 24V PWM with 1-10V control interface IP67 Class II. Vin 120-270 Vac. | 35W *F990B03A000 70W *F990B05A000 |  |  |
| Alimentatore 24V PWM con interfaccia di controllo PUSH IP67 Classe II. Vin 120-270 Vac. | Power supply 24V PWM with PUSH control interface IP67 Class II. Vin 120-270 Vac. | 35W *F990B16A000 70W *F990B17A000 |  |  |
| Interfaccia di controllo 24V PWM - 1-10V IP67 Class III. Vin 24Vdc 120W (Fonte di alimentazione non inclusa). | Control interface 24V PWM - 1-10V IP67 Class III. Vin 24Vdc 120W (Power supply not included). | F990B00A000 |  |  |
| Interfaccia di controllo 24V PWM - Dali IP67 Class III. Vin 24Vdc 120W (Fonte di alimentazione non inclusa). | Control interface 24V PWM - Dali IP67 Class III. Vin 24Vdc 120W (Power supply not included). | F990B01A000 |  |  |
| Interfaccia di controllo 24V PWM - Push IP67 Class III. Vin 24Vdc 120W (Fonte di alimentazione non inclusa). | Control interface 24V PWM - Push IP67 Class III. Vin 24Vdc 120W (Power supply not included). | F990B18A000 |  |  |

Wallstick: Power Supply Non Dimmable

| | | | | |
|--|---|--------------|---|---|
| Alimentatore 24V 8W / 110-240V IP20 Classe II selv. | Power supply 24V 8W / 110-240V IP20 Class II selv. | *RF25754 |  |  |
| Alimentatore 24V 8W / 110-240V IP65 Classe II selv. | Power supply 24V 8W / 110-240V IP65 Class II selv. | *RF25748 |  |  |
| Alimentatore 24V 10W / 110-240V IP20 Classe II selv. | Power supply 24V 10W / 110-240V IP20 Class II selv. | *RF25747 |  |  |
| Alimentatore 24V 10W / 110-240V IP67 Classe II selv. | Power supply 24V 10W / 110-240V IP67 Class II selv. | *RF25757 |  |  |
| Alimentatore 24Vdc 35W / 120-270V IP67 Classe II selv. | Power supply 24Vdc 35W / 120-270V IP67 Class II selv. | *F990B23AZ00 |  |  |
| Alimentatore 24Vdc 50W / 120-240V IP67 Classe II selv. | Power supply 24Vdc 50W / 120-240V IP67 Class II selv. | *RF25755 |  |  |
| Alimentatore 24Vdc 70W / 220-240V IP67 Classe II selv. | Power supply 24Vdc 70W / 220-240V IP67 Class II selv. | *RF25749 |  |  |

Walkstick Pipe 1

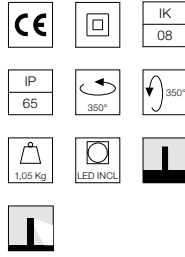
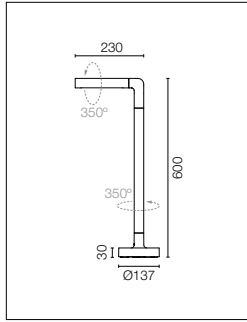

Alimentazione elettrica 220-240V inclusa. Pronto per l'installazione su superficie solida.
 Box per l'installazione a terra da ordinare separatamente.
 Include un sistema di giunzione IP68 H₂O Stop anti-condensa a 2 vie 4 poli.
 Versione 110V a richiesta.

220-240V power supply included. Ready for installation on solid surface. Box for ground installation to be ordered separately.
 Included 2 way terminal block 4 poles IP68 H₂O Stop.
 Version 110V upon request.

2200K disponibile su richiesta.

2200K available on request.

Power Led: 7W - 622 lm ≠ FIXT 483 lm - 2700K/CRI 80 - 220-240V / 7W - 648 lm ≠ FIXT 496 lm - 3000K/CRI 80 - 220-240V / 7W - 693 lm ≠ FIXT 529 lm - 4000K/CRI 80 - 220-240V

2700K

Non Dimmable

- F010H21A001
- F010H21A006
- F010H21A012
- F010H21A018
- F010H21A030
- F010H21A033
- 1-10V
- F010H21B001
- F010H21B006
- F010H21B012
- F010H21B018
- F010H21B030
- F010H21B033

3000K

Non Dimmable

- F010H31A001
- F010H31A006
- F010H31A012
- F010H31A018
- F010H31A030
- F010H31A033
- 1-10V
- F010H31B001
- F010H31B006
- F010H31B012
- F010H31B018
- F010H31B030
- F010H31B033

4000K

Non Dimmable

- F010H41A001
- F010H41A006
- F010H41A012
- F010H41A018
- F010H41A030
- F010H41A033
- 1-10V
- F010H41B001
- F010H41B006
- F010H41B012
- F010H41B018
- F010H41B030
- F010H41B033

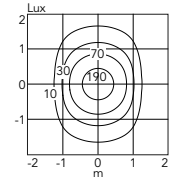
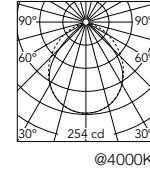

Walkstick Pipe 2

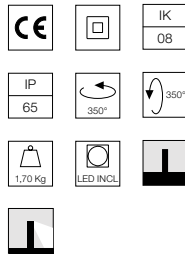
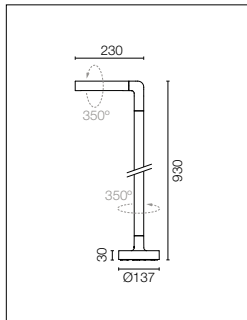

Alimentazione elettrica 220-240V inclusa. Pronto per l'installazione su superficie solida.
 Box per l'installazione a terra da ordinare separatamente.
 Include un sistema di giunzione IP68 H₂O Stop anti-condensa a 2 vie 4 poli.
 Versione 110V a richiesta.

220-240V power supply included. Ready for installation on solid surface. Box for ground installation to be ordered separately.
 Included 2 way terminal block 4 poles IP68 H₂O Stop.
 Version 110V upon request.

2200K disponibile su richiesta.

2200K available on request.

Power Led: 7W - 622 lm ≠ FIXT 483 lm - 2700K/CRI 80 - 220-240V / 7W - 648 lm ≠ FIXT 496 lm - 3000K/CRI 80 - 220-240V / 7W - 693 lm ≠ FIXT 529 lm - 4000K/CRI 80 - 220-240V

2700K

Non Dimmable

- F010J21A001
- F010J21A006
- F010J21A012
- F010J21A018
- F010J21A030
- F010J21A033
- 1-10V
- F010J21B001
- F010J21B006
- F010J21B012
- F010J21B018
- F010J21B030
- F010J21B033
- Dali
- F010J21D001
- F010J21D006
- F010J21D012
- F010J21D018
- F010J21D030
- F010J21D033

3000K

Non Dimmable

- F010J31A001
- F010J31A006
- F010J31A012
- F010J31A018
- F010J31A030
- F010J31A033
- 1-10V
- F010J31B001
- F010J31B006
- F010J31B012
- F010J31B018
- F010J31B030
- F010J31B033
- Dali
- F010J31D001
- F010J31D006
- F010J31D012
- F010J31D018
- F010J31D030
- F010J31D033

4000K

Non Dimmable

- F010J41A001
- F010J41A006
- F010J41A012
- F010J41A018
- F010J41A030
- F010J41A033
- 1-10V
- F010J41B001
- F010J41B006
- F010J41B012
- F010J41B018
- F010J41B030
- F010J41B033
- Dali
- F010J41D001
- F010J41D006
- F010J41D012
- F010J41D018
- F010J41D030
- F010J41D033

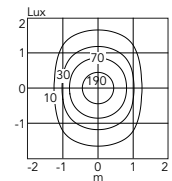
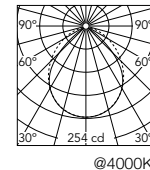

Walkstick 1

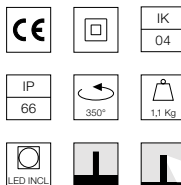
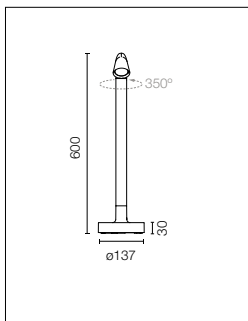

Sorgente luminosa a LED inclusa. Testa orientabile 350° sull'asse verticale e 350° sull'asse orizzontale. Alimentazione elettrica 220-240V ON/OFF integrata. Dotato di uno spezzone di cavo uscente in neoprene e un sistema di giunzione IP68 H₂O Stop anti-condensa a 2 vie. Cassafornia per l'installazione a terra opzionale da ordinare separatamente. Versione 110V a richiesta

LED light source included. Head adjustable 350° on both the vertical and horizontal axes. Integrated 220-240V ON/OFF electrical power. Equipped with a length of neoprene cable and an IP68 2-way stop anti-condensation H₂O stop seal system. Box for ground installation sold separately. 110V version by request.

2200K disponibile su richiesta.

2200K available on request.

Power Led: 6W - 502 lm ≠ FIXT 333 lm - 2700K/CRI 80 - 220-240V / 6W - 539 lm ≠ FIXT 358 lm - 3000K/CRI 80 - 220-240V / 6W - 577 lm ≠ FIXT 382 lm - 4000K/CRI 80 - 220-240V

2700K

Non Dimmable

- F010B21A001
- F010B21A006
- F010B21A012
- F010B21A018
- F010B21A030
- F010B21A033
- 1-10V
- F010B21B001
- F010B21B006
- F010B21B012
- F010B21B018
- F010B21B030
- F010B21B033

3000K

Non Dimmable

- F010B31A001
- F010B31A006
- F010B31A012
- F010B31A018
- F010B31A030
- F010B31A033
- 1-10V
- F010B31B001
- F010B31B006
- F010B31B012
- F010B31B018
- F010B31B030
- F010B31B033

4000K

Non Dimmable

- F010B41A001
- F010B41A006
- F010B41A012
- F010B41A018
- F010B41A030
- F010B41A033
- 1-10V
- F010B41B001
- F010B41B006
- F010B41B012
- F010B41B018
- F010B41B030
- F010B41B033

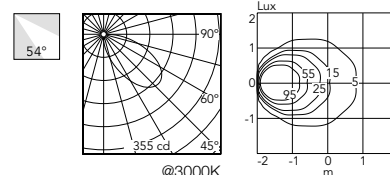

Walkstick 2

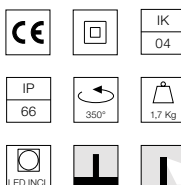
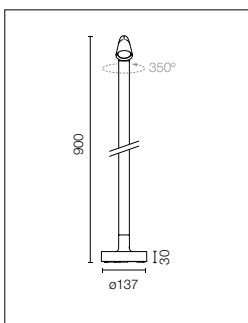

Sorgente luminosa a LED inclusa. Testa orientabile 350° sull'asse verticale e 350° sull'asse orizzontale. Alimentazione elettrica 220-240V ON/OFF e dimmabile 1-10V o DALI integrata. Dotato di uno spezzone di cavo uscente in neoprene e un sistema di giunzione IP68 H₂O Stop anti-condensa a 2 vie. Cassafornia per l'installazione a terra opzionale da ordinare separatamente. Versione 110V a richiesta.

LED light source included. Head adjustable 350° on both the vertical and horizontal axes. Integrated 220-240V ON/OFF and 1-10V or DALI dimmable electrical power. Equipped with a length of neoprene cable and an IP68 2-way anti-condensation H₂O stop seal system. Box for ground installation sold separately. 110V version by request.

2200K disponibile su richiesta.

2200K available on request.

Power Led: 6W - 502 lm ≠ FIXT 333 lm - 2700K/CRI 80 - 220-240V / 6W - 539 lm ≠ FIXT 358 lm - 3000K/CRI 80 - 220-240V / 6W - 577 lm ≠ FIXT 382 lm - 4000K/CRI 80 - 220-240V

2700K

Non Dimmable

- F010B22A001
- F010B22A006
- F010B22A012
- F010B22A018
- F010B22A030
- F010B22A033
- 1-10V
- F010B22B001
- F010B22B006
- F010B22B012
- F010B22B018
- F010B22B030
- F010B22B033

3000K

Non Dimmable

- F010B32A001
- F010B32A006
- F010B32A012
- F010B32A018
- F010B32A030
- F010B32A033
- 1-10V
- F010B32B001
- F010B32B006
- F010B32B012
- F010B32B018
- F010B32B030
- F010B32B033

4000K

Non Dimmable

- F010B42A001
- F010B42A006
- F010B42A012
- F010B42A018
- F010B42A030
- F010B42A033
- 1-10V
- F010B42B001
- F010B42B006
- F010B42B012
- F010B42B018
- F010B42B030
- F010B42B033

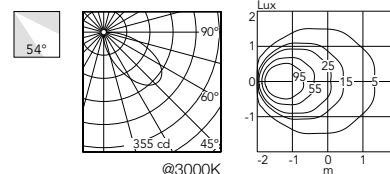

- Dali
- F010B22D001
 - F010B22D006
 - F010B22D012
 - F010B22D018
 - F010B22D030
 - F010B22D033

- Dali
- F010B32D001
 - F010B32D006
 - F010B32D012
 - F010B32D018
 - F010B32D030
 - F010B32D033

- Dali
- F010B42D001
 - F010B42D006
 - F010B42D012
 - F010B42D018
 - F010B42D030
 - F010B42D033

Walkstick 2 Double

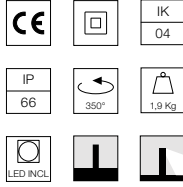
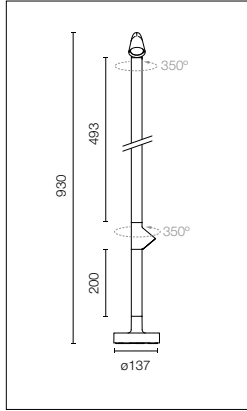

Doppia sorgente luminosa a LED inclusa. Teste orientabili indipendentemente 350° sull'asse verticale e 350° sull'asse orizzontale. Alimentazione elettrica 220-240V ON/OFF e dimmabile 1-10V o DALI integrata. Dotato di uno spezzone di cavo uscente in neoprene e un sistema di giunzione IP68 H₂O Stop anti-condensa a 2 vie. Cassaforma per l'installazione a terra opzionale da ordinare separatamente. Versione 110V a richiesta

Dual LED light source included. Heads independently adjustable 350° on both the vertical and horizontal axes. Integrated 220-240V ON/OFF and 1-10V or DALI dimmable electrical power. Equipped with a length of neoprene cable and an IP68 2-way anti-condensation H₂O stop seal system. Box for ground installation sold separately. 110V version by request.

2200K disponibile su richiesta.

2200K available on request.

Power Led: 8,5W - 502+264 lm ≠ FIXT 333+185 lm - 2700K/CRI 80 - 220-240V / 8,5W - 539+283 lm ≠ FIXT 358+199 lm - 3000K/CRI 80 - 220-240V / 8,5W - 577+303 lm ≠ FIXT 382+212 lm - 4000K/CRI 80 - 220-240V

2700K

Non Dimmable

- F010C22A001
- F010C22A006
- F010C22A012
- F010C22A018
- F010C22A030
- F010C22A033

1-10V

- F010C22B001
- F010C22B006
- F010C22B012
- F010C22B018
- F010C22B030
- F010C22B033

Dali

- F010C22D001
- F010C22D006
- F010C22D012
- F010C22D018
- F010C22D030
- F010C22D033

3000K

Non Dimmable

- F010C32A001
- F010C32A006
- F010C32A012
- F010C32A018
- F010C32A030
- F010C32A033

1-10V

- F010C32B001
- F010C32B006
- F010C32B012
- F010C32B018
- F010C32B030
- F010C32B033

Dali

- F010C32D001
- F010C32D006
- F010C32D012
- F010C32D018
- F010C32D030
- F010C32D033

4000K

Non Dimmable

- F010C42A001
- F010C42A006
- F010C42A012
- F010C42A018
- F010C42A030
- F010C42A033

1-10V

- F010C42B001
- F010C42B006
- F010C42B012
- F010C42B018
- F010C42B030
- F010C42B033

Dali

- F010C42D001
- F010C42D006
- F010C42D012
- F010C42D018
- F010C42D030
- F010C42D033

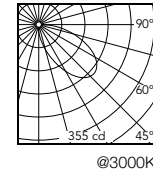

@3000K

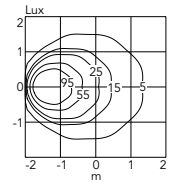

Walkstick: Accessori / Accessories

Cassaforma per l'installazione a terra. Box for ground installation.

F001Z020000

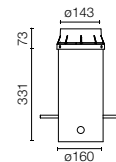

Dispositivo di protezione per il sovraccarico. 240Vac. Corrente massima di scarica 10KA (8/29us). Massima corrente operativa 5A. Adatto per la connessione in serie. IP66.

Surge protection device. 275Vac. Maximum discharge current 10KA (8/20us). Maximum operating current 5A. Suitable for series connection. IP66.

F990E00A000

