



















BEACONS

EB5100 Series Low Profile LED Beacon

The Low Profile R65 Beacon utilises powerful LEDs, arranged to produce a 360° flash pattern by combining the solid-state, maintenance free long-life nature of LED technology. With additional features including multiple flash patterns, synchronisation and vigorous testing to the ECCO standard and OEM specifications. This high-performance range has improved EMC performance to CISPR 25 level 3, is robust and compact in a popular housing design and is available in four standard mounting options. This range is designed to maximise resilience to excessive vibration, increasing the life of the product and is backed by our five-year no-hassle warranty.

Models

PART NO.	MOUNT	LENS	LED COLOUR
EB5101XX	Single Bolt	 	 
EB5102XX	3 Bolt	 	 
EB5103XX	DIN Pole	 	 
EB5104XX	Magnetic Mount	 	 

*Replace 'XX' in Part Number with desired colour lens (A = Amber, C = Clear) then colour LED (A = Amber, G = Green). Excludes Amber Green

Design Features

- Ultra compact, low profile beacon at 63mm tall
- 10-32V
- CISPR 25 Class 3 EMC performance
- SAE Class 1 Brightness
- Built tough with an aluminium base and reinforced polycarbonate lens
- 12 Flash Patterns, featuring ICAO
- Built to OEM specifications
- Four mounting options available - Single and 3 bolt, DIN pole or Magnetic
- Temperature Range: -30° to +50°C

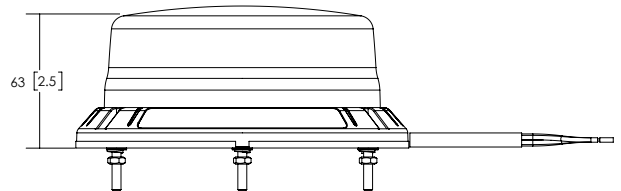
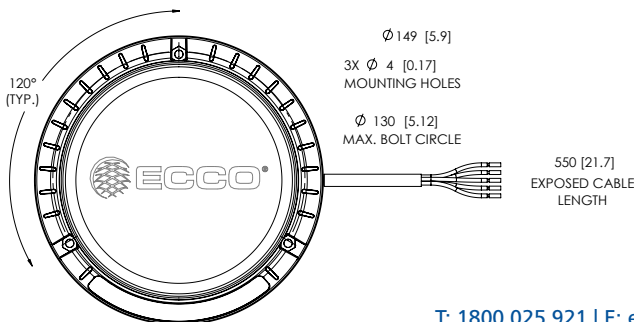

T: 1800 025 921 | E: esgapcs@esg.global