



**Cloud
Connector**

Quick Start Guide

**Install your Cloud Connector
in a few simple steps**

What's included

1



Cloud Connector

Remote
(batteries not included)

2

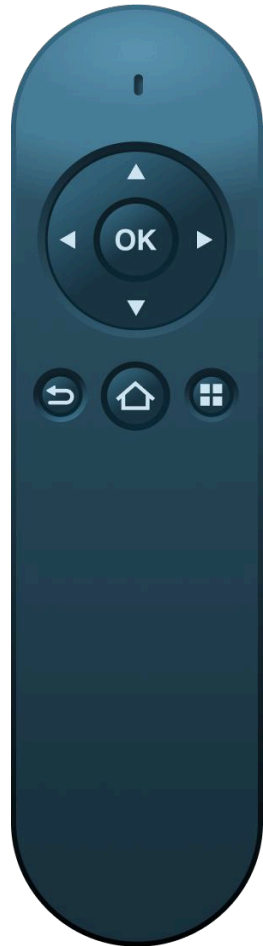

3

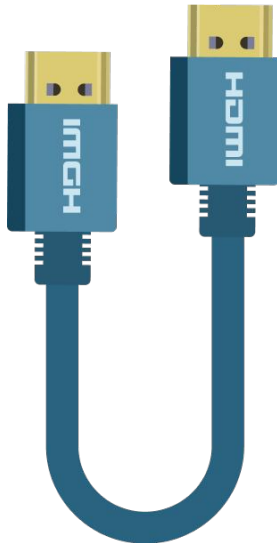

HDMI cable

4

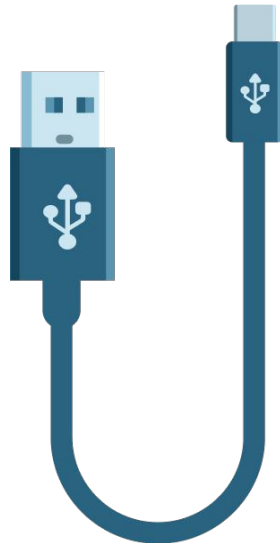

Type A &
Type C
USB cable

Here's what you need

1. TV with an available HDMI port.
2. USB socket capable of DC 5V 0.5A (minimum 2.5W) or use the one available on your TV.
3. A mobile device.
4. Home Internet connection.

1. Power the Cloud Connector

- Connect the Type A USB cable to the USB port on the TV.
- Connect the Type C USB cable to the Cloud Connector.

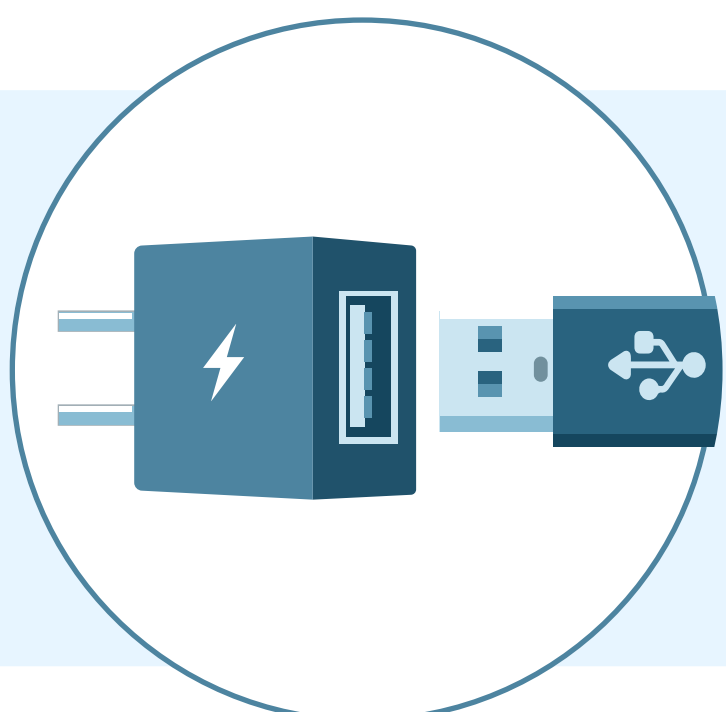
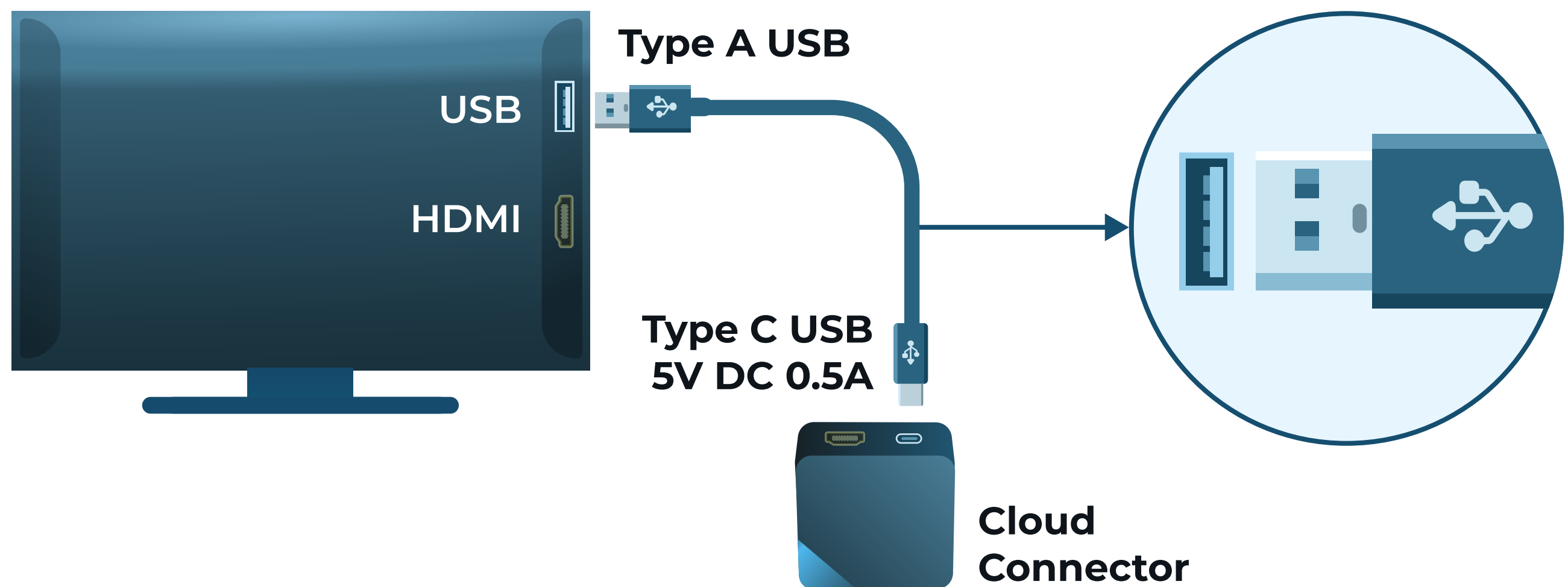

No USB Port on TV?
Use an external USB power adapter
rated at 5V DC 0.5A.

! Only use cable provided.

2. Connect to the TV

Connect the HDMI cable from the Cloud Connector into an available HDMI port on your TV.

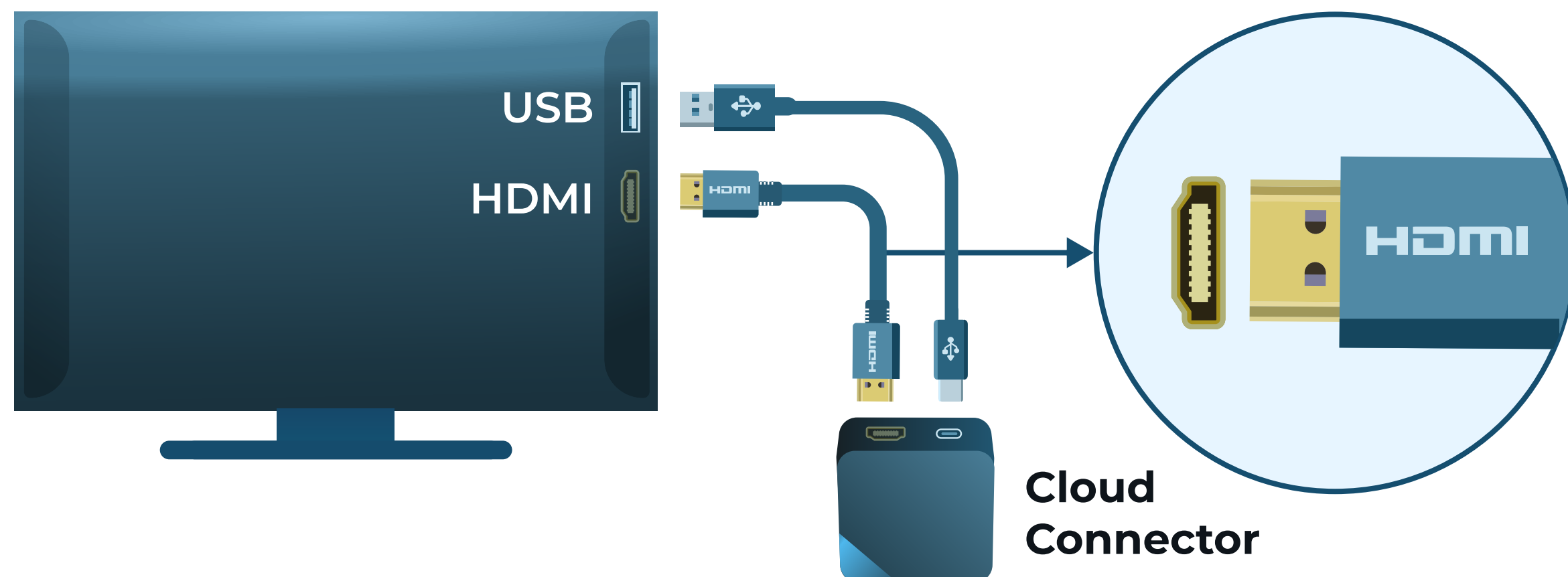

Ensure the connector is properly aligned with the port and gently push it in until it fits securely.

3. Switch TV input

1. Use your TV remote to turn on the TV.
2. Press the input/source button to select the input.



Look for the option that corresponds to the HDMI input that your Cloud Connector is plugged into (e.g., HDMI 1, HDMI 2).

When the correct input/source is chosen you'll see one of these screens.

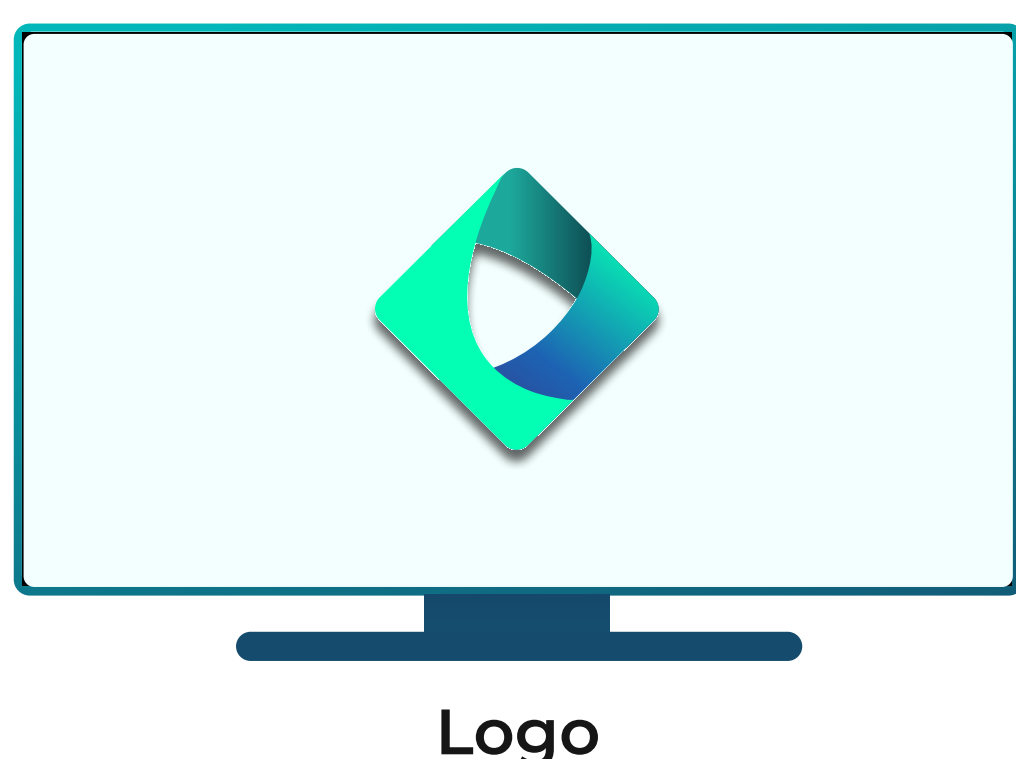

Logo

OR



Pair Remote

4. Insert remote batteries

1. Open the battery cover.
2. Insert the AAA batteries with the **+** and **-** ends facing as shown.
3. Close the battery cover.

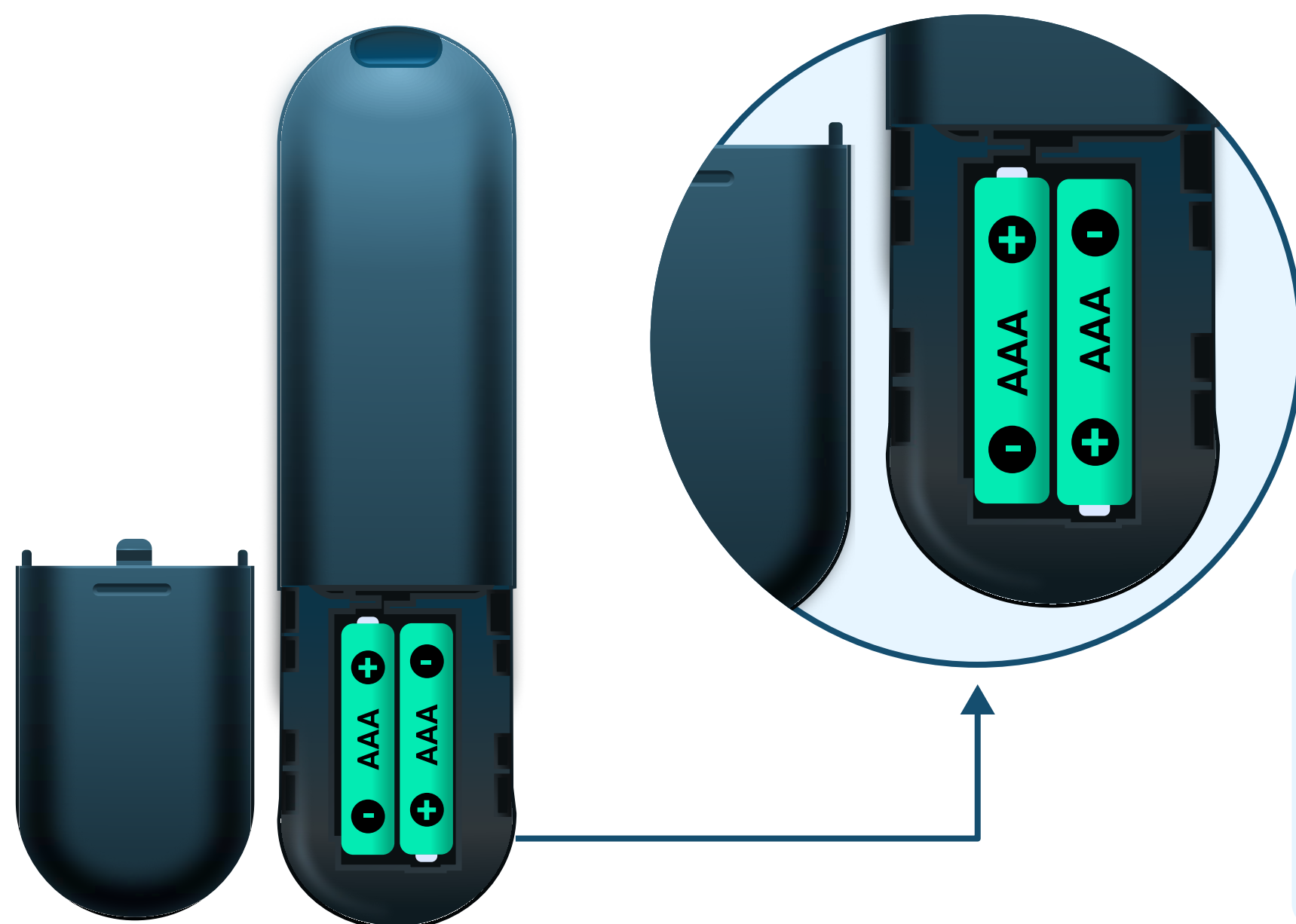

It is recommended to use a new pair of batteries to ensure optimal performance.

5. Pair the remote

Press and hold **◀** & **▶** buttons until the light at the top of your remote starts blinking.

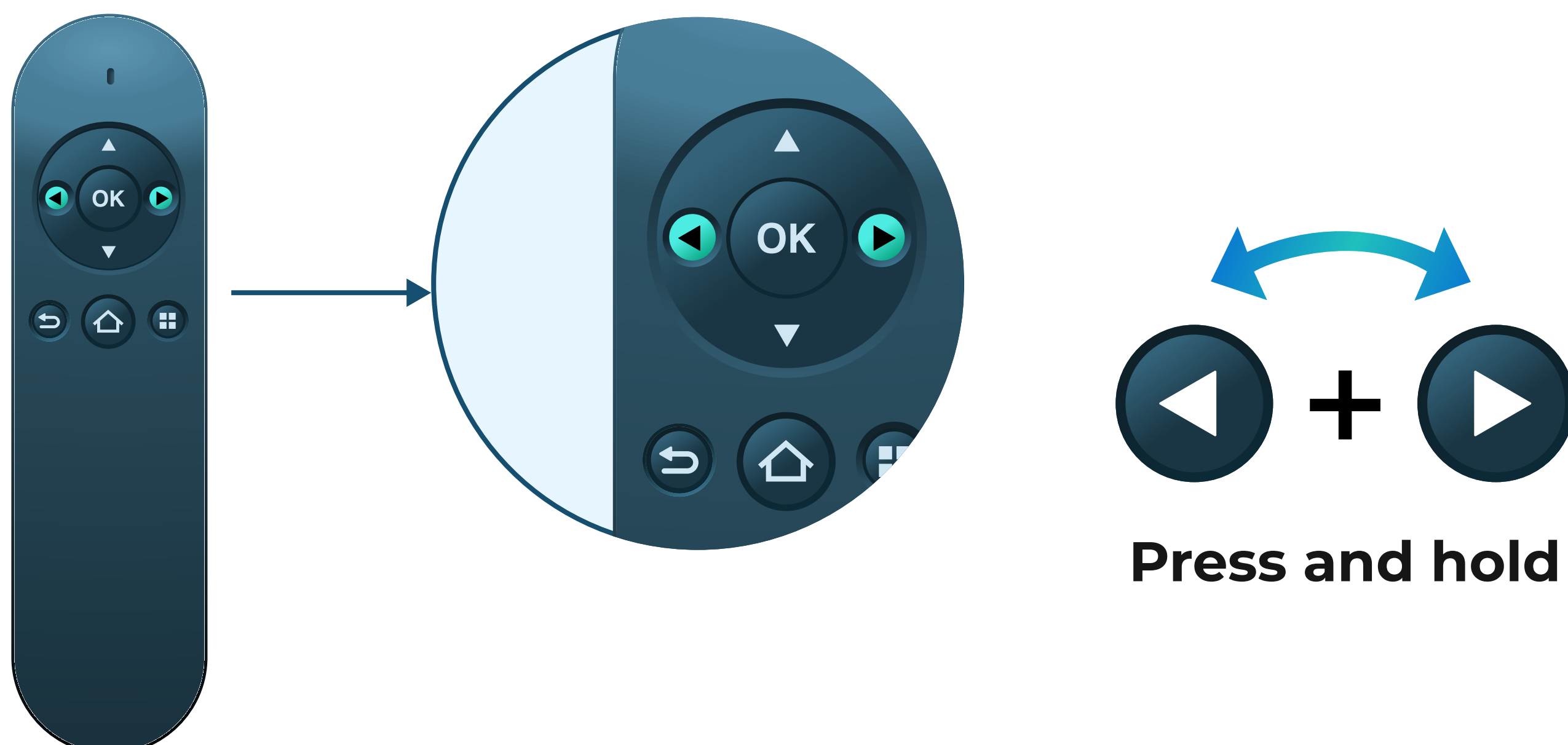

6. Install mobile app

Scan the QR code and install the app.

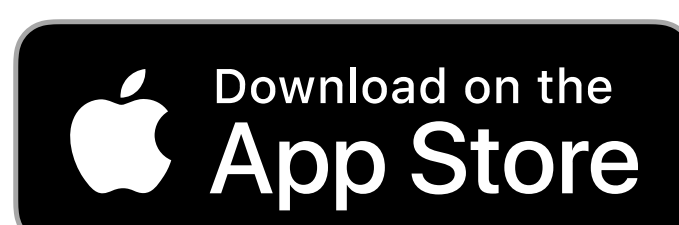

Connector

You can also search for 'Cloud Connector' and install the app using Google Play or App Store.

7. Setup the Cloud Connector

1. Open the mobile app.
2. When instructed, enter the six digit code shown on your TV screen.
3. Press 'Continue'.

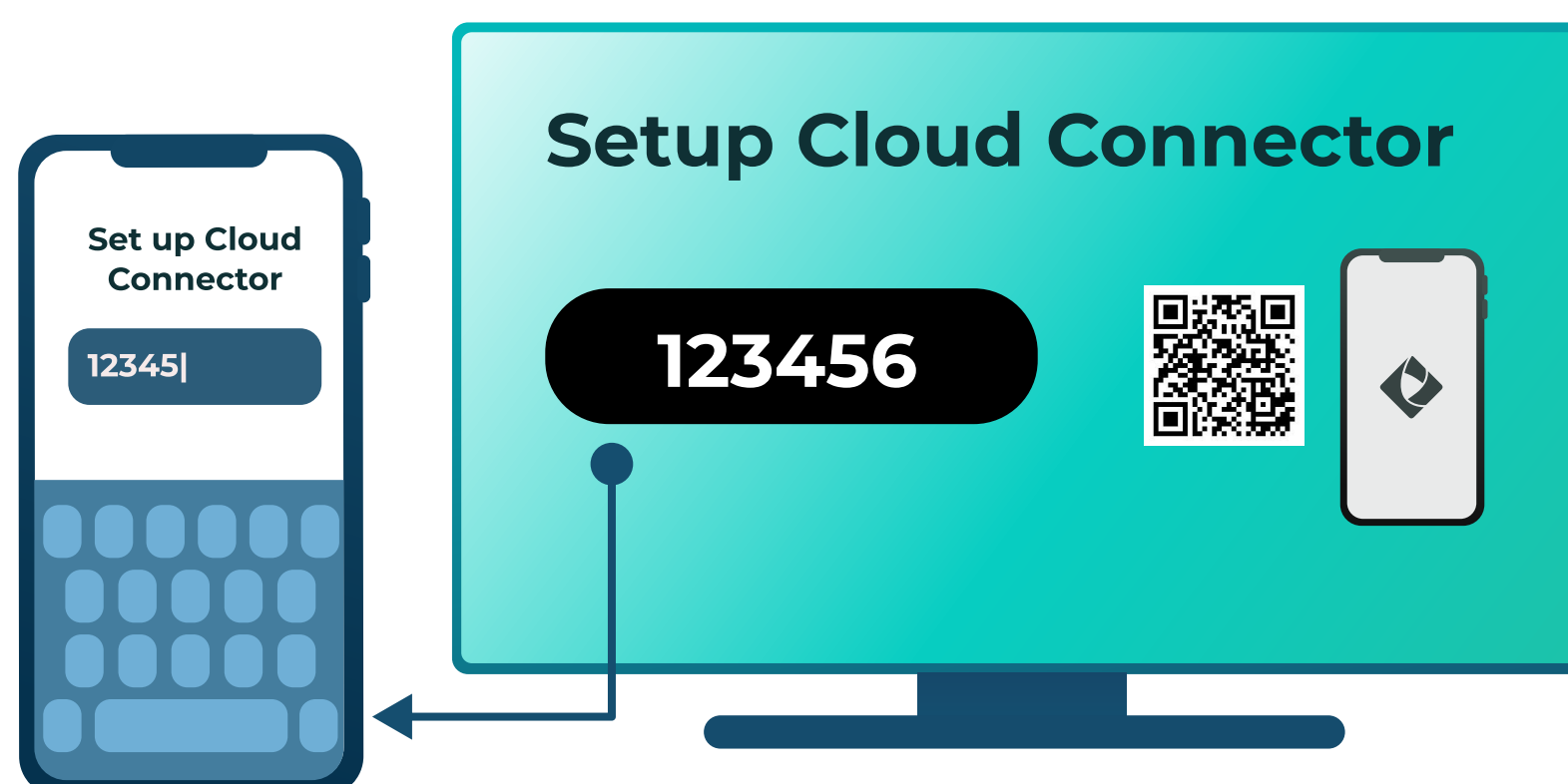

If you phone displays a list of Wi-Fi networks, please tap on connector-XXXXXX from the Wi-Fi listing screen, where 'XXXXXX' is the six digit number shown on your TV.

8. Connect to Wi-Fi

During the setup process, you will be prompted to connect your Cloud Connector to your Wi-Fi network.

1. Make sure you select the same network to which your mobile device or tablet is connected.
2. Please enter the password for the selected network.

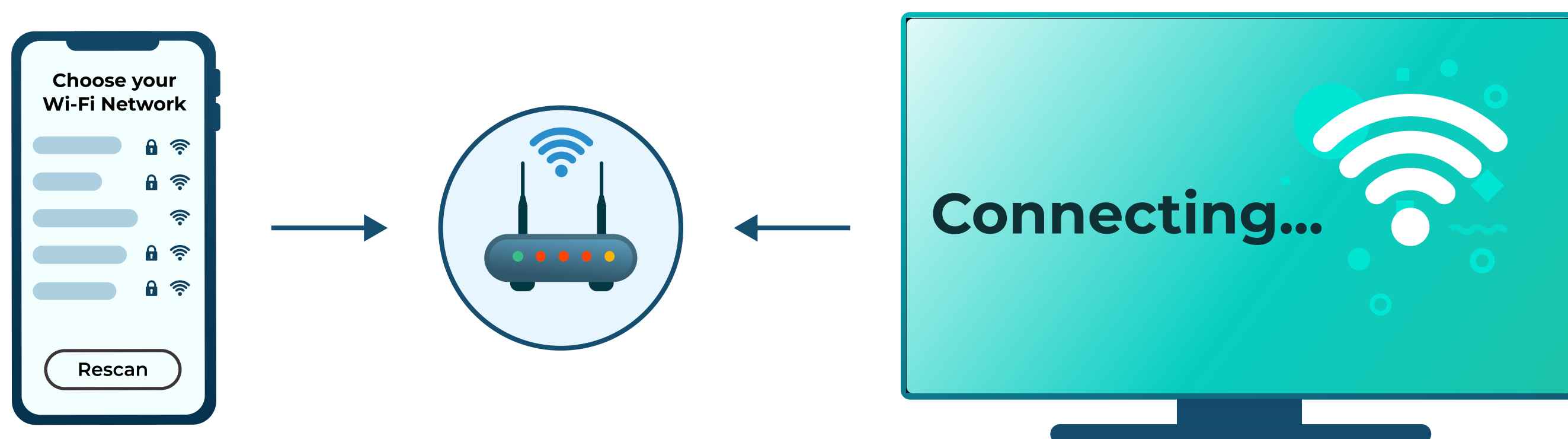

9. Software update

If a software update is available for your Cloud Connector, you will be prompted to update the device.

Press the **OK** button on your remote to update the device.

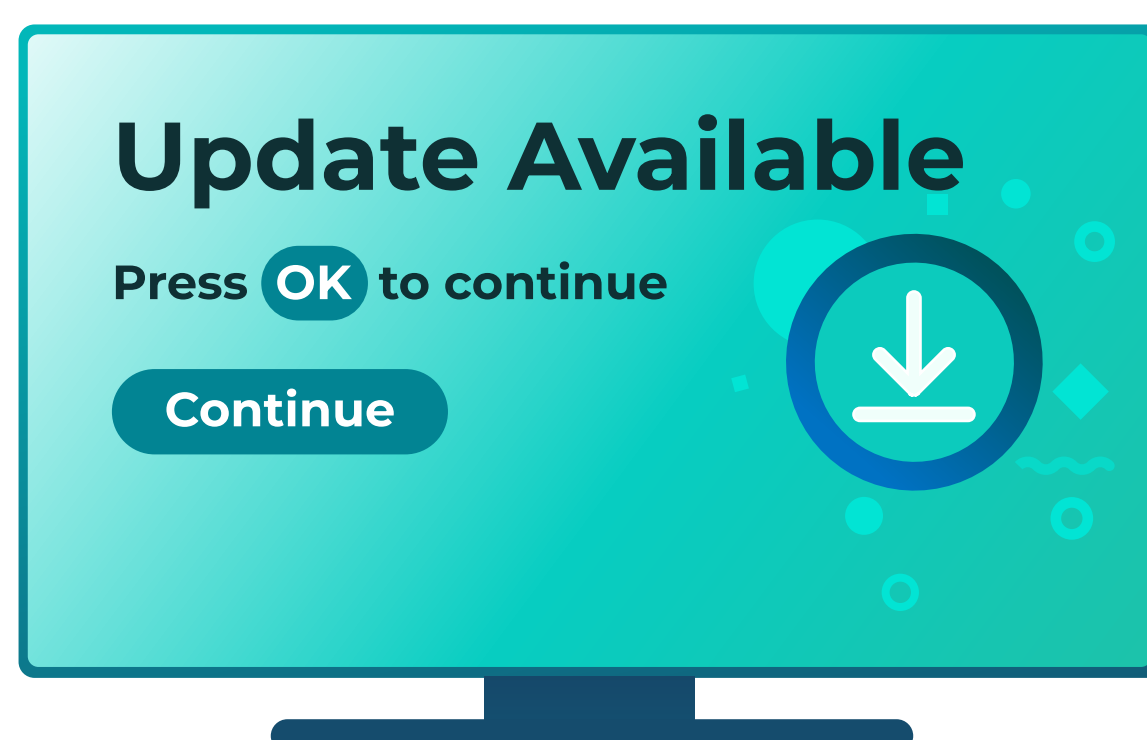

Please do not interrupt or power off the device while the update is in progress.

10. Congratulations! Setup complete

Restart Cloud Connector to complete the setup.

Press the  button on your remote to restart.

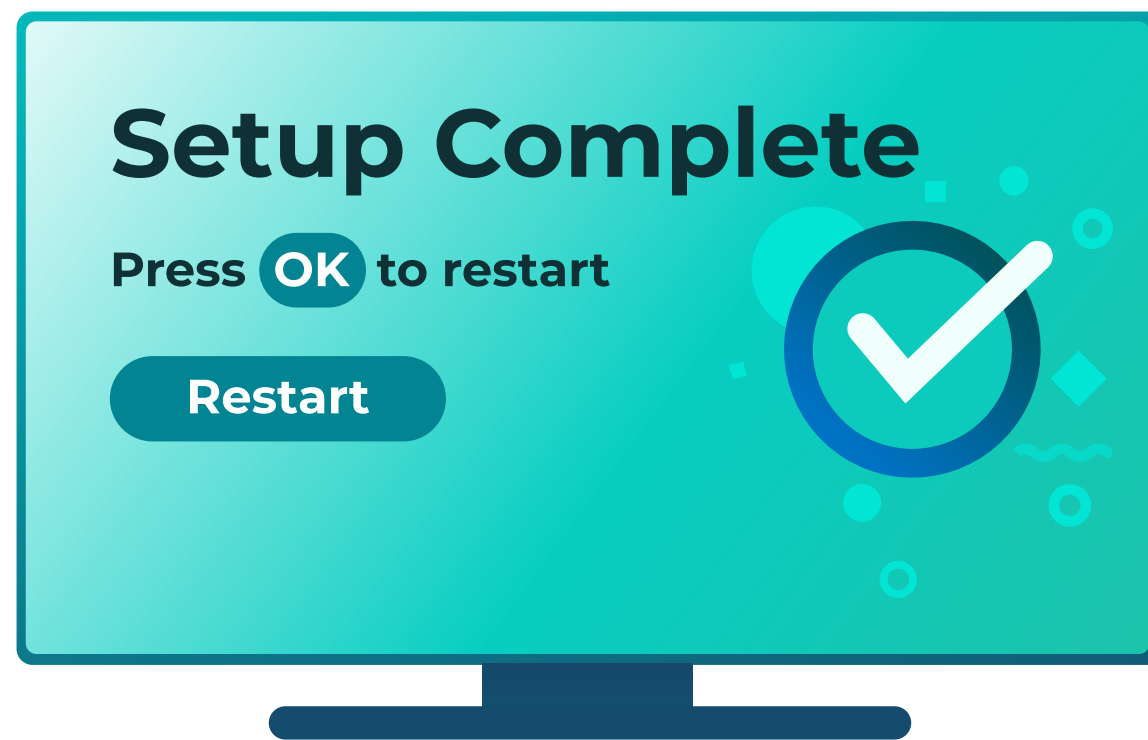

Troubleshooting

If you are experiencing issues with your Cloud Connector, scan the QR code displayed below to view our troubleshooting website.



Or visit our troubleshooting website at <https://cloudconnector.tv/help>

Frequently Asked Questions

<https://cloudconnector.tv/help/topics/frequently-asked-questions>

How to videos

<https://cloudconnector.tv/help/topics/how-to-videos>

Installation and set up

<https://cloudconnector.tv/help/topics/installation-setup>

Product details

Product Name: Senza Cloud Connector
RCU Name: Bluetooth Remote Control

Model Name: SZC004
Model Name: B042-01-W9

Importers

France

Synamedia Technologies France SAS
12 A Rue du Pâtis Tatelin,
35700 Rennes,
France
Co. Reg. # 818 627 580

UK

Synamedia Limited
51 Clivemont Rd,
Maidenhead
SL6 7BZ
Co. Reg. # 3080780

Manufacturer

Shenzhen SDMC Technology Co., Ltd
Address: Room 1022, Floor 10, Building A, Customs Building, No. 2, Xin'an 3rd Road,
Dalang Community, Xin'an Street, Bao'an District, Shenzhen, China

Frequency range

Frequency band:

Bluetooth: 2402MHz – 2480MHz

2.4G Wi-Fi: 2412MHz – 2472MHz

5G Wi-Fi: 5150MHz – 5250MHz, 5250MHz – 5350MHz,
5470MHz – 5725MHz, 5725MHz – 5850MHz

RF Effective Isotropic Radiated Power,EIRP:

Bluetooth: EIRP<20dBm

2.4G Wi-Fi: EIRP<20dBm

5G Wi-Fi: 5150-5250MHz: EIRP<23dBm

5250–5350MHz: EIRP<20dBm

5470-5725MHz: EIRP<20dBm

5725–5850MHz: EIRP<14dBm

For Senza Cloud Connector, the device complies with relevant RF radiation exposure limits when positioned at least 20cm away from your body.

For Bluetooth Remote Control, the device has been evaluated to meet general RF exposure requirement. The device can be used in portable exposure condition without restriction.

The WLAN function for this device is restricted to indoor use only when operating in the 5150 to 5350 MHz frequency range.

| | | | | | | | | | | | | |
|---|----|----|----|----|----|----|----|----|--------|----|----|----|
|  | AT | BE | BG | CH | CY | CZ | DK | DE | EE | EL | ES | FI |
| | FR | HR | HU | IE | IS | IT | LI | LT | LU | LV | MT | NL |
| | NO | PL | PT | RO | SE | SI | SK | TR | UK(NI) | | | |

| | |
|---|----|
|  | UK |
| | |



This product bears the selective sorting symbol for Waste Electrical and Electronic Equipment (WEEE). This means that this product must be handled pursuant to European directive 2012/19/EU in order to be recycled or dismantled to minimize its impact on the environment.

User has the choice to give his product to a competent recycling organization or to the retailer when he buys a new electrical or electronic equipment.

FCC Statement

This equipment has been tested and found to comply with the limits for a Class B digital device, pursuant to part 15 of the FCC Rules. These limits are designed to provide reasonable protection against harmful interference in a residential installation. This equipment generates, uses and can radiate radio frequency energy and, if not installed and used in accordance with the instructions, may cause harmful interference to radio communications. However, there is no guarantee that interference will not occur in a particular installation. If this equipment does cause harmful interference to radio or TV reception, which can be determined by turning the equipment off and on, the user is encouraged to try to correct the interference by one or more of the following measures:

- Reorient or relocate the receiving antenna.
- Increase the separation between the equipment and receiver.
- Connect the equipment into an outlet on a circuit different from that to which the receiver is connected.
- Consult the dealer or an experienced radio/TV technician for help.

FCC Radiation Exposure Statement

For Senza Cloud Connector, the device complies with FCC radiation exposure limits set forth for an uncontrolled environment. The distance between user and products should be no less than 20cm.

For Bluetooth remote control, the device has been evaluated to meet general RF exposure requirement. The device can be used in portable exposure condition without restriction.

This device complies with Part 15 of the FCC Rules. Operation is subject to the following two conditions:

- (1) This device may not cause harmful interference, and
- (2) This device must accept any interference received, including interference that may cause undesired operation.

Caution!

Any changes or modifications not expressly approved by the party responsible for compliance could void the user's authority to operate the equipment.

Shielded cables must be used with this unit to ensure compliance with the Class B FCC limits.

Caution!

Risks of explosion if the battery is replaced by an incorrect type:

- Replacement of a battery with an incorrect type that can defeat a safeguard (for example, in the case of some lithium battery types)
- Disposal of a battery into fire or a hot oven, or mechanically crushing or cutting of a battery, that can result in an explosion
- Leaving a battery in an extremely high temperature surrounding environment that can result in an explosion or the leakage of flammable liquid or gas
- A battery subjected to extremely low air pressure that may result in an explosion or the leakage of flammable liquid or gas.

Operating Temperature: 0°C ~ 40°C