

SKINTOP® MS-M ATEX

SKINTOP® MS-M ATEX, anti-static brass cable gland with cold impact resistance and maximum reliability, explosion-proof

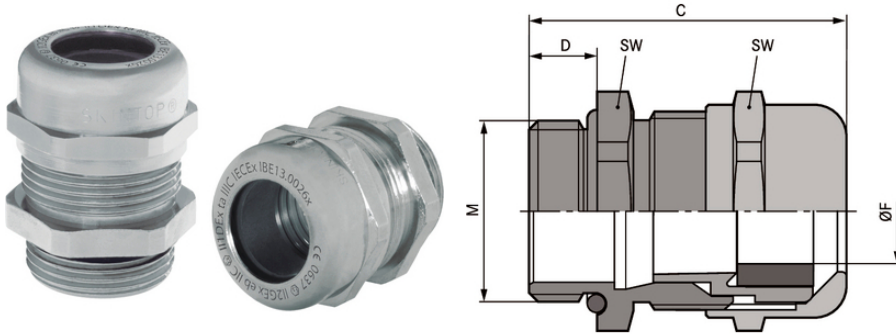

Oil & Gas



Good chemical resistance



Mechanical resistance



Optimum strain relief



Reliability



Variety of approval certifications

Benefits

Cold impact resistance
 High strain relief
 Wide, variable clamping ranges
 Maximum reliability

Application range

Devices, machines and apparatus of enhanced safety protection type "e", dust ignition proof "t"
 Equipment group II / Category 2G+1D
 For mobile applications in offshore and marine industries
 Chemical and petrochemical industry

Product features

Last Update (18.12.2024)
 ©2024 Lapp Group - Technical changes reserved
 Product Management www.lappkabel.de
 You can find the current technical data in the corresponding data sheet.
 PN 0456 / 02_03.16

SKINTOP® MS-M ATEX

SKINTOP® MS-M-XL ATEX is similar to the SKINTOP® MS-M ATEX, but has an extended connection thread for thick walls

Norm references / Approvals

UL File Nr. E79903

M 63 plus without UL approval

Product Make-up

Metric connection thread acc. to DIN EN 60423

Basis for technical information DIN IEC 62444

Technical Data

Classification ETIM 5:

ETIM 5.0 Class-ID: EC000441

ETIM 5.0 Class-Description: Cable screw gland

Classification ETIM 6:

ETIM 6.0 Class-ID: EC000441

ETIM 6.0 Class-Description: Cable screw gland

Caution:

Refer to the instruction leaflet for the installation dimensions and torques

Certifications:

CE 0637 Ex II 2G

Ex eb IIC Ex II 1D

Ex ta IIIC

IECEx IBE 13.0026X

Material:

Body: nickel-plated brass

Insert: polyamide

Sealing: CR

O-ring: NBR

Tests:

DIN EN 60079-0

DIN EN 60079-7

DIN EN 60079-31

Protection rating:

IP 68 - 10 bar

IP 66

NEMA Type 1, 4x, 6, 12

Temperature range:

-30°C to +90°C

Note

Photographs and graphics are not to scale and do not represent detailed images of the respective products.

Prices are net prices without VAT and surcharges. Sale to business customers only.

**SKINTOP® MS-M ATEX**

Article number	Article designation / size	Ø F mm	SW wrench size mm	Overall length C mm	Thread length D mm	Pieces / PU
SKINTOP® MS-M-XL ATEX						
53112800	M 12 x 1,5	3.0 - 7.0	16	32.0	12	100
53112810	M 16 x 1,5	4.5 - 10.0	20	38.0	12	100
53112820	M 20 x 1,5	7.0 - 13.0	24	41.0	12	50
53112830	M 25 x 1,5	9.0 - 17.0	29	42.5	12	25
53112840	M 32 x 1,5	11.0 - 21.0	36	51.5	15	25
53112850	M 40 x 1,5	19.0 - 28.0	45	54.0	15	10
53112860	M 50 x 1,5	26.0 - 35.0	54	60.5	15	5
SKINTOP® MS-M ATEX						
53112700	M 12 x 1,5	3.0 - 7.0	16	26.5	6.5	100
53112710	M 16 x 1,5	4.5 - 10.0	20	33.0	7	100
53112720	M 20 x 1,5	7.0 - 13.0	24	37.0	8	50
53112730	M 25 x 1,5	9.0 - 17.0	29	38.5	8	25
53112740	M 32 x 1,5	11.0 - 21.0	36	45.5	9	25
53112750	M 40 x 1,5	19.0 - 28.0	45	48.0	9	10
53112760	M 50 x 1,5	26.0 - 35.0	54	55.5	10	5
53112770	M 63 x 1,5	34.0 - 45.0	67	67.0	15	5
53112779	M 63 x 1,5 plus	44.0 - 55.0	75	65.5	15	1

Last Update (18.12.2024)

©2024 Lapp Group - Technical changes reserved

Product Management www.lappkabel.deYou can find the current technical data in the corresponding data sheet.
PN 0456 / 02_03_16