



PERPENDICULAR CHANNEL INSTALLATION AND MAINTENANCE GUIDELINES- PYRAMAT® 25

Thank you for purchasing the Pyramat® 25 Turf Reinforcement Mat (TRM) by Propex Operating Company, LLC (Propex). This document provides installation and maintenance guidelines for Pyramat® 25 used as channel armouring to increase channel resiliency towards forces created by high velocities and shear stresses. Pyramat® 25 provides permanent erosion protection on the side slopes and/or bed of a channel.

Temporary securing pins (pins) are used during installation to hold Pyramat® 25 in place. Pins also promote vegetation establishment keeping Pyramat® 25 in intimate contact with the soil.

Pyramat® 25 is an engineered solution with a unique design for each specific project. While Propex has made every effort to ensure general validity, this information should not be used for a specific application without independent professional examination and verification of its suitability, applicability, and accuracy. The documentation provided herein is for general information only, and is intended to present installation guidance only. Project specific contract documents take precedence when pin placements are different than what is represented in this document. Depending upon the critical nature of the structure to be armoured, work restrictions may be in place such as limiting installation based on growing seasons, weather patterns, etc. Work should be performed under the provisions set forth for the specific project. Please feel free to call our local Global Synthetics representative, refer www.globalsynthetics.com.au for support during installation as required.

BEFORE INSTALLATION BEGINS

- Coordinate with a Global Synthetics Representative: A pre-construction meeting with the construction team and a representative from Global Synthetics is recommended prior to installation. This meeting should be scheduled by the contractor with sufficient notice prior to construction.
- Gather the Tools Needed: Tools that you will need to install Pyramat® 25 include a pair of industrial shears to cut Pyramat® 25, tape measure, and a mallet or hammer.
- Determine Vegetation Establishment Strategy: The method of vegetation establishment should be determined prior to the start of installation. Different vegetation establishment methods require different orders of installation. Refer to Establish Vegetation for further guidance.

INSTALLATION OF PYRAMAT® 25 FOR CHANNELS

PREPARE THE SITE

It is recommended during all stages of site preparation that disturbed soils remain unprotected for not more than a single day. Depending on project size this may require progressive site preparation during installation.

1. Grade and compact the area in the channel where Pyramat® 25 will be installed. The channel surface should be uniform and smooth, having deleterious matter such as rocks, clods, vegetation or other objects removed so that during Pyramat® 25 laydown, Pyramat® 25 comes in direct, intimate contact with the channel surface.



2. Prepare the area to be armoured with Pyramat® 25 by loosening the topsoil to promote better vegetation establishment. This may be accomplished with a rotary tiller on slopes 3:1 or flatter. For slopes greater than 3:1, prepare topsoil in a safe manner.
3. Excavate an Initial Channel (IC) trench a minimum of 300 mm deep x 300 mm wide across the channel at the downstream end of the project (Figure 1). Deeper IC trench and/or hard armouring may be required for channels that have the potential for scour.

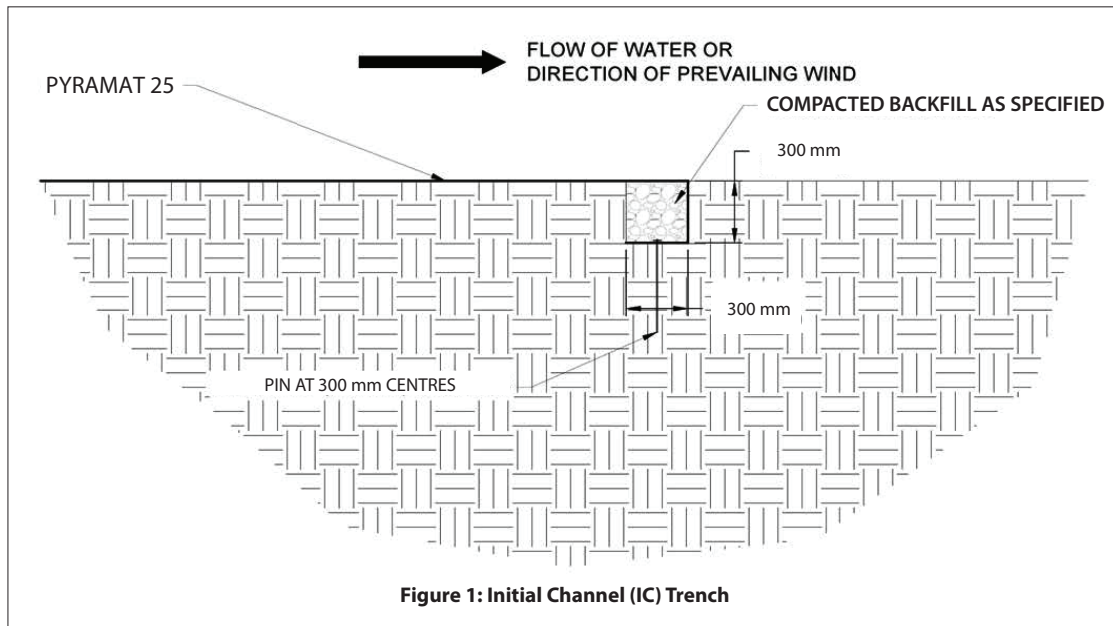

4. Excavate a Crest of Slope (COS) trench a minimum of 300 mm deep x 300 mm wide along both sides of the installation. Each COS trench must be a minimum of 900 mm over the crest of the bank, preferably on a relatively flat surface (Figure 2).

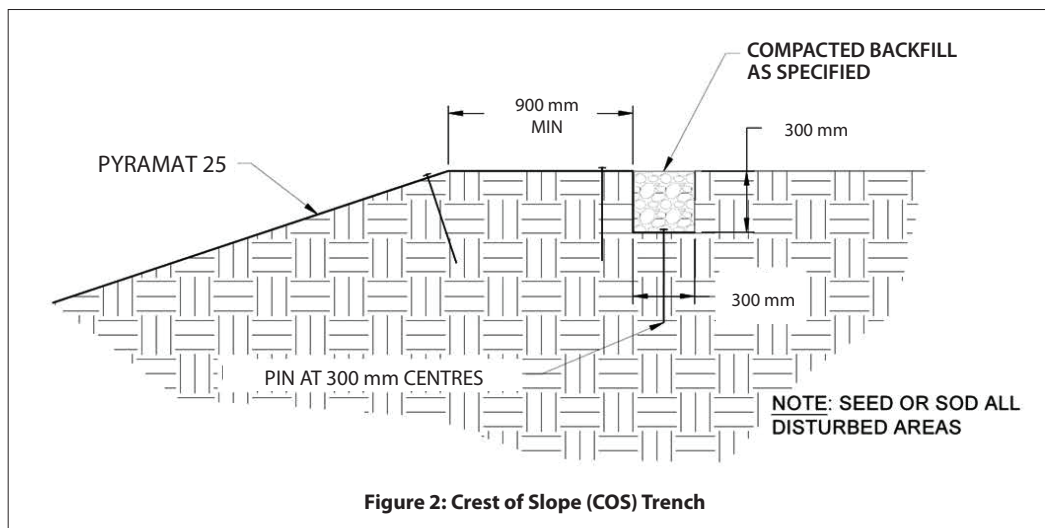

- Excavate a Terminal Channel (TC) trench a minimum of 300 mm deep x 300 mm wide across the channel at the upstream end of the project (Figure 3). Deeper TC trench and/or hard armouring may be required for channels that have the potential for scour.

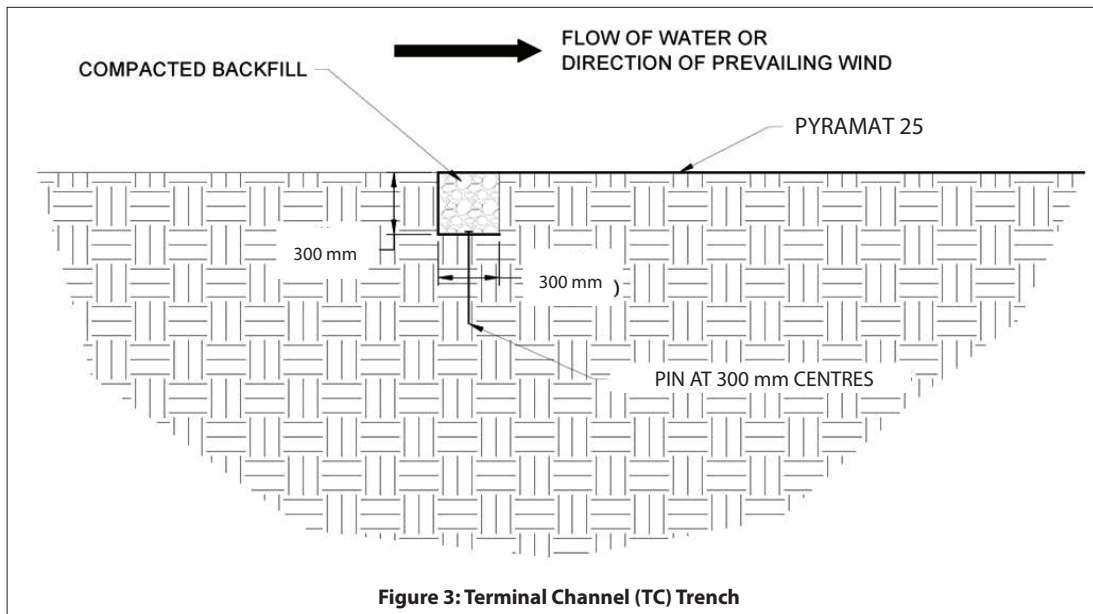

- If seeding, refer to Vegetation Establishment for additional considerations during site preparation.

PYRAMAT® 25 LAYDOWN

- Starting with the downstream end of the site select one of the COS trenches to begin the Pyramat® 25 Laydown process. To ensure proper anchoring of the overlapped areas the proceeding roll width must be laid out before the current roll width can be anchored with exception to the final roll width at the TC trench. For straight sections of a channel, Pyramat® 25 panel lengths should be long enough to construct both COS trenches while also covering the surface of the channel being armoured. (Figure 17) Panel edges should rest perpendicular to the channel centre line. For best results, panels of Pyramat® 25 should be continuous and free from seams or roll end overlaps that are parallel to the centre line of the channel. Panel edge overlapping should follow a pattern of placing each proceeding panel's edge over the top of the previous panel edge, shingling the panels in the direction of the water flow.

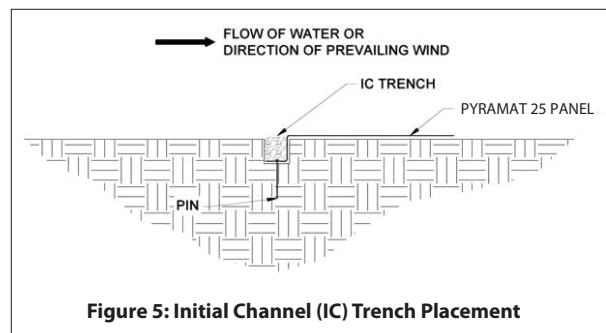
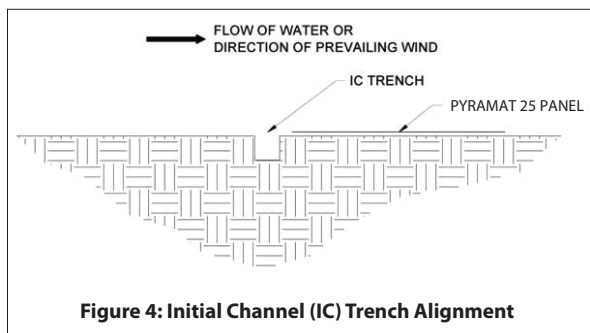

- Lay the Pyramat® 25 panel on the downstream side of the IC trench (Figure 4). Place the panel edge in the IC trench, ensuring full coverage along the bottom of the entire IC trench with the Pyramat® 25 (Figure 5).
- Secure Pyramat® 25 with pins in the IC trench (Figure 5). Pins should be U pins with a minimum leg length of 150 mm and shall be made of mild steel minimum 4 mm in diameter. (Figure 6) Longer pins may be required for looser soils. Heavier metal stakes may be required in rocky soils. Suggested placement of pins for the IC trench is along the bottom of the trench with pins on 300 mm.
- Backfill and compact the IC trench (Figure 5).
- Fold the Pyramat® 25 panel over the top of the compacted IC trench (Figure 7) and place each panel end into the respective COS trenches.
- Place the next Pyramat® 25 panel by laying the Pyramat® 25 roll so that the roll end points towards the COS trench (Figure 8), with a 75 mm overlap created at adjacent panel edge locations. Ensure that adjacent panel edges maintain a minimum 75 mm overlap during Pyramat® 25 laydown. (Figure 12)



Figure 6: Securing Pin

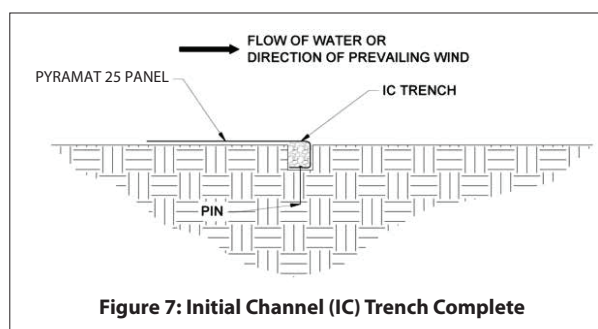

Figure 7: Initial Channel (IC) Trench Complete

- Secure Pyramat® 25 with pins in the COS trench (Figure 9). Suggested placement of pins for the COS trench is along the bottom of the trench at 300 mm centres. Pins should also be installed on panel edge overlaps in the COS trench.

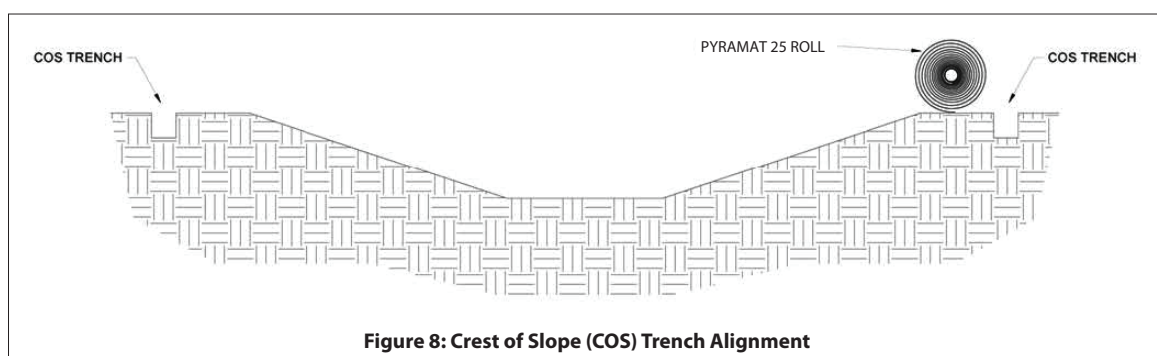
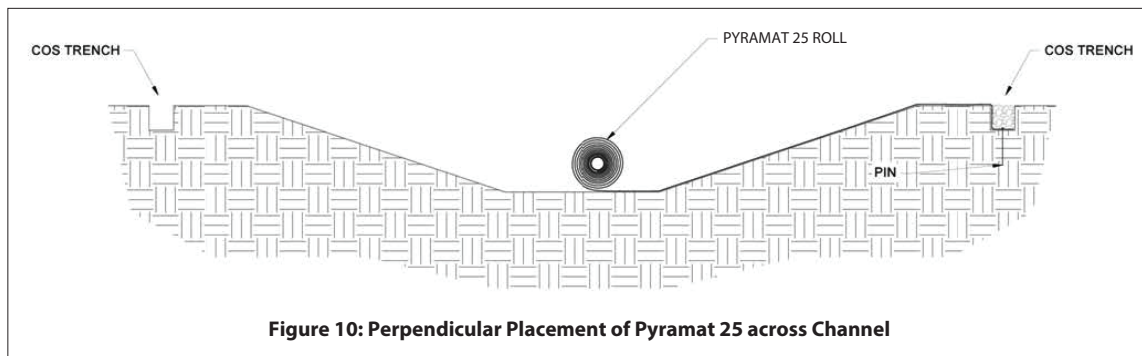
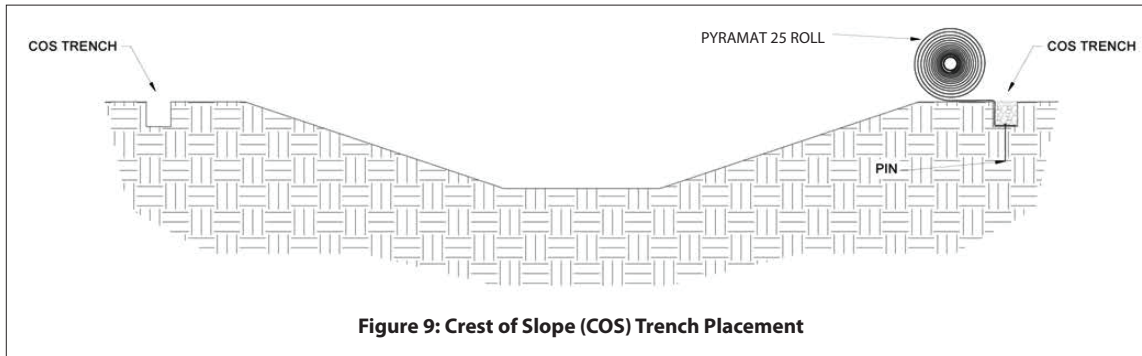
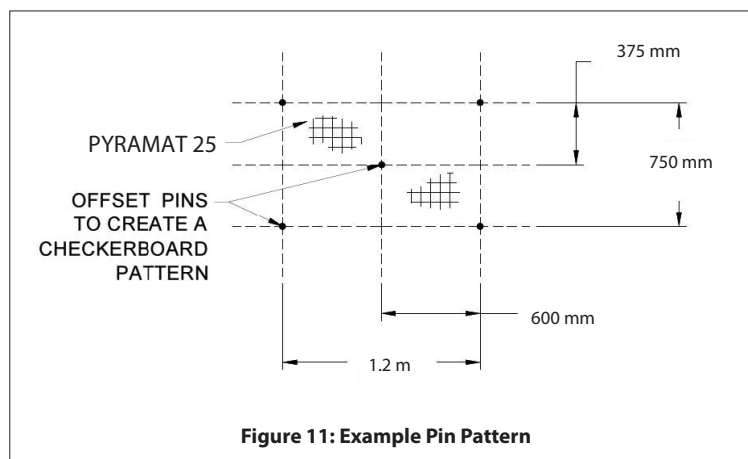

Figure 8: Crest of Slope (COS) Trench Alignment





8. Backfill and compact the COS trench in the location of the first Pyramat® 25 panel only (Figure 9).
 9. Unroll the Pyramat® 25 roll on the channel surface in the area to be armoured. (Figure 10) Ensure that Pyramat® 25 has intimate contact with the ground and all irregular surfaces beneath Pyramat® 25 are removed.
 10. Secure Pyramat® 25 panels in place using pins across the channel surface according to the project's engineered design. Pin placement should reflect a staggered checkerboard pattern across the channel surface for best results (Figure 11 and Figure 12).
- Roll edges shall be overlapped a minimum of 75 mm with pins placed on 300 mm centres (Figure 12).



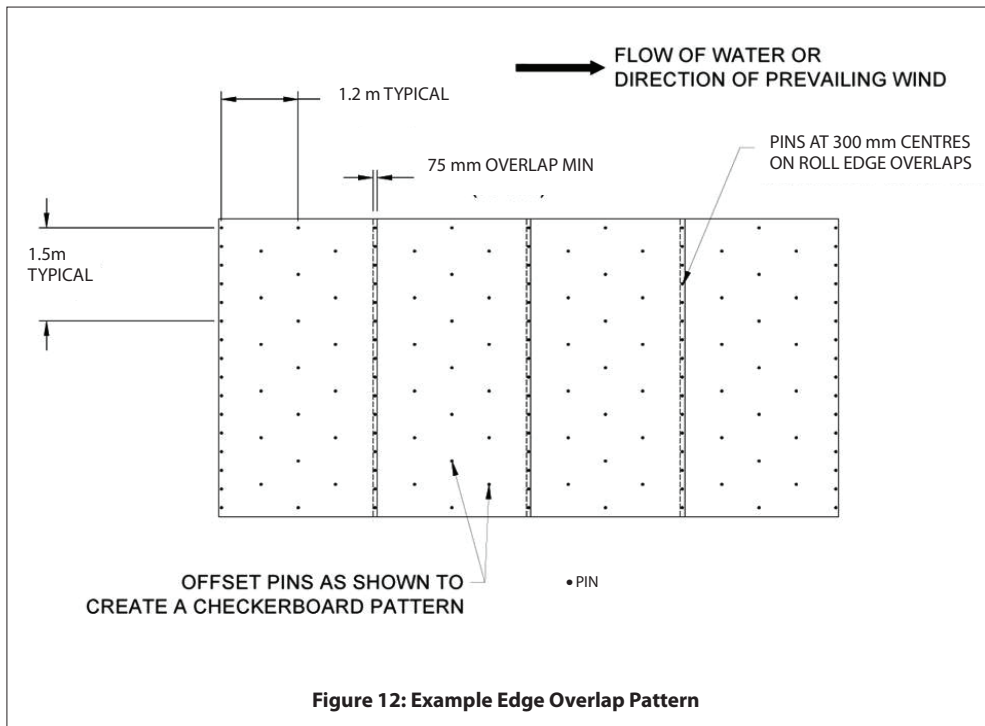

- Roll ends shall be overlapped a minimum of 150 mm with upstream panel on top. Secure roll end overlaps with two rows of pins staggered 150 mm apart on 300 mm (Figure 14).

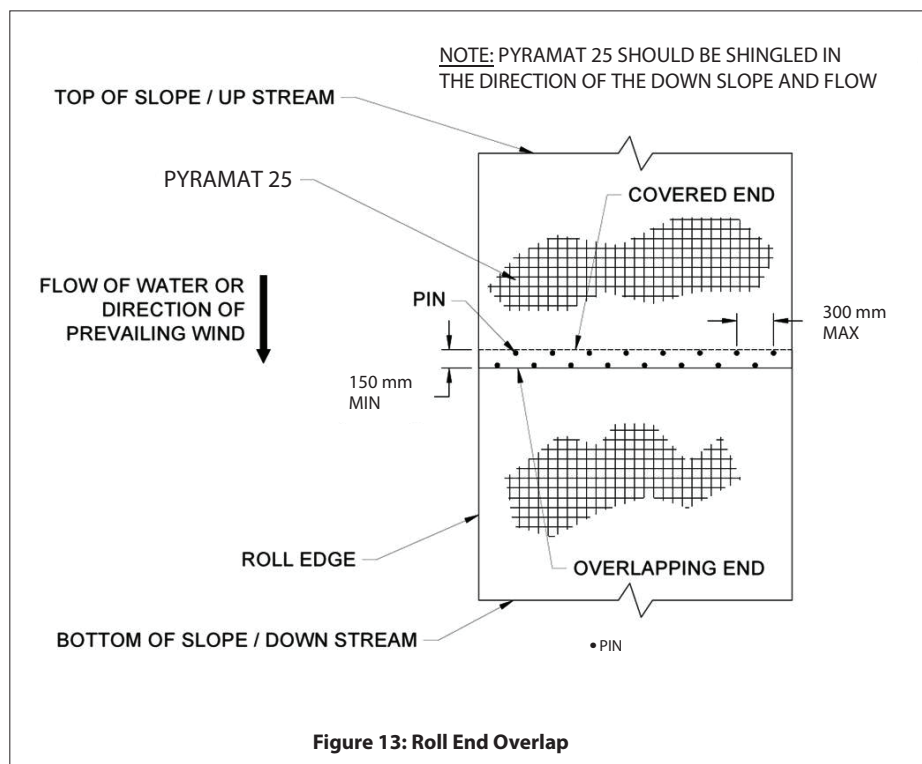

- For channel bank heights or channel bottom widths greater than 13.5 m, install simulated check slots. This method includes placing two rows of pins 300 mm apart on 300 mm centres at 13.5 m maximum intervals or across the midpoint of the slope for slope lengths less than 18 m (Figure 14).

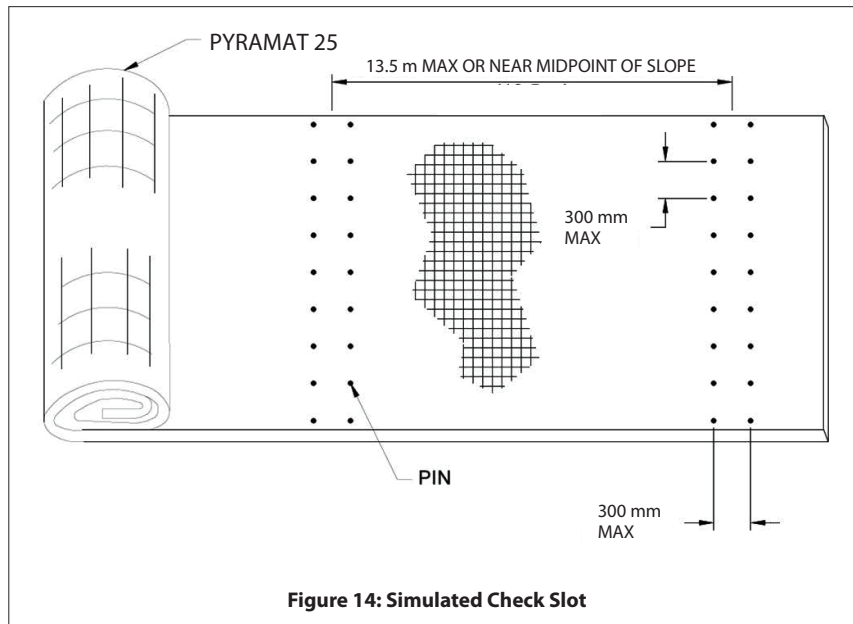

- At the break in slope interface towards the channel bed, it is suggested that Pins be installed on 300 mm centres (Figure 15).

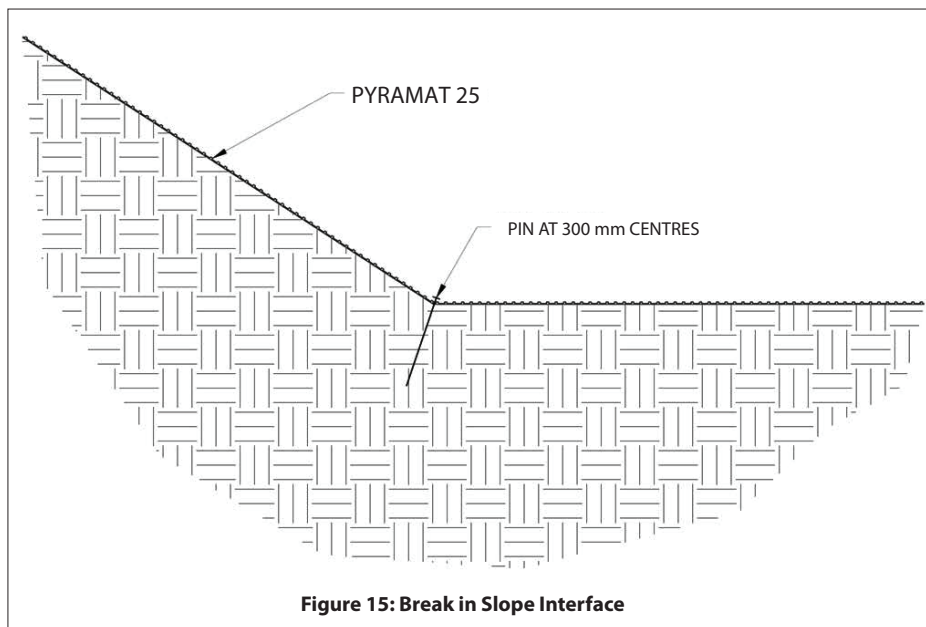

11. Secure Pyramat® 25 with pins in the opposite COS trench. Suggested placement of pins for the opposite COS trench is along the bottom of the trench at 300 mm centres (Figure 16).
12. Backfill and compact the opposite COS trench in the location of the first Pyramat® 25 panel only (Figure 16).

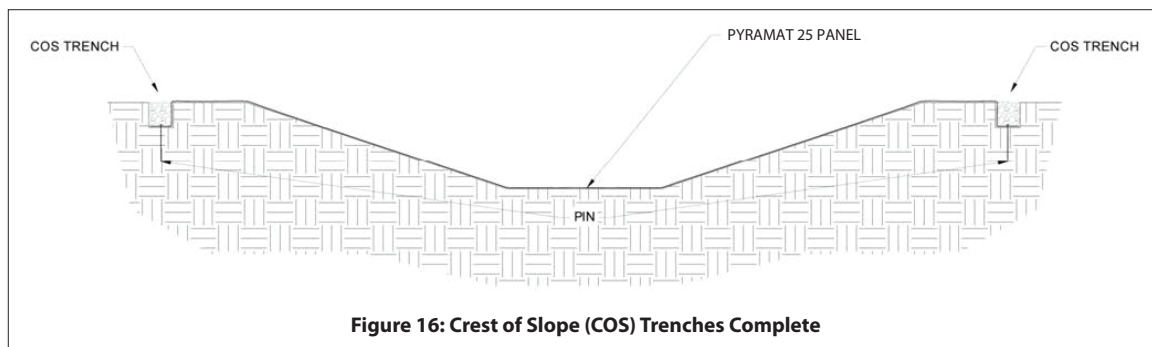

13. Continue to work down the length of the channel by repeating steps 6 through 9 overlapping each adjacent Pyramat® 25 panel by 75 mm (Figure 12). The last Pyramat® 25 panel should terminate on the Terminal Channel (TC) trench with pins at 300 mm centres.
14. Lay the last Pyramat® 25 panel on the upstream side of the TC trench (Figure 18). Place the panel edge in the TC trench, ensuring full coverage along the bottom of the entire TC trench with the Pyramat® 25 (Figure 18).
15. Secure Pyramat® 25 with pins in the TC trench. Suggested placement of pins for the TC trench is along the bottom of the trench with pins on 300 mm centres (Figure 18).

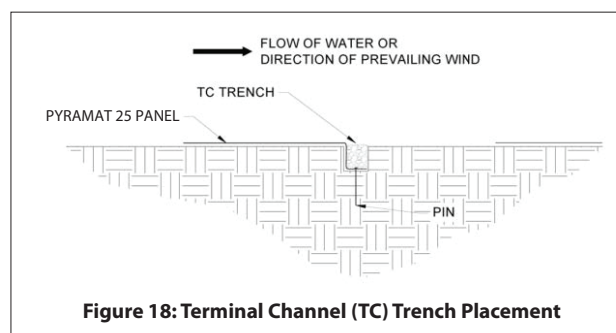
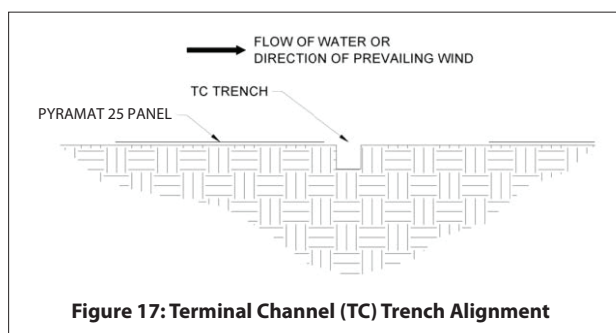

16. Backfill and compact the TC trench (Figure 18).
17. Fold the Pyramat® 25 panel over the top of the compacted TC trench (Figure 20) ensuring a minimum 75 mm overlap and place each panel end into the respective COS trenches.



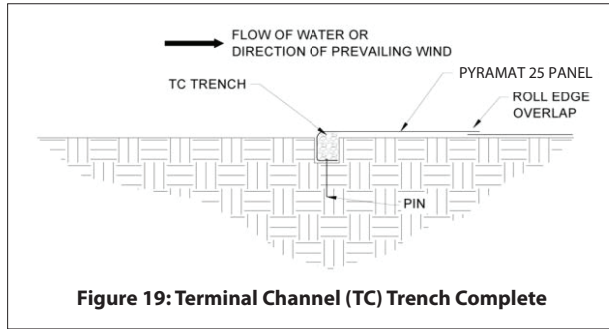

18. At a minimum, Pyramat® 25 panels should be pinned entirely across the channel surface, pins should be installed in the trenches, and the trenches should be backfilled and compacted at the end of each day to minimize rework in the case of a major rain event. Specific project conditions may warrant further evaluation of installation order for ease. An example isometric view (Figure 20) of a channel armoured with Pyramat® 25 can be seen below for overall reference. Consult Global Synthetics at www.globalsynthetics.com.au with any questions that you may have.

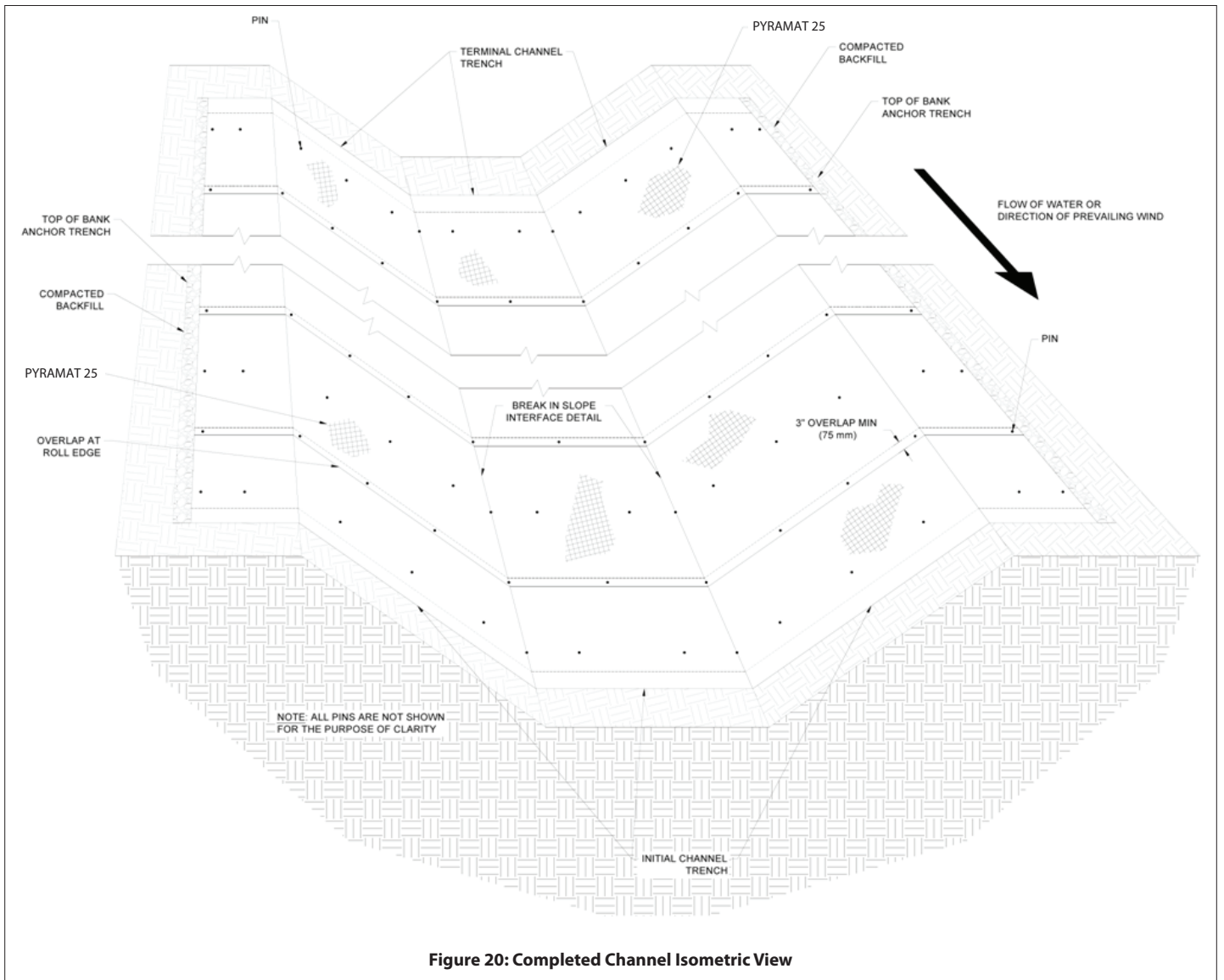

ESTABLISH VEGETATION

Vegetation can be established with Pyramat® 25 by broadcast seeding, hydraulic seed application (hydroseeding), or turf / sodding. Seed application rate, seed type, sod type, and irrigation rate should be selected based on local or site specific knowledge and time of year. For best results, consider having a site specific soil test performed to help determine what soil amendments, such as lime and fertiliser, need to be incorporated into the soil to promote healthy vegetation.

WITH SEED

1. Determine the seed location. Seed can be placed entirely on top of soil filled Pyramat® 25, or alternatively 50% below Pyramat® 25 prior to pinning and anchoring, with the remainder placed on top of soil filled Pyramat® 25. If a rain event occurs prior to vegetation establishment, having 50% of the seed below Pyramat® 25 ensures that some seed remains in place. Seed placed entirely on top of soil filled Pyramat® 25 will allow for faster vegetation establishment.
2. If seeding below Pyramat® 25, ensure 50% of the seed is placed prior to the installation of Pyramat® 25.
3. Once Pyramat® 25 is in place, distribute soil on top by filling the Pyramat® 25 approximately 25 mm thick when measured. Soil filling can be accomplished manually or by using a small piece of equipment. Do not place excessive soil above Pyramat® 25. See Consider Project Specific Needs for guidance on driving equipment across Pyramat® 25.
4. Irrigate as necessary to establish and maintain vegetation until 75% of vegetation has established and has reached a height of 50 mm. Frequent, light irrigation will need to be applied to seeded areas if natural rain events have not occurred within two weeks of seeding. When watering seeded areas, use a fine spray to prevent erosion of seeds or soil. Do not over irrigate. Proper irrigation guidance is provided under the Maintenance portion of this document.

WITH SOD

1. Turf or Sod will be always placed on top of Pyramat® 25 for immediate vegetative growth.
2. Pins should be used to secure the sod against Pyramat® 25. During the placement of the sod/ turf, ensure that Pyramat® 25 is 100% covered by tightly adjoining rolls or squares of sod along edges. Any voids in between sod pieces should be filled with clean loose soil.
3. Irrigate as necessary. Proper irrigation guidance is provided under the Maintenance portion of this document.
4. Monitor to identify areas where browned/dead sod emerges. These areas may need to be addressed to ensure proper sod establishment.



CONSIDER PROJECT SPECIFIC NEEDS

1. A deeper trench and/or hard armouring may be required when channels have severe scour potential at IC and TC trenches.
2. For installing Pyramat® 25 panels around curved sections of a channel, trim panels at an angle so that no more than two layers of Pyramat® 25 overlap at any point in time. Additional pins may be needed to secure panel edges towards the break in slope interface depending upon the radius of the curved channel. Install pins as necessary to securely fasten Pyramat® 25 to the ground.
3. Vehicular traffic should not be allowed on Pyramat® 25 at any time.
4. Disturbed areas should be reseeded. If ruts or depressions develop for any reason, rework soil until smooth and reseed or sod such areas.

SHORT-TERM AND LONG-TERM MAINTENANCE OF PYRAMAT® 25

The purpose of this section is to provide some general guidelines for performing short-term and long-term maintenance of Pyramat® 25 with respect to maintaining vegetation reinforced with Pyramat® 25, and patching of Pyramat® 25 (in the event it needs to be removed or replaced). These procedures are to be considered minimum guidelines for proper maintenance, and further maintenance techniques may be appropriate considering local practices and procedures.

PYRAMAT® 25 PROTECTED CHANNEL

For Pyramat® 25 to be most effective, it is important to ensure that it is properly maintained both during construction and after construction. Identifying trouble areas is easy with Pyramat® 25, and it can make identifying potential threats much simpler and manageable. Look for areas with sparse, dying, or no vegetation as these are obvious signs that Pyramat® 25 is losing intimate contact with the channel surface. If loss of ground surface occurs, Pyramat® 25 will need to be removed and reinstalled as described in Patching and Repairs Section after the eroded area is backfilled with compacted soil that is similar to material of the channel. After Pyramat® 25 is reinstalled, re-establish vegetation on the newly installed Pyramat® 25 and disturbed areas. Monitor the sites to determine if frequent watering may be required to establish vegetation.

To minimise exposure to unwanted maintenance and repair, Pyramat® 25 armoured channels should be free of vehicular traffic. Routine maintenance and channel inspections should be performed by foot traffic only. Tracked equipment such as skid steers, excavators, or dozers should only be allowed to traffic over Pyramat® 25 in times of emergency after vegetation establishment is complete. Failure to control unauthorised traffic can result in Pyramat® 25 being damaged resulting in erosion below Pyramat® 25 during storm events.

MAINTAINING VEGETATION

Good vegetative cover will ensure maximum performance of Pyramat® 25. Vegetative cover care starts before a project is complete and is ongoing until all Pyramat® 25 is installed. Vegetative cover should be given every opportunity to grow and establish well. This will require that a contractor periodically fertilise and water the grasses as needed until a project is complete in the short-term, with the owner of the slope fulfilling the maintenance of the slope in a similar fashion for the long-term. For the entire lifecycle of Pyramat® 25, every effort must be made to prevent unauthorised encroachments, grazing, vehicle traffic, the misuse of chemicals, or burning during inappropriate seasons.



PATCHING AND REPAIRS

Pyramat® 25 may require localised repair at times. For emergency repairs, an adequate supply of Pyramat® 25 should be maintained in inventory with the necessary tools to install. This will allow for a timely, initial repair of the system.

1. In order to identify areas in need of repair, the site should be patrolled immediately after rain events of 50 mm or more. When patrolling look for areas of sparse vegetation, exposed edges of Pyramat® 25, and areas where direct contact between Pyramat® 25 and the channel surface is compromised. Pyramat® 25 should be rated as Acceptable, Minimally Acceptable, or Unacceptable during inspection.
 - A. Acceptable (A) - The rated area is in satisfactory, acceptable condition, and will function as designed and intended during the rain event. Pyramat® 25 has no exposed edges, is installed tightly by maintaining direct contact to the channel surface with no rilling beneath, and has over 90% vegetation cover. There is no noticeable damage present.
 - B. Minimally Acceptable (M) - The rated area has a minor deficiency that needs to be corrected. The minor deficiency will not seriously impair the functioning of the area during the next rain event; however, the overall reliability of the project will be lowered because of the minor deficiency. Pyramat® 25 has 75% vegetation cover with un-vegetated patches as large as one square metre. Edges of Pyramat® 25 are exposed with noticeable damage. Minimal erosion has occurred underneath Pyramat® 25.
 - C. Unacceptable (U) - The rated area is unsatisfactory. The deficiency is so serious that the area will not adequately function in the next rain event. Pyramat® 25 has been physically torn, ripped, or lifted from the channel surface. Less than 75% vegetation cover is present with un-vegetated patches being greater than one square metre, and there is evidence that erosion is occurring beneath Pyramat® 25.
2. Repair any raised or exposed edges of Pyramat® 25 by driving existing and additional pins along the edges as necessary to securely fasten to the ground. Inspect areas where the vegetation is not growing on top of Pyramat® 25. Many times this is an indicator that Pyramat® 25 has lost contact with the ground beneath. Check for voids beneath Pyramat® 25 and fill any holes, gullies, etc. with compacted fill material if possible. Replace Pyramat® 25 as described below.
3. To repair Pyramat® 25, cut out and remove damaged areas in a square configuration a minimum size of 600 mm by 600 mm. Remove all vegetation and debris atop of Pyramat® 25. Loosen the top 25 to 50 mm of soil in the patch area then seed. The subgrade of area to be patched shall be prepared to be smooth and uniform and transition smoothly into the in-situ area. Cut a square Pyramat® 25 patch a minimum of 300 mm greater than the damaged area for all four sides of the patch. Overlap the patch area in all directions a minimum of 300 mm. The patch overlaps shall be tucked under the existing damaged Pyramat® 25 material (Figure 21 and Figure 22).

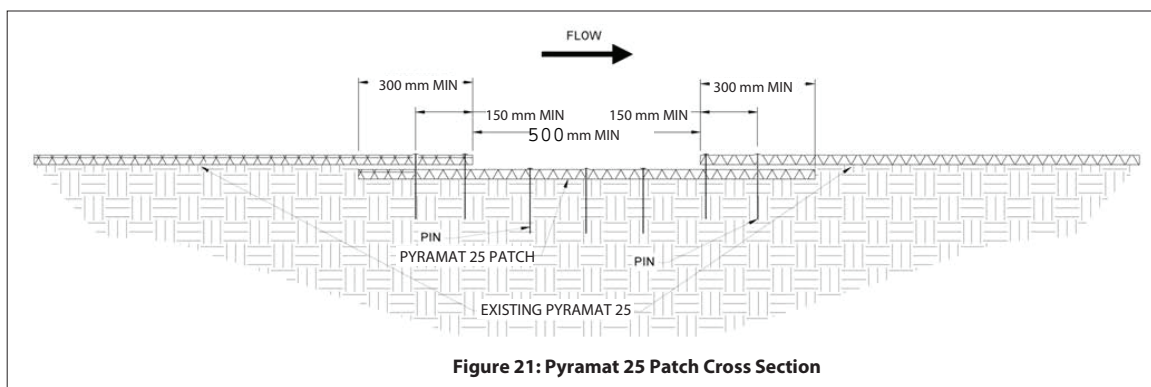
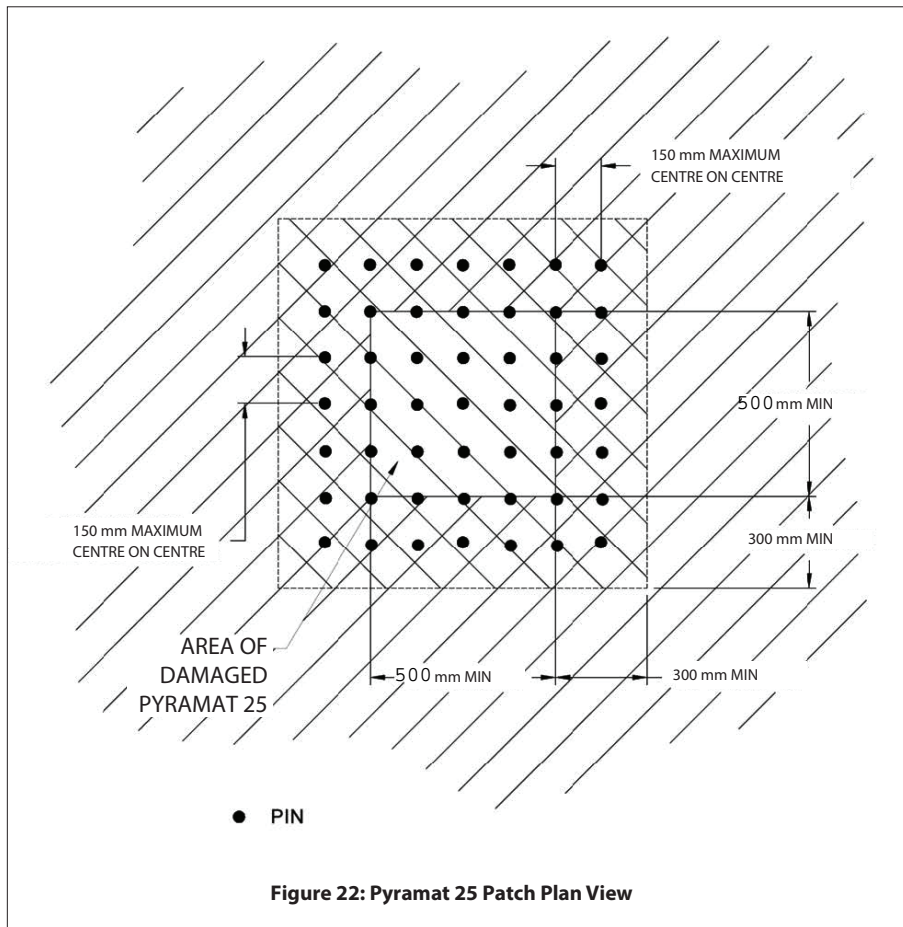

Figure 21: Pyramat 25 Patch Cross Section





4. Install pins at 150 mm (max) centres. For larger areas of damage, anchors should be installed to match existing anchor pattern. Once Pyramat® 25 is in place, vegetate per project specifications.

SUMMARY

Maintenance should consist of watering and weeding, repair of all erosion, and any re-seeding as necessary to establish a uniform stand of vegetation during construction and beyond. A minimum of 70% of the armoured area should be covered with no bare or dead spots greater than one square metre. Throughout the duration of the project, the contractor should water all grassed areas as often as necessary to establish satisfactory growth and to maintain its growth throughout the duration of the project. After the project is complete, it is the responsibility of the owner to maintain and upkeep all Pyramat® 25 installed areas for long term performance and best results as described herein for superior slope armouring.

DISCLAIMER: All information provided in this publication is correct to the best knowledge of the company and is given out in good faith. The information presented herein is intended only as a general guide to the use of such products and no liability is accepted by Global Synthetics Pty Ltd and Global Synthetics QLD Pty Ltd for any loss or damage however arising, which results either directly or indirectly from the use of such information. Global Synthetics Pty Ltd and Global Synthetics QLD Pty Ltd have a policy of continuous development so information and product specifications may change without notice.

JUL 17

