

User Guide

My Important Information

Use this space to write information that you may need to refer to in the future.

Lock Screen Secret Key

Pattern



PIN _____

Password _____

Wi-Fi Information

Network Name _____ Password _____

Google Sign-in Information

Email or phone _____ Password _____

Welcome to the GreatCall Family!

Thank you for choosing the Jitterbug Smart2. Our newly designed smartphone features a 5.5" screen and a menu organized in a single list, making it even easier for you to stay connected with family and friends. Our exclusive health and safety services can be accessed right from your phone so you can stay active, mobile and independent.

This helpful User Guide contains everything you need to know about your Jitterbug Smart. And if you need any more information we have videos, how-to cards and more in our Learning Center at greatcall.com/LearningCenter.

Best Regards,
Your friends at GreatCall

Table of Contents

SECTION 1: GETTING STARTED	1
Key Items in Your Jitterbug Box.....	2
Your Jitterbug Smart2.....	3
Charging the Battery	5
Understanding Touch Gestures.....	6
Phone Overview.....	7
Home Screen Overview.....	8
Making a Call.....	9
Sending a Text Message	10
Voice Typing	12
Taking a Photo	13

Setting Up Your Voicemail Greeting	14
Adding a Contact.....	16
Setting Up Wi-Fi.....	18
Section 2: The Jitterbug Experience.....	20
Jitterbug Home Screen.....	21
Navigation Buttons	22
Title Bar.....	23
App List	24
Status Bar.....	26
Lock Screen.....	28
Checking Talk, Text and Data Usage	33
What is Data?.....	34
Using Wi-Fi to Reduce Your Data Plan Usage.....	35

Connecting to Wi-Fi	36
5Star Service	37
The Learning Center	38
Section 3: Phone Calls	39
Phone App Overview	40
Dial Pad	41
Call History	42
Contacts	43
Voicemail	44
Answering or Ignoring a Call	45
Speakerphone	46
Accessing the Dial Pad During Calls	47
Adjusting the Call Volume	48

Adjusting the Ringer Volume	49
Section 4: Text Messages.....	50
Text Messages App Overview	51
Sending New Text Messages	52
Reading and Replying to Text Messages.....	53
Sending Photo Messages	54
Deleting Text Messages.....	55
Section 5: Camera	56
Camera App Overview.....	57
Taking a Photo	58
Recording a Video	59
Viewing Your Photos and Videos.....	60
Deleting Your Photos and Videos	61

Sharing Your Photos	62
Section 6: Additional Information.....	63
Setting up Your Email Account	64
Composing and Sending Email	66
Reading and Replying to an Email	67
Sending an Email with a Photo or Video	68
Adjusting the Screen Brightness.....	69
Bluetooth.....	70
Airplane Mode	72
Downloading More Apps	73
Uninstalling Apps	75
Changing Your Color Theme.....	76
Changing the Lock Screen Photo	77

Contacting Us	78
Legal	79
Customer Agreement.....	79
Standard Limited Warranty	92
Safety and Use	97
Licenses.....	105
Index.....	108

SECTION 1: GETTING STARTED

Topics

- Key Items in Your Jitterbug Box
- Your Jitterbug Smart2
- Charging the Battery
- Understanding Touch Gestures
- Phone Overview
- Home Screen Overview
- Making a Call
- Sending a Text Message
- Voice Typing
- Taking a Photo
- Setting Up Your Voicemail Greeting
- Adding a Contact
- Setting Up Wi-Fi

Key Items in Your Jitterbug Box



Jitterbug Smart2



USB Cable

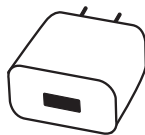

Wall Charger

NOTE:

The rechargeable battery has been pre-installed for your convenience. It is not removable.

Your Jitterbug Smart2

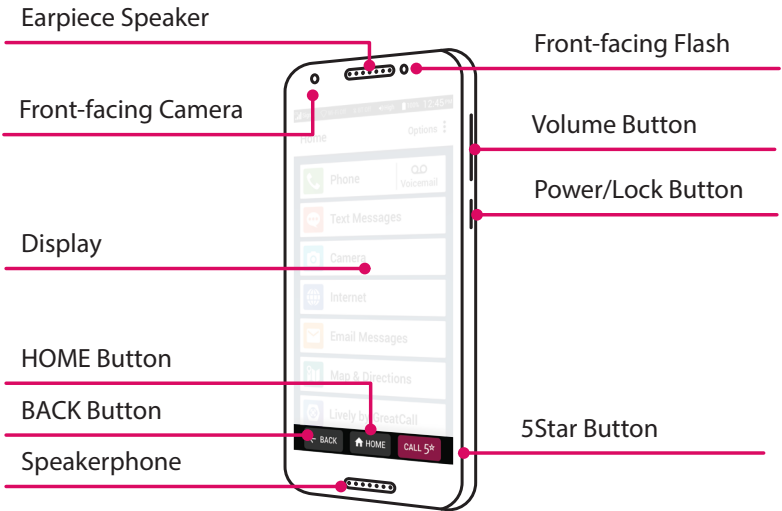

Your Jitterbug Smart2 (continued)

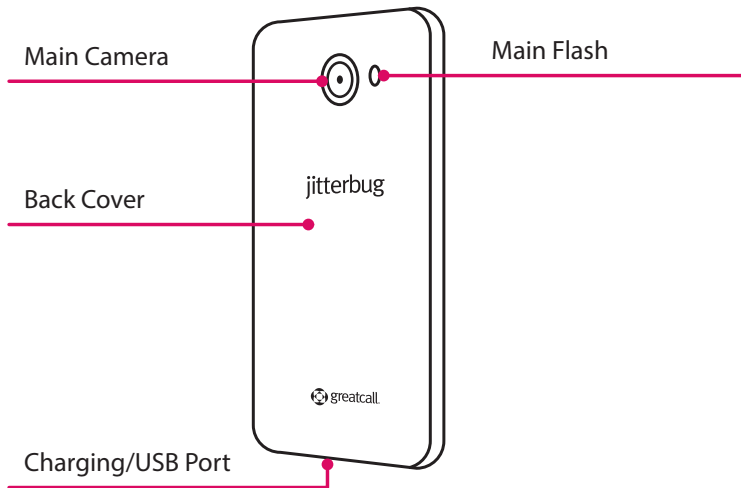

Charging the Battery

- 1) Plug larger end of **USB Cable** into **Wall Charger**.
- 2) Plug **Wall Charger** into a wall outlet.
- 3) Plug smaller end of **USB Cable** into the bottom of your Jitterbug.

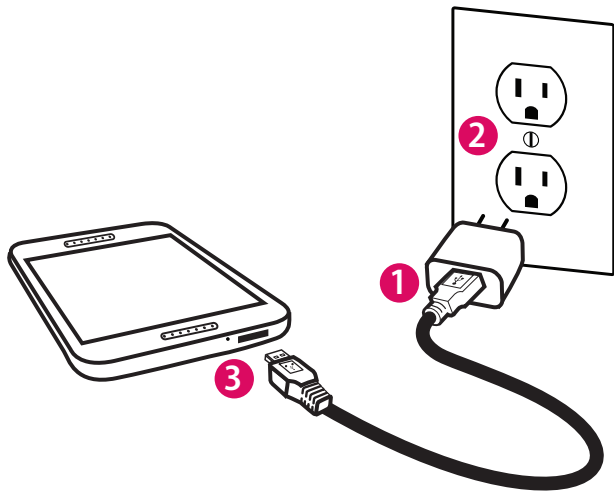

Understanding Touch Gestures

These are the most common touch gestures you will use when interacting with your Jitterbug touch screen:



TAP

Briefly touch the screen with your fingertip



PRESS AND HOLD

Touch the screen for an extended period of time

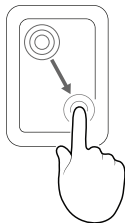

DRAG

Move your fingertip across the screen without losing contact

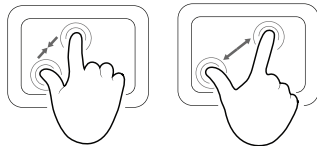

PINCH AND SPREAD

Touch the screen with two fingers and bring them together or apart

Phone Overview

- A) **Volume Button** – PRESS upper end of button to increase volume; PRESS lower end of button to decrease volume.
- B) **Power/Lock Button** – QUICKLY PRESS to lock or wake your phone; PRESS AND HOLD to power your phone on or off.
- C) **BACK Button** – TAP to return to the previous screen.
- D) **HOME Button** – TAP to return to the Home Screen.
- E) **5Star Button** – PRESS AND HOLD to get help in any unsafe or uncertain situation (requires Health & Safety Package).



Home Screen Overview

- A) **Title Bar** – Name of the screen you are viewing.
- B) **Status Bar** – Shows you wireless connectivity, ringer volume, battery and current time information.
- C) **Options** – TAP to view more options relevant to the screen you are currently viewing.
- D) **App List** – A list of the apps you use most.



Making a Call

- 1) On the Home Screen, TAP Phone.
- 2) TAP Dial Pad.
- 3) Enter the 10-digit phone number and TAP CALL.

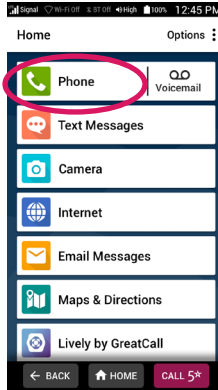

1

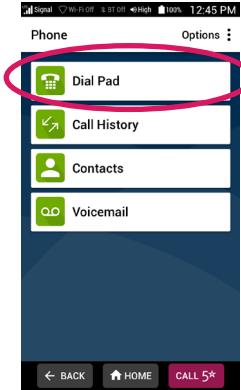

2



3

Sending a Text Message

- 1) On the Home Screen, TAP Text Messages.
- 2) TAP Create New Message.
- 3) TAP Enter Number.

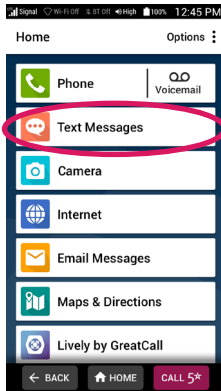

1

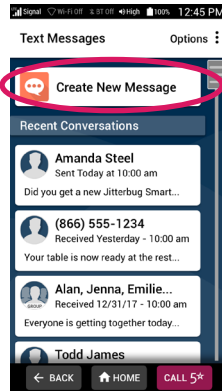

2

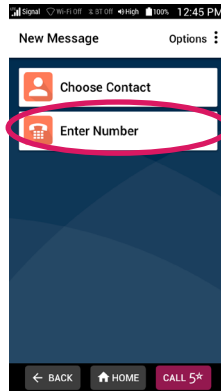

3

Sending a Text Message (continued)

- 4) Enter the 10-digit phone number and TAP **Next**.
- 5) Compose your text message using the keyboard.
- 6) TAP **Send**.

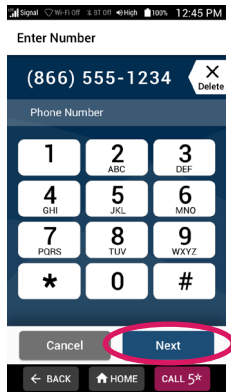

4

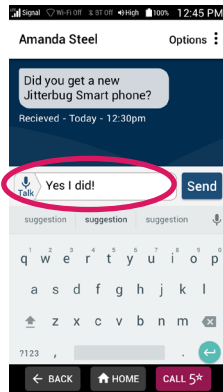

5

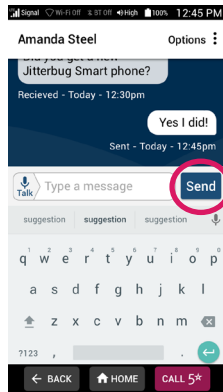

6

Voice Typing

- 1) When using the keyboard, TAP the **Talk** icon.
- 2) Speak your message.
- 3) If needed, edit your message using the keyboard or by using the **Talk** icon again.

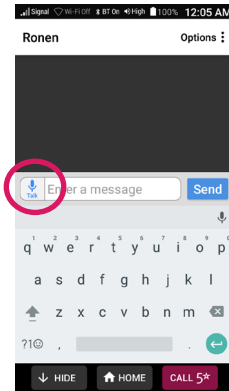

1

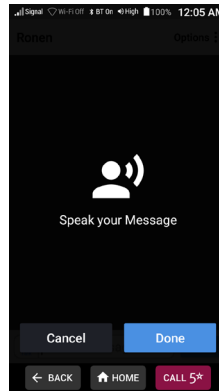

2

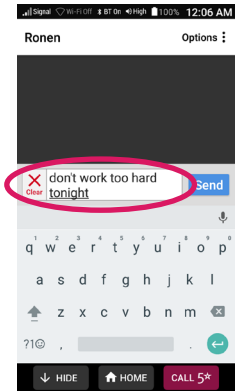

3

Taking a Photo

- 1) On the Home Screen, TAP Camera.
- 2) TAP Camera.
- 3) TAP where you want to focus, then TAP the circle **Shutter** button.

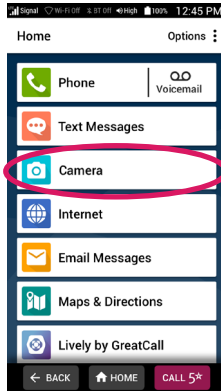

1

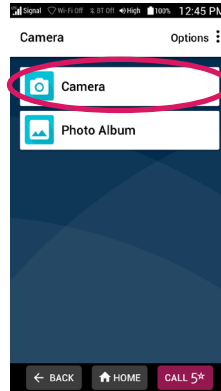

2

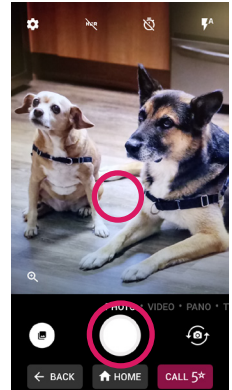

3

Setting Up Your Voicemail Greeting

- 1) On the Home Screen, TAP **Voicemail**.
- 2) TAP **Set Greetings Message**.
- 3) TAP **Record New Greeting** and begin speaking your greeting.

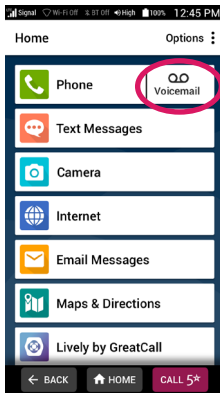

1

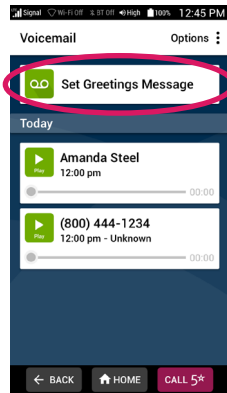

2

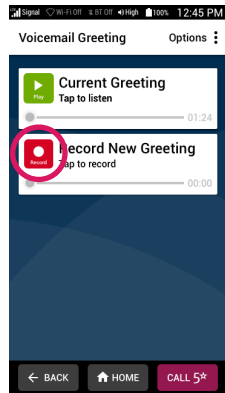

3

Setting Up Your Voicemail Greeting (continued)

- 4) TAP **Stop** to finish your recording.
- 5) TAP **Save Greeting** if you are satisfied or **Discard Recording** if you would like to record a new greeting.

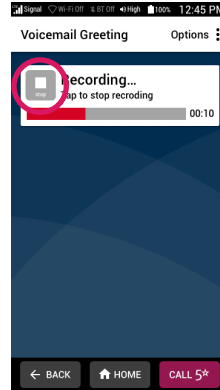

4

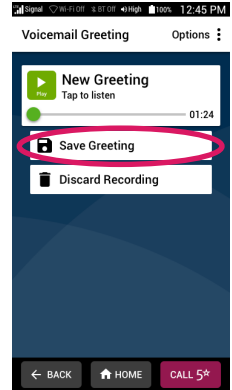

5

Adding a Contact

- 1) On the Home Screen, TAP Phone.
- 2) TAP Contacts.
- 3) TAP Add New Contact.

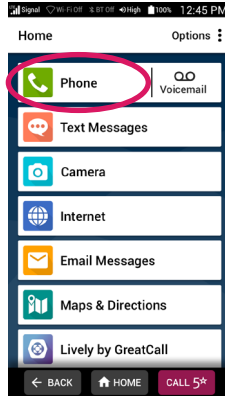

1

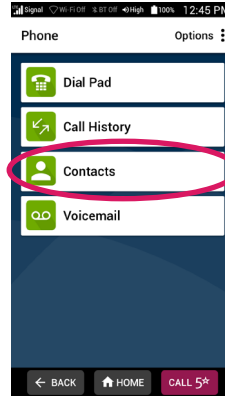

2

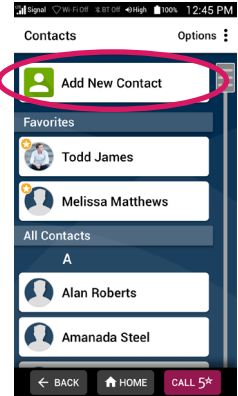

3

Adding a Contact (continued)

- 4) Enter contact name and TAP Next Step.
- 5) Enter contact phone number and TAP Next Step.
- 6) TAP Save Contact.

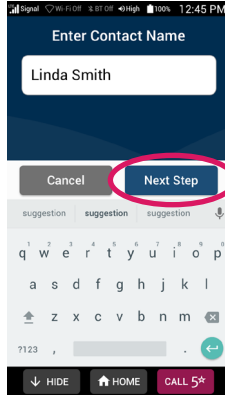

4

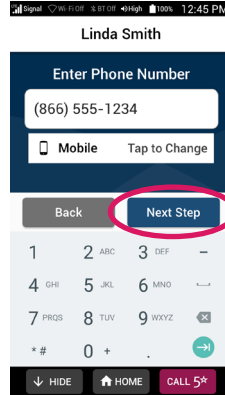

5

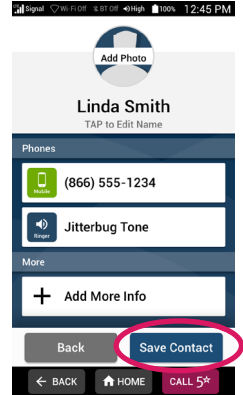

6

Setting Up Wi-Fi

- 1) On the Home Screen, DRAG to scroll down and TAP **Phone Settings**.
- 2) TAP **Internet & Devices**.
- 3) TAP **Wi-Fi**.

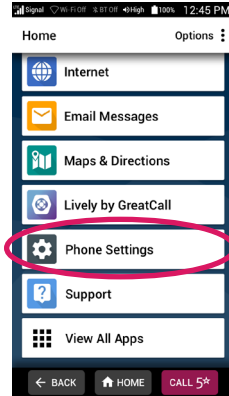

1

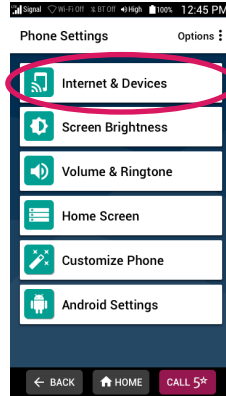

2

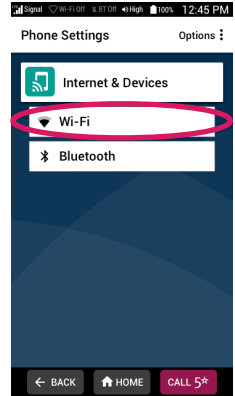

3

Setting Up Wi-Fi (continued)

- 4) TAP the switch to turn on Wi-Fi and then TAP your network name.
- 5) Enter the network password and TAP **CONNECT**.

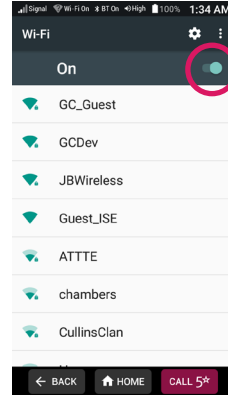

4

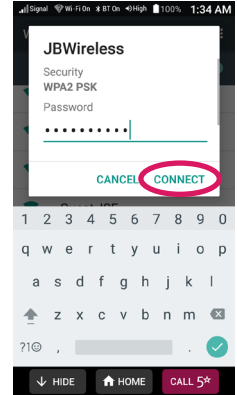

5

Section 2: The Jitterbug Experience

Topics

- Jitterbug Home Screen
- Navigation Buttons
- Title Bar
- App List
- Status Bar
- Lock Screen
- Checking Talk, Text and Data Usage
- What is Data?
- Using Wi-Fi to Reduce Your Plan Usage
- Connecting to Wi-Fi
- 5Star Service
- The Learning Center

Jitterbug Home Screen

The **Home Screen** is the first thing you see every time you unlock your phone. From this screen you can access all features of your Jitterbug. The Home Screen is organized into four sections:

- A) Status Bar** – Shows you important status information.
- B) Title Bar** – Where you are and relevant options.
- C) App List** – A list of the apps you use most.
- D) Navigation Buttons** – Navigate around your phone

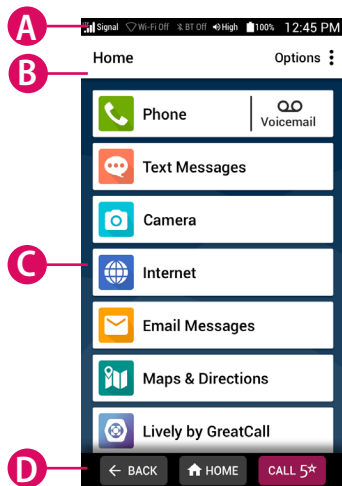

Navigation Buttons

At the bottom of your screen you will find three buttons that are used frequently to navigate around your phone.

- A) **BACK Button** – Takes you one step back from your last action.
- B) **HOME Button** – Takes you back to the Home Screen.
- C) **5Star Button** – PRESS AND HOLD to get help in any unsafe or uncertain situation (requires Health & Safety Package).

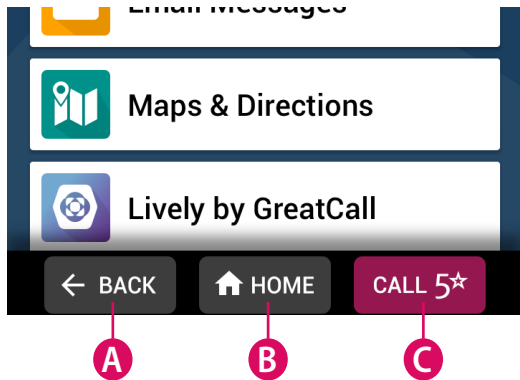

Title Bar

The **Title Bar** will appear at the top of your Home Screen, as well as many of the other apps you will use on your Jitterbug. It contains the following:

- A) **Screen Name** – The name of the screen you are currently viewing. When viewing the Home Screen you will see “Home”.
- B) **Options** – Additional options relevant to the screen you are viewing. You will also find helpful learning tips here.

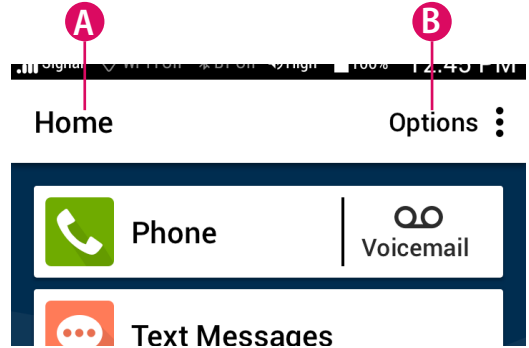

App List

An “app” is a small application designed to do a specific task for you. Your favorite apps will be displayed in the Home Screen. We’ve added some here to get you started, but you can always adjust this list by using the **Options** button in the **Title Bar**.



Phone – Make calls.



Voicemail – Listen to voice messages people have left you.



Text Messages – Send and receive text messages.



Camera – Capture photos or videos.

App List (continued)



Internet – Find websites that interest you.



Email – Send and receive email messages.



Maps & Directions – Get directions to your destination.



Lively – Update your Personal Emergency Profile.



Phone Settings – Adjust important settings of your phone.



Support – Check your plan usage and find helpful tips.



All Apps – Additional apps that you may find useful.

Status Bar



The **Status Bar**, at the top of your screen, shows you important information about the state of your phone.



Cellular Signal Strength – Affects your call quality. The more bars you have the stronger your signal.



Wi-Fi Status – Use a Wi-Fi network to save Data usage on your plan. You can turn this on or off under **Phone Settings**.

Status Bar (continued)



Bluetooth Status – Let's you know if you're connected to a Bluetooth device such as a car stereo or wireless headphones. Turn this feature on or off under **Phone Settings**.



Ringer Volume – Adjust the Ringer Volume using the **Volume Button** on the side of your phone.



Battery Level – Allows you to keep track if you need to charge your phone.

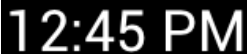

Current Time – The current time automatically set by the GreatCall network.

Lock Screen

Your Jitterbug is equipped with a **Lock Screen** that prevents accidental dialing as well as an extra layer of security if you happen to misplace your phone.

To lock and unlock your phone:

- 1) QUICKLY PRESS the **Power/Lock Button** on the side of your phone.

NOTE:

Your Jitterbug will lock automatically if you haven't interacted with your phone for a few moments.



Lock Screen Overview

- A) 5Star Button** – PRESS AND HOLD to get help in any unsafe or uncertain situation (requires Health & Safety Package).
- B) Current Time**
- C) Current Date**
- D) Your Phone Number**
- E) Swipe to Unlock** – DRAG your finger from the bottom of the screen to the top in one, quick “swiping” motion.

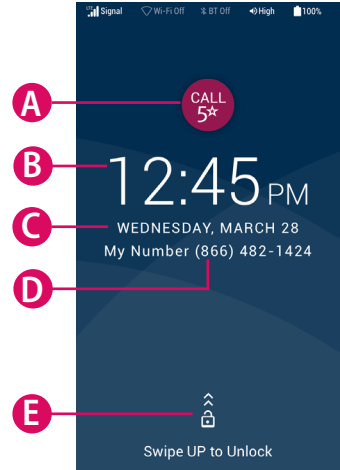

Managing Your Lock Screen Secret Key

You may have setup a lock screen during the initial setup process, but you can always change it later by:

- 1) On the Home Screen, TAP **Phone Settings**.
- 2) TAP **Android Settings**.
- 3) TAP **Lock Screen**.
- 4) TAP **Screen lock**.
- 5) TAP the lock screen option that you desire.

Lock Screen Options

There are five lock screen options you can choose from:

- **None** – No Lock Screen will appear at all. QUICKLY PRESSING the **Power/Lock Button** will take you immediately to the Home Screen.
- **Swipe** – Unlocking your phone will only require you to “swipe” your finger from the bottom of the screen to the top in one, quick motion.
- **Pattern** – After swiping to unlock, you will be required to draw a pattern that only you know.
- **PIN** –After swiping to unlock, you will be required to enter a numerical PIN that only you know.

Lock Screen Options (continued)

- **Password** – After swiping to unlock, you will be required to enter an alphanumeric password that only you know.

**NOTE:**

Do not forget your Lock Screen Secret Key! Use the inside cover of this User Guide to take a note of your Secret Key!

Checking Talk, Text and Data Usage

Your Jitterbug allows you to do much more than just calling your friends and family. It's an easy-to-use smartphone with a broad range of capabilities from sending pictures and videos via Text Message or Email, browsing the Internet to catch up on the latest news, to downloading the latest apps and games.

To avoid overage fees, periodically check your Talk, Text and Data usage by:

- 1) On the Home Screen, TAP the **Support** app.
- 2) TAP **Check my Usage**.

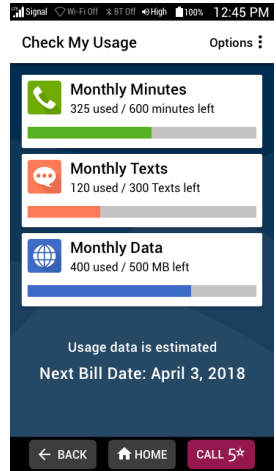

What is Data?

Data is electronic information sent wirelessly between your phone and GreatCall's network. Examples of features that typically use Data on your Data Plan allowance:

- Sharing photos or videos on social media sites like Facebook
- Sending and receiving Email messages
- Browsing the Internet
- Watching streaming videos on a website or using an app like YouTube™
- Listening to music on a website or using an app like Pandora®
- Turn-by-turn directions using the Maps & Directions app
- Downloading apps from the Google Play™ Store

Using Wi-Fi to Reduce Your Data Plan Usage

If your home already has Internet access and a Wi-Fi network, sometimes called a “wireless network”, you can connect your Jitterbug to your Wi-Fi connection to reduce Data usage on your monthly GreatCall Data Plan allowance.

When successfully connected to your Wi-Fi network, all Data usage will go through your home’s Internet access instead of GreatCall’s cellular network.

NOTE:

*Periodically check the **Status Bar** to confirm if you are connected to Wi-Fi. If not, Data use may be deducted from your monthly GreatCall Data allowance. If you are connected to Wi-Fi, you will see this in the **Status Bar**:*



Connecting to Wi-Fi

- 1) On the Home Screen, DRAG to scroll down and TAP **Phone Settings**.
- 2) TAP **Internet & Devices**.
- 3) TAP **Wi-Fi**.
- 4) TAP the switch to turn on Wi-Fi and then TAP your network name.
- 5) Enter the network password and TAP **CONNECT**.

**NOTE:**

Use the inside cover of this User Guide to take note of your Wi-Fi settings for future reference.

5Star Service

The **5Star Button** on your Jitterbug gets you access to GreatCall's unique 5Star Service. This service provides easy-to-use and reliable access to IAED-Certified 5Star Agents who will confirm your location, evaluate your situation, and get you the help you need. Available with all Health & Safety Packages.

PRESS AND HOLD the **5Star Button** to call 5Star in an uncertain or unsafe situation.



NOTE:

If you accidentally call 5Star, please stay on the line and advise the Agent that it is not an emergency. Our Agents are notified of attempted calls, take each one seriously and are trained to call back to confirm your situation.

The Learning Center

At GreatCall, we provide you with easy-to-follow educational tools for the way you want to learn. Whether it's your first smartphone or you are ready for advanced features, our Learning Center is here to help every step of the way.

Go to greatcall.com/LearningCenter to access additional education tools to make you a Jitterbug expert. There you'll find:

- How-to Videos
- How-to Cards
- Frequently Asked Questions
- And more!

Section 3: Phone Calls

Topics

- Phone App Overview
- Dial Pad
- Call History
- Contacts
- Voicemail
- Answering or Ignoring a Call
- Speakerphone
- Accessing the Dial Pad during Calls
- Adjusting the Call Volume
- Adjusting the Ringer Volume

Phone App Overview

TAPPING **Phone** from the Home Screen will give you the following options:

- A) Dial Pad** – Make a call by dialing the number.
- B) Call History** – See your incoming and outgoing call history.
- C) Contacts** – Save phone numbers with a contact name for quicker dialing.
- D) Voicemail** – Listen to any voice messages from callers you may have missed.

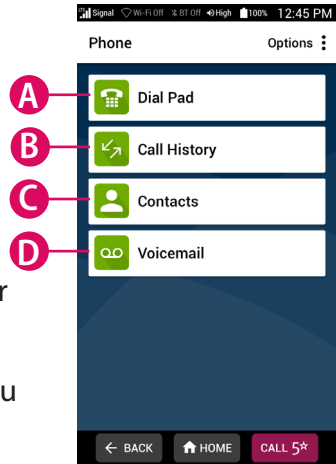

Dial Pad

These are the features of the **Dial Pad**:

- A) Phone Number Field** – This shows the phone number you're about to call as you are dialing. Use the **Delete** button if you make a mistake.
- B) Add Contact** – You have the option of adding this number to a contact name for quicker dialing in the future.
- C) Dial Pad** – This is where you dial the phone number.
- D) CALL Button** – TAP this when you are ready to call.



Call History

From **Call History** you can view your inbound, outbound, missed and dismissed call history. TAP any record for more options like calling back, sending a text message and viewing caller details. These are the types of call history records:



Inbound – Incoming calls that were answered.



Outbound – All outgoing calls.



Dismissed – Incoming calls that you hung up on before answering.



Missed – Incoming calls that ended before you could answer.

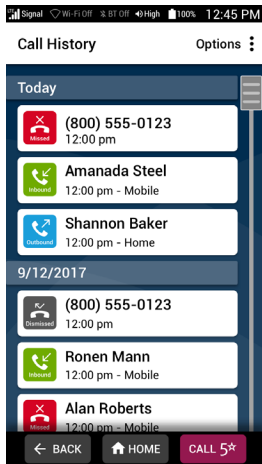

Contacts

Contacts is where you can save your most frequently called contacts so that you don't have to manually dial their number each time. To add a new contact:

- 1) TAP **Add New Contact** at the top.
- 2) Enter their name.
- 3) Enter their phone number.
- 4) TAP **Save Contact**.

Once a contact is saved, you can TAP their name in the **Contacts** list to call them.

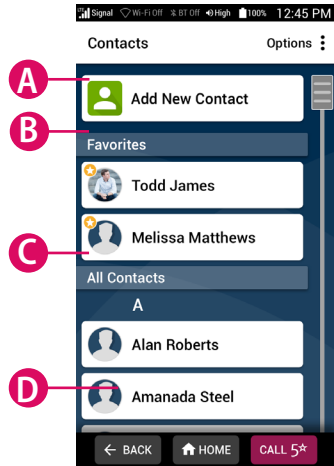

Voicemail

In **Voicemail** you can configure your greeting message that's played to callers when you can't answer the phone. You can also listen to voice messages left for you.

- To update your greeting, TAP **Set Greeting Message**.
- To listen to your voice messages, TAP the **Play** button on any voice message history.

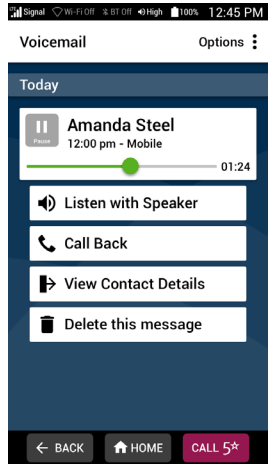

Answering or Ignoring a Call

Your Jitterbug will vibrate and/or ring to notify you when someone is calling. On your screen you will see any information available about the caller as well as an option to answer or to dismiss the call. Dismissing a call will send them to your **Voicemail**.

To answer or dismiss the call:

- 1) PRESS AND HOLD your finger on the **Phone Icon** button and DRAG your finger UP to answer or DOWN to dismiss.



Speakerphone

Once in a call, you will have the ability to route the caller's voice to either the **Earpiece Speaker** or the **Speakerphone**. The Earpiece allows you to have a private conversation if you are in a public setting, while the Speakerphone allows you to free your hands or allow other people surrounding you to participate in the conversation.

To switch between the **Earpiece Speaker** and **Speakerphone**, while on an active call:

- 1) TAP the **Speakerphone On/Off** switch.

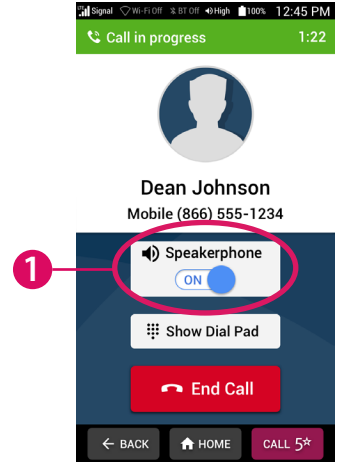

Accessing the Dial Pad During Calls

There are instances while on an a call that you will need to access the **Dial Pad** to dial an extension or to make a selection on an Interactive Voice Response prompt (i.e. “press ‘1’ to speak to a representative”).

To access the **Dial Pad**, while on an active call:

- 1) TAP the **Show Dial Pad** button.
- 2) TAP the **Hide Dial Pad** button to go back to the active call information screen or to access the **Speakerphone** setting.

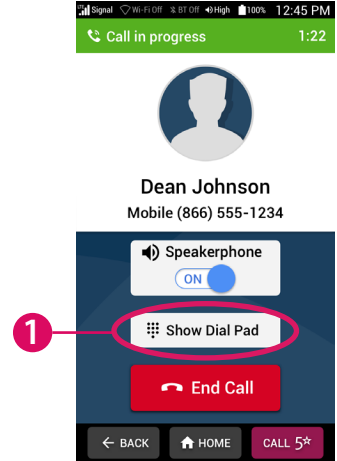

Adjusting the Call Volume

To adjust the **Call Volume**, while on an active call:

- 1) PRESS upper end of the **Volume Button** to increase the Call Volume
- 2) PRESS lower end of the **Volume Button** to decrease the Call Volume.

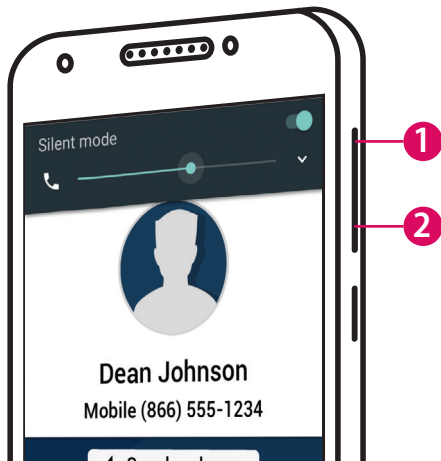

Adjusting the Ringer Volume

To adjust the **Ringer Volume**, while viewing the Home Screen:

- 1) PRESS upper end of the **Volume Button** to increase the Ringer Volume
- 2) PRESS lower end of the **Volume Button** to decrease the Ringer Volume.

**NOTE:**

*As you adjust the **Ringer Volume**, you will see the indicator change in the **Status Bar**.*

Section 4: Text Messages

Topics

- Text Messages App Overview
- Sending New Text Messages
- Reading and Replying to Text Messages
- Sending Photo Messages
- Deleting Text Messages

Text Messages App Overview

Text Messages are a quick and simple way to send short messages to anyone that has a cell phone capable of receiving them.

TAPPING **Text Messages** from the Home Screen will give you the following options:

- A) Create New Message** – Compose a new Text Message.
- B) Conversation History** – A list of Text Message conversations you have had and can reply.

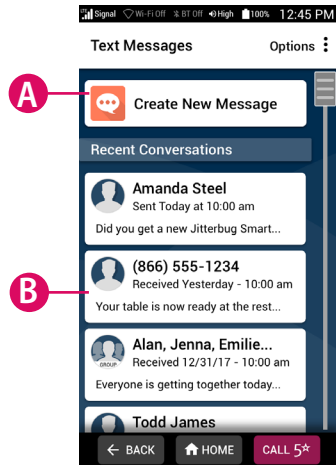

Sending New Text Messages

- 1) TAP **Create New Message**.
- 2) TAP either **Choose Contact** or **Enter Number**.
- 3) Select the recipient from Contacts or enter the phone number.
- 4) Compose your message using the **On-screen Keyboard** or the **Voice Typing** feature (**Talk Button**).
- 5) TAP **Send**.

Reading and Replying to Text Messages

- 1) TAP any **Text Message** in your **Conversation History**.
- 2) DRAG your finger up and down to read the Text Message conversation.
- 3) TAP anywhere in the **“Enter a message”** box to open the **On-screen Keyboard**.
- 4) Compose your message using the **On-screen Keyboard** or the **Voice Typing** feature (**Talk Button**).
- 5) TAP **Send**.

Sending Photo Messages

While composing a new Text Message or replying to an existing Text Message conversation:

- 1) TAP **Options** at the top-right of the screen.
- 2) TAP **Send Photo**.
- 3) TAP the photo you would like to send from your **Photo Album**. A checkbox will appear on the photo when selected.
- 4) TAP **Send**.

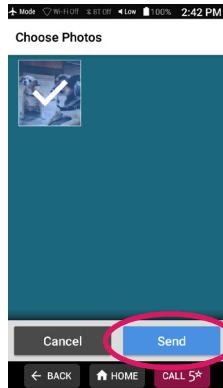
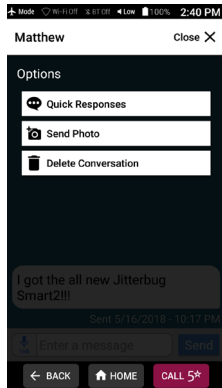

Deleting Text Messages

- 1) TAP any **Text Message** in your **Conversation History**.
- 2) TAP **Options** at the top-right of the screen.
- 3) TAP **Delete Conversation**.
- 4) TAP **Delete Conversation** in the pop-up to confirm.

NOTE:

Text Messages cannot be recovered once deleted.

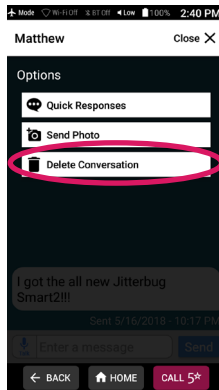
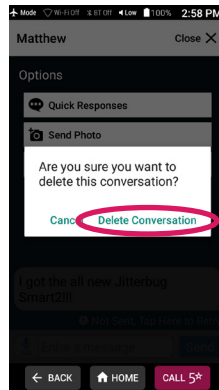
**3****4**

Section 5: Camera

Topics

- Camera App Overview
- Taking a Photo
- Recording a Video
- Viewing Your Photos and Videos
- Deleting Your Photos and Videos
- Sharing Your Photos

Camera App Overview

The **Camera** allows you to take pictures and videos of precious moments and share with friends and family.

TAPPING **Camera** from the Home Screen will give you the following options:

- A) Camera** – Take photos and videos.
- B) Photo Album** – View photos and videos you have captured.

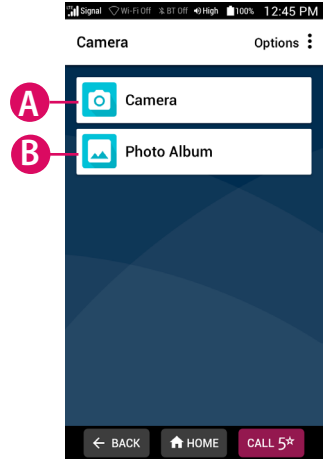

Taking a Photo

- 1) TAP **Camera** to open the **Viewfinder**.
- 2) Aim the back of your phone towards your subject.
- 3) TAP where you would like to focus.
- 4) TAP the circle **Shutter** button.

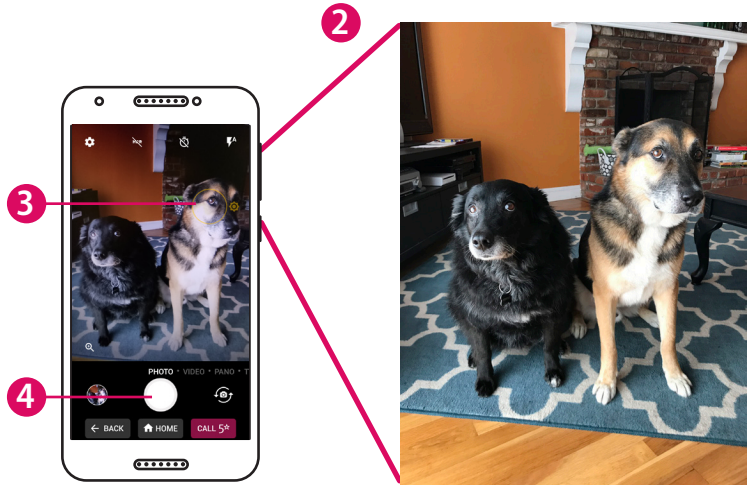

Recording a Video

- 1) TAP **Camera** to open the **Viewfinder**.
- 2) TAP **VIDEO** near the Shutter button. The Shutter button will turn red.
- 3) Aim the back of your phone towards your subject.
- 4) TAP where you would like to focus.
- 5) TAP the circle **Shutter** button to start recording.
- 6) TAP the circle **Shutter** button again to stop recording.

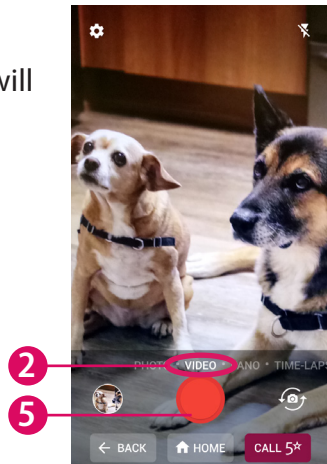

Viewing Your Photos and Videos

After you have captured a photo or video, you can view it by accessing the Photo Album.

- 1) TAP **Photo Album**.
- 2) TAP any photo or video to view it in full screen.

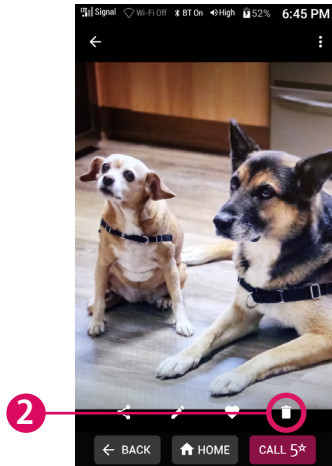

Photo Album

Deleting Your Photos and Videos

While viewing your **Photo Album**, you can delete any photos that you no longer need.

- 1) TAP on a photo in your **Photo Album** to view it.
- 2) TAP the **Trash Can** icon on the bottom-right of the screen.
- 3) TAP **DELETE** in the pop-up to confirm.



Sharing Your Photos

While composing a new **Text Message** or replying to an existing Text Message conversation:

- 1) TAP **Options** at the top-right of the screen.
- 2) TAP **Send Photo**.
- 3) TAP the photo you would like to send from your **Photo Album**. A checkbox will appear on the photo when selected.
- 4) TAP **Send**.

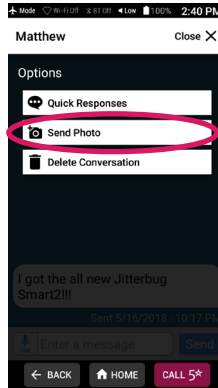

2

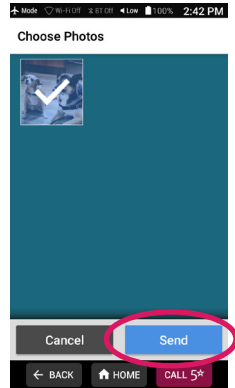

3

Section 6: Additional Information

Topics

- Setting up Your Email Account
- Composing and Sending Email
- Reading and Replying to an Email
- Sending an Email with a Photo or Video
- Adjusting the Screen Brightness
- Bluetooth
- Airplane Mode
- Downloading More Apps
- Changing Your Color Theme
- Changing the Lock Screen Photo
- Contacting Us

Setting up Your Email Account

- 1) On the Home Screen, TAP **Email Messages**.
- 2) Enter your email address, then TAP **NEXT** >.
- 3) Enter your password, then TAP **NEXT** >.

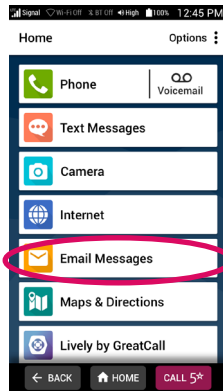

1

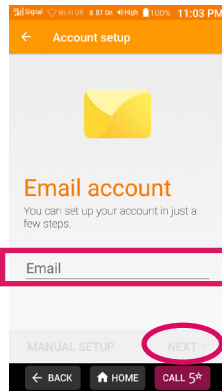

2

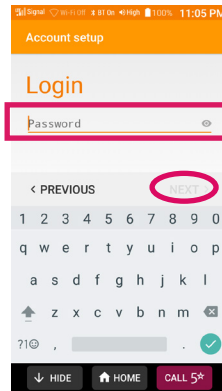

3

Setting up Your Email Account (continued)

- 4) On the "Account options" screen, TAP **NEXT >**.
- 5) Enter an account name (ex. "Personal").
- 6) Enter how you would like your name to appear in outgoing emails.
- 7) TAP **FINISH >**.

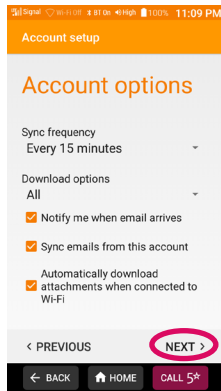

4

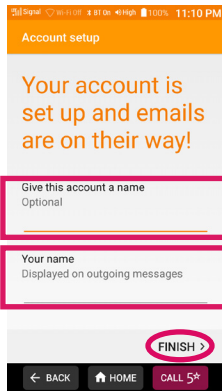

5

Composing and Sending Email

- 1) From your Email Inbox, TAP the + **Button**.
- 2) Enter in the recipient's email address in the "To" field.
- 3) Enter in a **Subject**.
- 4) Compose your email message.
- 5) TAP the **Paper Airplane icon** at the top-right of the screen to send your email.

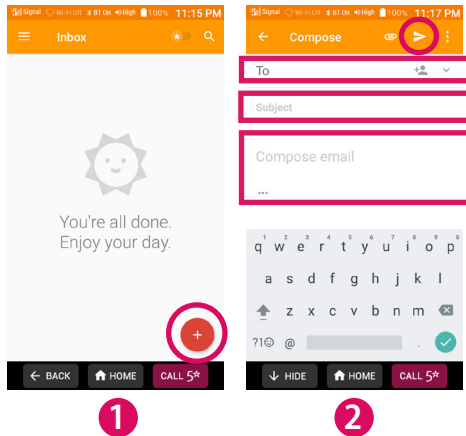

Reading and Replying to an Email

- 1) TAP an email in your Inbox to read it.
- 2) To reply, TAP the **Reply Arrow Button** at the bottom-right of the screen.
- 3) Compose your email message.
- 4) TAP the **Paper Airplane icon** at the top-right of the screen to send your email.

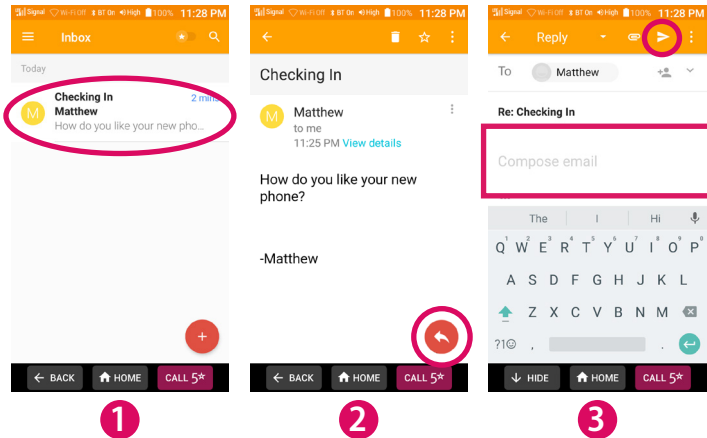

Sending an Email with a Photo or Video

- 1) Start composing an email.
- 2) TAP the **Paper Clip** icon.
- 3) Choose the photos or videos you would like to attach to your email message.
- 4) TAP the **Paper Airplane** icon to send your email message with attachments.

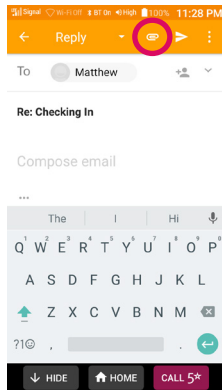

2

Adjusting the Screen Brightness

- 1) On the Home Screen, TAP Phone Settings.
- 2) TAP Screen Brightness.
- 3) TAP the desired brightness setting.

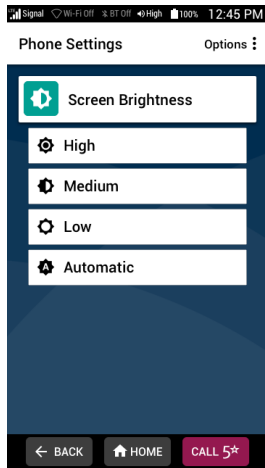

Bluetooth

Bluetooth allows you to connect wirelessly to devices such as car stereos, portable speakers and wireless headphones. To connect to a Bluetooth device:

- 1) On the Home Screen, TAP **Phone Settings**.
- 2) TAP **Internet & Devices**.
- 3) TAP **Bluetooth**.
- 4) TAP the switch to turn on Bluetooth and then TAP your Bluetooth device name.

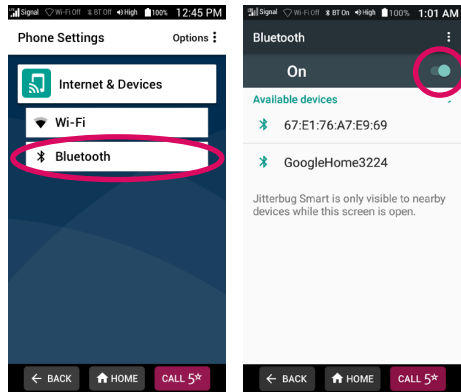

3

4

Bluetooth (continued)

- 5) If prompted, enter the device PIN.

NOTE:

Due to the wide variety of Bluetooth devices available, please refer to the device manufacturer's user documentation for setup tips.

Airplane Mode

When traveling on an airplane, you may be required to put your phone in **Airplane Mode**. In Airplane Mode, all of your Jitterbug's wireless features will be disabled.

To turn on Airplane Mode:

- 1) On the Home Screen, TAP **Phone Settings**.
- 2) TAP **Android Settings**.
- 3) Under "WIRELESS & NETWORKS", TAP **More**.
- 4) TAP the **Airplane Mode switch** to enable this mode. You will notice that the **Cellular Signal Strength** icon will change into an airplane.

Downloading More Apps

In order to download more apps to your phone, you will need a **Google Account**. If you don't have one, you will have an opportunity to create one for free. Once logged into Google, you can download apps from the **Play Store**.

- 1) On the Home Screen, TAP **View All Apps**.
- 2) While viewing All Apps, TAP **Options**.
- 3) TAP **Download New App**.

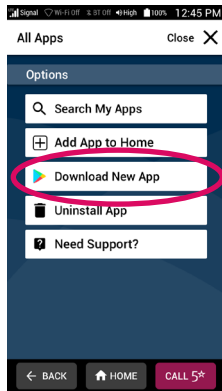

3

Downloading More Apps (continued)

4) TAP SIGN IN.

5) Sign in with your Google Account, or create a new account:

- If you already have a Google Account, enter your account information and follow the prompts.
- If you do not have a Google Account, TAP "Or create a new account" and follow the prompts.

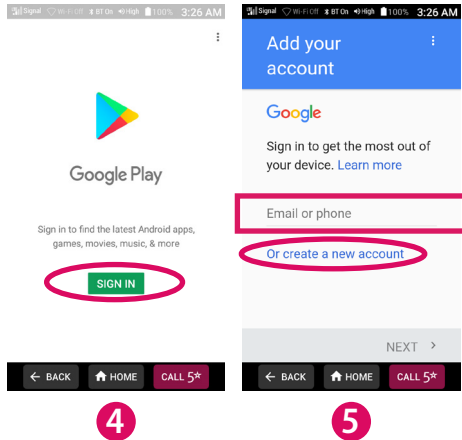

Uninstalling Apps

If you no longer need an app that you installed:

- 1) On the Home Screen, TAP **View All Apps**.
- 2) While viewing All Apps, TAP **Options**.
- 3) TAP **Uninstall App**.
- 4) TAP the app you would like to uninstall.
- 5) TAP **OK** to confirm.

NOTE:

You can only uninstall apps that you have installed. You cannot uninstall the pre-loaded apps.

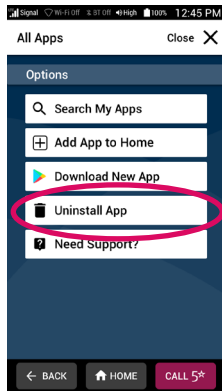

3

Changing Your Color Theme

Personalize your phone by changing the color theme:

- 1) On the Home Screen, TAP **Phone Settings**.
- 2) TAP **Customize Phone**.
- 3) TAP **Set Color Theme**.
- 4) TAP the color that you like.
- 5) TAP **Set Color**.

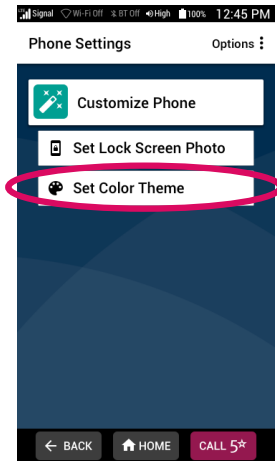

Changing the Lock Screen Photo

Personalize your phone by changing the **Lock Screen** photo:

- 1) On the Home Screen, TAP **Phone Settings**.
- 2) TAP **Customize Phone**.
- 3) TAP **Set Lock Screen Photo**.
- 4) TAP a photo that you like from your **Gallery**.
- 5) PINCH/SPREAD and DRAG your fingers to reposition the photo to fit the screen.
- 6) TAP **SET WALLPAPER** at the top of the screen.

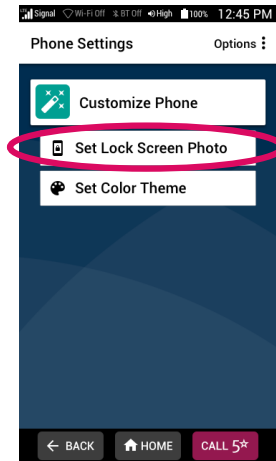

Contacting Us

If you have any questions or comments, we're here to help:

- Send us an email at:
CustomerService@GreatCall.com
- Call us toll-free at:
[1-800-733-6632](tel:1-800-733-6632)
- Write to us at:
GreatCall Customer Service
P.O. Box 4428
Carlsbad, CA 92018

Legal

Customer Agreement

1. Welcome To The GreatCall® Family

Please read this agreement regarding your phone and service. When you accept this agreement, you're bound by its conditions. It applies to all of your services from GreatCall and covers important topics such as:

- How long this agreement lasts
- Your rights to refuse or cancel this agreement
- Our friendly 30-day return policy
- Our rights to limit or end service or this agreement
- Limitations of liability and privacy
- How to handle disputes if they arise, including arbitration

2. Your Monthly Rate Plan

The monthly rate plan you select is part of this agreement. To the extent any condition in your plan expressly conflicts with this agreement, the condition in your plan will apply.

3. Your Rights To Refuse Or Cancel This Agreement

After you've had an opportunity to review this agreement, it will begin when you do any of the following to indicate your

acceptance:

- Activate your service
- Give us a written or electronic signature indicating your acceptance
- Tell us electronically that you accept

If you do not wish to accept this agreement, do not do any of the above actions.

3.1 30-Day Return Policy

If for any reason, within 30 days from date of purchase, you are not completely satisfied with your device, we will refund the activation fee, the first month's service charge, the cost of the device, plus applicable taxes, less the restocking fee, if you:

- have not exceeded any Usage Limitation (defined below); and
- return the phone in "like new" condition, as determined by GreatCall, in the original box with all components and materials

Shipping charges are non-refundable.

The activation fee is non-refundable if you:

- ordered a new phone without paying the activation fee
- exceeded any Usage Limitation (defined below)
- activated two phones and are returning only one phone
- send a device that is not in "like-new" condition, as determined by GreatCall

Usage Limitations:

- Minutes Limitations:
 - Usage Limitation with respect to Minutes means 30 minutes or less of talk time.

- If you have used more than 30 minutes of talk time within 30 days from the date of purchase, but did not exceed your plan minutes, then we will charge you the lesser of:
 - your monthly minute plan service charge; or
 - 35¢ per minutes
- If you have used more than 30 minutes of talk time within 30 days from the date of purchase, and exceeded your plan minutes, then we will retain your monthly service charge plus \$0.35 per minute for each additional minute over your plan minutes.
- Data Limitations:
 - Usage Limitation with respect to Data means 50MB or less of data.
 - If you have used more than 50MB of data within 30 days from the date of purchase, but did not exceed your data plan, then we will charge you your monthly service charge.
 - If you have used more than your data plan within 30 days from the date of purchase, then we will retain your monthly service charge, plus 10 cents per each MB used over your monthly data plan.
- Text Limitations:
 - Usage Limitation with respect to texts means 50 or less texts or picture messages.
 - If you have used more than 50 texts or picture messages within 30 days from the date of purchase, but did not exceed your text plan, then we will charge you the lesser of:
 - your monthly text plan service charge; or
 - 10¢ per text or picture message

Return Information:

- Please contact our Customer Service Department at 1-800-733-6632, available between 5 am - 9 pm PST, seven days a week, to cancel your account and obtain a return authorization number. If your phone was purchased from a retail store, it must be returned to that store and is subject to the store's return policy.
- Approved returns must be shipped back at the customer's expense in the original packaging.
- Refunds, if applicable, will be processed back to the party that paid in the same manner that payment was received. Please allow 21 business days for processing. You will be charged a \$10 restocking fee.

3.2 Service Cancellation

If for any reason you are not completely satisfied with your service and you wish to cancel, you'll be able to do so as described below. However, if you have purchased any Add-On Minutes, they are not refundable and these minutes will expire after your last bill. You will receive a final bill that will detail all the charges and credits on your account.

If you wish to cancel your service before the end of a given month, you'll be responsible for any account charges and overages through the date of your final bill. If you have purchased any Add-On Minutes, they are not refundable and these minutes will expire after your final bill. Although cancellations are effective immediately, we don't bill for partial months; therefore, you'll be charged for the entire month. To cancel your service, please contact our Customer Service Department at 1-800-733-6632 between 5 am - 9 pm PST, seven days a week.

4. Charges And Fees

There is a fee associated with beginning your service and there may be a fee associated with reactivating your service. Usage charges vary depending on where, when and how you call, including toll-free and Operator-assisted calls. Additional features and services, such as Operator assistance, may have extra charges.

4.1 Roaming And Long Distance Charges

There are no long distance or roaming charges for any calls made within the domestic U.S. There may be additional charges for international calls and texts.

4.2 International Rates

When calling from the domestic U.S. to other countries, or when calling from outside of the domestic U.S., additional international calling rates will apply.

4.3 Taxes, Fees And Assessments

We are required by law to charge you certain taxes, surcharges and assessments that will be included on your bill. You are responsible for paying all taxes, surcharges and assessments associated with your GreatCall products and services. These may change from time to time, and we may not be able to give you advance notice about how these changes may affect you. Except as prohibited by law, we may also, at our discretion, require you to pay regulatory and administrative fees to recover our costs of complying with regulatory mandates and Universal Service fees or similarly imposed charges. Any customer who is eligible for an exemption from any tax or fee must provide us with a verifiable, valid and properly executed tax-exempt certificate. Any tax exemption applies only after the date we receive the certificate from you and have verified your eligibility for the exemption.

4.4 How We Calculate Your Bill

Your bill is our notice to you of your fees, charges and other important information. It reflects the fees and charges in effect for your service plan at the time they are incurred. We charge for usage after calls are made or received and charge access and other fees in advance. The length of a call will be rounded up to the next full minute. Charges start when you're connected to an outgoing or incoming call and end after you hang up your phone, the other party on your call hangs up, or the call ends through disconnection. We only bill for calls that connect, including calls answered by machines. Standard usage charges apply to toll-

free calls. There may be additional usage charges for credit card or third party Operator-assisted calls, which may be required in certain areas. You will incur usage charges at a minimum rate of \$0.35 per minute if you exceed your service plan minutes. Billing for usage and related charges may sometimes be delayed. Delayed usage charges may be applied in the month they appear on your bill against minutes included in your service plan for that month, rather than against the included minutes for the month when you actually made or received the call. This may result in charges higher than you'd expect in the later month.

4.5 Payments, Deposits, Credit Cards, And Checks

Payment is due in full as stated on your bill. IF WE DON'T RECEIVE PAYMENT IN FULL WHEN DUE, WE MAY, TO THE EXTENT PERMITTED BY THE LAW OF THE STATE OF THE BILLING ADDRESS WE HAVE ON FILE FOR YOU AT THE TIME, CHARGE YOU A LATE FEE UP TO 1.5 PERCENT A MONTH (18 PERCENT ANNUALLY) OR A FLAT \$5 A MONTH, WHICHEVER IS GREATER, ON UNPAID BALANCES. WE MAY ALSO CHARGE YOU FOR ANY COLLECTION AGENCY FEES BILLED TO US FOR TRYING TO COLLECT FROM YOU. SHOULD WE NOT RECEIVE YOUR LATE PAYMENT, WE MAY SUSPEND YOUR SERVICE UNTIL PAID IN FULL. WE RESERVE THE RIGHT TO CHARGE A REASONABLE RECONNECTION FEE. IF YOUR ACCOUNT REMAINS UNPAID, WE WILL CANCEL SERVICE FOR NON-PAYMENT. We reserve the right to require recurring credit card billing for certain products or services. We also reserve the right to require an advance deposit (or an increased deposit) from you based on your payment history and changes in your plan and/or the frequency of use of our services. We'll pay simple interest on any deposit at the rate the law requires. Please retain your evidence of deposit. You agree that we can apply deposits, payments, or repayments in any order to any amounts you owe us on your account(s). You can't use a deposit to pay any bill unless we agree. We will not honor limiting notations you make on or with your checks. We may charge you up to \$25 for any returned check or denied credit card charges, depending on applicable law.

5. Service Subject To Change

Your service is dependent upon our business requirements, including policies, practices and procedures, which we can change without notice. Unless otherwise prohibited by law, we can also change prices and any other conditions in this agreement at any

time by sending you written notice prior to the billing period in which the changes would go into effect. If you choose to use your service after that point, you're accepting the changes. If the changes have a material adverse effect on you, however, you can end the affected service, without any early cancellation fee, just by calling us within 60 days after we send notice of the change.

6. Rights In Numbers And Electronic Addresses We Assign To You

You do not have any rights in the personal identification number, email address or identifier we assign to you. The same is true for your wireless phone numbers, except for your right to transfer it. In the event we need to change or reassign them, we'll let you know. Please know that your wireless phone number and/or name may appear when you call someone. We rely on this feature to provide services you enjoy.

7. Transferring Or "Porting" Phone Numbers

You may be able to transfer or "port" your phone number from us to another carrier or service provider. We cannot guarantee that this transfer will be successful. If you request that another service provider transfer or "port" your phone number, we will treat this request in the same manner as a request to cancel your GreatCall service. When the transfer is complete you will be responsible for all the terms of cancellation described in Section 3 of this agreement. We may not be able to provide you with some services, such as 9-1-1 location services, while we implement the transfer.

8. Availability Of Service

Wireless phones use radio transmissions to access service. Therefore, we can't provide service when your wireless phone is out of range of our provider's transmission site or if sufficient network capacity is not available. You may not receive service in certain places, particularly in remote areas, with no service at all. Weather, topography, buildings, your wireless phone and other conditions that are outside of our control may also cause dropped calls or other problems with your service.

9. Suspending Service If Your Phone Is Lost Or Stolen

Please notify us immediately if someone steals your phone or you lose it. We'll be happy to provide a courtesy suspension of service for 30 days or until you choose to replace or recover your phone – whichever comes first – if you haven't received a courtesy of this kind within the prior year. Until we provide a courtesy suspension, you'll be responsible for all fees and charges, including those related to the use of services, even if used by another party. We may require a sworn statement about the loss or theft.

10. Lively App License

The Lively App software (if included on your device) is licensed, not sold, to you by GreatCall, Inc. and it is for use only under the terms of this agreement. The Lively App is intended for your personal, non-commercial use and may not be rented, leased, sold, or redistributed by you. GreatCall retains ownership of the Lively App software and reserve all rights not expressly granted to you. In its sole discretion, GreatCall may make available app updates and the terms of this License shall govern such updates unless such update is accompanied by a separate license, in which case the terms of that license will govern.

Subject to the terms herein, you are granted a limited non-exclusive license to use the Lively App software on a single device. You may not, and you agree not to enable others to, reverse engineer, disassemble, attempt to derive the source code of, create derivative works of, or modify the Lively App software or any services provided by the Lively App software.

You acknowledge and agree that certain Lively App features transmit data through your Bluetooth-paired and connected smartphone and could impact charges to your wireless data plan. You agree that all such charges are your responsibility. You can view and control data use of apps, including the Lively App, in your smartphone settings.

11. 5Star

Your device comes equipped with GreatCall's 5Star emergency response service. If you purchase a GreatCall Health & Safety package that includes 5Star Service, your use of 5Star and the Health & Safety Services is subject to the 5Star and Additional

Health & Safety Services Terms and Conditions available at <https://www.greatcall.com/legal/5Star-terms-conditions>.

12. Our Rights To Limit/End Service Or This Agreement

You agree not to resell our service to someone else without prior written permission from GreatCall. You also agree that your wireless phone won't be used for any purpose that is illegal, isn't allowed by this agreement or by your User Guide. WE CAN, WITHOUT NOTICE, LIMIT, SUSPEND OR END YOUR SERVICE OR ANY AGREEMENT WITH YOU FOR VIOLATING THIS AGREEMENT OR FOR ANY OTHER GOOD CAUSE, INCLUDING, BUT NOT LIMITED TO:

- a. Two or more late payments in a 12-month period.
- b. Incurring charges greater than your required deposit or billing limit (even if we haven't yet billed the charges) if you are unwilling to increase your deposit with us.
- c. Incurring charges materially in excess of your monthly access charge (even if we haven't yet billed the charges).
- d. Harassing our employees or agents.
- e. Lying to us.
- f. Interfering with our operations.
- g. Becoming insolvent or going bankrupt.
- h. Breaching this agreement.
- i. "Spamming," or other abusive messaging or calling.
- j. Modifying your phone from the manufacturer's specifications.
- k. Providing credit information we can't verify.
- l. Using your service in a way that adversely affects other customers.

m. Allowing anyone to tamper with your GreatCall number.

We can also temporarily limit your service for any operational or governmental reason.

13. Your Privacy

You agree to the terms of our Privacy Policy, available on our website at www.GreatCall.com/privacypolicy, when you use our services. It may change from time to time, so please review this policy with regularity and care. Among other things, the policy outlines the information we collect about you, how we use that information and with whom we share that information. For example, it may be used to provide certain services, to protect our rights and interests, to respond to legal process or to facilitate a merger. We may also monitor or record your calls with GreatCall representatives to ensure the quality of our services and for other lawful purposes. If you don't agree with the terms of our Privacy Policy, do not purchase a GreatCall phone or use GreatCall services.

14. Disclaimer Of Warranties

WE MAKE NO REPRESENTATIONS OR WARRANTIES, EXPRESS OR IMPLIED, INCLUDING, TO THE EXTENT PERMITTED BY APPLICABLE LAW, ANY IMPLIED WARRANTY OF MERCHANTABILITY OR FITNESS FOR A PARTICULAR PURPOSE CONCERNING YOUR SERVICE OR YOUR PHONE. WE CAN'T PROMISE UNINTERRUPTED OR ERROR-FREE SERVICE AND DON'T AUTHORIZE ANYONE TO MAKE ANY WARRANTIES ON OUR BEHALF. THIS DOESN'T DEPRIVE YOU OF ANY WARRANTY RIGHTS YOU MAY HAVE AGAINST ANYONE ELSE.

15. Indemnification

You agree to indemnify, defend and hold GreatCall harmless from any claims arising out of use of the phone or service, breach of this agreement or violation of any laws or regulations or the rights of any third party by you or any person on your account or that you allow to use your phone or service.

16. Waivers And Limitations Of Liability

UNLESS THE LAW FORBIDS IT IN ANY PARTICULAR CASE, WE EACH AGREE TO LIMIT CLAIMS FOR DAMAGES OR OTHER MONETARY RELIEF AGAINST EACH OTHER TO DIRECT DAMAGES. THIS LIMITATION AND WAIVER WILL APPLY REGARDLESS OF THE THEORY OF LIABILITY, WHETHER FRAUD, MISREPRESENTATION, BREACH OF CONTRACT, PERSONAL INJURY, PRODUCTS LIABILITY, OR ANY OTHER THEORY. THIS MEANS THAT NEITHER OF US WILL SEEK ANY INDIRECT, SPECIAL, CONSEQUENTIAL, TREBLE, OR PUNITIVE DAMAGES FROM THE OTHER. THIS LIMITATION AND WAIVER ALSO APPLIES TO ANY CLAIMS YOU MAY BRING AGAINST ONE OF OUR SUPPLIERS, TO THE EXTENT THAT WE WOULD BE REQUIRED TO INDEMNIFY THE SUPPLIER FOR SUCH CLAIM. You agree we aren't liable for problems caused by you or a third party; by buildings, hills, network congestion, tunnels, weather, or other things we don't control. You also agree GreatCall is not liable for missed VoiceMail(s), or deletions of VoiceMail(s) from your VoiceMail box (if you have one), even if you've saved them.

17. Handling Disputes With GreatCall

ANY CLAIM OR DISPUTE BETWEEN YOU AND GREATCALL IN ANY WAY RELATED TO OR CONCERNING THE AGREEMENT, OR THE PROVISION OF SERVICES OR PRODUCTS TO YOU, INCLUDING ANY BILLING DISPUTES (CLAIM), SHALL BE SUBMITTED TO FINAL, BINDING ARBITRATION BEFORE THE AMERICAN ARBITRATION ASSOCIATION ("AAA"). THIS AGREEMENT TO ARBITRATE ALSO REQUIRES YOU TO ARBITRATE CLAIMS AGAINST OTHER PARTIES RELATING TO SERVICES OR PRODUCTS PROVIDED OR BILLED TO YOU, INCLUDING SUPPLIERS OF SERVICES AND PRODUCTS AND OUR RETAIL DEALERS, IF YOU ALSO ASSERT CLAIMS AGAINST US IN THE SAME PROCEEDING. YOU AND WE ACKNOWLEDGE THAT THE AGREEMENT AFFECTS INTERSTATE COMMERCE AND THAT THE FEDERAL ARBITRATION ACT AND FEDERAL ARBITRATION LAW APPLY TO ARBITRATIONS UNDER THE AGREEMENT. BEFORE INSTITUTING ARBITRATION, YOU AGREE TO PROVIDE US WITH AN OPPORTUNITY TO RESOLVE YOUR CLAIM BY SENDING A WRITTEN DESCRIPTION OF YOUR CLAIM TO US AT: GREATCALL, P.O. BOX 4428, CARLSBAD, CA 92018, AND NEGOTIATING WITH US IN GOOD FAITH REGARDING YOUR CLAIM. IF WE ARE NOT ABLE TO RESOLVE YOUR CLAIM WITHIN 30 DAYS OF RECEIPT OF YOUR NOTICE,

THEN YOU OR WE, INSTEAD OF SUING IN COURT, MAY INITIATE ARBITRATION PROCEEDINGS WITH THE AAA. ARBITRATION WILL BE CONDUCTED UNDER THE AAA'S PUBLISHED WIRELESS INDUSTRY ARBITRATION RULES AND SUPPLEMENTAL PROCEDURES FOR CONSUMER-RELATED DISPUTES, WHICH ARE AVAILABLE BY CALLING THE AAA AT 800-778-7879 OR VISITING ITS WEB SITE AT WWW.ADR.ORG. THE AAA HAS A FEE SCHEDULE FOR ARBITRATIONS. YOU WILL PAY YOUR SHARE OF THE ARBITRATOR'S FEES AND ADMINISTRATIVE EXPENSES ("FEES AND EXPENSES") EXCEPT THAT:

(A) FOR CLAIMS LESS THAN \$25, WE WILL PAY ALL FEES AND EXPENSES; AND

(B) FOR CLAIMS BETWEEN \$25 AND \$1,000, YOU WILL PAY ONLY \$25 IN FEES AND EXPENSES, OR ANY LESSER AMOUNT AS PROVIDED UNDER AAA'S SUPPLEMENTAL PROCEDURES FOR CONSUMER-RELATED DISPUTES. YOU AND WE AGREE TO PAY OUR OWN OTHER FEES, COSTS, AND EXPENSES, INCLUDING THOSE FOR ANY ATTORNEYS, EXPERTS, AND WITNESSES. AN ARBITRATOR MAY ONLY AWARD AS MUCH AND THE TYPE OF RELIEF AS A COURT WITH JURISDICTION IN THE PLACE OF ARBITRATION THAT IS CONSISTENT WITH LAW AND THIS AGREEMENT. AN ARBITRATOR MAY ISSUE INJUNCTIVE OR DECLARATORY RELIEF BUT ONLY APPLYING TO YOU AND US AND NOT TO ANY OTHER CUSTOMER OR THIRD PARTY.

AS A LIMITED EXCEPTION TO THE AGREEMENT TO ARBITRATE, YOU AND WE AGREE THAT:

(A) YOU MAY MAKE CLAIMS TO SMALL CLAIMS COURT, IF YOUR CLAIMS QUALIFY FOR HEARING BY SUCH COURT; AND

(B) IF YOU FAIL TO TIMELY PAY AMOUNTS DUE, WE MAY ASSIGN YOUR ACCOUNT FOR COLLECTION, AND THE COLLECTION AGENCY MAY PURSUE IN COURT CLAIMS LIMITED STRICTLY TO THE COLLECTION OF THE PAST DUE DEBT AND ANY INTEREST OR COST OF COLLECTION AGREEMENT. AS PERMITTED BY LAW, OR WHETHER CLASS ACTION IN COURT, WAIVER SMALL CLAIMS COURT, OR ARBITRATION, YOU AND WE MAY ONLY BRING CLAIMS AGAINST EACH OTHER IN AN INDIVIDUAL CAPACITY AND NOT AS A CLASS REPRESENTATIVE OR A CLASS MEMBER IN A CLASS OR REPRESENTATIVE ACTION. IF A COURT OR ARBITRATOR DETERMINES IN A CLAIM BETWEEN YOU AND US THAT YOUR WAIVER OF ANY ABILITY TO PARTICIPATE IN CLASS OR REPRESENTATIVE ACTIONS IS UNENFORCEABLE UNDER APPLICABLE LAW, THE ARBITRATION AGREEMENT WILL NOT APPLY, AND

YOU AND WE AGREE THAT SUCH CLAIMS WILL BE RESOLVED BY A COURT OF APPROPRIATE JURISDICTION, OTHER THAN A SMALL CLAIMS COURT. JURY TRIAL WAIVER, WHETHER ANY CLAIM IS IN ARBITRATION OR IN COURT, YOU AND WE WAIVE ANY RIGHT TO JURY TRIAL INVOLVING ANY CLAIMS OR DISPUTES BETWEEN YOU AND US.

18. About You

You represent that you're at least 18 years old and have the legal capacity to accept this agreement. If you are ordering for a friend or a member of your family, you are bound by the terms of this agreement, unless and until, your friend or family member has agreed to the terms of this agreement. If you're ordering for a company, you're representing that you are authorized to bind the company to the terms of this agreement, where the context "you" means the company.

19. About This Agreement

If either of us waives or doesn't enforce a requirement under this agreement in an instance, we don't waive our right to later enforce that requirement. You can't assign this agreement or any of your rights or duties under it. We may assign all or part of this agreement or your debts to us without notice, and you agree to make all subsequent payments as instructed. Notices are considered delivered when we send them by email or fax to any email or fax number you've provided to us, or three days after mailing to the most current billing address we have on file for you, if by us, or to the Customer Service address on your most recent bill. If any part of this agreement, including any part of its arbitration provisions, is held invalid, that part may be severed from this agreement. This agreement and the documents to which it refers form the entire agreement between us on their subjects. You can't rely on any other documents or statements on those subjects by any sales or service representatives, and you have no other rights with respect to service or this agreement, except as specifically provided by law. This agreement isn't for the benefit of any third party except our parents, affiliates, subsidiaries, agents and predecessors/successors in interest. Except to the extent we've agreed otherwise in the provisions on late fees and arbitration, this agreement and disputes covered by it are governed by the laws of the state of California, without regard to the conflicts of the laws or rules of that state.

20. Additional Terms For Text Messaging

The message rates that we charge depend on the GreatCall service plan that you selected. You will incur message charges when you send or receive a message, whether the message has been read or unread, viewed or unviewed, solicited or unsolicited. GreatCall does not guarantee that messages will be received. We are not responsible for lost or misdirected messages.

Last updated: 5/10/2018

Standard Limited Warranty

What is covered and for how long?

The warranty period commences upon the date of purchase by the first consumer purchaser of the Product and continuing for the following specified period of time after that date:

Device	1 Year
OEM Rechargeable Battery(ies)*	1 Year
Other Accessories*	1 Year

*If applicable and specifically does not apply to Lively Wearable.

What is not covered?

This Limited Warranty is conditioned upon proper use of the Product. This Limited Warranty does not cover: (a) defects or damage resulting from accident, misuse, abnormal use, abnormal conditions, improper storage, exposure to liquid, moisture, dampness, sand or dirt, neglect, or unusual physical, electrical or electromechanical stress; (b) scratches, dents and cosmetic damage, unless caused by GreatCall; (c) defects or damage resulting from excessive force or use of a metallic object when pressing on a touch screen; (d) equipment that has the serial number or the enhancement data code removed, defaced, damaged, altered or

made illegible; (e) ordinary wear and tear; (f) defects or damage resulting from the use of Product in conjunction or connection with accessories, products, or ancillary/peripheral equipment not furnished or approved by GreatCall; (g) defects or damage resulting from improper testing, operation, maintenance, installation, service, or adjustment not furnished or approved by GreatCall, including but not limited to installation of unauthorized software and unauthorized root access, both of which shall void this limited warranty; (h) defects or damage resulting from external causes such as collision with an object, fire, flooding, dirt, windstorm, lightning, earthquake, exposure to weather conditions, theft, blown fuse, or improper use of any electrical source; (i) defects or damage resulting from cellular signal reception or transmission, or viruses or other software problems introduced into the Product; or (j) Product used or purchased outside the United States.

This Limited Warranty covers batteries only if battery capacity falls below 80% of rated capacity or the battery leaks. This Limited Warranty does not cover any battery if (a) the battery has been charged by a battery charger not specified or approved by GreatCall for charging the battery; (b) any of the seals on the battery are broken or show evidence of tampering; or (c) the battery has been used in equipment other than the GreatCall device for which it is specified.

What are GreatCall's obligations?

During the applicable warranty period, provided the Product is returned in accordance with the terms of this Limited Warranty, GreatCall will repair or replace the Product, at GreatCall's sole option, without charge. GreatCall may, at GreatCall's sole option, use rebuilt, reconditioned, or new parts or components when repairing any Product, or may replace the Product with a rebuilt, reconditioned or new Product. Repaired/replaced cases, pouches and holsters will be warranted for a period of ninety (90) days. All other repaired/replaced Products will be warranted for a period equal to the remainder of the original Limited Warranty on the original Product or for ninety (90) days, whichever is longer. All replaced Products, parts, components, boards and equipment shall become the property of GreatCall. Except to any extent expressly allowed by applicable law, transfer or assignment of this Limited Warranty is prohibited.

What must you do to obtain warranty service?

To obtain service under this Limited Warranty, please call GreatCall Customer Care at [1-800-733-6632](tel:1-800-733-6632), available between 6 am – 7 pm PST, Mon – Sat, to obtain a warranty authorization number and assistance to determine if you qualify for an advance replacement Product. If GreatCall determines that any Product is not covered by this Limited Warranty, you must pay in full for any advance replacement Product and/or all parts, shipping, and labor charges for the repair or return of such Product.

You should keep a separate backup copy of any contents of the Product before delivering the Product to GreatCall for warranty evaluation and service, as some or all of the contents may be deleted or reformatted during the course of warranty service.

What are the limits on GreatCall's liability?

THIS LIMITED WARRANTY SETS OUT THE FULL EXTENT OF GREATCALL'S RESPONSIBILITIES, AND THE EXCLUSIVE REMEDY REGARDING THE PRODUCTS. ALL IMPLIED WARRANTIES, INCLUDING WITHOUT LIMITATION, IMPLIED WARRANTIES OF MERCHANTABILITY AND FITNESS FOR A PARTICULAR PURPOSE, ARE LIMITED TO THE DURATION OF THIS LIMITED WARRANTY. IN NO EVENT SHALL GREATCALL BE LIABLE FOR DAMAGES IN EXCESS OF THE PURCHASE PRICE OF THE PRODUCT OR FOR, WITHOUT LIMITATION, COMMERCIAL LOSS OF ANY SORT; LOSS OF USE, TIME, DATA, REPUTATION, OPPORTUNITY, GOODWILL, PROFITS OR SAVINGS; INCONVENIENCE; INCIDENTAL, SPECIAL, CONSEQUENTIAL OR PUNITIVE DAMAGES; OR DAMAGES ARISING FROM THE USE OR INABILITY TO USE THE PRODUCT. SOME STATES AND JURISDICTIONS DO NOT ALLOW LIMITATIONS ON HOW LONG AN IMPLIED WARRANTY LASTS, OR THE DISCLAIMER OR LIMITATION OF INCIDENTAL OR CONSEQUENTIAL DAMAGES, SO THE ABOVE LIMITATIONS AND DISCLAIMERS MAY NOT APPLY TO YOU.

GREATCALL MAKES NO WARRANTIES OR REPRESENTATIONS, EXPRESS OR IMPLIED, STATUTORY OR OTHERWISE, AS TO THE QUALITY, CAPABILITIES, OPERATIONS, PERFORMANCE OR SUITABILITY OF ANY THIRD-PARTY SOFTWARE OR EQUIPMENT USED IN CONJUNCTION WITH THE PRODUCT, OR THE ABILITY TO INTEGRATE ANY SUCH SOFTWARE OR EQUIPMENT WITH THE PRODUCT, WHETHER SUCH THIRD-PARTY SOFTWARE OR EQUIPMENT IS INCLUDED WITH THE PRODUCT DISTRIBUTED BY GREATCALL OR

OTHERWISE. RESPONSIBILITY FOR THE QUALITY, CAPABILITIES, OPERATIONS, PERFORMANCE AND SUITABILITY OF ANY SUCH THIRD-PARTY SOFTWARE OR EQUIPMENT RESTS SOLELY WITH THE USER AND THE DIRECT VENDOR, OWNER OR SUPPLIER OF SUCH THIRD-PARTY SOFTWARE OR EQUIPMENT.

Nothing in the Product instructions or information shall be construed to create an express warranty of any kind with respect to the Products. No agent, employee, dealer, representative or reseller is authorized to modify or extend this Limited Warranty or to make binding representations or claims, whether in advertising, presentations or otherwise, on behalf of GreatCall regarding the Products or this Limited Warranty.

This Limited Warranty gives you specific legal rights, and you may also have other rights that vary from state to state.

What is the procedure for resolving disputes?

ALL DISPUTES WITH GREATCALL ARISING IN ANY WAY FROM THIS LIMITED WARRANTY OR THE SALE, CONDITION OR PERFORMANCE OF THE PRODUCTS SHALL BE RESOLVED EXCLUSIVELY THROUGH FINAL AND BINDING ARBITRATION, AND NOT BY A COURT OR JURY.

Any such dispute shall not be combined or consolidated with a dispute involving any other person's or entity's Product or claim, and specifically, without limitation of the foregoing, shall not under any circumstances proceed as part of a class action. The arbitration shall be conducted before a single arbitrator, whose award may not exceed, in form or amount, the relief allowed by the applicable law. The arbitration shall be conducted according to the American Arbitration Association (AAA) Commercial Arbitration Rules applicable to consumer disputes. This arbitration provision is entered pursuant to the Federal Arbitration Act. The laws of the State of California, without reference to its choice of laws principles, shall govern the interpretation of the Limited Warranty and all disputes that are subject to this arbitration provision. The arbitrator shall decide all issues of interpretation and application of this arbitration provision and the Limited Warranty.

For any arbitration in which your total damage claims, exclusive of attorney fees and expert witness fees, are \$5,000.00 or less

("Small Claim"), the arbitrator may, if you prevail, award your reasonable attorney fees, expert witness fees and costs as part of any award, but may not grant GreatCall its attorney fees, expert witness fees or costs unless it is determined that the claim was brought in bad faith. In a Small Claim case, you shall be required to pay no more than half of the total administrative, facility and arbitrator fees, or \$50.00 of such fees, whichever is less, and GreatCall shall pay the remainder of such fees. Administrative, facility and arbitrator fees for arbitrations in which your total damage claims, exclusive of attorney fees and expert witness fees, exceed \$5,000.00 ("Large Claim") shall be determined according to AAA rules. In a Large Claim case, the arbitrator may grant to the prevailing party, or apportion among the parties, reasonable attorney fees, expert witness fees and costs. Judgment may be entered on the arbitrator's award in any court of competent jurisdiction. This arbitration provision also applies to claims against GreatCall's employees, representatives and affiliates if any such claim arises from the Product's sale, condition or performance.

You may opt out of this dispute resolution procedure by providing notice to GreatCall no later than 30 calendar days from the date of the first consumer purchaser's purchase of the Product. To opt out, you must send notice by e-mail to optout@greatcall.com, with the subject line: "Arbitration Opt Out." You must include in the opt out e-mail (a) your name and address; (b) the date on which the Product was purchased; (c) the Product model name or model number; and (d) the IMEI or MEID or Serial Number, as applicable, if you have it (the IMEI or MEID or Serial Number can be found (i) on the Product box; (ii) on the Product information screen, which can be found under "Settings;" (iii) on a label on the back of the Product beneath the battery, if the battery is removable; and (iv) on the outside of the Product if the battery is not removable). Alternatively, you may opt out by sending a letter by certified mail to ATTN: Arbitration Opt Out, GreatCall, Inc., 10945 Vista Sorrento Pkwy #120, San Diego, CA 92130, no later than 30 calendar days from the date of the first consumer purchaser's purchase of the Product and providing the same information. These are the only two forms of notice that will be effective to opt out of this dispute resolution procedure. Opting out of this dispute resolution procedure will not affect the coverage of the Limited Warranty in any way, and you will continue to enjoy the benefits of the Limited Warranty.

Severability If any portion of this Limited Warranty is held to be illegal or unenforceable, such partial illegality or unenforceability shall not affect the enforceability of the remainder of the Limited Warranty.

Safety and Use

We recommend that you read this chapter carefully before using your phone. The manufacturer disclaims any liability for damage, which may result as a consequence of improper use or use contrary to the instructions contained herein.

TRAFFIC SAFETY:

Given that studies show that using a phone while driving a vehicle constitutes a real risk, even when the hands-free kit is used (car kit, headset...), drivers are requested to refrain from using their phone when the vehicle is not parked. Check the laws and regulations on the use of wireless phones and their accessories in the areas where you drive. Always obey them. The use of these devices may be prohibited or restricted in certain areas.

CONDITIONS OF USE:

You are advised to switch off the phone from time to time to optimize its performance.

Remember to abide by local authority rules of mobile phone use on aircrafts.

If your phone is a unibody device, where the back cover and battery are not removable, disassembling the phone will void your warranty. Disassembling the phone can cause bodily injury if the battery is punctured.

Always handle your phone with care and keep it in a clean and dust-free place.

Do not allow your phone to be exposed to adverse weather or environmental conditions, such as moisture, humidity, rain, infiltration of liquids, dust, sea air, etc. The manufacturer's recommended operating temperature range is -20°C (-4°F) to +60°C (140°F).

At over 55°C (131°F), the legibility of the phone's display may be impaired, though this is temporary and not serious.

Do not open, dismantle, or attempt to repair your phone yourself.

Do not drop, throw, or bend your phone.

Use only batteries, battery chargers, and accessories which are recommended by TCL Communication Ltd. and its affiliates and are compatible with your phone model. TCL Communication Ltd. and its affiliates disclaim any liability for damage caused by the use of other chargers or batteries.

Your phone should not be disposed of in a municipal waste.

Please check local regulations for disposal of electronic products.

Remember to make backup copies or keep a written record of all important information stored on your phone.

Some people may suffer epileptic seizures or blackouts when exposed to flashing lights, or when playing video games. These seizures or blackouts may occur even if a person never had a previous seizure or blackout. If you have experienced seizures or blackouts, or if you have a family history of such occurrences, please consult your doctor before playing video games on your phone or enabling a flashing-lights feature on your phone.

Parents should monitor their children's use of video games or other features that incorporate flashing lights on the phones. All persons should discontinue use and consult a doctor if any of the following symptoms occur: convulsion, eye or muscle twitching, loss of awareness, orientation, or movements.

PRIVACY:

Please note that you must respect the laws and regulations in force in your jurisdiction or other jurisdiction(s) where you will use your phone regarding taking photographs and recording sounds with your phone. Pursuant to such laws and regulations, it may be strictly forbidden to take photographs and/or to record the voices of other people or any of their personal attributes,

and reproduce or distribute them, as this may be considered to be an invasion of privacy. It is the user's sole responsibility to ensure that prior authorization has been obtained, if necessary, in order to record private or confidential conversations or take a photograph of another person; the manufacturer, the seller or vendor of your phone (including the carrier) disclaim any liability which may result from improper use of the phone.

BATTERY:

For non-unibody device, where the battery is removable:

- Do not attempt to open the battery due to the risk of toxic fumes and burns;
- Do not puncture, disassemble, or cause a short circuit in a battery;
- Do not burn or dispose of a used battery in the garbage or store it at temperatures above 60°C (140°F).
- Batteries must be disposed of in accordance with locally applicable environmental regulations.
- Only use the battery for the purpose for which it was designed. Never use damaged batteries or those not recommended by TCL Communication Ltd. and/or its affiliates.

For unibody device, where the battery is not removable:

- Do not attempt to eject, replace, or open battery;
- Do not puncture the back cover of your phone;
- Do not burn or dispose of your phone in the garbage or store it at temperatures above 60°C (140°F).

Phone and battery as a unibody device must be disposed of in accordance with locally applicable environmental regulations.



This symbol on your phone, the battery, and the accessories means that these products must be taken to collection points at the end of their life:

- Municipal waste disposal centers with specific bins for these items of equipment;
- Collection bins at points of sale.

They will then be recycled, preventing substances being disposed of in the environment, so that their components can be reused.

In European Union countries:

These collection points are accessible free of charge.

All products with this sign must be brought to these collection points.

In non-European Union jurisdictions:

Items of equipment with this symbol are not to be thrown into ordinary bins if your jurisdiction or your region has suitable recycling and collection facilities; instead they are to be taken to collection points for them to be recycled.

In the United States you may learn more about CTIA's Recycling Program at <http://www.gowirelessgogreen.org/>

CAUTION: RISK OF EXPLOSION IF BATTERY IS REPLACED BY AN INCORRECT TYPE. DISPOSE OF USED BATTERIES ACCORDING TO THE INSTRUCTIONS.

WARNING: This product contains chemicals known to the State of California to cause cancer and birth defects or other reproductive harm.

CHARGERS:

Home A.C./ Travel chargers will operate within the temperature range of: -10°C (14°F) to 50°C (122°F).

The chargers designed for your phone meet the standard for safety of information technology equipment and office equipment use. Due to different applicable electrical specifications, a charger you purchased in one jurisdiction may not work in another jurisdiction. They should be used for this purpose only.

Characteristics of power supply (depending on the country):

Travel charger: Input: 100-240 V, 50/60 Hz, 200 mA

 Output: 5V, 1A

Battery: Lithium 3000 mAh

Radio waves

THIS PHONE MEETS THE GOVERNMENT'S REQUIREMENTS FOR EXPOSURE TO RADIO WAVES.

Your phone is a radio transmitter and receiver. It is designed and manufactured not to exceed the emission limits for exposure to radio-frequency (RF) energy. These limits are part of comprehensive guidelines and establish permitted levels of RF energy for the general population. The guidelines are based on standards that were developed by independent scientific organizations through periodic and thorough evaluation of scientific studies. These guidelines include a substantial safety margin designed to ensure the safety of all persons, regardless of age and health.

The exposure standard for phones employs a unit of measurement known as the Specific Absorption Rate, or SAR. The SAR limit set by public authorities such as the Federal Communications Commission of the US Government (FCC), is 1.6 W/kg averaged over 1 gram of body tissue. Tests for SAR are conducted using standard operating positions with the phone transmitting at its highest certified power level in all tested frequency bands.

This device is complied with SAR for general population /uncontrolled exposure limits in ANSI/IEEE C95.1-1992 and had been tested in accordance with the measurement methods and procedures specified in IEEE1528.

The FCC has granted an Equipment Authorization for this model phone with all reported SAR levels evaluated as in compliance with the FCC RF exposure guidelines. SAR information on this model phone is on file with the FCC and can be found under the Display Grant section of www.fcc.gov/oet/ea/fccid after searching on FCC ID: 2ACCJB083 for 5049S.

Although the SAR is determined at the highest certified power level, the actual SAR level of the phone while operating can be well below the maximum value. This is because the phone is designed to operate at multiple power levels so as to use only the power required to reach the network. In general, the closer you are to a wireless base station antenna, the lower the power output of the phone. Before a phone model is available for sale to the public, compliance with national regulations and standards must be shown.

The highest SAR value for 5049S when tested is 0.55 W/Kg for use at the ear and 1.35 W/Kg for use close to the body.

While there may be differences between the SAR levels of various phones and at various positions, they all meet the government requirement for RF exposure.

For body-worn operation, the phone meets FCC RF exposure guidelines provided that it is used with a non-metallic accessory with the handset at least 15 mm from the body. Use of other accessories may not ensure compliance with FCC RF exposure guidelines.

Additional information on SAR can be found on the Cellular Telecommunications & Internet Association (CTIA) Web site: <http://www.ctia.org/>

The World Health Organization (WHO) considers that present scientific information does not indicate the need for any special precautions for use of phones. If individuals are concerned, they might choose to limit their own or their children's RF exposure by limiting the length of calls, or using "hands-free" devices to keep phones away from the head and body. Additional WHO information about electromagnetic fields and public health are available on the following website: <http://www.who.int/peh-emf>.

Note: This equipment has been tested and found to comply with the limits for a Class B digital device pursuant to part 15 of the FCC Rules. These limits are designed to provide reasonable protection against harmful interference in a residential installation. This equipment generates, uses and can radiate radio frequency energy and, if not installed and used in accordance with the instructions, may cause harmful interference to radio communications. However, there is no guarantee that interference to radio or television reception, which can be determined by turning the equipment off and on, the user is encouraged to try to correct the interference by one or more of the following measures:

- Reorient or relocate the receiving antenna;
- Increase the separation between the equipment and receiver;
- Connect the equipment into an outlet on a circuit different from that to which the receiver is connected;
- Consult the dealer or an experienced radio/ TV technician for help.

Changes or modifications not expressly approved by the party responsible for compliance could void the user's authority to operate the equipment.

For the receiver devices associated with the operation of a licensed radio service (e.g. FM broadcast), they bear the following statement:

Operation is subject to the following two conditions:

- This device may not cause harmful interference;
- This device must accept any interference received, including interference that may cause undesired operation.

Your phone is equipped with a built-in antenna. For optimal operation, you should avoid touching it or degrading it.

As mobile devices offer a range of functions, they can be used in positions other than against your ear. In such circumstances the device will be compliant with the guidelines when used with a headset or usb data cable.

If you are using another accessory ensure that whatever product is used is free of any metal and that it positions the phone at least 15 mm away from the body.

Please note by using the device some of your personal data may be shared with the main device. It is under your own responsibility to protect your own personal data, not to share it with any unauthorized devices or third party devices connected to yours. For products with Wi-Fi features, only connect to trusted Wi-Fi networks. Also when using your product as a hotspot (where available), use network security. These precautions will help prevent unauthorized access to your device. Your product can store personal information in various locations including a SIM card, memory card, and built-in memory. Be sure to remove or clear all personal information before you recycle, return, or give away your product. Choose your apps and updates carefully, and install from trusted sources only. Some apps can impact your product's performance and/or have access to private information including account details, call data, location details and network resources.

Note that any data shared with TCL Communication Ltd. is stored in accordance with applicable data protection legislation. For these purposes TCL Communication Ltd. implements and maintains appropriate technical and organizational measures to protect all personal data, for example against unauthorized or unlawful processing and accidental loss or destruction of or damage to such personal data whereby the measures shall provide a level of security that is appropriate having regard to

- The technical possibilities available;
- The costs for implementing the measures;
- The risks involved with the processing of the personal data, and;
- The sensitivity of the personal data processed.

You can access, review and edit your personal information at any time by logging into your user account, visiting your user profile or by contacting us directly. Should you require us to edit or delete your personal data, we may ask you to provide us with evidence of your identity before we can act on your request.

Licenses



microSD Logo is a trademark.



The Bluetooth word mark and logos are owned by the Bluetooth SIG, Inc. and any use of such marks by TCL Communication Ltd. and its affiliates is under licence. Other trademarks and trade names are those of their respective owners.

TCL LX2 5049S Bluetooth Declaration ID D034867



The Wi-Fi Logo is a certification mark of the Wi-Fi Alliance.

Google, the Google logo, Android, the Android logo, Google Search TM, Google Maps TM, Gmail TM, YouTube, Google Play Store, Google Latitude TM, and Hangouts TM are trademarks of Google Inc.

The Android robot is reproduced or modified from work created and shared by Google and used according to terms described in the Creative Commons 3.0 Attribution License (the text will show when you touch **Google legal** in **Settings > About phone > Legal information**)⁽¹⁾.

You have purchased a product which uses the open source (<http://opensource.org/>) programs mtd, msdosfs, netfilter/iptables and initrd in object code and other open source programs licensed under the GNU General Public Licence and Apache Licence.

We will provide you with a complete copy of the corresponding source codes upon request within a period of three years from the distribution of the product by TCL Communication Ltd.

You may download the source codes from <http://sourceforge.net/projects/tclmobileusa/files/>. The provision of the source code is free of charge from the internet.

⁽¹⁾ May not be available in all countries.

US Information Concerning the Federal Communications Commission (“FCC”) Requirements for Hearing Aid Compatibility with Wireless Devices

When wireless devices are used near hearing devices (such as hearing aids and cochlear implants), users may detect a buzzing, humming, or whining noise. Some hearing devices are more immune than others to this interference, and wireless devices also vary in the amount of interference that they generate.

The wireless telephone industry has developed ratings to assist hearing device users in finding wireless devices that may be compatible with their hearing devices. Not all wireless devices have been rated. Wireless devices that are rated will have the rating displayed on the box together with other relevant approval markings.

The ratings are not guarantees. Results will vary depending on the user’s hearing device and hearing loss. If your hearing device is vulnerable to interference, you may not be able to use a rated wireless device successfully. Consulting with your hearing health professional and testing the wireless device with your hearing device is the best way to evaluate it for your personal needs.

This smartphone has been tested and rated for use with hearing aids for some of the wireless technologies that the smartphone uses. However, other wireless technologies may be used in this smartphone that have not been tested for use with hearing aids. It is important to try the different features of your smartphone thoroughly and in different locations to determine if you hear any interfering noise when using this smartphone with your hearing aid or cochlear implant. Consult your wireless service provider about its return and exchange policies, and for information about hearing aid compatibility.

Hearing aid compatibility rating for this smartphone: M4/T4

How the ratings work

M-Ratings: Wireless devices rated M3 or M4 meet FCC requirements and are likely to generate less interference to hearing devices than wireless devices that are not labeled. M4 is the better or higher of the two ratings.

T-Ratings: Wireless devices rated T3 or T4 meet FCC requirements and are likely to be more usable with a hearing device's telecoil ("T Switch" or "Telephone Switch") than unrated wireless devices. T4 is the better or higher of the two ratings. (Note that not all hearing devices have telecoils in them.)

Hearing devices may also be measured for immunity to this type of interference. Your hearing device manufacturer or hearing health professional may help you find results for your hearing device. The more immune your hearing aid is, the less likely you are to experience interference noise from wireless devices.

For more information about the actions that the FCC has taken with regard to hearing aid compatibility with wireless devices and other steps that the FCC has taken to ensure that individuals with disabilities have access to telecommunications services, visit www.fcc.gov/cgb/dro.

FCC ID for 5049S: 2ACCJB083

SAR

www.sar-tick.com

TCL



This product meets applicable national SAR limits of 1.6 W/kg. The specific maximum SAR values can be found on **Radio waves** section.

When carrying the product or using it while worn on your body, either use an approved accessory such as a holster or otherwise maintain a distance of 15 mm from the body to ensure compliance with RF exposure requirements. Note that the product may be transmitting even if you are not making a phone call.

PROTECT YOUR HEARING

To prevent possible hearing damage, do not listen at high volume levels for long periods. Exercise caution when holding your phone near your ear while the loudspeaker is in use.



WARNING: This product can expose you to chemicals including lead, which is known to the State of California to cause cancer and birth defects or other reproductive harm. For more information go to www.P65Warnings.ca.gov.

Index

Symbols

5Star 7, 21, 23, 30, 38

5Star Button 7, 23, 30, 38

A

Add Contact 43

Airplane Mode 67, 76

All Apps 26, 77, 79

allowance 35, 36

Android Settings 31, 76

app 25, 34, 35, 90

App List 8, 21, 22, 25, 26

B

BACK Button 7, 23
Battery 1, 5, 28
Bluetooth 28, 67, 74, 75
brightness 73

C

Call History 41, 42, 44
Call Volume 41, 50
Camera 13, 25, 59, 60, 61, 62
Cellular Signal Strength 27, 76
Charging 1, 5
Color Theme 67, 80
Contacting Us 67, 82
Contacts 16, 41, 42, 45, 55
Current Date 30
current time 8, 28

D

Data 21, 27, 34, 35, 36

Delete 43, 58

Dial Pad 9, 41, 42, 43, 49

Directions 26, 35

Downloading 35, 67, 77, 78

E

Earpiece Speaker 48

Email 26, 34, 35, 67, 68, 69, 70, 71, 72

F

Facebook 35

Frequently Asked Questions 39

G

Google 35, 77, 78

H

Health & Safety Package 7, 23, 30

HOME Button 7, 23

How-to Cards 39

How-to Videos 39

I

Internet 18, 26, 34, 35, 36, 37, 74

K

keyboard 11, 12

L

Learning Center 1, 21, 39

Lively 26

Lock Screen 21, 29, 30, 31, 32, 33, 67, 81

Lock Screen Photo 67, 81

M

Making a Call 1, 9

Maps 26, 35

N

Navigation Buttons 21, 22, 23

O

Options 8, 24, 25, 32, 33, 57, 58, 65

P

password 19, 33, 37, 68

Password 33

Pattern 32

Phone Settings 18, 26, 27, 28, 31, 37, 73, 74, 76, 80, 81

Photo 1, 13, 53, 57, 59, 60, 61, 63, 64, 65, 67, 72, 81

photos 25, 35, 60, 64, 72

Photos 59, 63, 64, 65

PIN 2, 32, 75

Play Store 77, 109

Power/Lock Button 7, 29, 32

R

Ringer Volume 28, 41, 51

S

Screen Brightness 67, 73

Screen lock 31

Secret Key 31, 33

Shutter button 13, 61, 62

Speakerphone 41, 48, 49

Status Bar 8, 21, 22, 27, 28, 36, 51

Support 26, 34

Swipe 30, 32

T

Talk 12, 21, 34, 55, 56

Text Message 1, 11, 34, 54, 56, 57, 58, 65

Text Messages 10, 25, 53, 54, 55, 56, 58

Title Bar 8, 21, 22, 24, 25

Touch Gestures 1, 6

U

Usage 21, 34, 36

USB Cable 2, 5

V

videos 1, 25, 34, 35, 60, 72

Videos 39, 59, 63, 64

Voicemail 1, 14, 15, 25, 41, 42, 46, 47

Voice Typing 1, 12, 55, 56

Volume Button 7, 28, 50, 51

W

Wall Charger 2, 5

WALLPAPER 81

Wi-Fi 1, 18, 19, 21, 27, 36, 37

Copyright ©2018 GreatCall, Inc. GreatCall®, 5Star®, and GreatCall Link™ are trademarks of GreatCall, Inc. registered and/or pending in the United States and other countries. ©2018 ALCA TEL is a trademark of Nokia used under license by TCL Communication LTD. Screen images simulated. Appearance of device may vary. Other marks are property of their respective owners and may be trademarks.



To learn more, visit greatcall.com/LearningCenter