



**Your roof,
our support.**



BMI Redland



Welcome

Everything we do at BMI Redland is to give housebuilders the certainty, confidence and simplicity they need throughout the entire design, construction and approvals stage of your projects.

The perfect fit of customisation and compatibility, our innovative full systems streamline specification and simplify installation for an easier project, every time.

- 2 Welcome to BMI Redland
- 3 A history built on integrity
- 4 The wider world of BMI
- 6 A partnership of perfect fit
- 7 Challenge accepted
- 8 Full-system thinking
- 9 Covered for choice
- 10 Your project, our people
- 11 At your service
- 12 FixMaster
- 13 Case studies





A history built on integrity

Fraser Avenue, Fife, Campion Homes,
Grovebury in Beckland Brown & Charcoal Grey

From proven heritage to future focus, BMI Redland draws on the expertise and experience gathered from over 100 years as an industry leader.

As part of the BMI Group - one of the world's largest manufacturers of both pitched and flat roofing and waterproofing solutions – we share a commitment to designing high-performance solutions for tomorrow's roofscapes, while delivering technical excellence at every stage.

Why do housebuilders trust BMI Redland?

- Driving the future of pitched roofing and delivering the **perfect fit for over 100 years**.
- A proven, forward-thinking partner **delivering end-to-end support**.
- We continue to evolve, adapt and improve in everything we do – reimagining systems, reframing challenges, and **finding smarter ways to work**, every day.
- We provide full systems and a **'one-stop shop'** that simplifies supply chains.
- Our partners have access to a comprehensive range of **free technical services**.
- Our technical teams and specification tools give housebuilders **outstanding support** at every stage.
- **World-leading testing facilities** go above and beyond national standards, and specifically focus on meeting the unique challenges of British roofing.
- We're committed to **training and development** for all our partners, online, on-site and with the BMI Academy.
- We're committed to supporting the **next generation of roofing excellence**.



Above and beyond The wider world of BMI

At BMI Redland, we're specialists in pitched roofing systems you can rely on. But, as part of the BMI Group, there's a whole world of systems, solutions and technologies to fulfil every need across both pitched and flat roofing – delivering excellence on every project.

Flat roofing

- **Bitumen** systems, ideal for metal decking, timber or concrete substrates
- **Noxite** bituminous membranes to deliver high-quality flat roofs that remove harmful airborne pollutants
- Durable, self-healing **hot melt** systems to last the lifetime of a building
- **Liquid applied waterproofing**, delivering seamless curing for a reliable, flexible roof
- **Single-ply** solutions for high-performance, lightweight and versatile results
- **Active roofs** to enhance sustainability, biodiversity and our living environment
- **Rooflights** to help ensure optimum natural light in rooms for both health and economic benefits



Mitsubishi Electric factory, West Lothian: BMI Icopal Thermosolo roof system (advanced SBS bitumen) and rooflights



Rooftop running track at White Collar Factory offices and apartments building, London: BMI Icopal Parabit Hot Melt Waterproofing System and Thermazone Hydroshield Inverted Roof Insulation

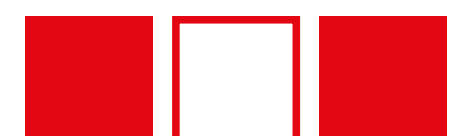

Above and beyond The wider world of BMI

Construction products

- **Unrivalled sound reduction for walls and floors** with a range of acoustic floors and unique flanking systems
- **Structural waterproofing membranes** that provide high performance protection
- **Gas and radon barrier systems** with a comprehensive range for both commercial and domestic applications
- **Scaffold sheeting and temporary roof coverings** to protect your project from the elements



Creekside Wharf build-to-rent development, Greenwich: BMI Monarfloor acoustic wall and floor systems



Marlborough College, Wiltshire: BMI Monarflex Temporary Roof Covering system

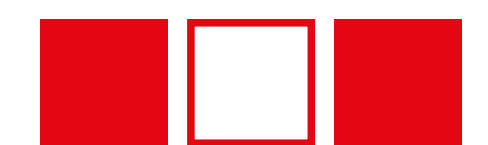

A partnership of perfect fit

New-build projects can be hugely complex, with multiple stakeholders and suppliers involved. We understand that bringing a development to completion on time, in full and on budget is critical – which is why we're here to make life easier.

From initial design to final sign-off, we understand that now, more than ever, housebuilders need total reassurance from start to finish. Then, of course, there's the need to perfectly balance ease and simplicity with quality, value and performance, all in one seamless solution.

That's why our approach to housebuilding projects is rooted in full-system thinking, where every tile, every component and every system works perfectly together every time. In doing this, we provide the certainty and confidence you need today, tomorrow, and long into the future – all in one package of perfect fit.



Keeper's Cottage, Kent, JP Whelan Homes,
Rosemary Clay Classic in Russet Mix & Medium Mixed Brindle



Challenge accepted

We understand that the pressure on housebuilders to deliver first-class projects at the first time of asking has never been greater.

We also appreciate you're facing a host of challenges – some new, some familiar – that need to be solved to secure project success. It's here that our 100 years of experience and knowledge enable you to tackle these issues head on.



YOUR CHALLENGE

Staying up-to-date with compliance and regulations specifics and changes

Meeting all planning permissions and pre-commencement conditions

Risk of delays/call-backs/rectification affecting timescales, budgets and reputation

Fragmentation and complexity in the supply chain

Supply and availability issues

Access to emerging technologies and being able to meet increased demands for solar photovoltaic systems

Increasing education, skills and knowledge gaps

OUR SOLUTION

From in-person support to compliance guidance, our team works with you - online, offline and on-site - in a partnership of perfect fit.

Access to a dedicated housebuilder team that provides stage-by-stage support to eliminate any unexpected surprises

Our team acts as an extension of yours through the whole project to minimise call-backs or customer complaints

We offer a single-source supply of systems that are fully tested, validated and compatible

Our 'one-stop shop' approach results in a greatly simplified supply chain, alongside robust product availability across the UK

Our ever-evolving product range includes an in-roof PV system that's compatible with concrete, clay and slate tiles

We provide specialist expertise in pitched roofing, alongside industry-leading training at the BMI Academy

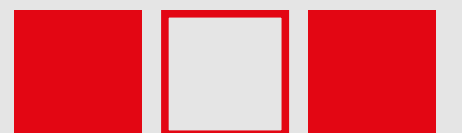

One system, one supplier, one contact

When it comes to housebuilding projects, our approach is rooted in full-system thinking, with every component precisely designed, tested and validated to complement each other.

The perfect fit of customisation and compatibility, these systems streamline specification, simplify installation and deliver long-term performance and a right-first-time solution.



MEET THE MAGNIFICENT SEVEN

We've been working with housebuilders for decades – so we know what works for them, right down to the components they use. Components like our 'Magnificent Seven', that have been integral to countless housing projects over the years.

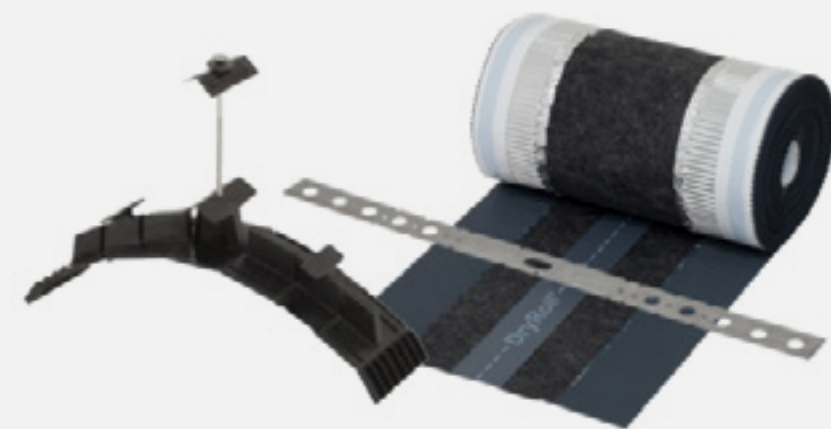

1 Uni-Vent Rapid Ridge/Hip



2 Hip Support Tray

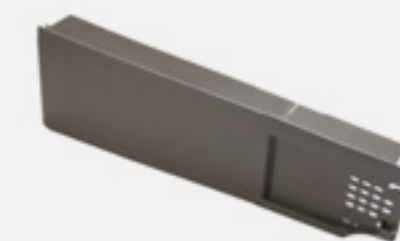

3 Rapid Dry Verge



4 Rapid Dry Verge Gable End Packs

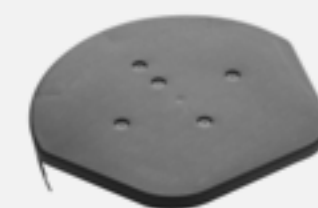

5 Ridge End Caps

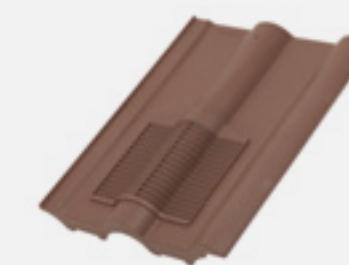

6 Rapid Roof Vent Tile



7 Clips: Eaves Clips, Verge Clips and Innofix Clips



Covered for choice

Roofing is about achieving the perfect fit. Tile to tile, component to roof detail, specification to solution.

Whether new build or refurb, the roof is integral to any building's performance. So, it's essential that every stage of your project is carefully managed – and our team join you on-site to undertake site inspections and monitoring installation, ensuring your roofs are completed accurately and compliantly, to specification, on time and to your satisfaction.

Of course, aesthetics also plays a big part, which is why we offer a comprehensive range of solutions carefully designed, tested and manufactured to give value, visual appeal and long-lasting performance. From recycled natural slate and traditional clay to concrete or in-roof photovoltaic systems, we've got you covered.



Confidence in compliance

No BMI Redland system gets on the roof without passing a comprehensive programme of stringent tests in our world-leading testing, research and validation centre. Our roofing and waterproofing systems are also designed specifically for the UK climate and to continually meet the unique demands of our changing weather, conditions and industry standards.



Integrated Solar PV

An integrated Solar PV roofing solution can significantly reduce the carbon emissions of a development when compared to other methods and technologies. Our in-roof photovoltaic systems match performance with aesthetics, and can be easily installed on new build or retrofit projects – and our experts will also ensure they deliver a lifetime of performance and value to your project.

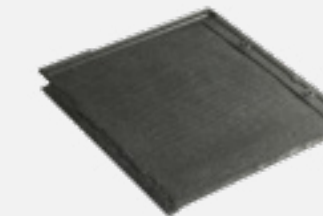

Cambrian Slate

The beauty of natural slate, engineered to be lighter, faster and easier to install. With a long lifespan of lower maintenance, Cambrian recycles responsibly rescued Welsh slate into a high-integrity tile that combines aesthetics and performance in one complete system, with complete support, for complete simplicity from start to finish. Beautifully simple.

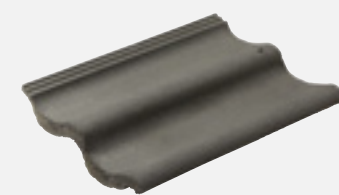

Concrete

Our range of concrete flat interlocking, profiled and plain tiles are quick and easy to lay and offer great versatility and scope for varied effects. Suited to almost any pitched roof design, they produce striking roofs of timeless quality.



Rosemary Clay

Some solutions are better by nature. That's always been the philosophy behind Rosemary, and why it's endured on Britain's rooftops since 1837. Produced from the finest Etruria Marl clay, Rosemary is offered in a range of weathered, brindled and single colours that create striking and attractive roofs.

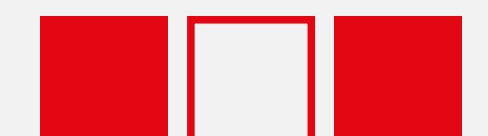
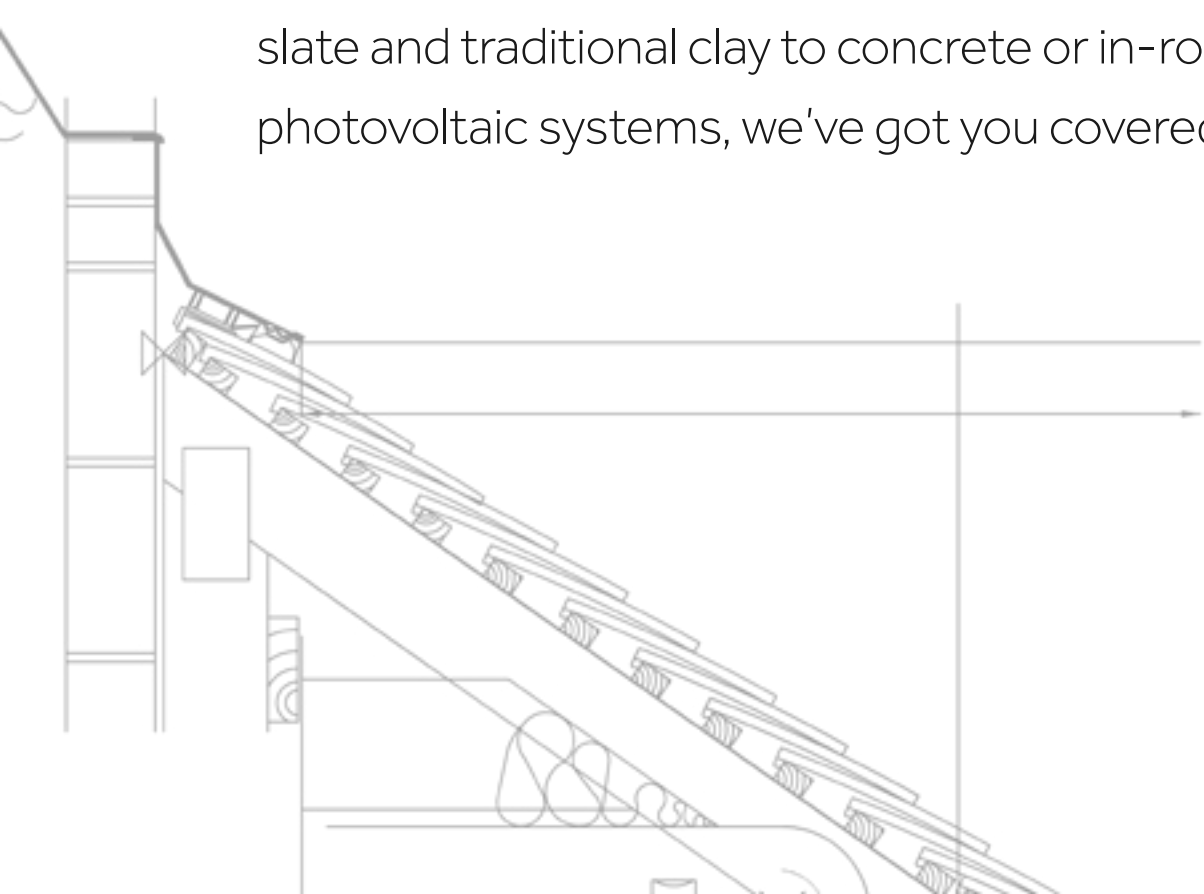

Your project, our people

We want to ensure your roofing project is delivered to the highest possible standards, which is why our team acts as an extension of your own to maximise the performance, protection and profitability of your project.

With guidance, problem-solving, inspections and training available, we're on hand to support you with everything including design advice and calculations, supply chain management, product and technical support, and tips for safer, faster, easier installation.

Our world of support includes:

- An extensive range of time-saving technical roof tools
- A dedicated account manager
- Specification writing
- Best-in-class training at the BMI Academy
- RIBA-approved CPDs
- Solar calculations
- Roof surveys, site inspections and monitoring



BMI Academy National Training Centre



Taylor Wimpey customised training day at the BMI Academy

Precision-targeted training

It's vital that everyone involved in the roofing aspect of the housebuilding project cycle should be up to date on the latest regulations, techniques and systems.

So, as part of our world-class BMI Academy, we offer specialised training for housebuilders and their teams, giving you the most comprehensive understanding of pitched roofing best practice, from concepts to components, compliance to commercial performance.

With an engaging mix of theory and practical programmes, including RIBA-approved CPDs, installation training and estimating courses, the BMI Academy offers indispensable training for everyone, at every level, with a firm focus on the needs and nuances of the housebuilding sector.



At your service

We've developed a comprehensive range of free tools and technical services for housebuilders that will save you time and give you complete peace of mind that your project is in safe hands.

Fast, convenient and simple to use, these tools will help you navigate our extensive product selection and determine the exact tiles, components and fixings required for your pitched roof design. Furthermore, to ensure maximum safety standards are upheld and remove any design liability our free pitched roofing services have been created using our extensive knowledge of British roofing regulations, UK wind zones, research and testing.



Gerards Cross, Cala Homes, Plain Tile in Rustic Red & Rosemary Clay Craftsman in Hawkhurst

OUR TECHNICAL SUPPORT AND ROOFING SERVICES:



BIM

A library of BIM objects that includes data and safety requirements to ensure projects meet NBS standards.



SpecMaster

A free pitched roof specification service with NBS-based clauses - available with our 15-year Redland whole roof guarantee.



FixMaster

An online fixing specification service tailored to every pitched roofing project.



EcoMaster

Ensure the highest levels of safety and performance for Solar PV projects with our guaranteed specification service.



DesignMaster

Save valuable time with a comprehensive CAD library of 4000+ quality roof detail drawings.



QuantMaster

Speed up the estimating process with our bespoke pitched roof materials quantity estimation service.



NBS Source

Quickly and accurately complete project specs by directly selecting and importing product information.



Sample Request

Offering a choice of roof tile samples from our market-leading range of concrete, clay and slate tiles.

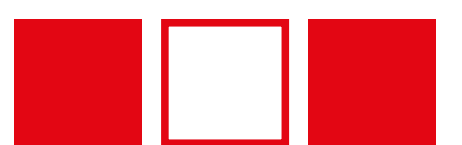

Safe and secure



Finding the correct roof tile fixing specification should be a quick and seamless process. Our efficient free-of-charge FixMaster service speeds up the specification process, allowing users to determine the correct tile and slate fixings in just seven simple steps.



When wind blows over a roof, uplift forces act on both the underlay and the tiles. The roof system has to be designed to withstand these forces for the design life of the building, typically 50 years. To account for this, roof coverings must be fixed in accordance with BS 5534:2014+A2:2018 and a fixing-spec is one of the most important parts of ensuring a safe and secure roof.

A new fixing specification must be created for every project to avoid risks to liability, meet current standards and take all relevant factors into account from roof and tile-type to geometry, location and exposure. By including a documented fixing specification, housebuilders can reduce the risk of inadequate fixing and therefore potential future callbacks or claims.

Safe, high performing roof fixings for your project

Our simple-to-use service ensures that your chosen pitched roof fixings are fully compliant with British Standards. Not only does FixMaster ensure the highest safety and quality standards are delivered, but our roof tile fixing specification tool also takes all relevant factors into account, providing you with a reference document to be used for on-site supervision and checks before each property is signed-off.

roofing specs in minutes. You can instantly download your fixing spec or log back in at any time to view any fixing specifications you've created.

Redland supply a comprehensive range of fixings for our range of tiles including nails, screws and clips. These fixings are designed specifically for Redland tiles and are manufactured from quality materials to comply with codes of practice.

With a simple step-by-step process, FixMaster means you can create new



Beaufort Park & Middleton Park

Norfolk

CONTRACTOR

Essex Roofing

DEVELOPER

Taylor Wimpey

SYSTEM

**Fenland Pantile in Breckland Brown,
Farmhouse Red & Slate Grey**

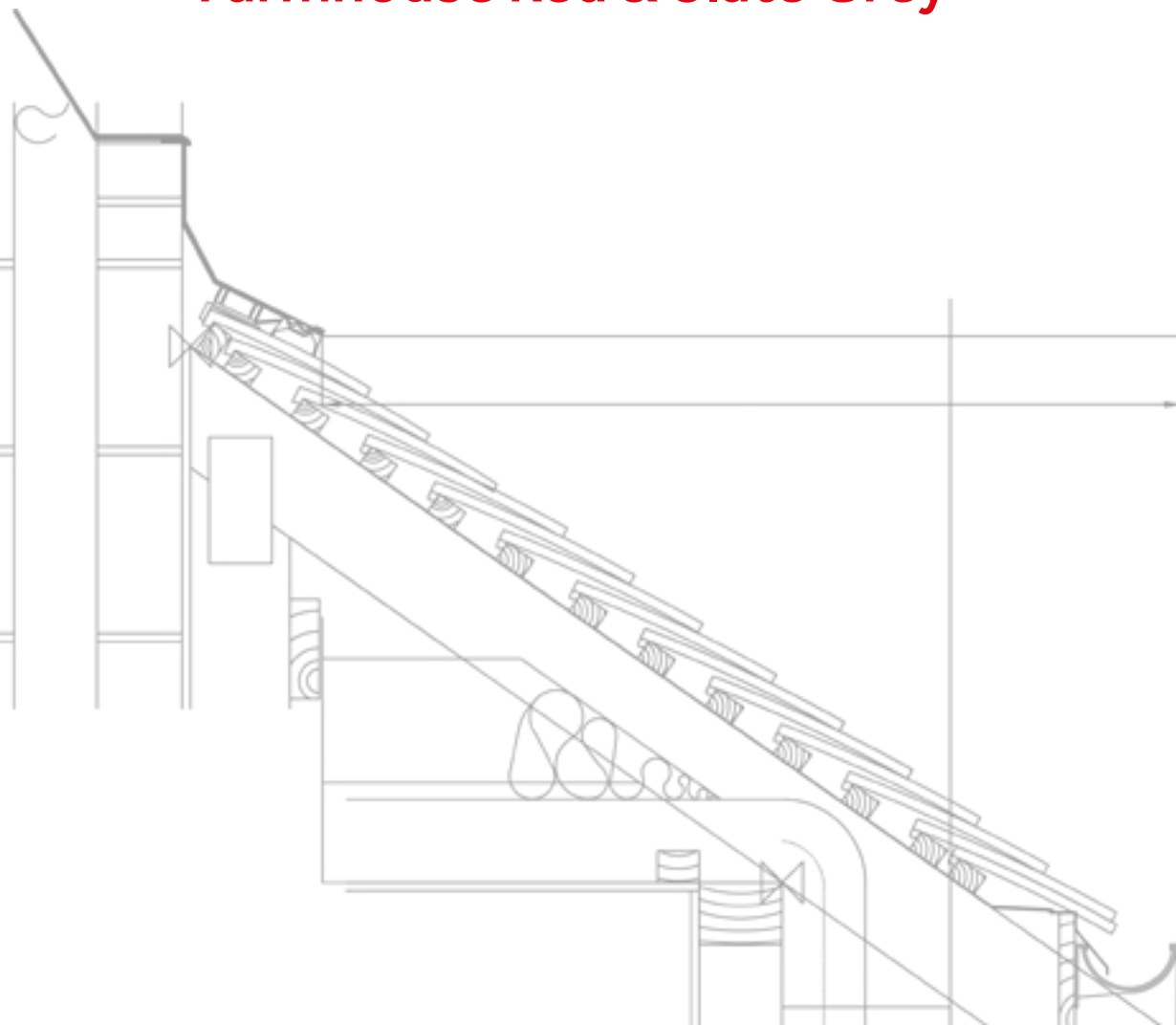

Modern tiles, traditional appearance

A new build housing development in Norfolk that was built as an idyllic escape for growing families.

CHALLENGE

Based in a quiet area with stunning beaches and sweeping woodland, the new build development needed to match the aesthetic of the area while being cost effective to install.

SOLUTION

BMI Redland's Fenland Pantile was used throughout both the developments in Beaufort Park and Middleton Park.

Gary Drage, Branch Manager at Essex Roofing, who carried out the roofing works said *"We have used BMI Redland tiles on numerous projects in the past and have found them to be reliable and consistent, and our customers are happy with the results."*

“

We have a long standing relationship with BMI Redland and they are one of our preferred roof tile suppliers. We chose the Fenland Pantile because it most closely matched the roofs in the surrounding areas and we feel it is important to maintain the architectural identity of small towns like the ones where Beaufort Park and Middleton Park are situated. ”

ANDREW RODZIAN, PROJECT MANAGER, TAYLOR WIMPEY

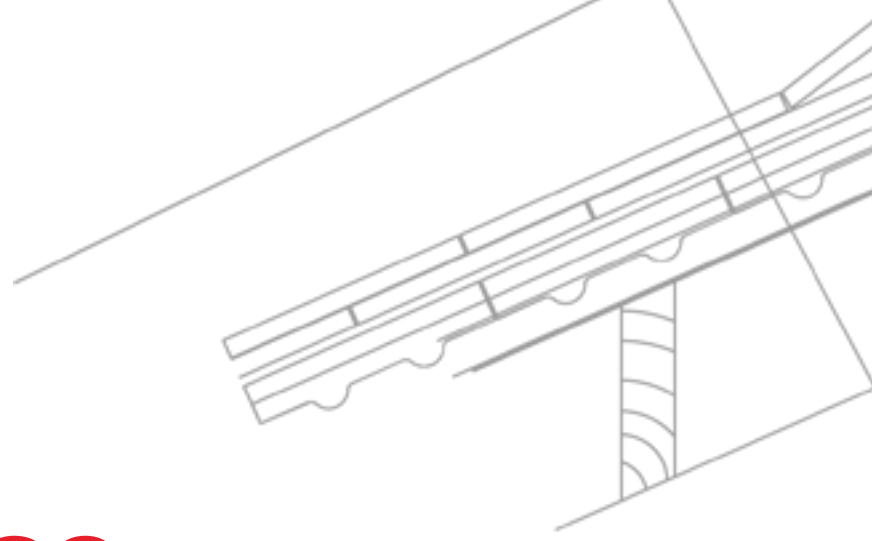

Case Study

Willow Tree

Hook Norton, Oxfordshire

CONTRACTOR

Bicester Roofing

DEVELOPER

Willow Tree Developments

SYSTEM

Rosemary Clay Classic in Burnt Blend

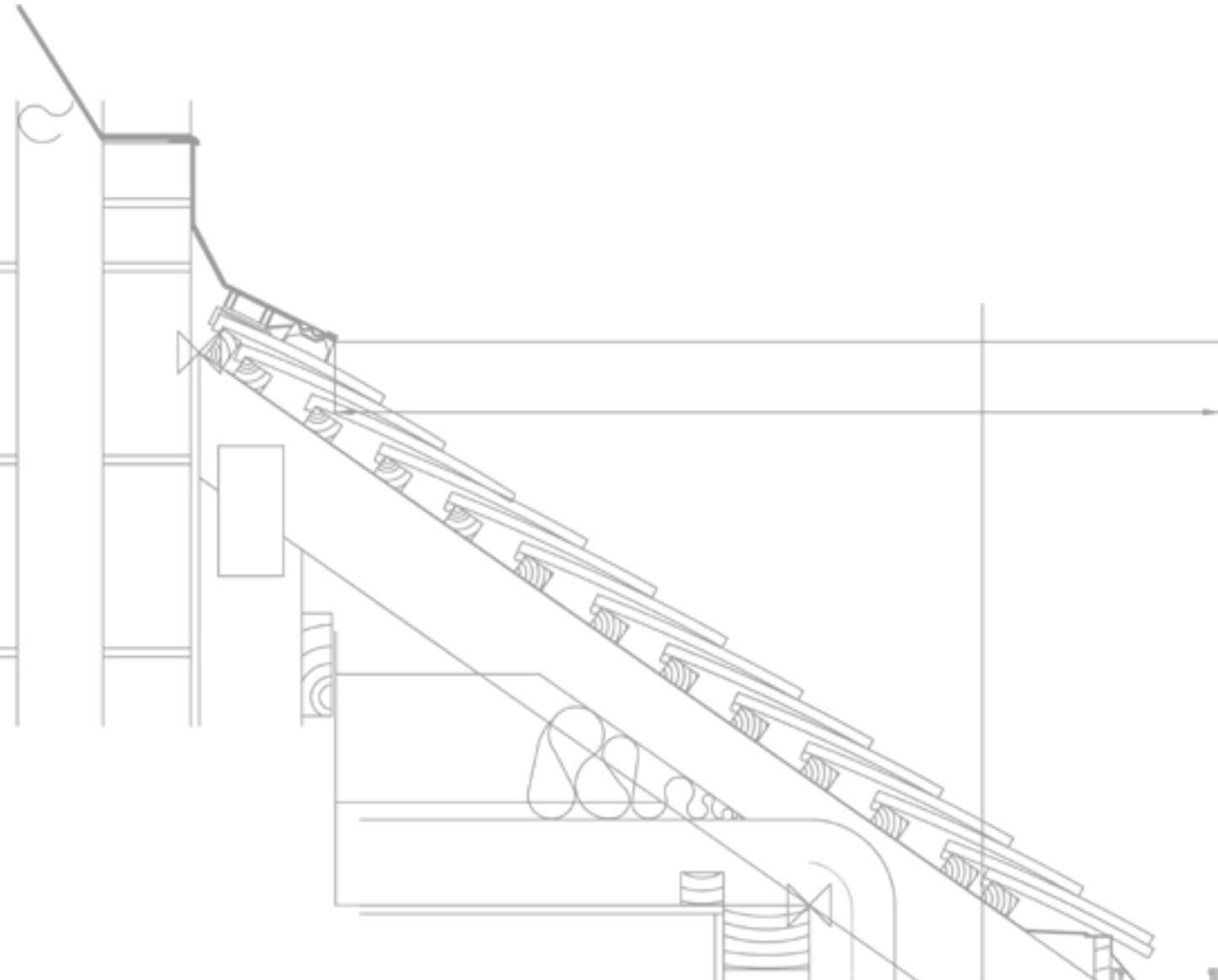

A fit for the local area

Roofing for a desirable new-build residential development in the heart of Oxfordshire.

CHALLENGE

Willow Tree is an exclusive estate comprising four, luxury homes. As with any high-end project, there was a focus on maximising appeal and return on investment, with every decision negotiating a careful balance between quality and cost. Willow Tree Developments and Bicester Roofing worked with BMI Redland to find a solution for delivering outstanding aesthetics, cost-effectively for the 100m² properties. There was also the need to navigate planning; helping secure permission by proving the integrity and suitability of the roofing system, particularly with regard to sensitivity to the local area.

SOLUTION

BMI Redland's Fenland Pantile was used throughout both the developments in Beaufort Park Working with Willow Tree and Bicester Roofing, the BMI Redland team matched the quality of the system to the quality of workmanship and design. The Rosemary Clay Classic plain tile in Burnt Blent was chosen to create a set of beautiful roofs that would work in harmony with the distinctive aesthetic of the local area and satisfy planning requirements.



On a project like this, quality control is essential - both in the products we use and the installation itself. Here, we had a phenomenal result, mainly in how the Rosemary roof tiles complement the aesthetics of the local area, but also the level of finish. It's been a great project all round.

DAVID DYSON, DIRECTOR, WILLOW TREE DEVELOPMENTS

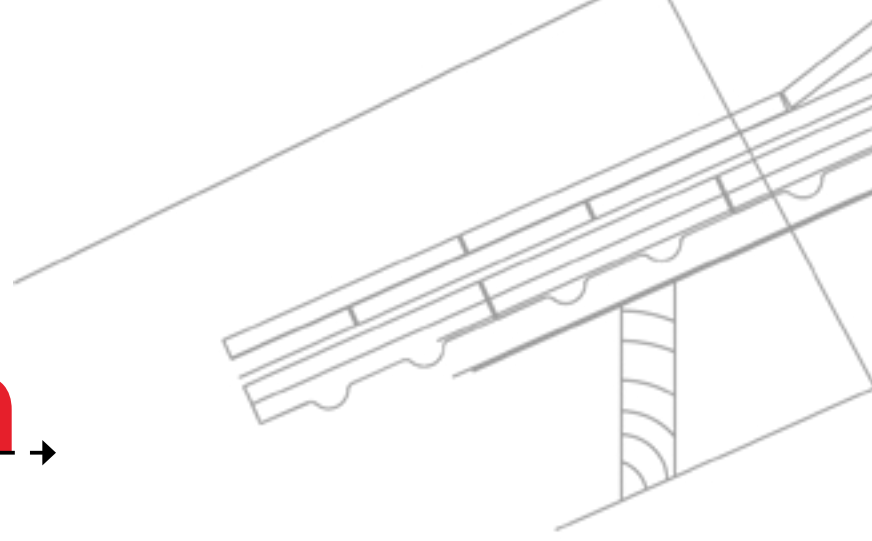

Perfect fit. Big impact.

Everything we do at BMI Redland is built around helping you bring developments to completion on time, in full and on budget. Get in touch with our experienced technical services team today to see how the perfect fit of your roof and our support can make a big impact on your next project.

Visit our website here:

bmigroup.com/uk

Contact our Technical Services team about your project today:

0330 123 4585

technical.redland@bmigroup.com

Contact Customer Services:

0370 560 1000

sales.redland@bmigroup.com

