









Connector	60° Cone Angle	75° Cone Angle	90° Cone Angle
ISO 9404-1-31.5-2-M5	 SG.4C.60D.31	 SG.4C.75D.31	 SG.4C.90D.31
ISO 9409-1-40-4-M6	 SG.4C.60D.40	 SG.4C.75D.40	 SG.4C.90D.40
ISO 9409-1-50-4-M6	 SG.4C.60D.50	 SG.4C.75D.50	 SG.4C.90D.50
Typical Gripping Objects	<ul style="list-style-type: none"> • Rectangular or Cubic • Feed size 15 mm – 115 mm • Weight < 400 g 	<ul style="list-style-type: none"> • Rectangular or Cubic • Feed size 10 mm – 90 mm • Weight < 400 g 	<ul style="list-style-type: none"> • Rectangular or Cubic • Feed size 5 mm – 40 mm • Weight < 400 g



4 x Finger Shore A60
SG.F60S



1 x Vacuum Suction Cup
(optional accessory)

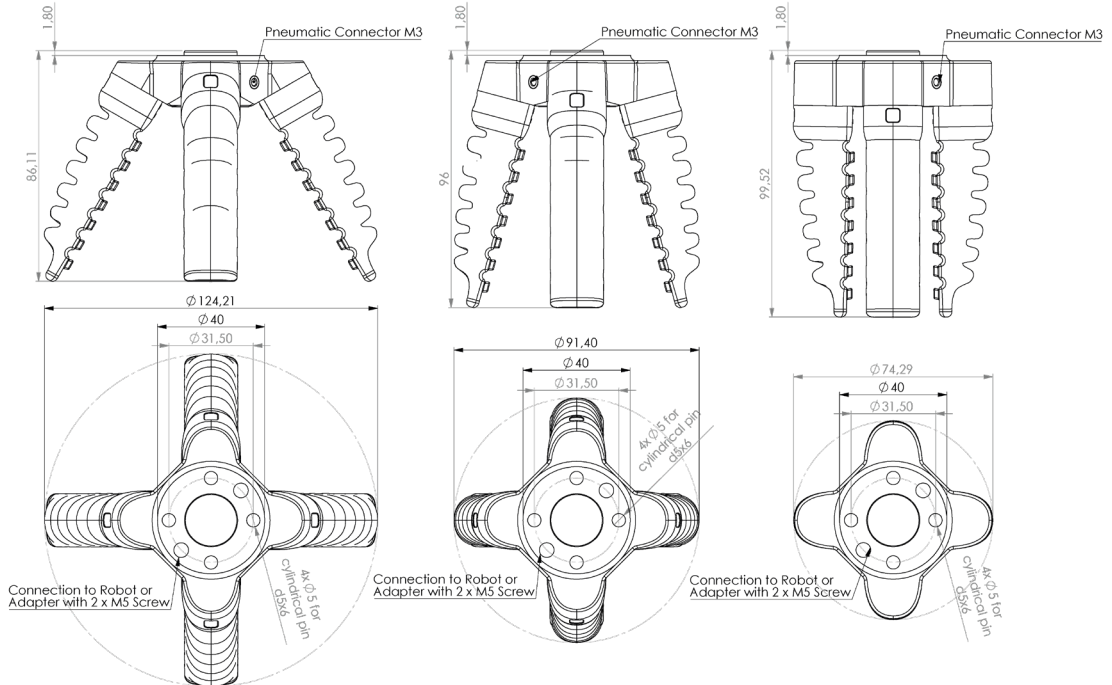

Finger Material	Silicone
Operating Pressure	- 0.5 to 1.0 bar
Grip Force per Finger	3,5 N
Durability	> 1 Mio. Cycles @1.0 bar, 0.5 Hz
Connector ¹	ISO 9404-1-31.5-2-M5
Air Pressure Connection	2 x M3
Total Height 60° 75° 90°	68,11 96,00 99,52 mm
Total Diameter 60° 75° 90°	124,21 91,40 74,29 mm
Mass	383 g

¹ Other connectors available, e.g. ISO 9409-1-50-4-M6 for Universal Robots.

Available SoftGripper Adapters

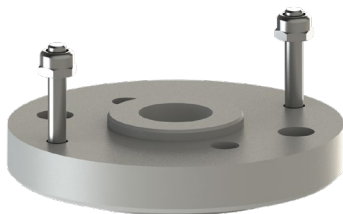

RBTX Delta Robot Connector
SG.C.31.NE.17



ISO 9409-1-40-4-M6 Connector
SG.C.31.40



ISO 9409-1-50-4-M6 Connector
SG.C.31.50